



Collective Thomson scattering by using a 77GHz gyrotron for bulk and fast ion measurements in LHD

Tanaka, K.; Nishiura, M.; Kubo, S.; Shimozuma, T.; Kawahata, K.; Mutoh, T.; Igami, H.; Yoshimura, Y.; Takahashi, H.; Saito, T.

Total number of authors:
15

Publication date:
2011

Document Version
Publisher's PDF, also known as Version of record

[Link back to DTU Orbit](#)

Citation (APA):

Tanaka, K. (Invited author), Nishiura, M. (Invited author), Kubo, S. (Invited author), Shimozuma, T. (Invited author), Kawahata, K. (Invited author), Mutoh, T. (Invited author), Igami, H. (Invited author), Yoshimura, Y. (Invited author), Takahashi, H. (Invited author), Saito, T. (Invited author), Tatematsu, Y. (Invited author), Ogasawara, S. (Invited author), Korsholm, S. B. (Invited author), Meo, F. (Invited author), & Stejner Pedersen, M. (Invited author). (2011). Collective Thomson scattering by using a 77GHz gyrotron for bulk and fast ion measurements in LHD. Sound/Visual production (digital)

General rights

Copyright and moral rights for the publications made accessible in the public portal are retained by the authors and/or other copyright owners and it is a condition of accessing publications that users recognise and abide by the legal requirements associated with these rights.

- Users may download and print one copy of any publication from the public portal for the purpose of private study or research.
- You may not further distribute the material or use it for any profit-making activity or commercial gain
- You may freely distribute the URL identifying the publication in the public portal

If you believe that this document breaches copyright please contact us providing details, and we will remove access to the work immediately and investigate your claim.

Collective Thomson scattering by using a 77GHz gyrotron for bulk and fast ion measurements in LHD

K.Tanaka ^{1*}, M. Nishiura¹, S. Kubo¹, T. Shimosuma¹, K.
Kawahata¹, T. Mutoh¹, H. Igami¹, Y. Yoshimura¹, H.
Takahashi¹, T. Saito², Y. Tatematsu², S. Ogasawara³, S.B.
Korsholm⁴, F. Meo⁴, M. Stejner⁴ LHD experiment group

¹ *National Institute for Fusion Science,*

² *FIR FU, University of Fukui,*

³ *Department of Energy Science and Technology, Nagoya University,*

⁴ *Association EURATOM-Risø DTU, P.O. Box 49, DK-4000 Roskilde, Denmark*

Large Helical Device

12m

$R=3.5-4.1\text{m}$, $a\sim 0.6\text{m}$

$B_t=2.9\text{T}$ Max

15MW Para. N-NB

10MW Perp. P-NB

3MW 77GHz ECRH

2MW ICRH

Plasma

Helical winding coil

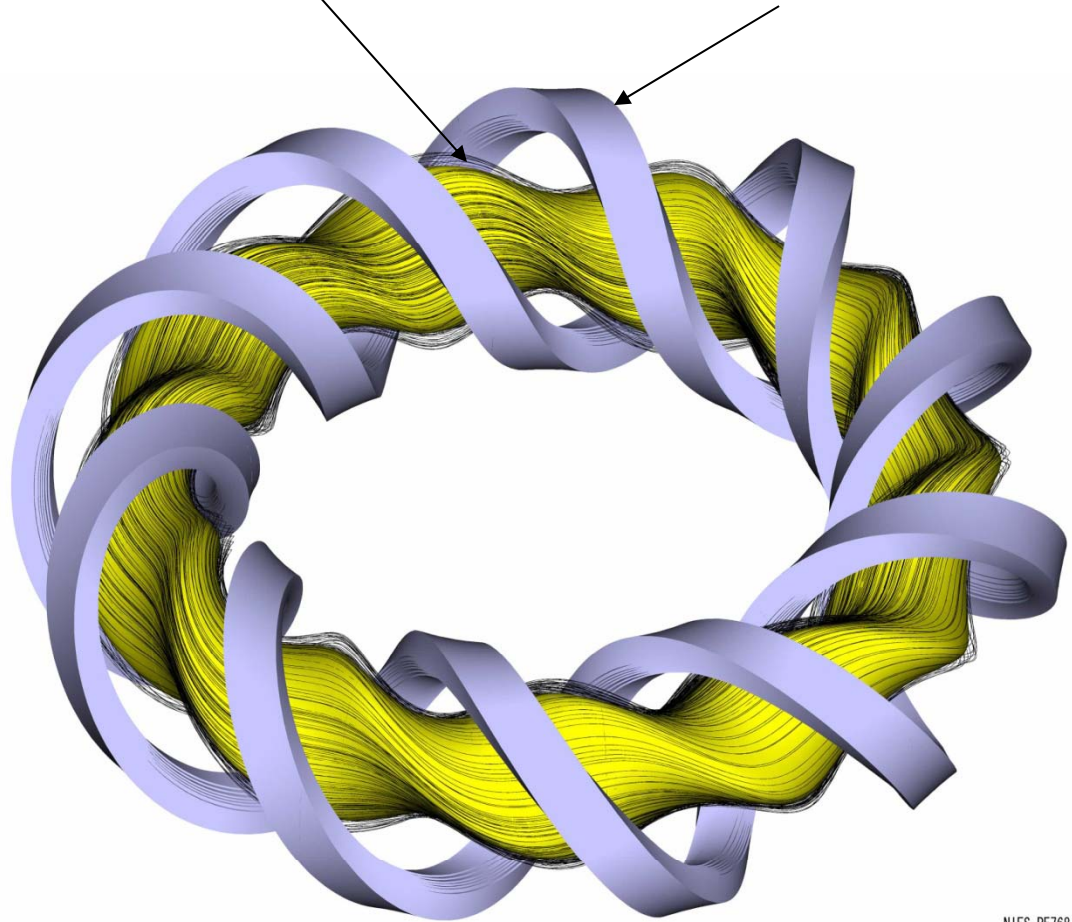

NIFS-PE768

External coils can sustain magnetic flux surface stationary.

This is a strong advantage for the steady state operation.

Particularity of magnetic configuration in LHD is additional magnetic ripple. This enhances bulk and fast ion transport.

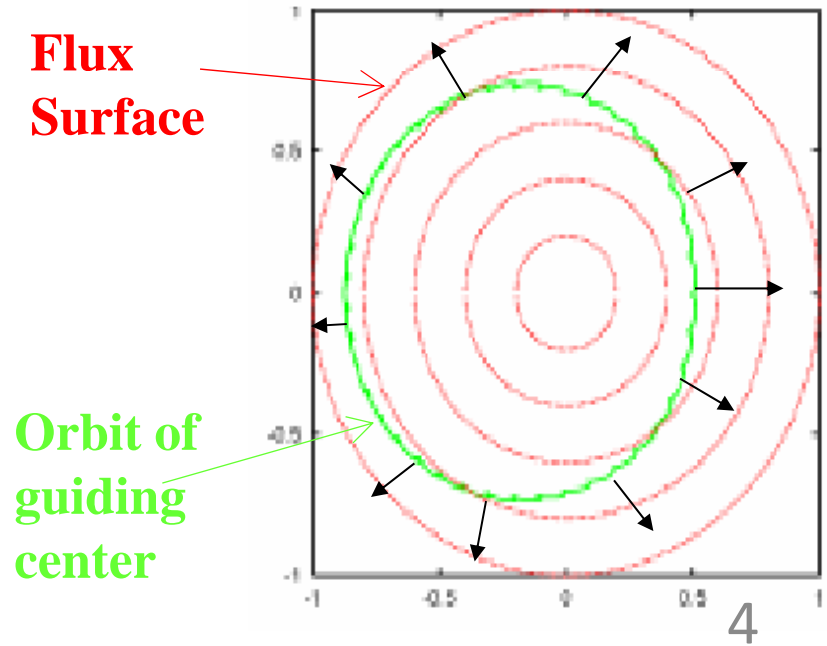
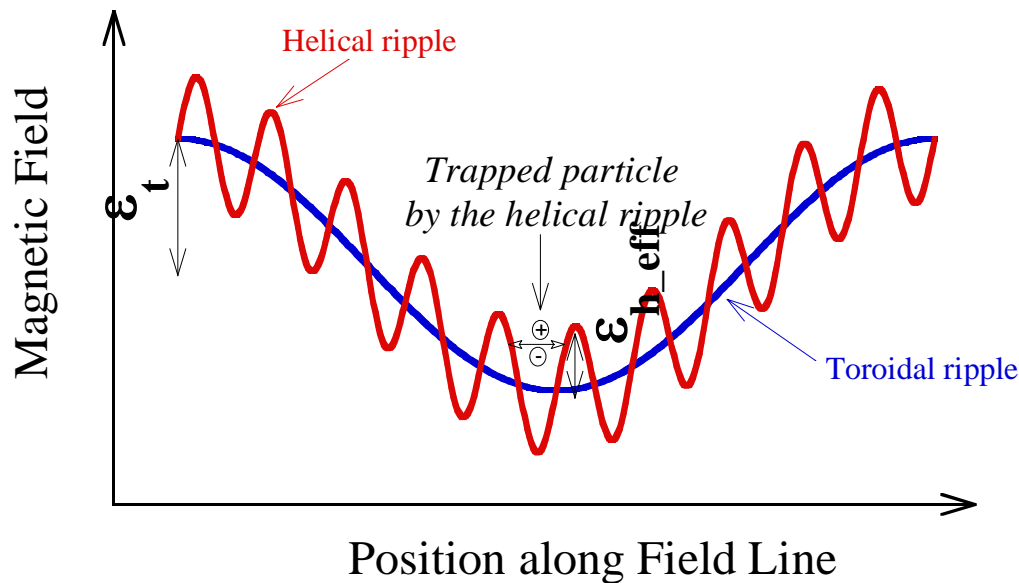
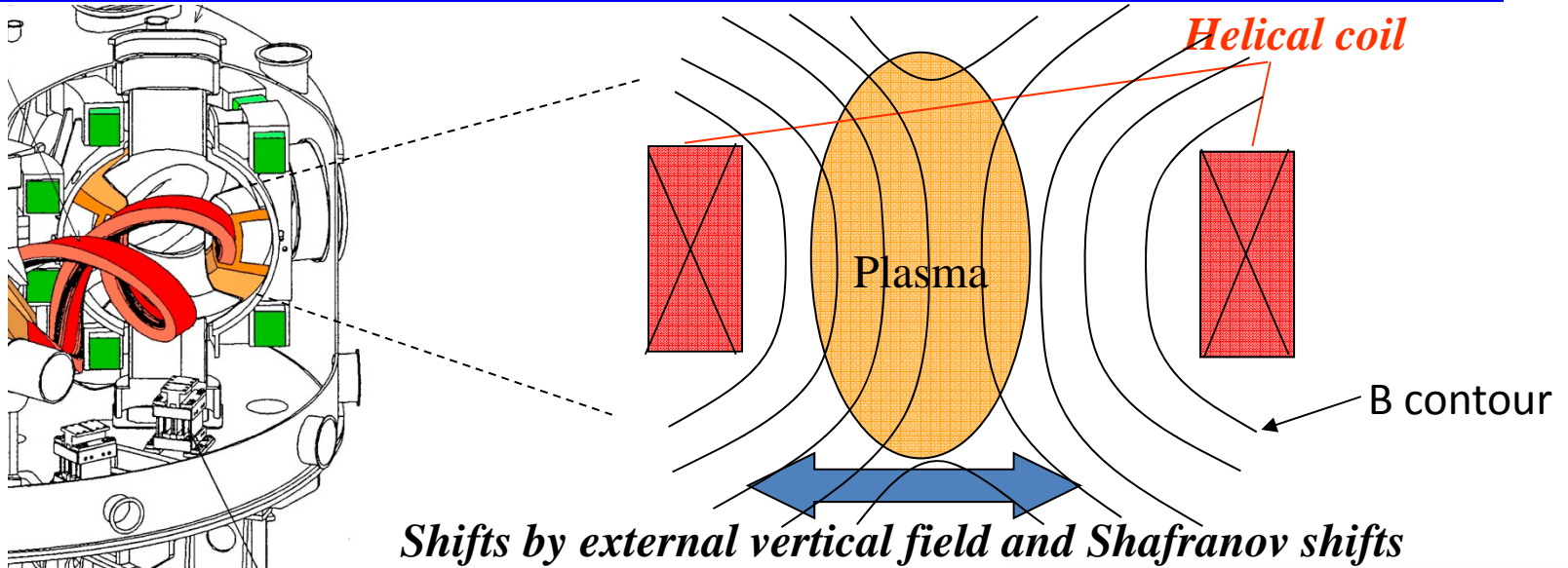

Outline

1. Introduction of collective Thomson scattering (CTS)
2. CTS system in LHD
3. Experimental results
4. Summary

Introduction to Collective Thomson Scattering (CTS)

Collective scattering means scattering of electro magnetic wave by collective motion of electron

Scattering condition

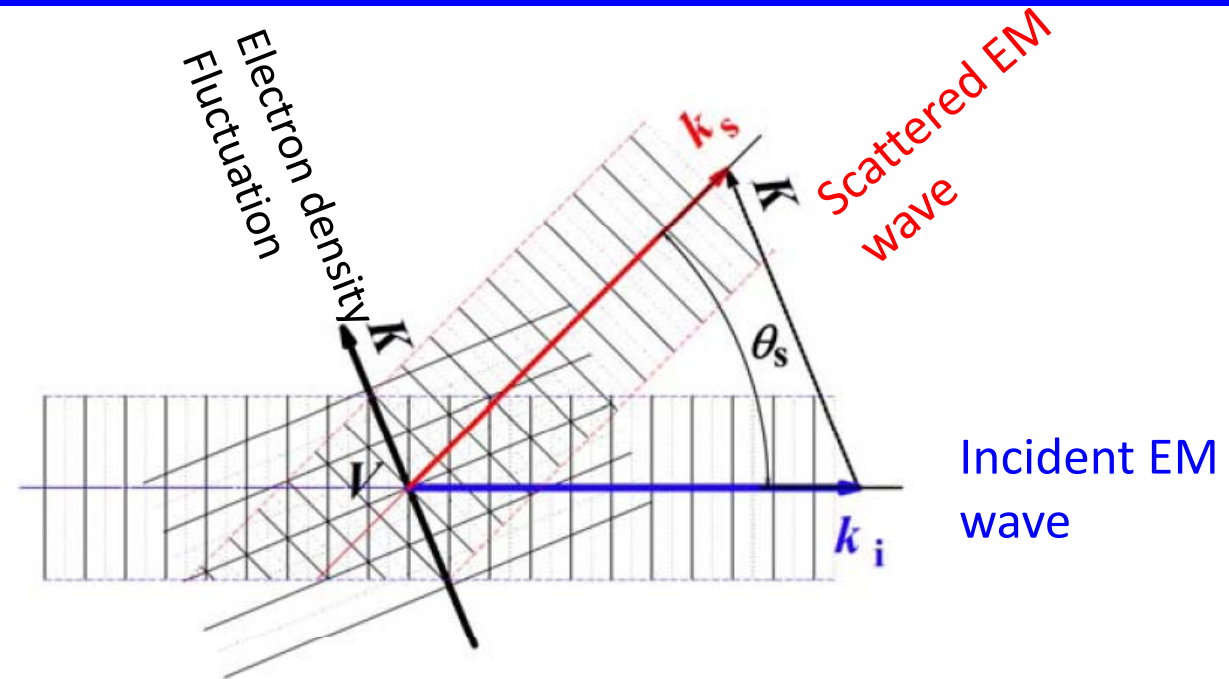

Bragg condition $2k_i \cos\left(\frac{\theta_s}{2}\right) = K$ should be satisfied.

Collective motion of electrons is due fluctuations caused by instability
→ study of macro or micro instability are possible

It is also due to the electron motions shielding local charge of ion (Debye shielding
→ Ion moves thermally, thus, information of ion thermal motion can be extracted

What CTS measures?

Fast ion measurements are weighted by CTS.

Future Exp.

Bulk ion

Fast ion

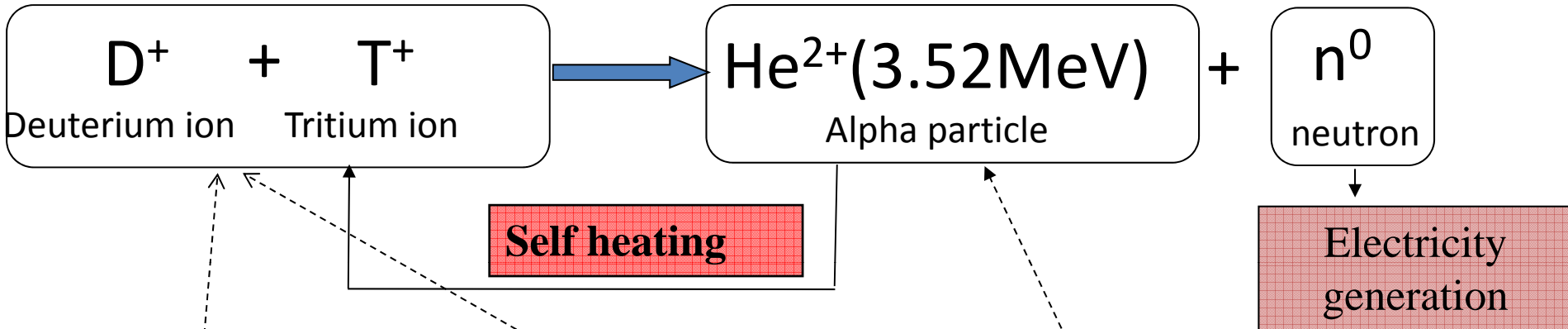

Present Exp.

Bulk ion

Fast ion

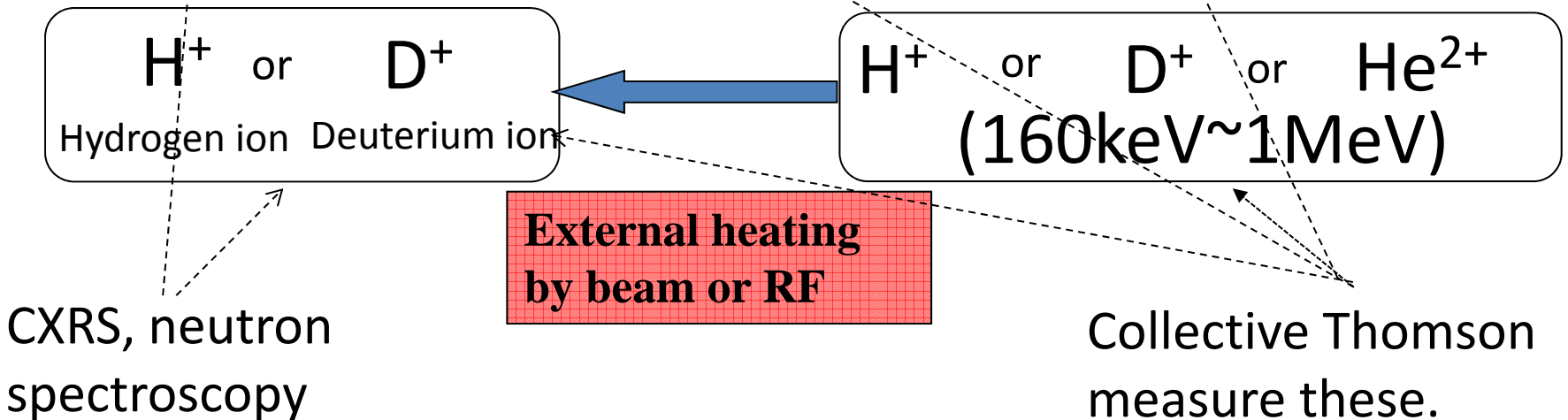

Collective condition is determined by Debye length ($\propto T_e^{1.5}/n_e^{1.5}$) and fluctuation K (\propto scattering angle)

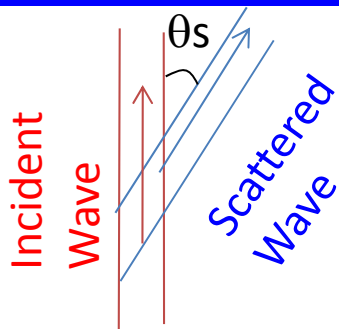

$\alpha = 1/K\lambda_d < 1$ is required for collective condition.

$\theta_s = 10\text{deg.}$

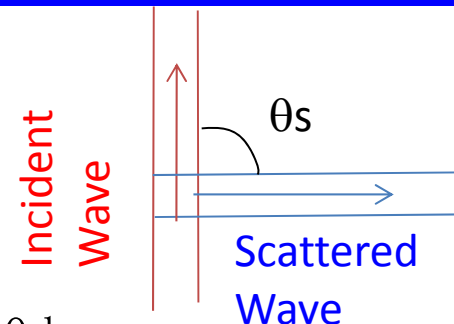

$\theta_s = 90\text{deg.}$

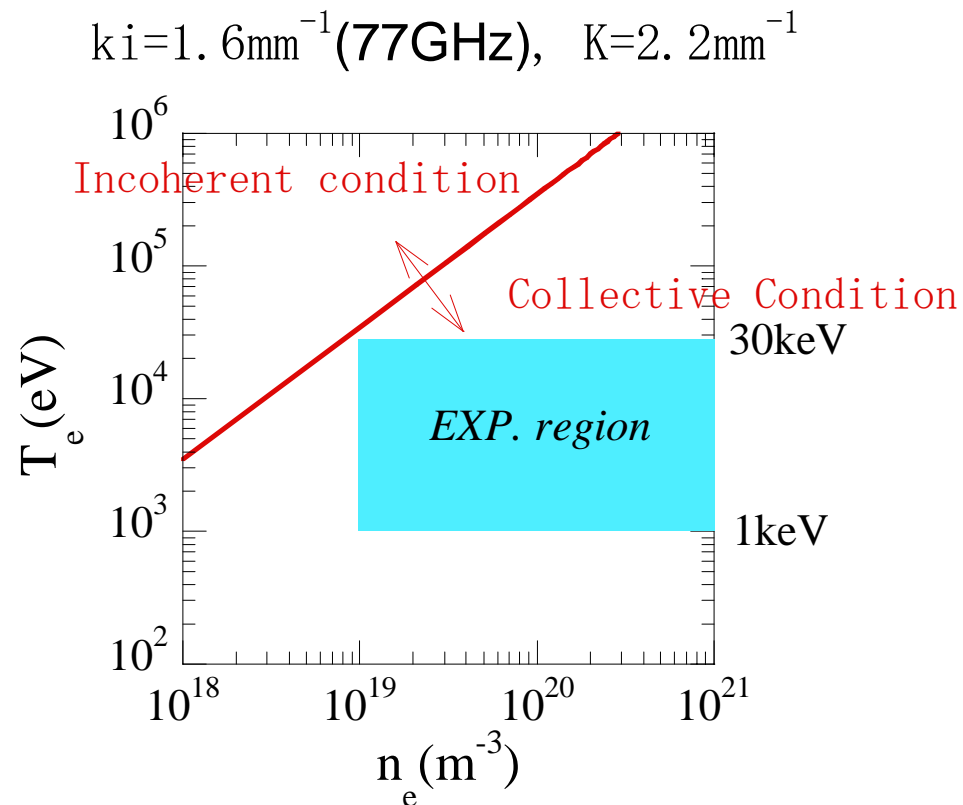
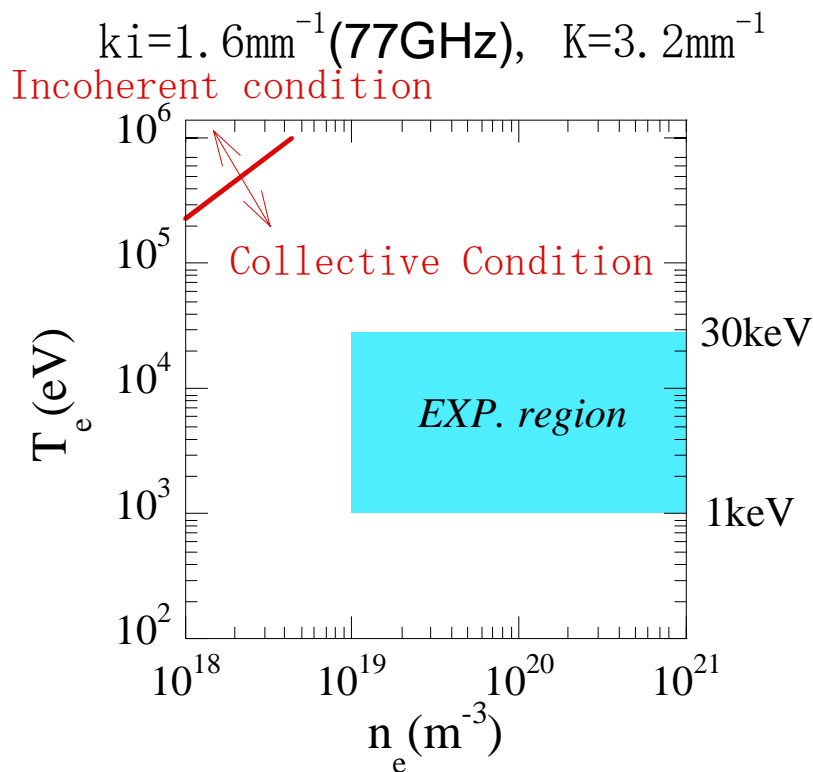

CTS spectrum tells bulk thermalized ion, electron and non thermalized fast ion.

Bulk ion, fast ion, bulk electron

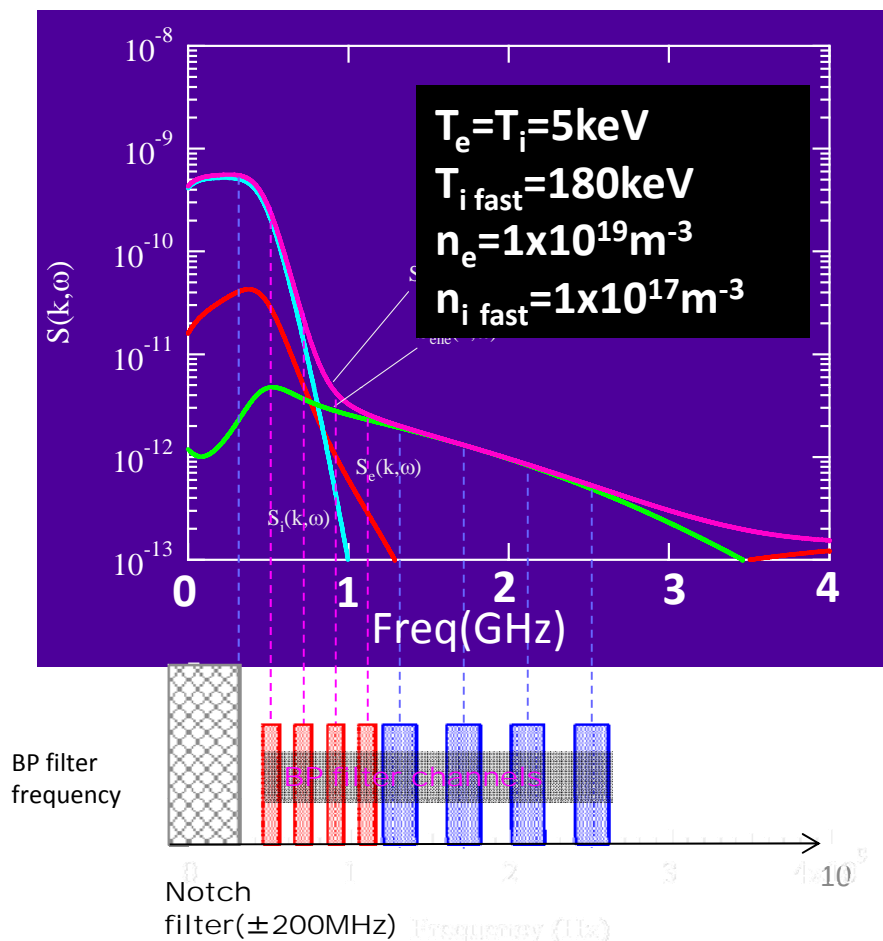

Nishiura et al.,
RSI(2008)

Electron density and temperature are available from other diagnostic (incoherent Thomson, interferometer), thus ion information is determined as free parameters

Spectrum can be measured either filter bank system or fast digitizer.

The difficulty of CTS for high temperature plasma

- 1) Microwave high power gyrotron is probably only solution to get reasonable spatial resolution and signal intensity.
- 2) Even using high power microwave ($\sim 100\text{kW}$), scattered power is order of nW.
- 3) Small noise can easily hide the real signal.
- 4) Good band reject filter to remove stray radiation is essential.
- 5) Fighting against ECE noise is pretty tough.

In present tokamak, frequency between fundamental and 2nd harmonics EC is selected in order to reduce ECE background noise

Tokamak Flux surface

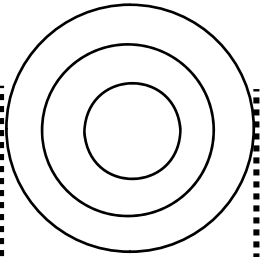

Max freq of n th EC freq. < source freq. < Min of n+1th EC freq.

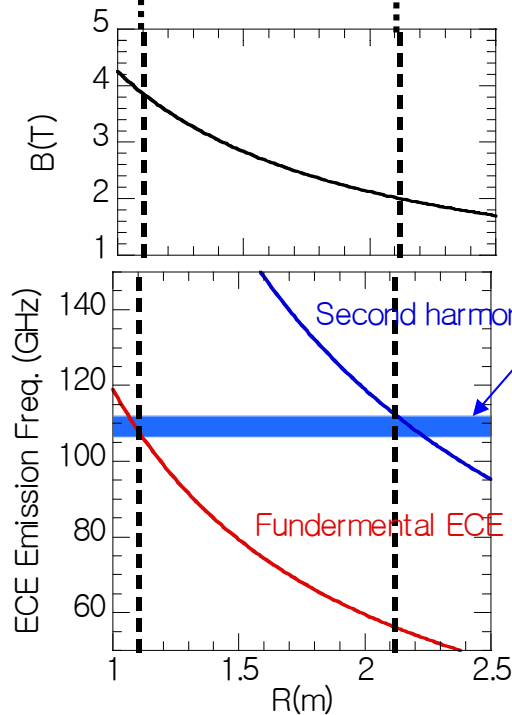

Freq. window between 1st and 2nd resonance

$$28n B_{\max} < f(\text{GHz}) < 28(n+1) B_{\text{mir}}$$

$$\frac{B_{\max}}{B_{\text{min}}} < \frac{n+1}{n}$$

In LHD, B_t cannot be tuned to expel resonance

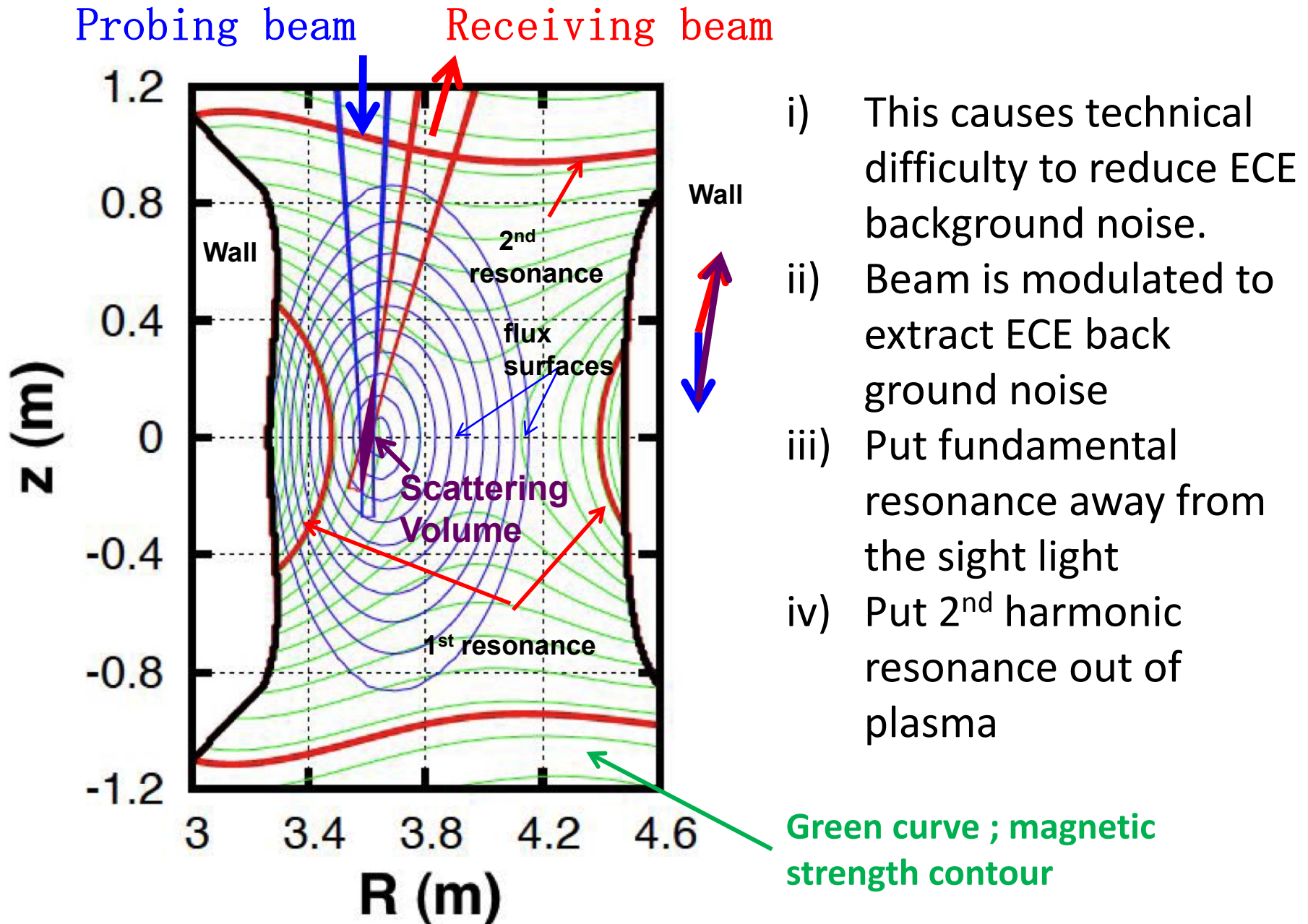

LHD CTS system

Heterodyne Receiver for Collective Thomson Scattering in LHD

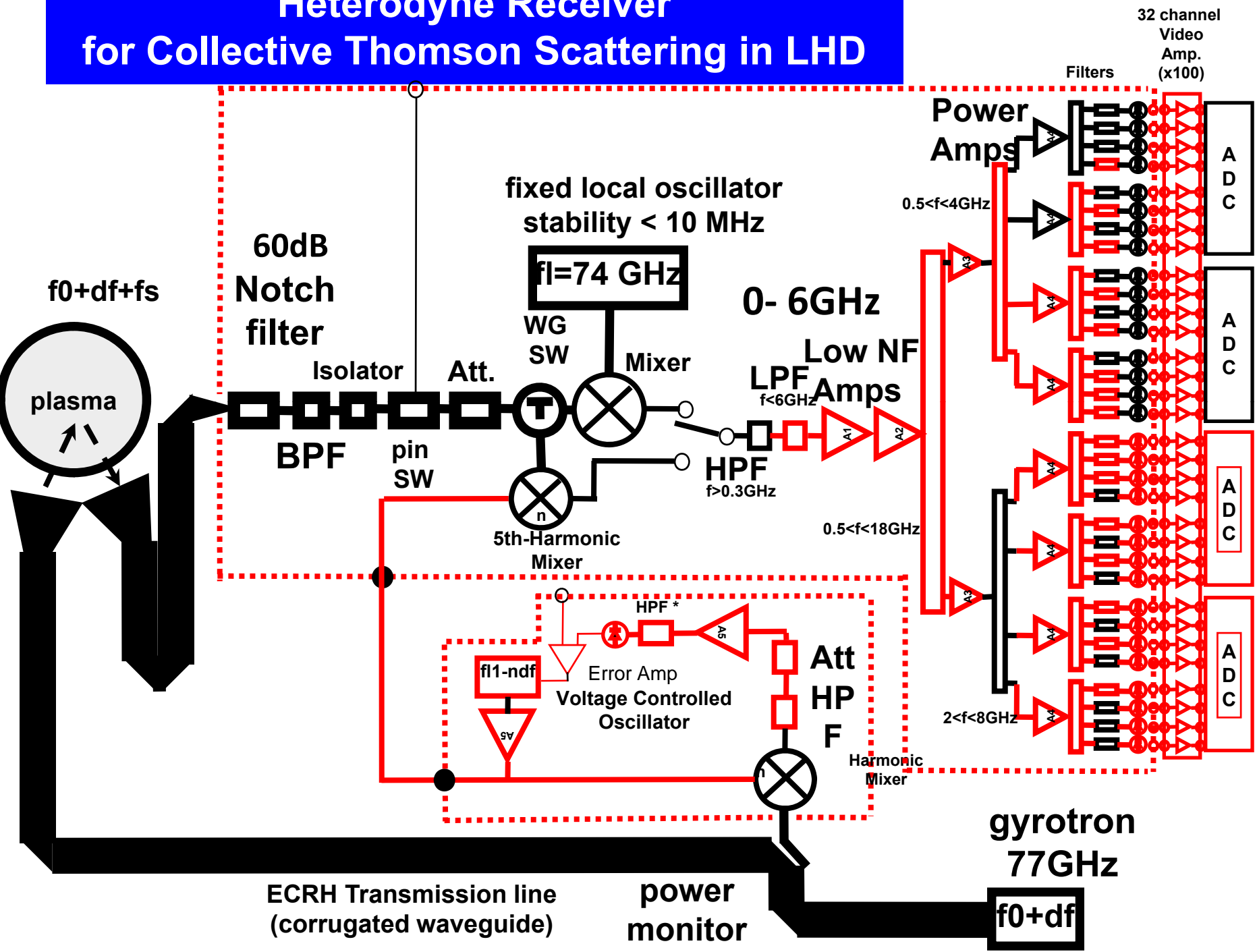

Spectrum is measured by filter bank system. Stray radiation around gyrotron frequency (76.95GHz) \pm 100MHz is cut by Notch filter (-120dB)

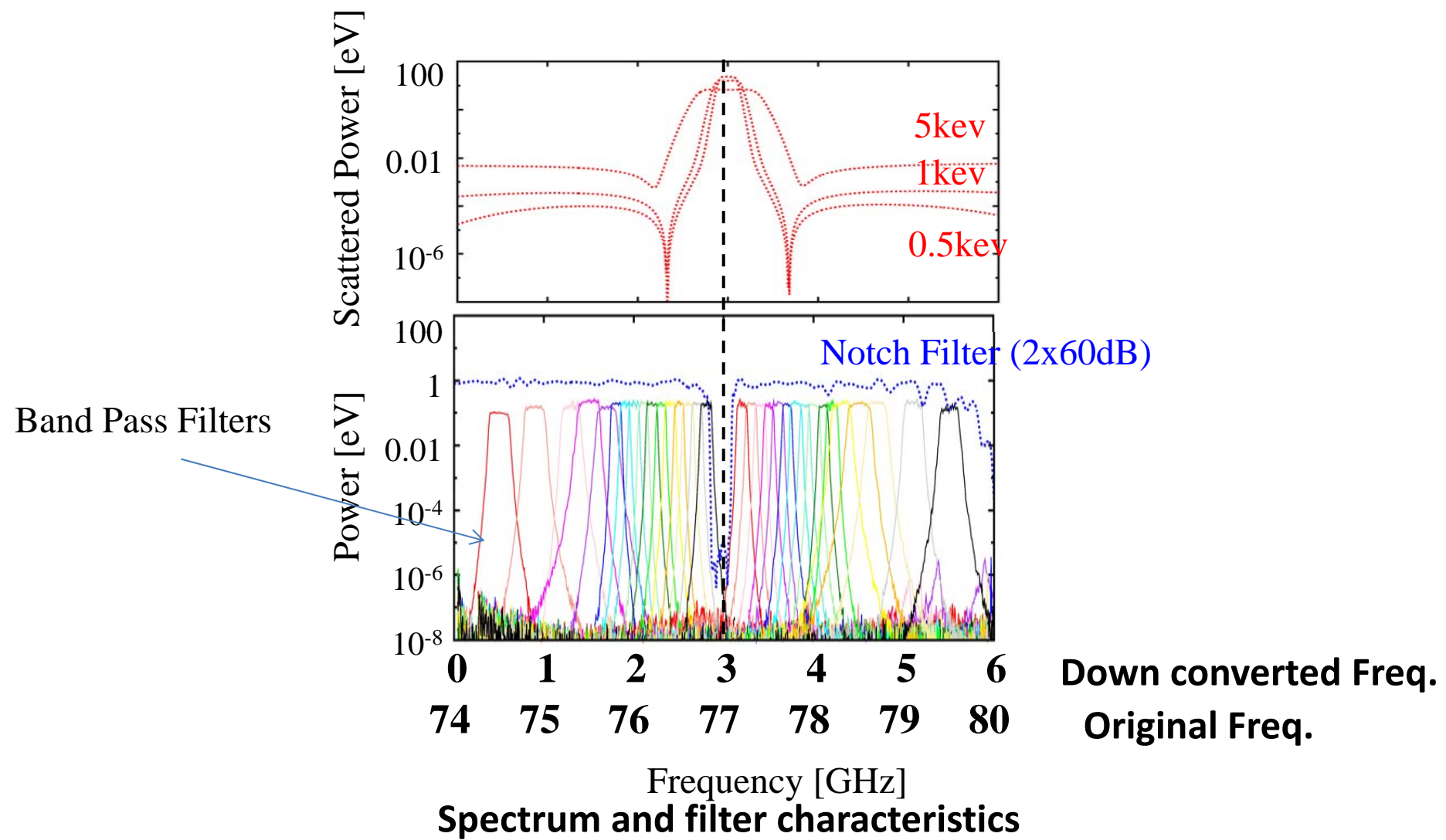

Calibration and keeping linearity are necessary.

Three versions of scattering geometry were tried in order to measure different fast ion velocity components

Red; Probe beam
Blue; receiving beam

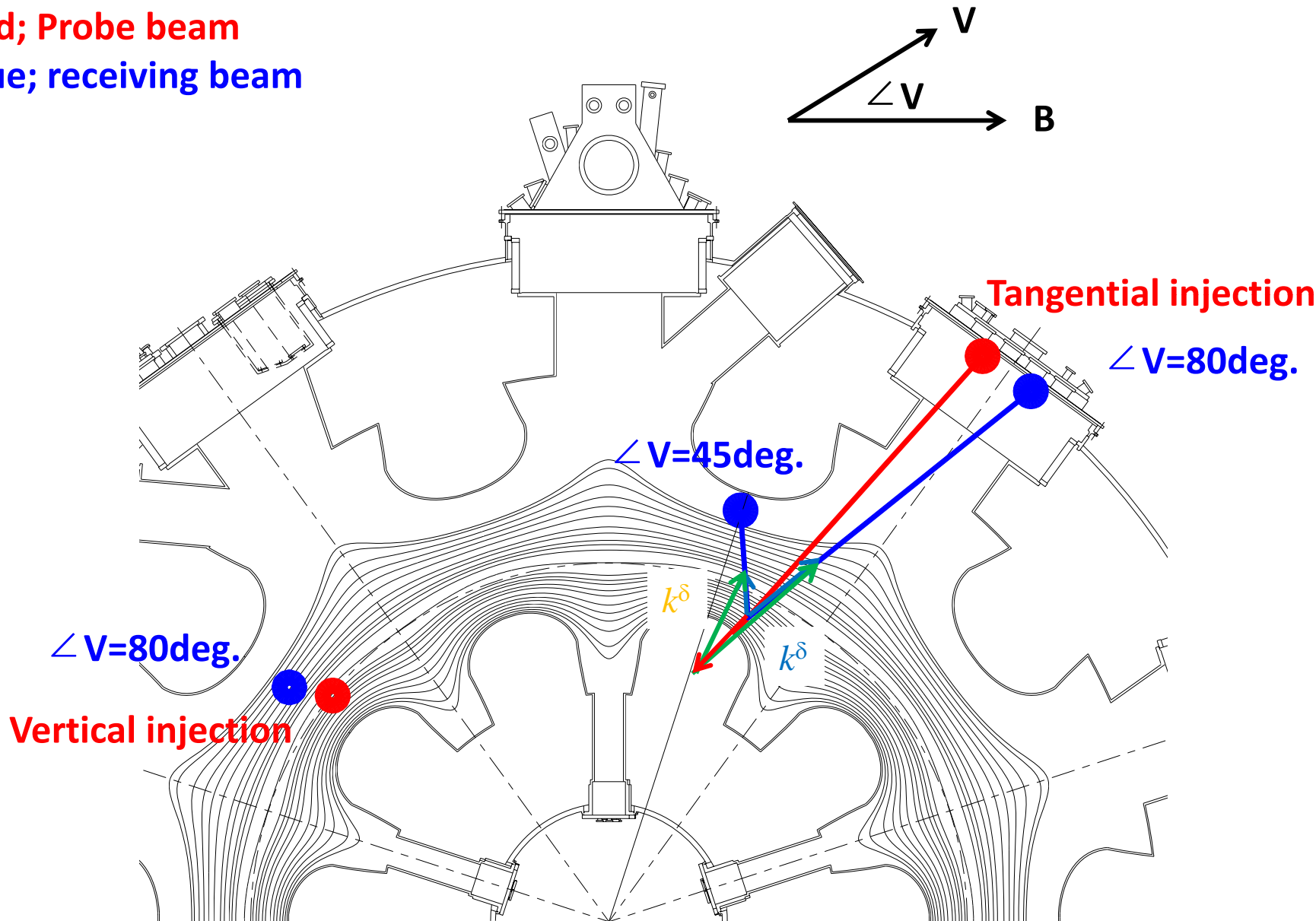

Change of geometry

2008~2010

from Waveguides

Top port

Probing beam

Receiving Beam

Focusing Mirror

Steering Mirror

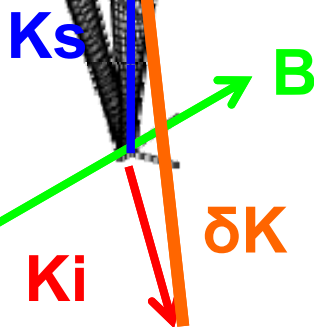

K_{perp} is dominated.

2011~

Horizontal port

Probing beam

Receiving Beam

Bottom port

K_{para} contribution
lager

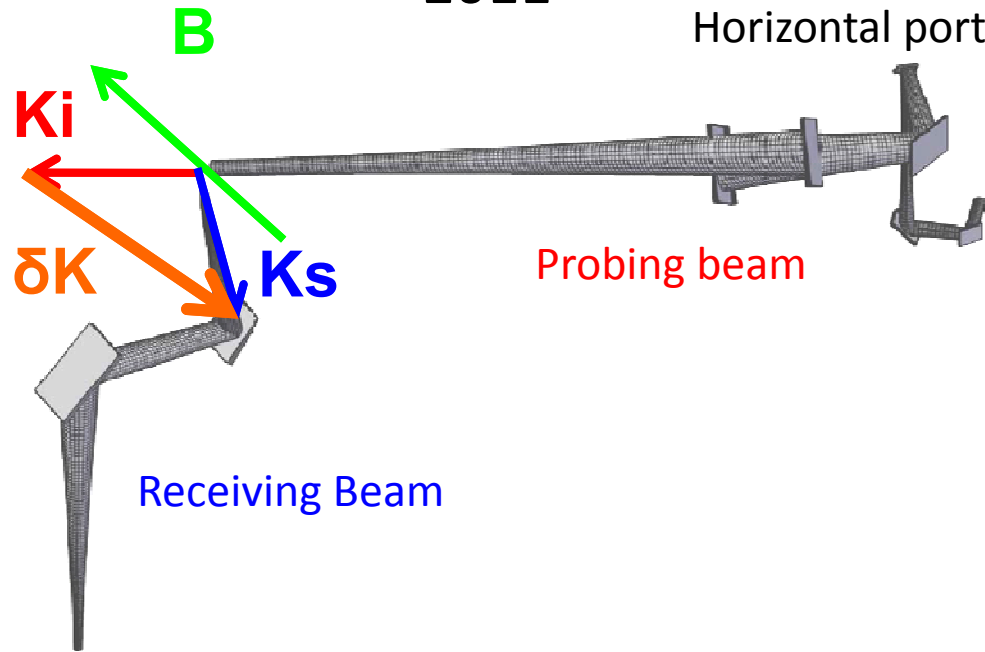

Experimental results

Raw signals of CTS. Gyrotron was modulated in order to extract ECE background noise

LHD CTS #91758

On timing ; Signal +ECE, Off timing ; ECE

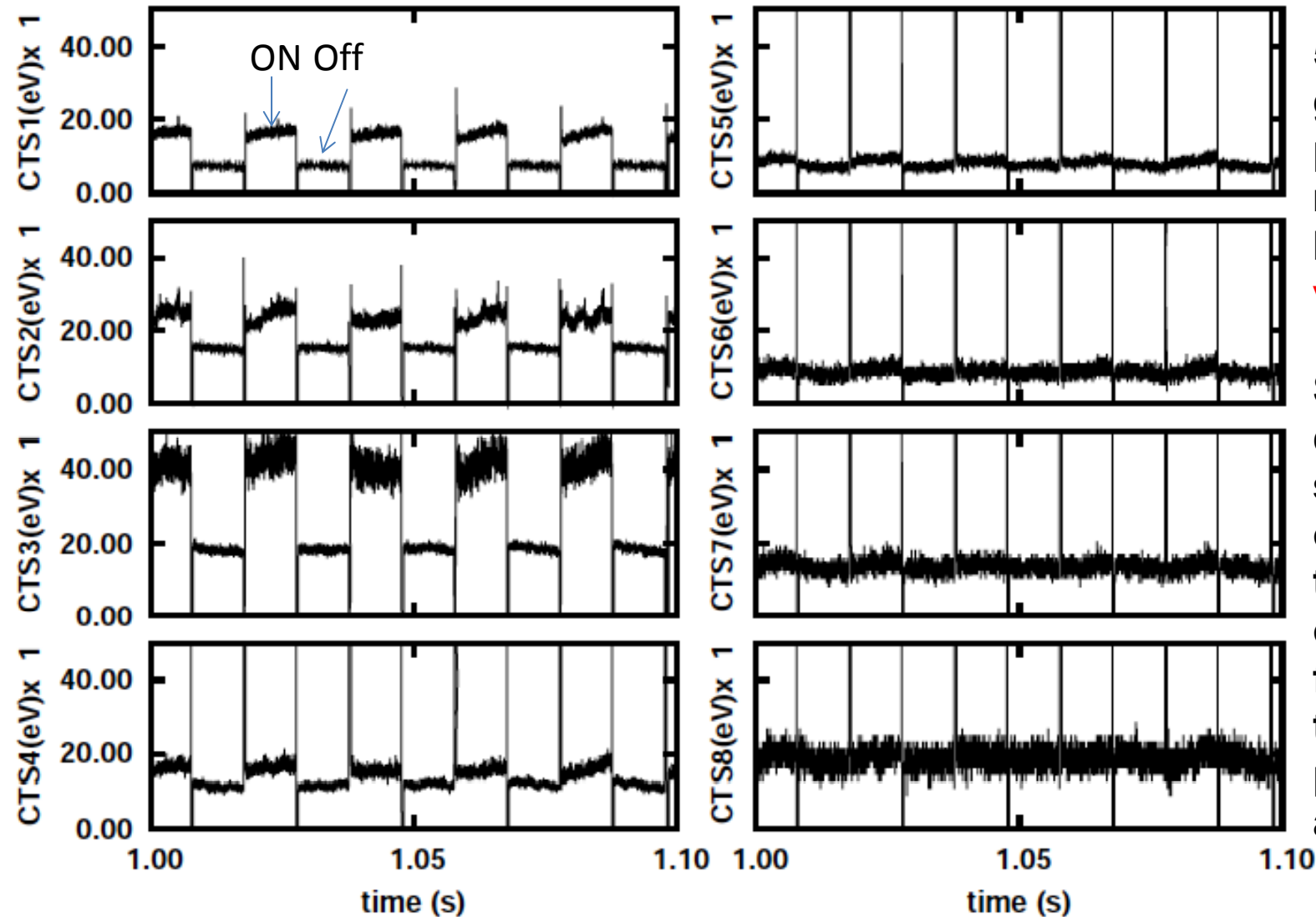

50 Hz gyrotron power modulation by **anode voltage**

Spikes are due to the spurious oscillation of the gyrotron out of notch frequency at transient phase of anode voltage

Spikes are removed numerically and separated on/off phase

LHD CTS #91758

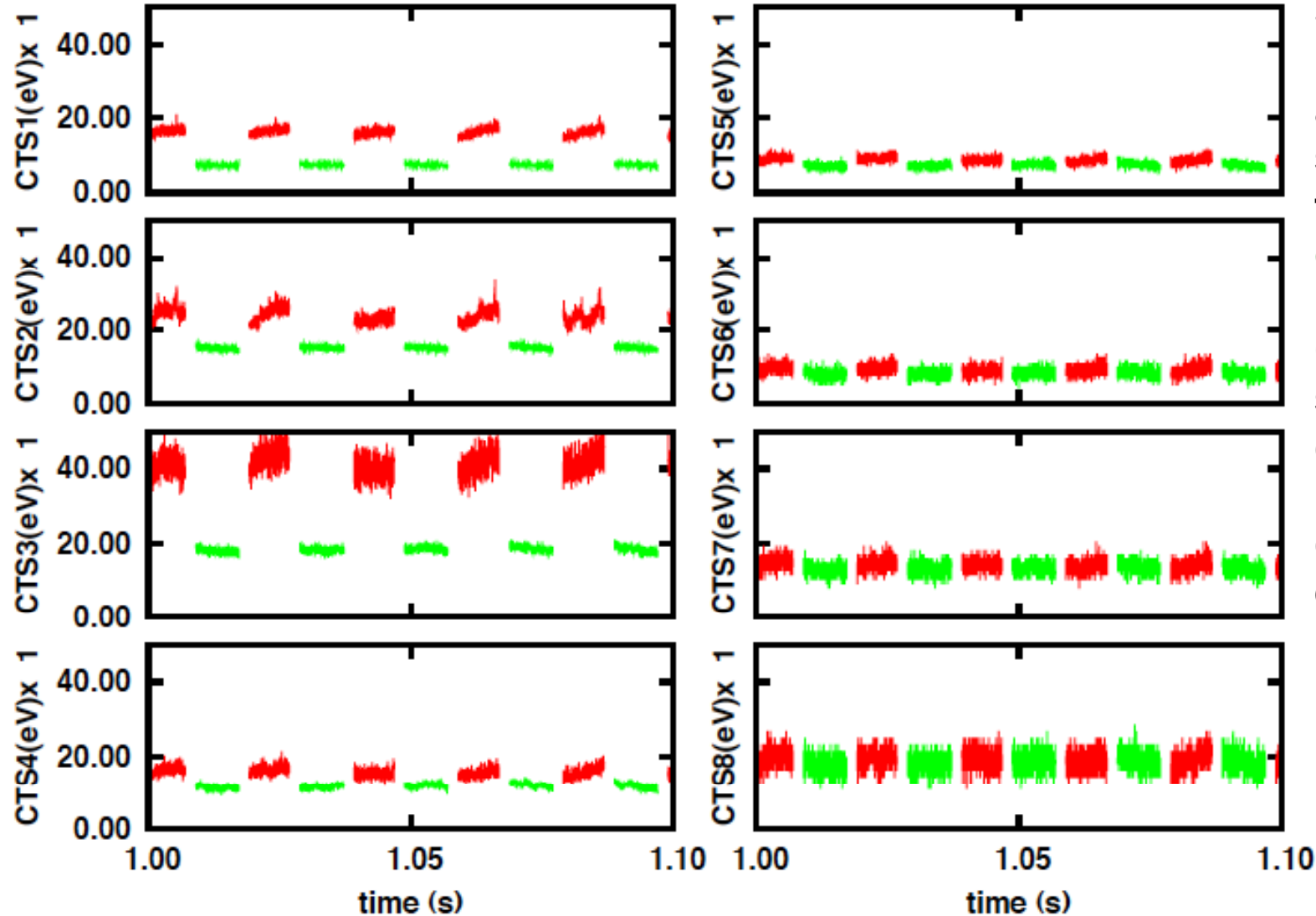

Spikes are removed and separated to **on** and **off** phase.

Changes in slope are due to heating and diffusion effect of the background ECE.

Spectrum shape was fitted with bulk temperature

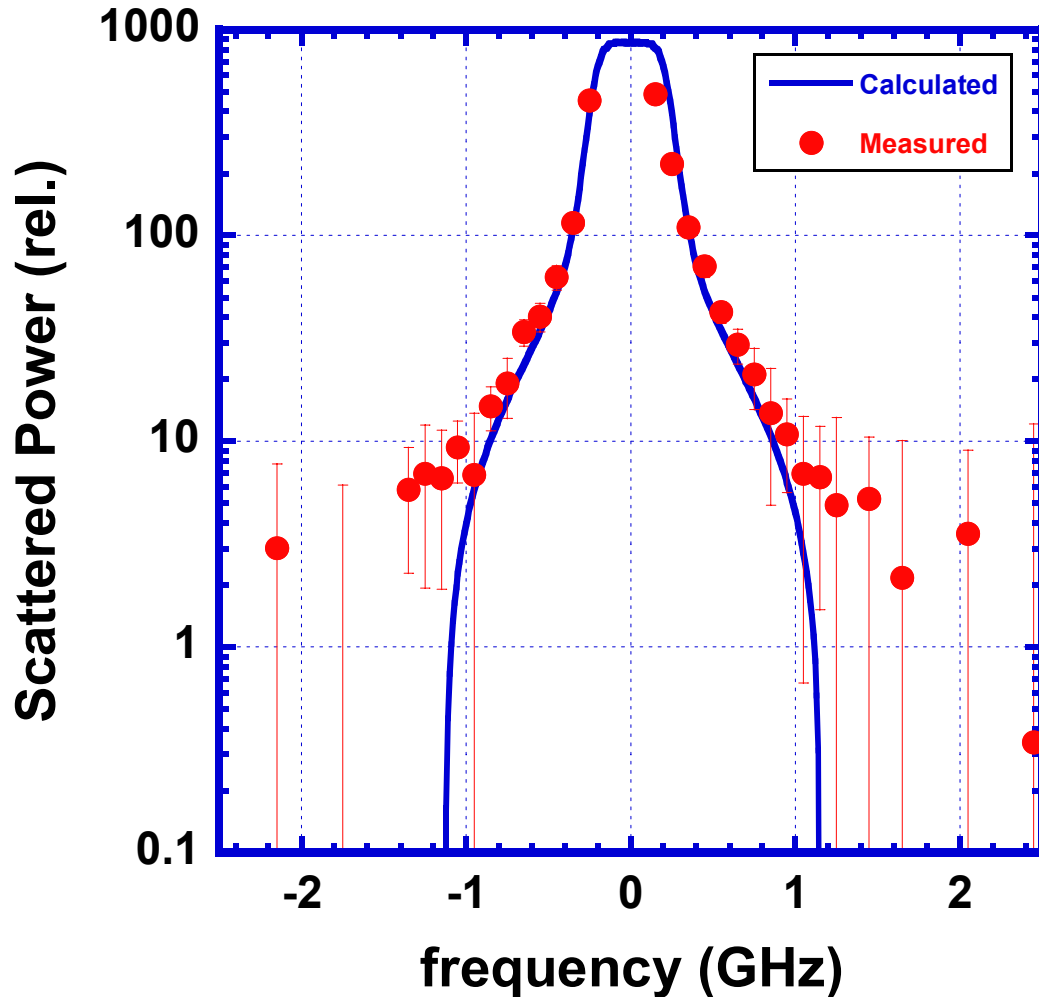

Spectrum is not absolutely calibrated.

Measured data are used for calculation.

$T_e = 0.8 \text{ keV}$
(from YAG TS)

$T_j = 0.7 \text{ keV}$
(from Ar broadening)

$n_e = 2.5 \times 10^{19} \text{ m}^{-3}$
(from FIR interferometer)

$N_{\text{fast } 40 \text{ keV}} = 0.25 \times 10^{19} \text{ m}^{-3}$
(Fitted) \rightarrow 10% of bulk density too high?

Sensitivity of fitting with calibrated data

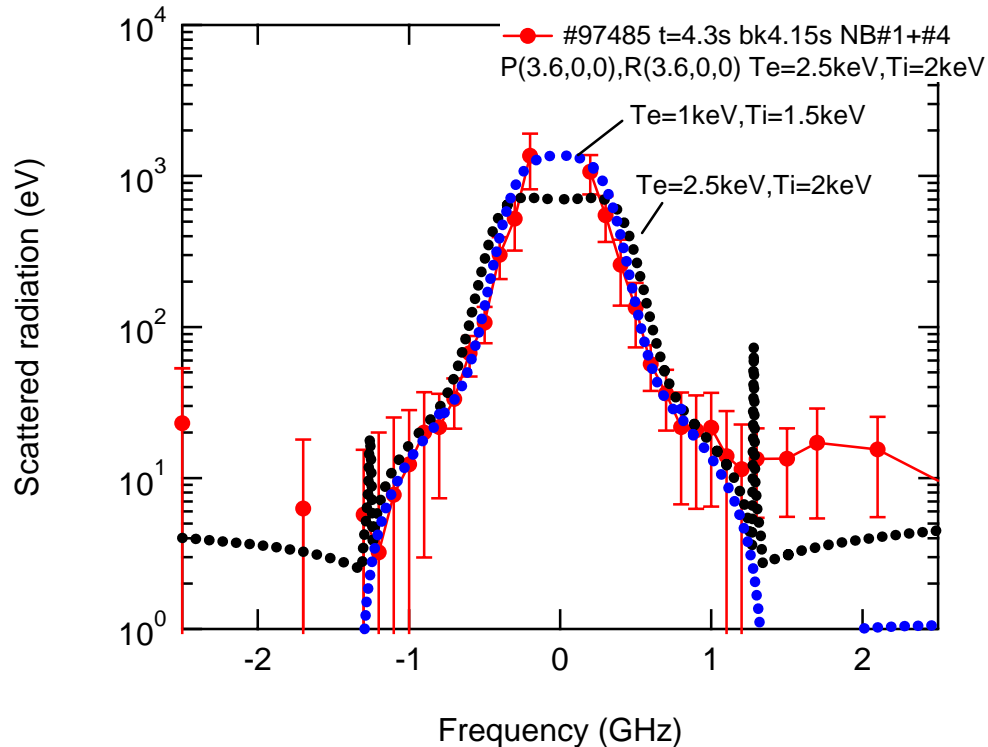

**Black (Exp. Data from
YAG TS and CXRS);
Te=2.5keV, Ti=2keV**

**Blue (other candidate of
parameter); Te=1keV,
Ti=1.5keV**

Blue is more likely to fit experimental data than black, but blue is unlike parameter compared with YAG TS and CXRS.

Increase of bulk channel and check of the calibration data is necessary. Especially, numerical FFT by using fast digitizer will help

Signature of fast ion components

#3, para, #4 perp.

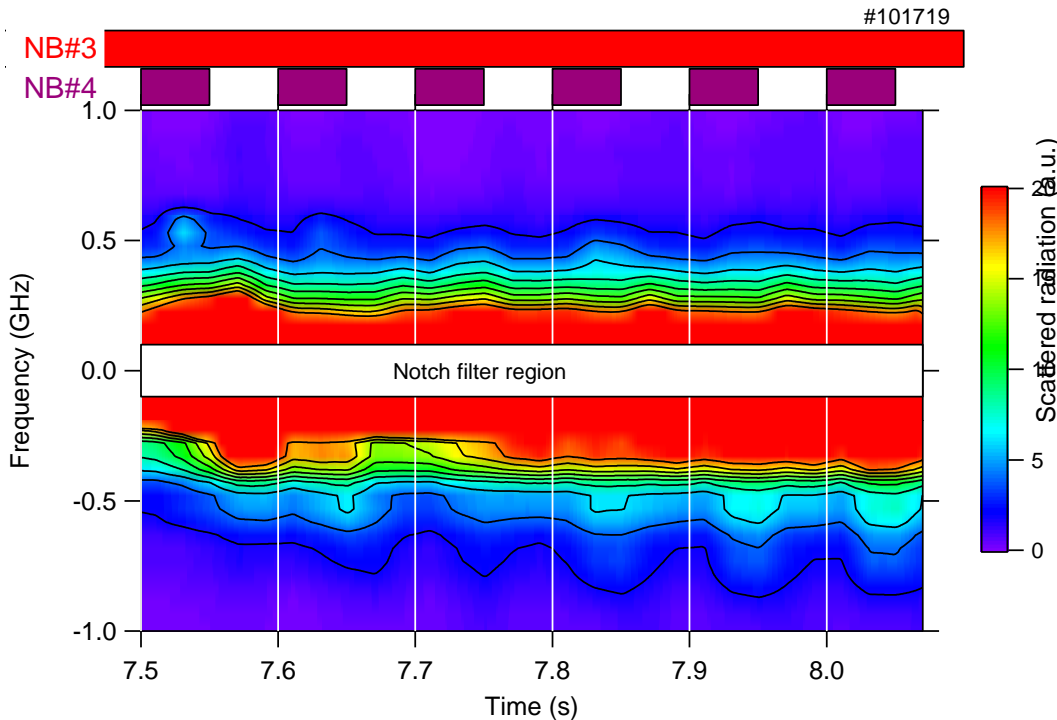

Scattering geometry is sensitive to perp. components

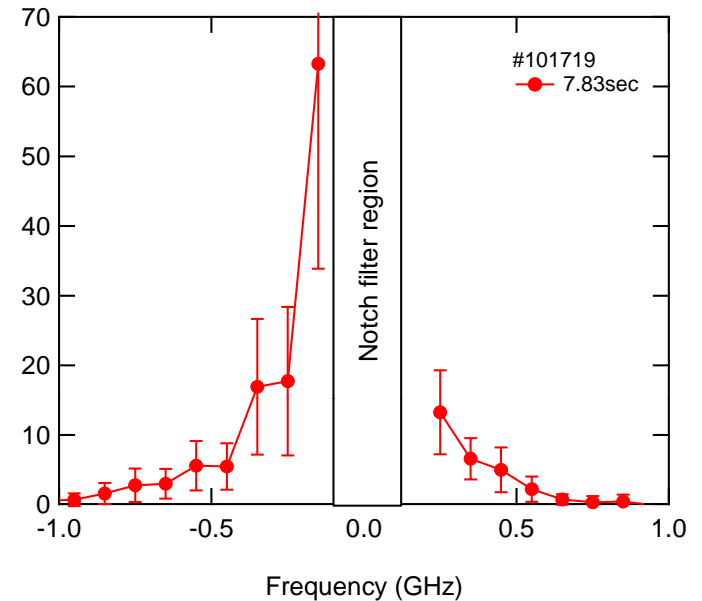

When perpendicular NBI is injected, components higher than 0.5GHz are observed. This is likely to be fast ion components.

Signal is weak. Asymmetry of spectrum is unlikely for perpendicular beam. → This might be caused by the drift of gyrotron frequency.

In campaign of 2011 ,in order to improve the signal quality, we tried

i) checking of gyrotron frequency and fine spectrum measurements using a fast digitizer

ii) Scan of scattering volume using fast sweeping mirror system to confirm scattering position

Gyrotron frequency was measured by fast digitizer

The gyrotron output is introduced into the CTS receiver .

The nominal frequency is 76.95GHz. The actual frequency depends on the gyrotron operation.

The frequency shift is about 20MHz at 80 ms pulse. The shift comes from the thermal expansion of the gyrotron cavity.

➡ The gyrotron frequency exists inside the notch filter.

The time constant for the above shift is about 30~40ms.

➡ The CTS probing beam is modulated with the frequency of 50Hz. The frequency shift has to be taken care of for CTS analysis.

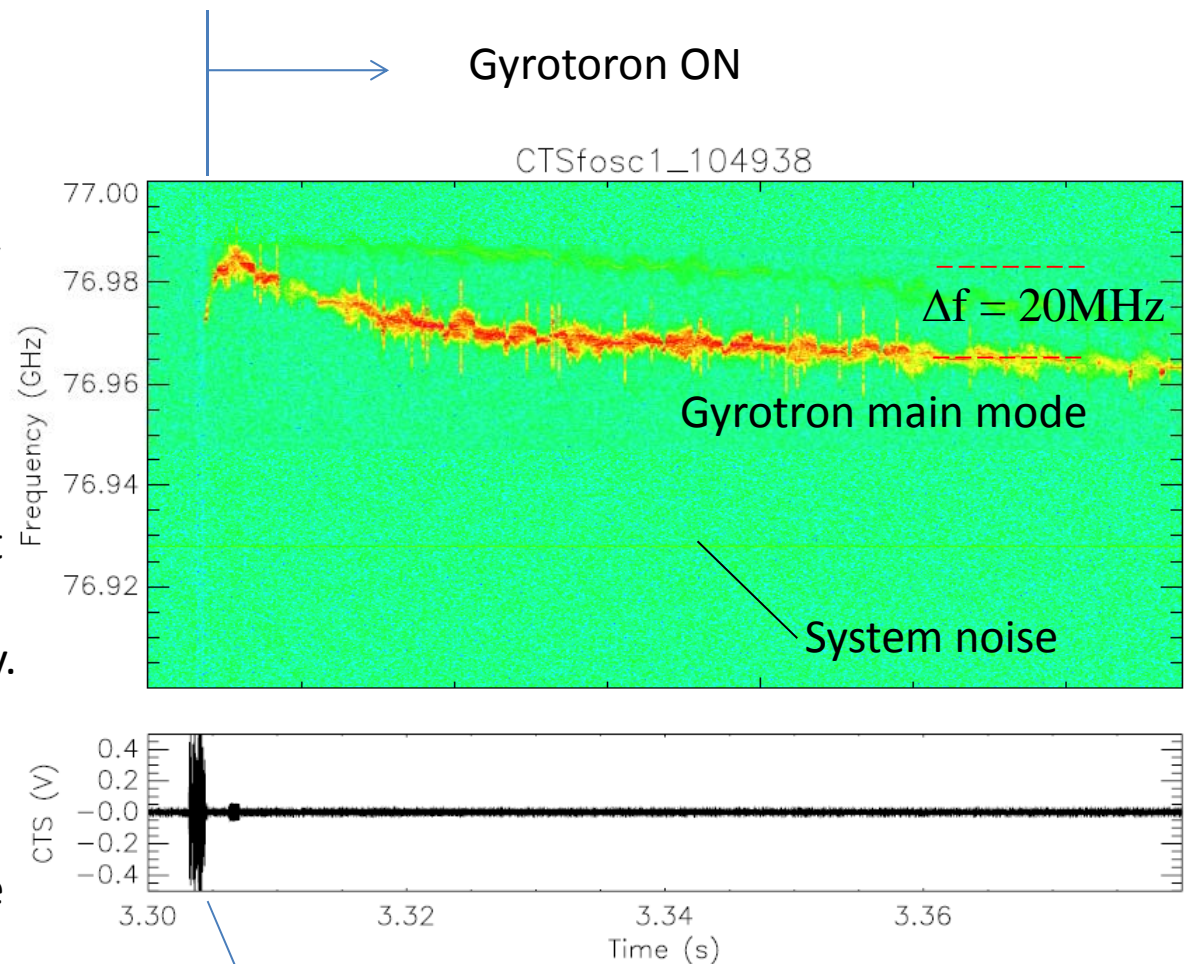

Frequency shifts may cause the asymmetry of spectrum.

Spuripus mode was observed. This distorts spectrum.

At the gyrotron output ON timing and OFF timing, the spurious mode appeared. This mode should be removed for CTS measurement.

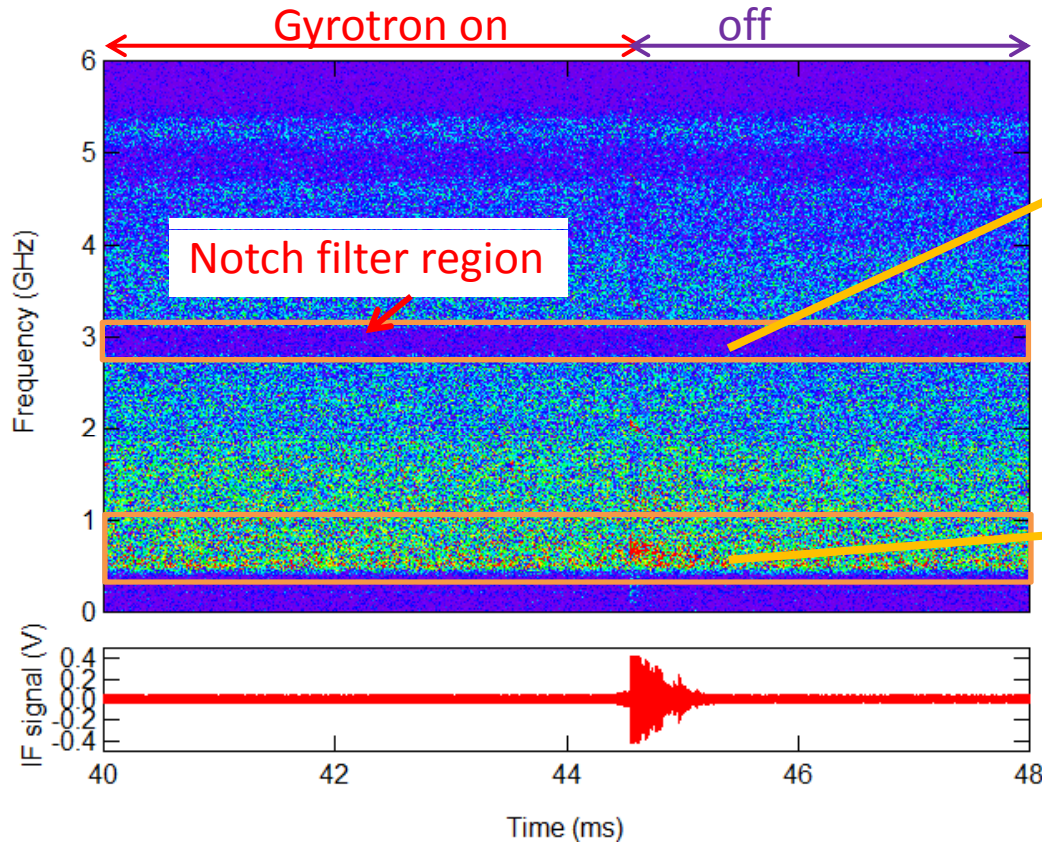

The time and frequency domain signal is measured by CTS receiver at LHD#101711. L#1,L#2,L#7, all 77GHz gyrotron IF frequency = 0~6GHz

Probing beam L#7
Nominal frequency is 76.95GHz

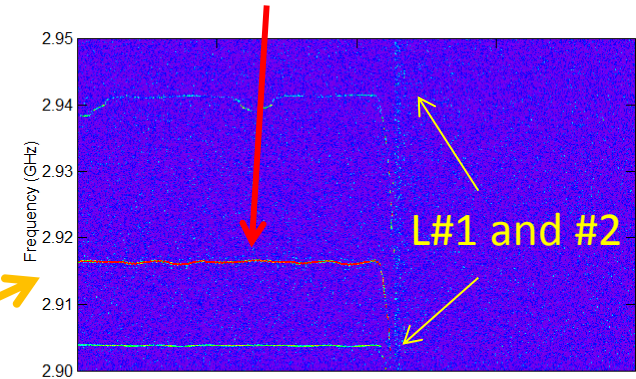

Inside the notch filter

Spurious lines at the trailing edge
~74.6GHz

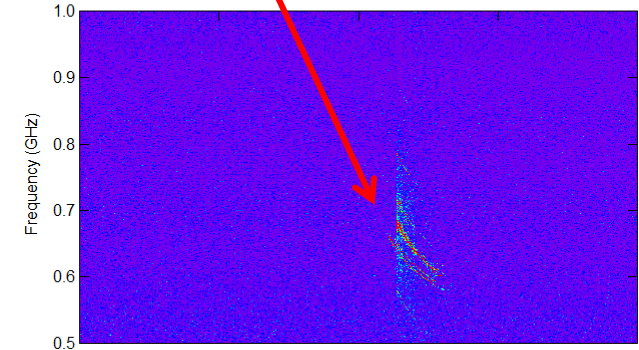

Outside the notch filter

Fine spectrum was measured by fast digitizer

Fast digitizer

**National Instruments,
NI-PXIe 5186**

BW: 5 GHz

Sampling rate: 12.5 GS/s

Resolution: 8-Bit

**Memory: 1GB (80ms
duration)**

**The 77GHz range signal is
down converted to the IF
signal from 0 to 6GHz,
which is directly calculated
and transformed by FFT.**

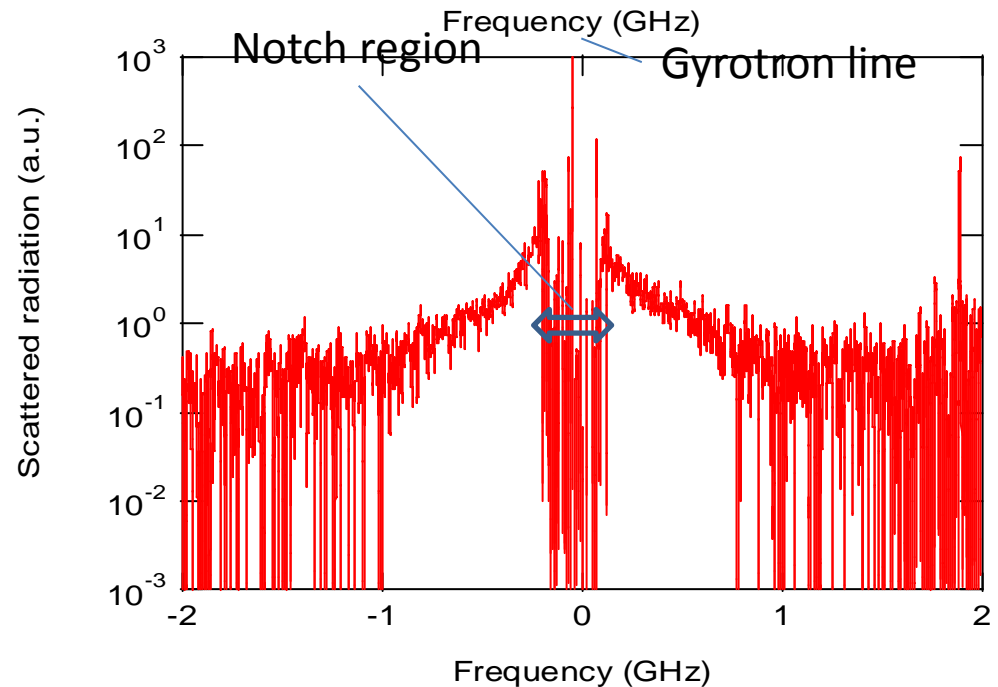
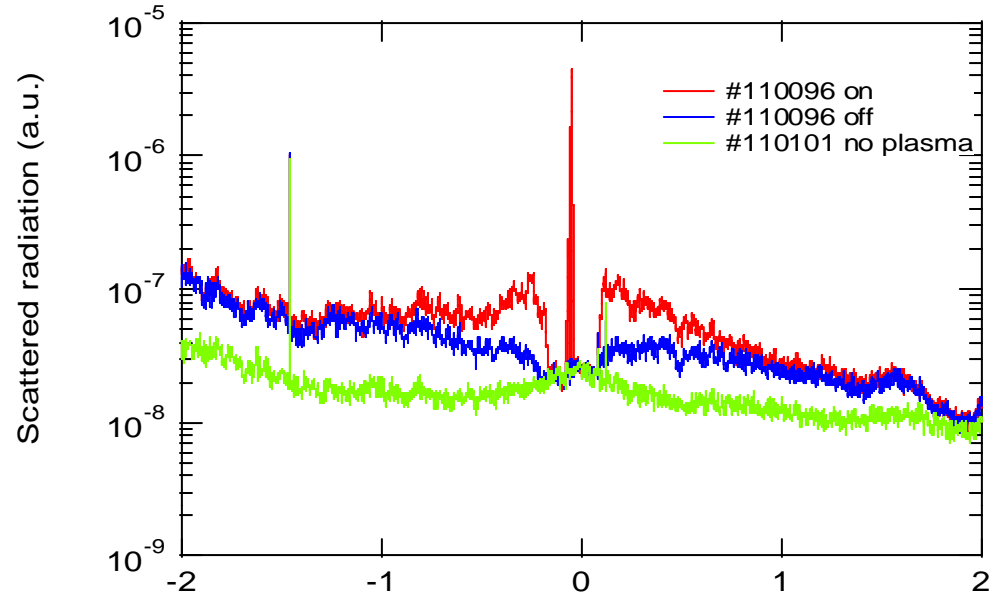

Fast sweeping mirror system enabled to check antenna alignment.

shot109834

Preliminary

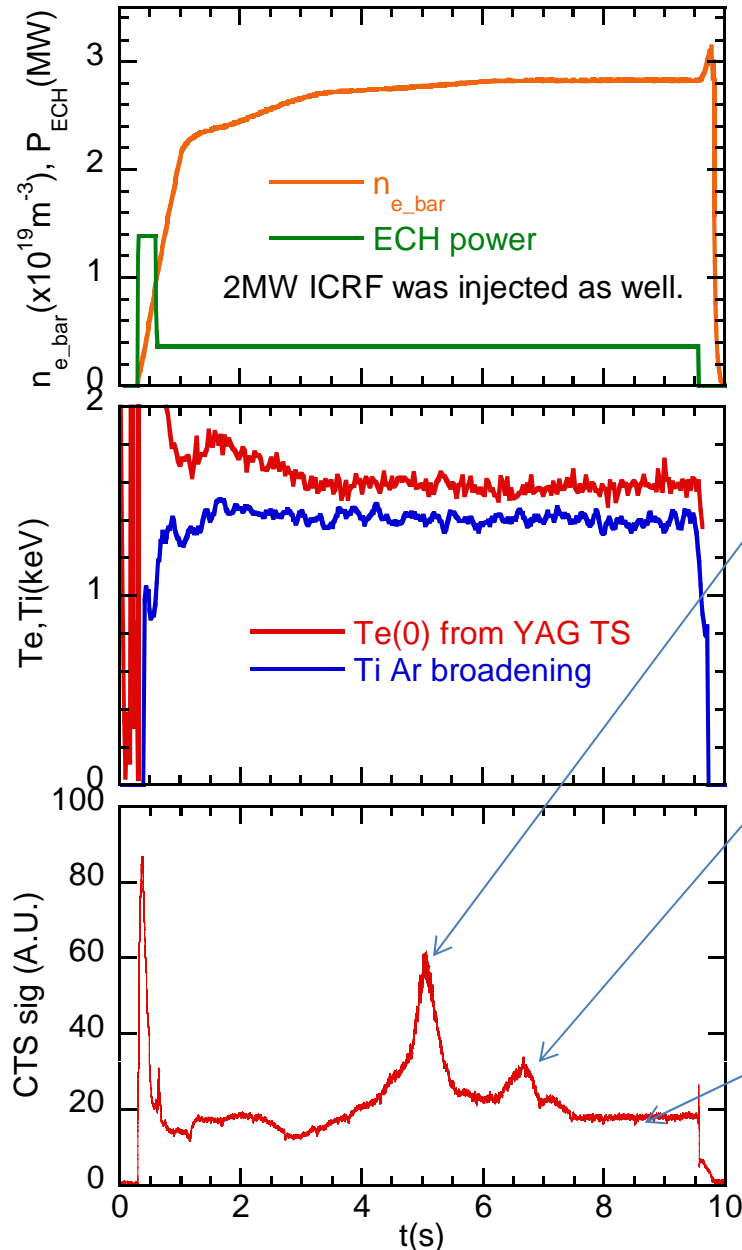

Signal becomes strongest at around maximum scattering volume. This peak is observed only in bulk channel

The second peak is observed. This may be due to stray radiation or multiple reflection.

ECE background radiation is still significant. This can be excluded ECH modulation.

Summary

1. In LHD, collective Thomson scattering system is being developed to measure bulk and fast ion density and temperature.
2. 32 ch filter bank system (bulk 16ch, fast ion 16ch) and fast digitizer system are routinely working.
3. Fast digital oscilloscope and fast digitizer enables to measure fine structure of the spectrum.
4. Bulk ion and fast ion density were estimated from the fitting of filter bank system output.
5. Fitted values were unlike values.
6. Signature of the fast ion was observed.
7. Fast sweeping mirror system was installed to check antenna alignment. Preliminary data showed maximum signal at around maximum scattering volume position.
8. Further developments are necessary, to confirm the data.

Supplement

CTS heterodyne receiver system

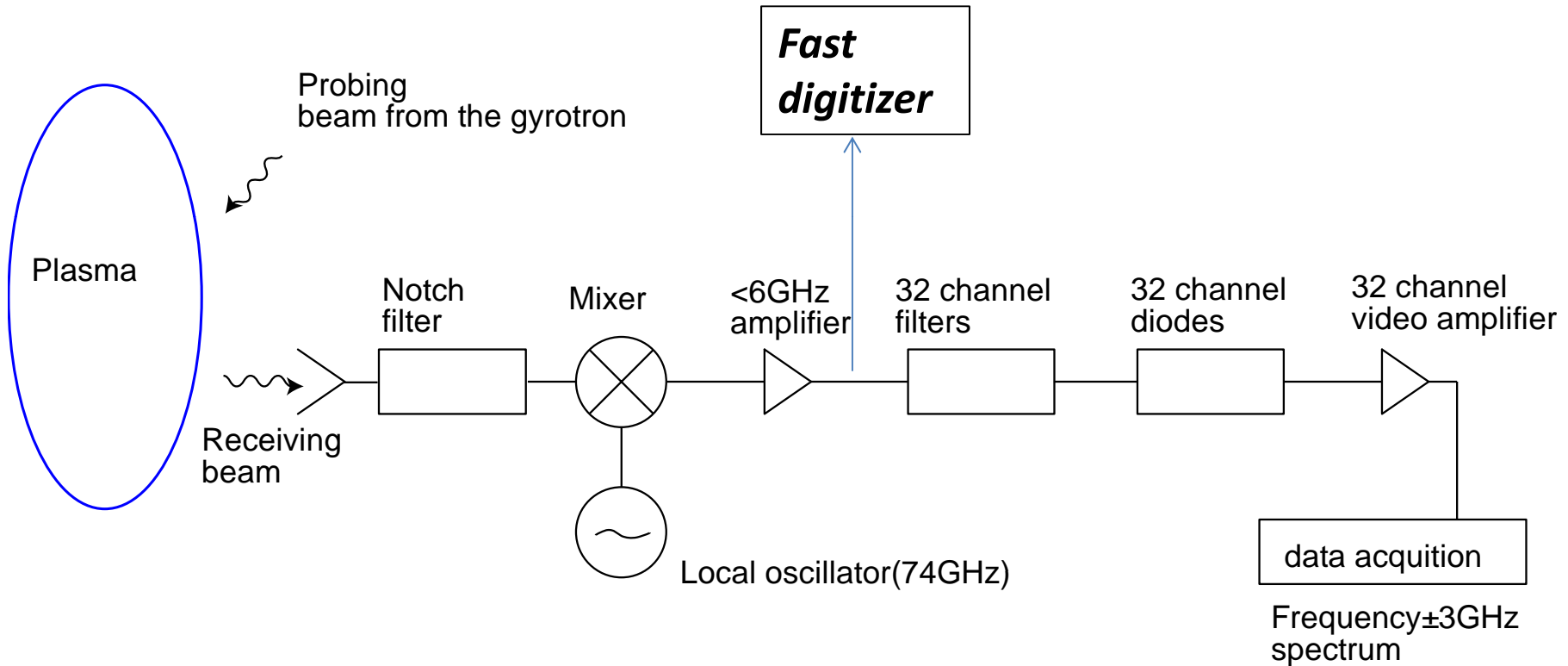

Analysis excluding heating effects

LHD CTS #91758

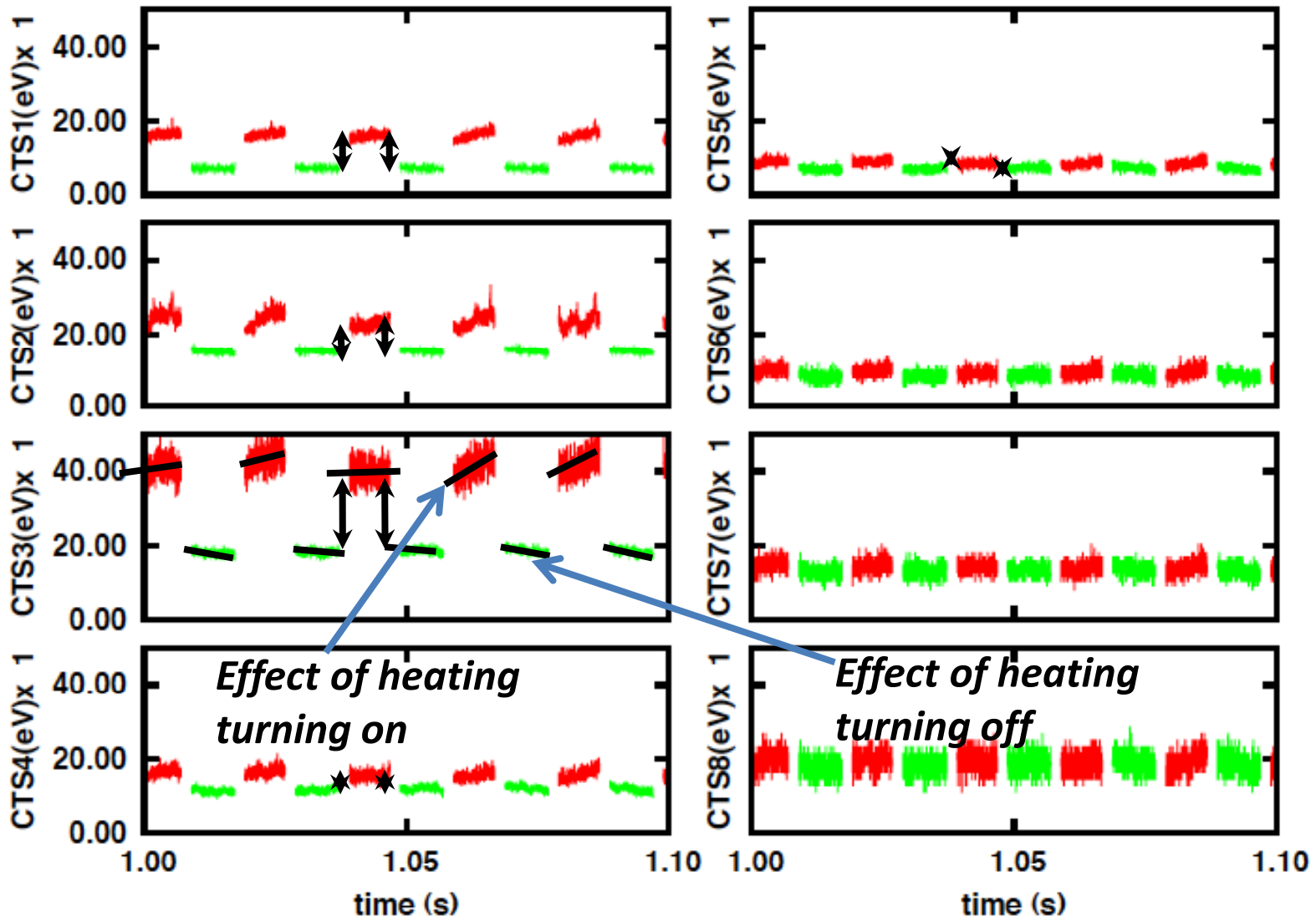

Signal of 1~2ms just after turning ON and OFF of gyrotoron was used. Step function was fitted for this time window . (Kubo et al.; 2010 RSI)

Time evolution of normalized CTS spectrum

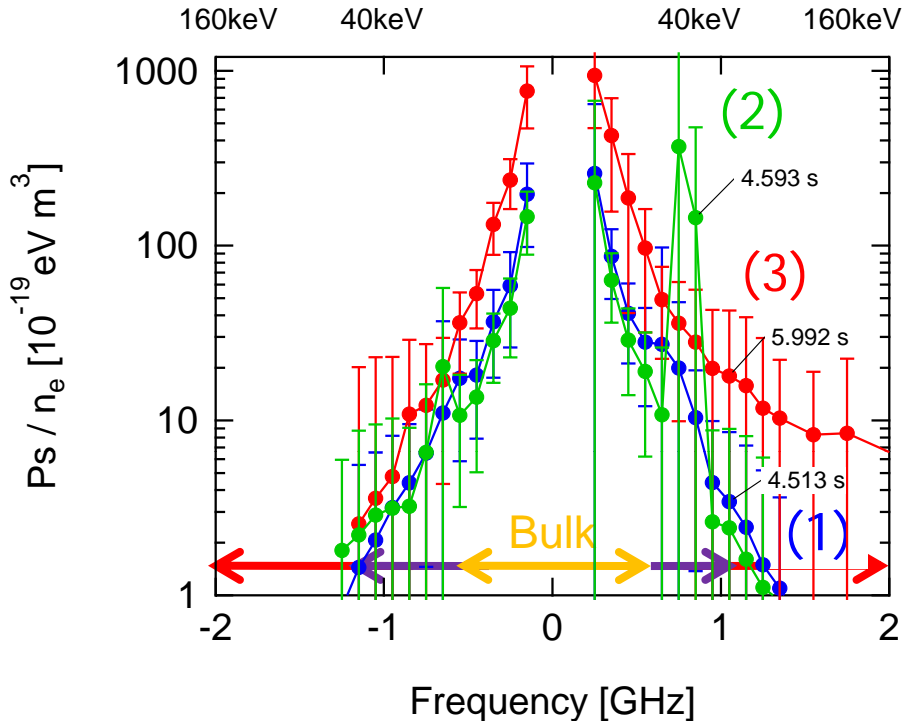
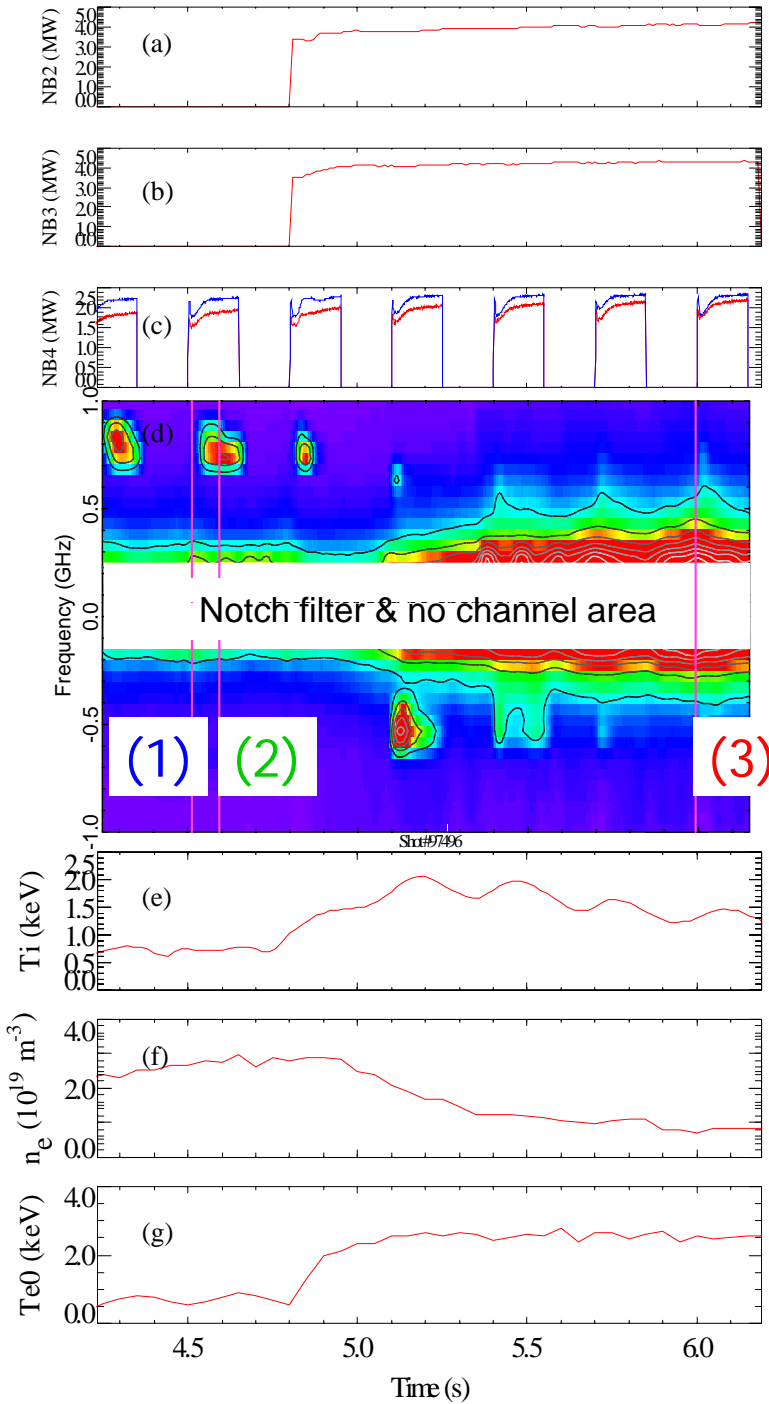

Snap shots of CTS spectrum at $t=4.513, 4.592$ and 5.93 s.

- The CTS spectrum responses to NB#4(40keV) injection

$\alpha=1/K\lambda_d < 1$ ($K\lambda_d > 1$) is required to see ion thermal motion from the scattered radiation

Small green dot; Electron

Electron shields ion charge

Large Red point; ion

Ion move toward the arrowed direction,

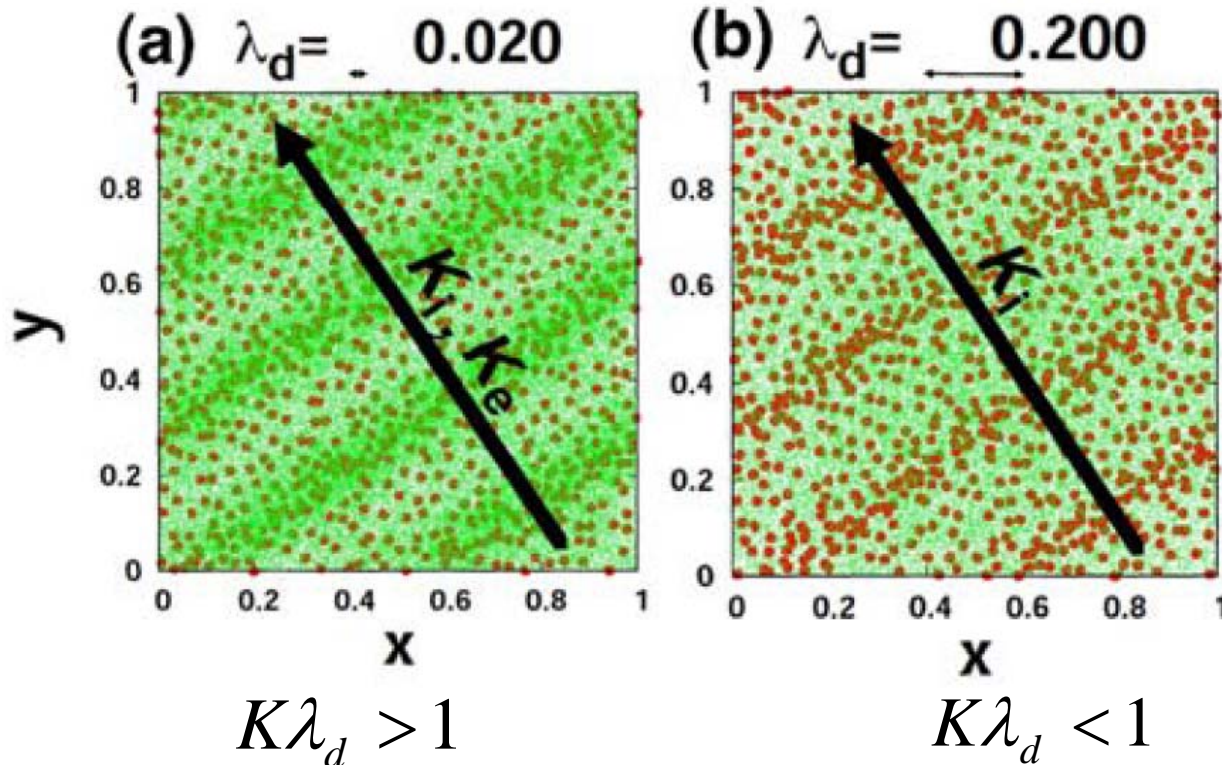

Electron follows ion movements. (Collective motion)

Electron does not follow ion movements. Moves independently (incoherent motion)

Fine spectrum measurements by using high speed sampling digital oscilloscope (6GHzBW Tectronics) and digitizer (NI). (Collaboration with Fukui Univ. and RISO.)

- Although data length and resolution is limited (5ms for oscilloscope , 50ms for digitizer, bith 8bit), fine structure of spectrum of bulk components can be measured.
- Especially, this is powerful to monitor shift of gyrotron frequency and parasitic oscillation.

Spurious mode?

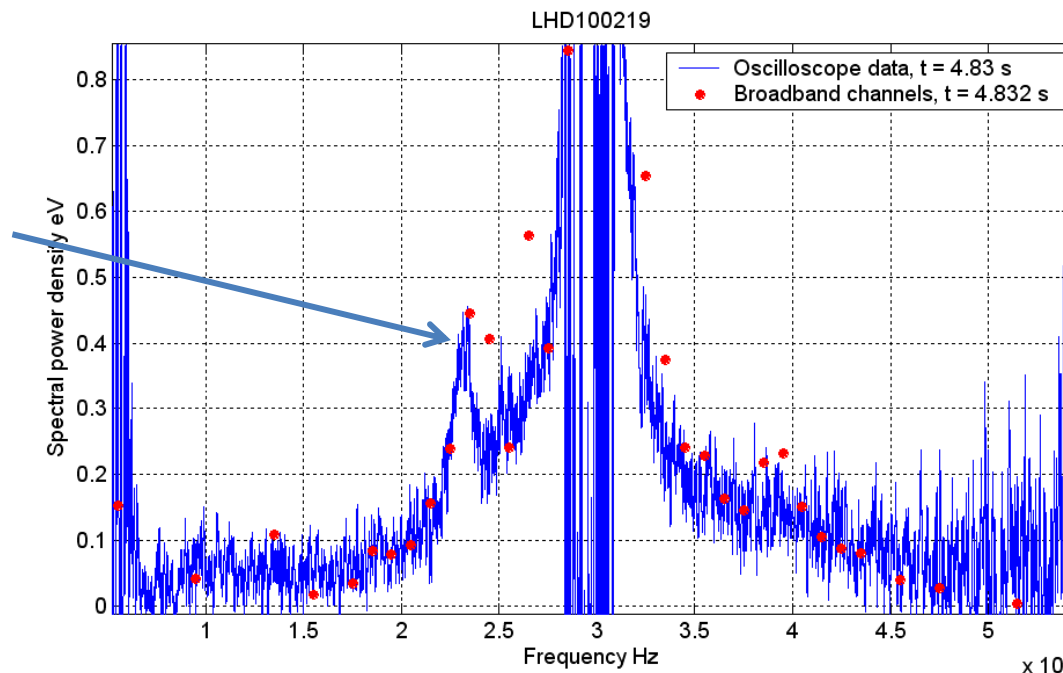

Comparison of CTS spectrum from digital oscilloscope (blue line) and filter bank output (red point)

Measured Scattering Configuration

Probing beam Receiving beam

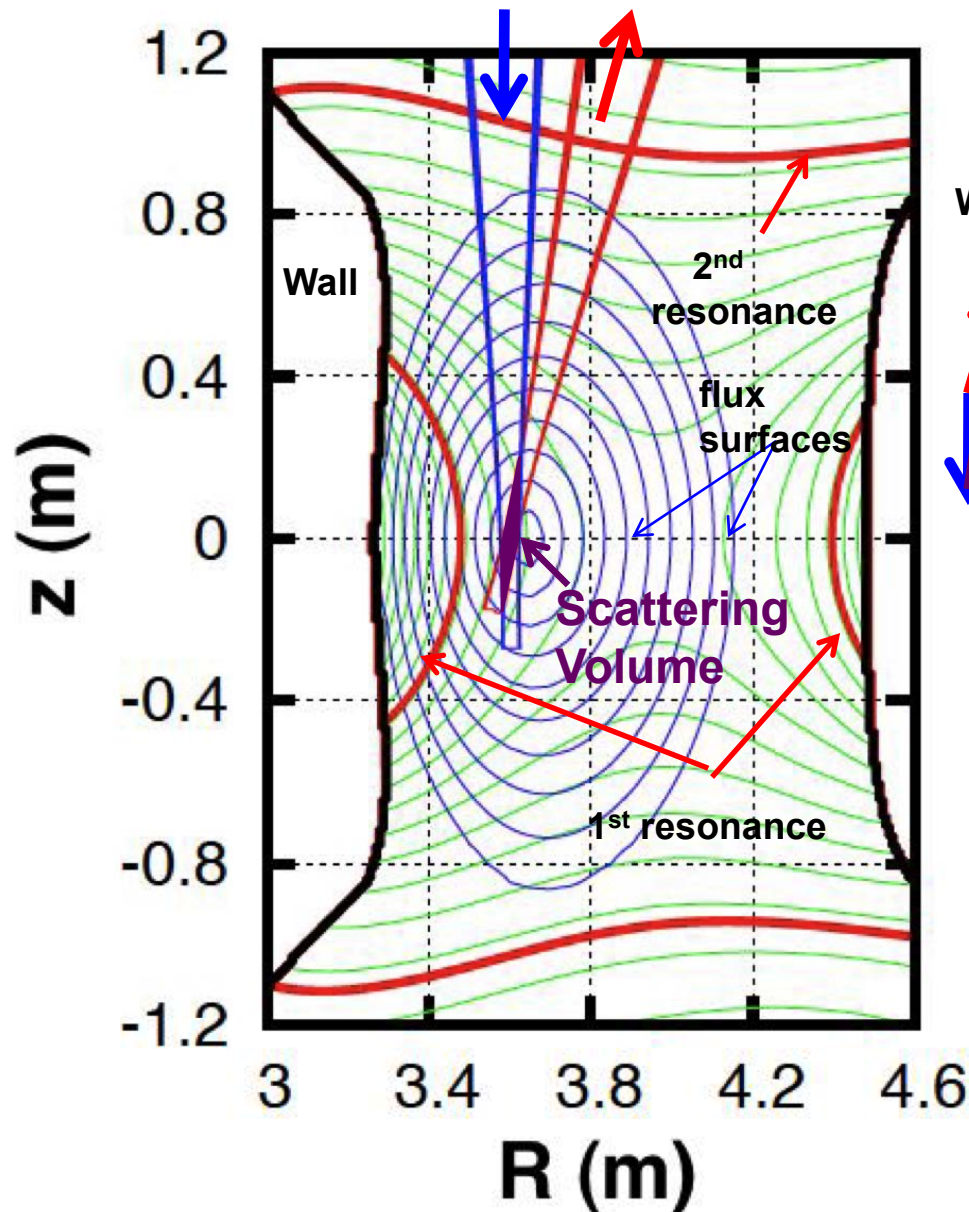

$B=2.40$ T

$R=3.6$ m

$k^\delta \sim$ near perpendicular

$k^\delta \angle B \sim 80$ degree

1st resonance exists in the confinement region even avoiding it on the line of sight.

O-mode for both probing and receiving beams.

History of collective Thomson scattering. This diagnostic had a hard time.

Collective Thomson scattering has sensitivity to ion thermal motion. From late 1970's, the developments started. However, it was not very successful (pioneer works were done by Woskov, Behn). This is because good source was not available for collective Thomson ($\lambda > 0.5\text{mm}$). This is big contrast to incoherent Thomson scattering. Good source are available around 600nm (Ruby laser) from 1960's. In 1980's, charge exchange spectroscopy (CXRS) using heating NBI appeared and it provided "*impurity*" ion temperature with good spatial resolution ($\sim\text{cm}$) and reasonable time resolution ($\sim 100\text{msec}$). People started use CXRS.

However, in the end of 1980's, collective Thomson was proposed to measure fusion product in the future reactor (by Costley, Bindslev). Also, in the experimental device, it was proposed to measure externally injected fast ion, which can simulate fusion products.

Preliminary data was obtained in JET in the beginning of 1990's. In 2000's, excellent data was obtained in TEXTOR and ASDEX-U. In LHD, collective Thomson started since 2008.

Upgrading after last LAPD

1. Increase of channel of filter bank from 8 to 40.
2. Install of fast digital oscilloscope and fast digitizer
3. Change of scattering geometry
Tangential viewing to increase contribution of parallel moving fast ion
4. Fast sweeping antenna to check antenna alignment

Change of the gyrotron frequency was measured fast sampling digitizer

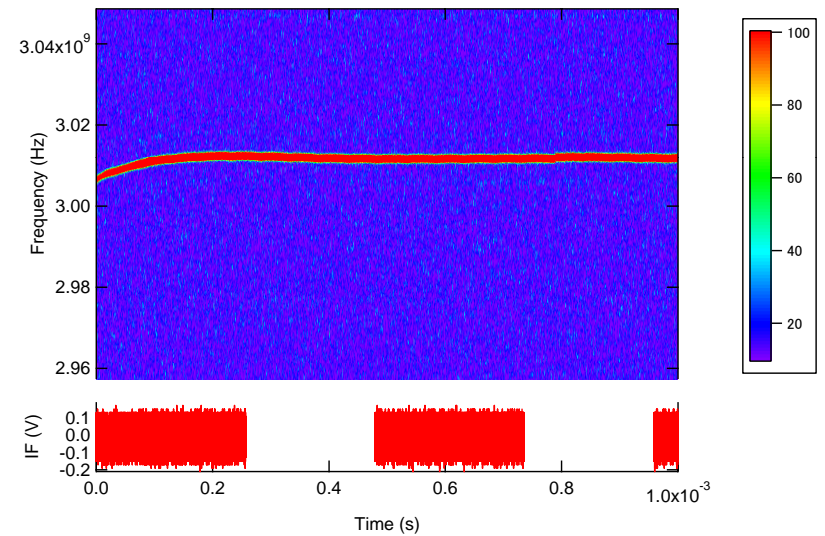
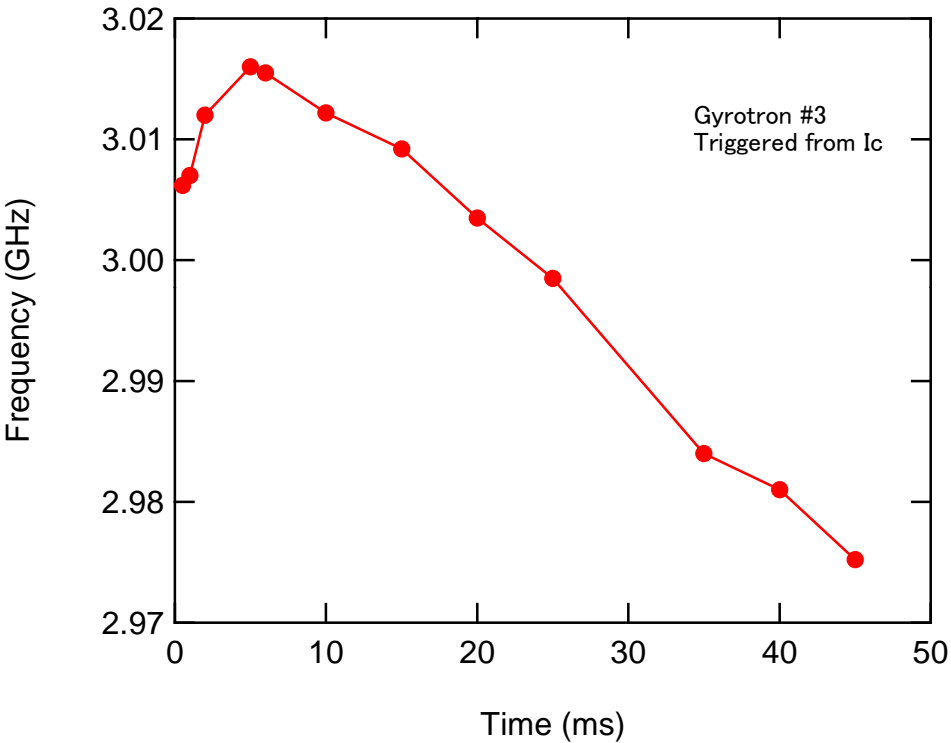

RF & IF filter characteristics

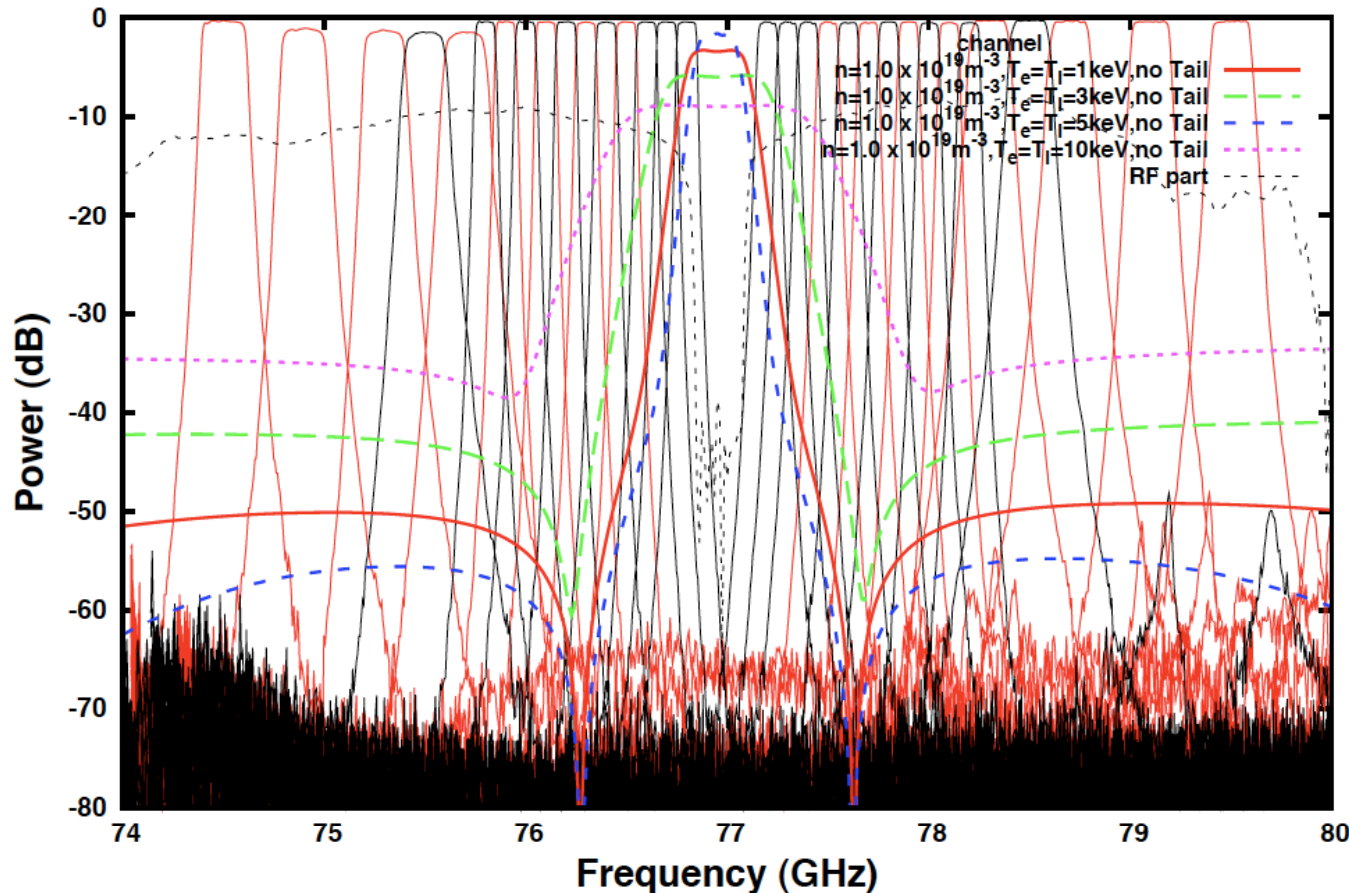

All RF & IF components used are measured by Vector Network Analyzer (VNA)

Central dense channels give bulk ion temperature. Sparse channels of both side give high energy ion.

Velocity distribution function $g(u)$

$f(v_{\parallel}, v_{\perp})$ is projected onto fluctuation \mathbf{k}^{δ}

- For understanding the measured CTS spectrum, distribution function $f(v_{\parallel}, v_{\perp})$ is calculated by GNET code with measured T and n.

$$g(u, \phi) = \int \int_{-\infty}^{\infty} f(v_{\parallel}, v_{\perp}) \delta\left(\frac{\mathbf{v} \cdot \mathbf{k}}{|\mathbf{k}|} - u\right) dv_{\parallel} dv_{\perp}$$

- Fast ion density of $\sim 10^{17} \text{m}^{-3}$
- We have just started the calculation, and will compare between the experimental and the calculated results.

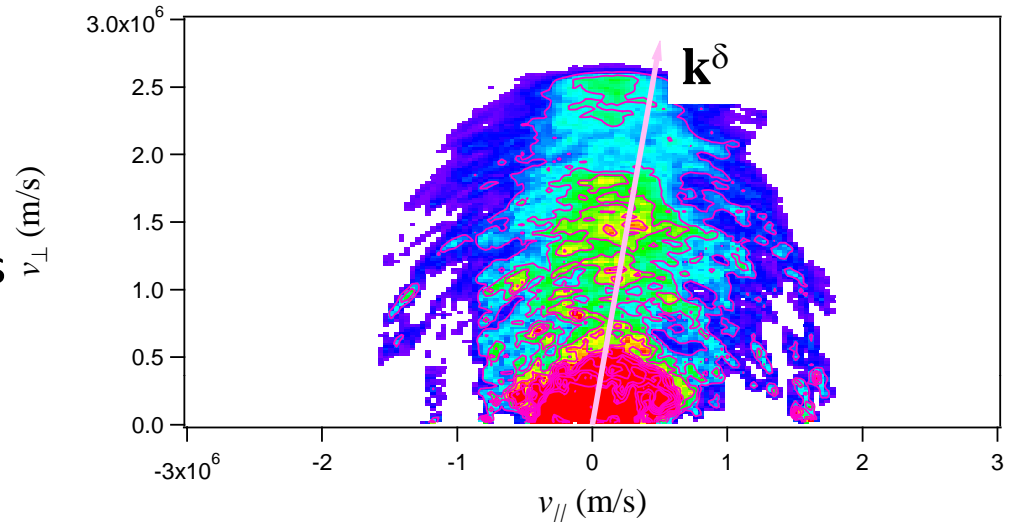

Calculated distribution function $f(v_{\parallel}, v_{\perp})$ for LHD#97496 $t=0.451\text{s}$.

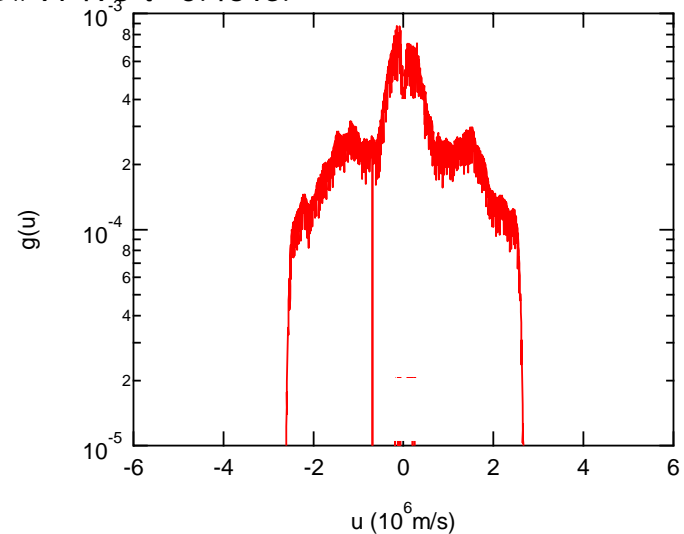

Distribution function $g(u)$ projected onto \mathbf{k}^{δ} .

Comparison of Exp. / Cal. Spectrum

○ 1Co+2Ctr

● 1Co+2Ctr+1Perp

— Te=0.8keV, Ti=0.7keV, without NBI

— Te=0.8keV, Ti=0.7keV, with 40 keV NBI

— Te=0.8keV, Ti=5 keV, with 40 keV NBI

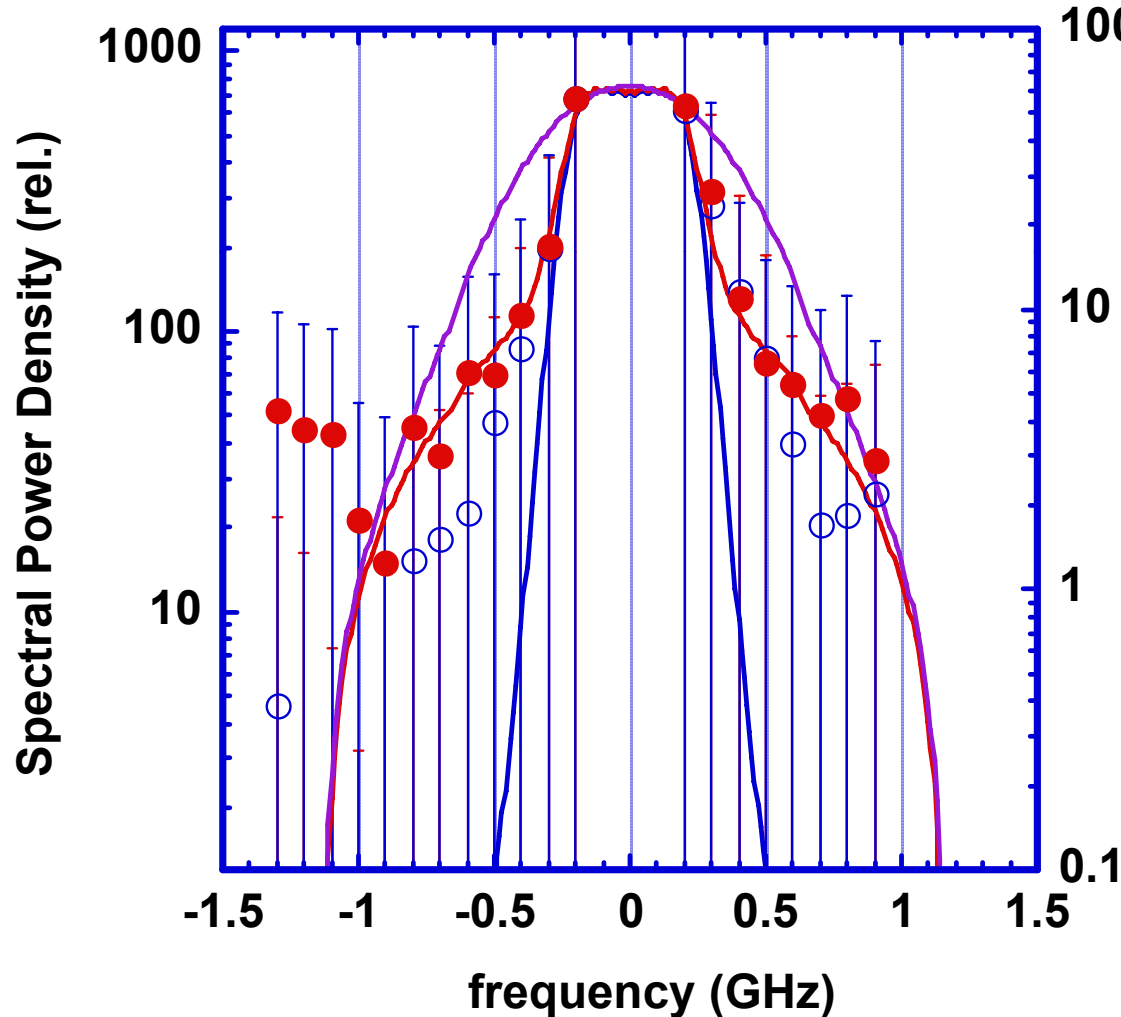

100 Measured data are used for calculation.

- $T_e=0.8\text{keV}$
- $T_{Ar}=0.7\text{keV}$
- $n_e=2.5\times 10^{19}\text{m}^{-3}$
- $n_{fast}=0.25\times 10^{19}\text{m}^{-3}$

- $T_i=0.7\text{keV}$ is better fitting than $T_i=5\text{keV}$.
- Measured data seems to have an offset of +0.1GHz.
- P(3.6,0,0), R(3.6,0,0)

Method of analysis

- Raw data of several modulation periods are rearranged in time relative to the turn on/off time
- These rearranged data are fitted with the function

$$V_i = (a + \delta a \cdot H(t))t + b + \delta b \cdot H(t)$$

Here, a , δa , b , δb are fitting parameters and $H(t)$ is Heaviside step function defined by

$$H(t) \equiv \begin{cases} 1 & \text{for } t \geq 0 \\ 0 & \text{for } t < 0 \end{cases}$$

- δa corresponds to background increments/decrements due to heating (change in slope)
- δb corresponds to increment/decrement due to scattered signal over background (stepwise change)