



A Method for Effective Conversion of Saccharides to Furfural Compounds

Malcho, Phillip; Andersen, Jonas; Kunov-Kruse, Andreas Jonas; Ståhl, Kenny; Riisager, Anders; Fehrmann, Rasmus

Publication date:
2015

Document Version
Publisher's PDF, also known as Version of record

[Link back to DTU Orbit](#)

Citation (APA):
Malcho, P., Andersen, J., Kunov-Kruse, A. J., Ståhl, K., Riisager, A., & Fehrmann, R. (2015). A Method for Effective Conversion of Saccharides to Furfural Compounds. (Patent No. WO2015004273).

General rights

Copyright and moral rights for the publications made accessible in the public portal are retained by the authors and/or other copyright owners and it is a condition of accessing publications that users recognise and abide by the legal requirements associated with these rights.

- Users may download and print one copy of any publication from the public portal for the purpose of private study or research.
- You may not further distribute the material or use it for any profit-making activity or commercial gain
- You may freely distribute the URL identifying the publication in the public portal

If you believe that this document breaches copyright please contact us providing details, and we will remove access to the work immediately and investigate your claim.

(12) INTERNATIONAL APPLICATION PUBLISHED UNDER THE PATENT COOPERATION TREATY (PCT)

(19) World Intellectual Property
Organization
International Bureau



WIPO | PCT



(10) International Publication Number
WO 2015/004273 A1

(43) International Publication Date
15 January 2015 (15.01.2015)

- (51) International Patent Classification:
C07D 307/50 (2006.01)
- (21) International Application Number:
PCT/EP2014/064942
- (22) International Filing Date:
11 July 2014 (11.07.2014)
- (25) Filing Language: English
- (26) Publication Language: English
- (30) Priority Data:
13176259.3 12 July 2013 (12.07.2013) EP
- (71) Applicant: DANMARKS TEKNISKE UNIVERSITET
[DK/DK]; Anker Engélunds Vej 1, DK-2800 Kgs. Lyngby (DK).
- (72) Inventors: MALCHO, Phillip; Parmagade 17, 2. tv., DK-2300 Copenhagen S (DK). ANDERSEN, Jonas; Otto Mallings Gade 4, 2. tv., DK-2100 Copenhagen Ø (DK). KUNOV-KRUSE, Andreas; Kantorparken 33, 3., DK-2400 Copenhagen NV (DK). STÄHL, Kenny; Birkholmsvej 5, DK-2800 Kgs. Lyngby (DK). RIISAGER, Anders; Rønnevangshusene 138, DK-2630 Taastrup (DK). FEHRMAN, Rasmus; Eckersbergsgade 23, DK-2100 Copenhagen Ø (DK).
- (74) Agents: THORSEN, Jesper et al.; Inspicos A/S, P.O. Box 45, Kogle Allé 2, DK-2970 Hørsholm (DK).
- (81) Designated States (unless otherwise indicated, for every kind of national protection available): AE, AG, AL, AM, AO, AT, AU, AZ, BA, BB, BG, BH, BN, BR, BW, BY, BZ, CA, CH, CL, CN, CO, CR, CU, CZ, DE, DK, DM, DO, DZ, EC, EE, EG, ES, FI, GB, GD, GE, GH, GM, GT, HN, HR, HU, ID, IL, IN, IR, IS, JP, KE, KG, KN, KP, KR, KZ, LA, LC, LK, LR, LS, LT, LU, LY, MA, MD, ME, MG, MK, MN, MW, MX, MY, MZ, NA, NG, NI, NO, NZ, OM, PA, PE, PG, PH, PL, PT, QA, RO, RS, RU, RW, SA, SC, SD, SE, SG, SK, SL, SM, ST, SV, SY, TH, TJ, TM, TN, TR, TT, TZ, UA, UG, US, UZ, VC, VN, ZA, ZM, ZW.
- (84) Designated States (unless otherwise indicated, for every kind of regional protection available): ARIPO (BW, GH, GM, KE, LR, LS, MW, MZ, NA, RW, SD, SL, SZ, TZ, UG, ZM, ZW), Eurasian (AM, AZ, BY, KG, KZ, RU, TJ, TM), European (AL, AT, BE, BG, CH, CY, CZ, DE, DK, EE, ES, FI, FR, GB, GR, HR, HU, IE, IS, IT, LT, LU, LV, MC, MK, MT, NL, NO, PL, PT, RO, RS, SE, SI, SK, SM, TR), OAPI (BF, BJ, CF, CG, CI, CM, GA, GN, GQ, GW, KM, ML, MR, NE, SN, TD, TG).
- Declarations under Rule 4.17:
— of inventorship (Rule 4.17(iv))
- Published:
— with international search report (Art. 21(3))



WO 2015/004273 A1

(54) Title: A METHOD FOR EFFECTIVE CONVERSION OF SACCHARIDES TO FURFURAL COMPOUNDS

(57) Abstract: The present invention relates to a method for the effective conversion of one or more mono-, di-, oligo- or polysaccharides to hydroxymethylfurfural (HMF), in an ionic liquid by means of a chromium catalyst mixture comprising chromium (II) and chromium (III) species. The invention also provides a catalyst mixture suitable for this conversion.

A METHOD FOR EFFECTIVE CONVERSION OF SACCHARIDES TO FURFURAL COMPOUNDS

FIELD OF THE INVENTION

The present invention relates to a method for the effective conversion of one or more mono-, di-, oligo- or polysaccharides to furfural or hydroxymethylfurfural (HMF), in an ionic liquid by means of a chromium catalyst mixture. The catalyst mixture is provided in-situ by reduction of a portion of a chromium (III) species to a chromium (II) species. The invention also provides a catalyst mixture suitable for this conversion.

BACKGROUND OF THE INVENTION

Furfural and Hydroxymethylfurfural (HMF) are important chemical feedstocks and useful chemical intermediates which can be synthesised by triple dehydration of saccharides. Although this furfural and HMF synthesis seems straightforward on paper, research efforts have focussed on improving the efficiency of this reaction, e.g. by using catalysts.

Promising results have been achieved using chromium salts as catalysts. For instance, Zhao et al. *Science* 2007, 316, 1597-1600 has used metal halides in the ionic liquid 1-ethyl-3-methylimidazolium chloride ([EMIm]Cl). Both CrCl₂ and CrCl₃.6(H₂O) catalysed the conversion of glucose to furfural.

Chromium (III) is the most common and most thermodynamically stable oxidation state of Cr. However, the conversion of glucose to HMF catalysed by Cr(III) is inhibited by both the water produced in the dehydration steps, and by the HMF product itself. Presumably due to the strong inhibition, maximum conversions of glucose to HMF catalysed by Cr(III) are around 70-75%, with the last few % conversion being very slow (Zhao et al, *ibid*, and *Tetrahedron Letters* 2009, 50, 5403-5405).

D1 (J. Lee et al. *Carbohydrate Research* vol. 346, 2, February 2011, pages 177-182) discloses production of HMF from acorn-derived sugars in the presence of metal catalysts (Fig. 1). Various catalysts are used, including a mixed CrII/CrIII catalyst. Ionic liquids may be used as solvents.

The need remains for an efficient catalytic method for the conversion of saccharides to HMF, in which the drawbacks of the known methods are reduced or altogether avoided. In

particular, given the promising catalysis of this conversion by Cr(III), improved methods based on chromium salts would be of particular interest.

SUMMARY OF THE INVENTION

It has been found by the present inventors that chromium (III) catalysts initially show a very high catalytic activity and selectivity towards isomerizations of aldose sugars to ketose form and the subsequent dehydration of the ketose form to furfuranic compounds. The catalytic activity is possibly related to a labile hexachlorochromium (III) species which easily coordinates to the oxygens on the sugars. However the catalyst is very sensitive to product inhibition as the lability is lost when water and furfuranic compounds coordinate to the active chromium species. This results in a pronounced inhibition at higher conversions. However the inventors has shown that mixing the active oxidation state, chromium(III), with an suited amount of chromium(II) this deactivation can be avoided due to the high lability of chromium (II).

So, in a first aspect the present invention relates to a method for the conversion of one or more mono-, di-, oligo- or polysaccharides to furfural or hydroxymethylfurfural (HMF), said method comprising the steps of:

- a. providing a reaction mixture comprising a non-aqueous solvent, said one or more mono-, di-, oligo- or polysaccharides, and a chromium catalyst mixture, said catalyst mixture comprising Cr(II) and Cr(III) species, and wherein the catalyst mixture is provided in-situ by reduction of a portion of a chromium (III) species to a chromium (II) species; and
- b. converting said one or more mono-, di-, oligo- or polysaccharides to hydroxymethylfurfural (HMF) by use of said catalyst mixture.

The invention also provides a catalyst mixture for the conversion of one or more mono-, di-, oligo- or polysaccharides to furfural or hydroxymethylfurfural (HMF), said catalyst mixture comprising Cr(II) and Cr(III) species.

Further details of the invention are described in the following description and the dependent claims.

DETAILED DISCLOSURE OF THE INVENTION

Specific embodiments of the invention

The invention thus provides a method for the conversion of one or more mono-, di-, oligo- or polysaccharides (herein also called "saccharides") to furfural or hydroxymethylfurfural (HMF).

- 5 Scheme 1 shows proposed reaction pathways for HMF formation: in the first and rate-determining step, glucose isomerizes to fructose which is then in the subsequent steps rapidly dehydrated to yield hydroxymethylfurfural. Chromium (III) catalyses both the glucose isomerization and the dehydrations.

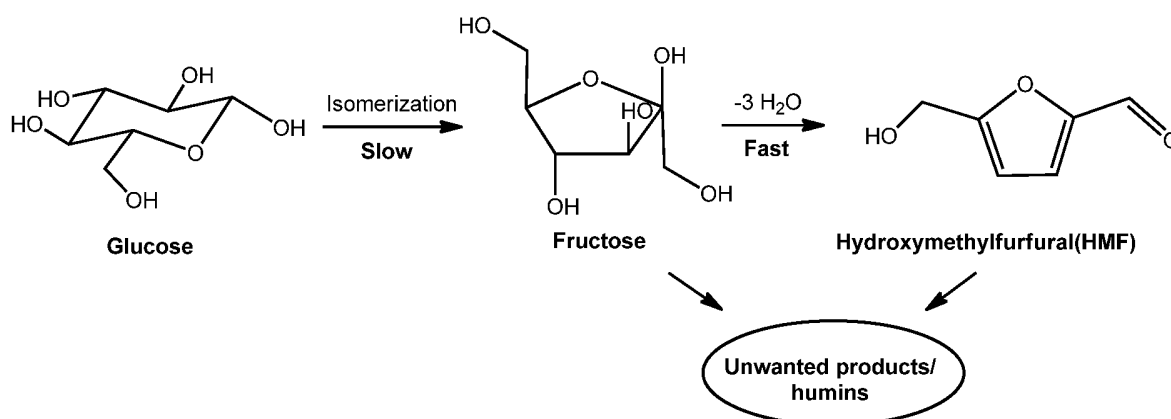

10

Scheme 1. Proposed reaction scheme for conversion of glucose to HMF

- Saccharides suitable for use in the present invention are preferably monosaccharide, suitably a C₃-C₆ monosaccharide, such as a C₅ or C₆ monosaccharide, preferably glucose or xylose. C₆ saccharides are converted to HMF while C₅ saccharides are converted to furfural. However, disaccharides (e.g. sucrose, maltose, xylobiose, cellobiose, lactose), oligosaccharides and polysaccharides may also be converted to HMF or furfural in the method of the invention. Particular polysaccharides which may be converted to HMF or furfural in the method of the invention could be cellulose, hemicellulose, xylan, amylose/starch, chitin and pectin.

- In the first step (a) of the method, a reaction mixture is provided. The reaction mixture comprises a non-aqueous solvent, said one or more mono-, di-, oligo- or polysaccharides, and a chromium catalyst mixture.

The non-aqueous solvent according to the invention is a solvent in which the starting saccharides, the product HMF and the catalyst are soluble; i.e. a homogeneous system is

provided. Mixtures of one or more non-aqueous solvents are also included within the term "non-aqueous solvent". The non-aqueous solvent is suitably an ionic liquid, preferably an ionic liquid comprising a halide anion, such as e.g. 1-butyl-3-methylimidazolium chloride ([BMIm]Cl) and 1-ethyl-3-methylimidazolium chloride ([EMIm]Cl).

5 Suitable ionic liquids comprise at least one cation having one of the following structures:

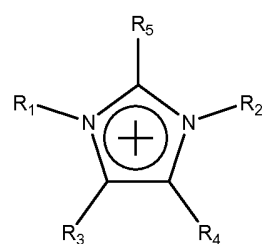

Imidazolium ion

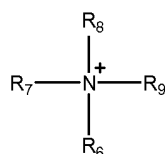

Ammonium ion

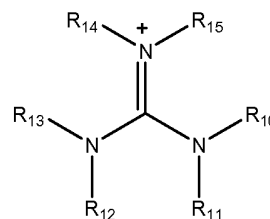

Guanidinium ion

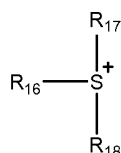

Sulfonium ion

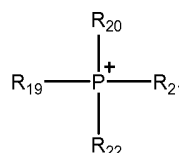

Phosphonium ion

wherein

- $R_1, R_2, R_3, R_4, R_5, R_6, R_7, R_8, R_9, R_{10}, R_{11}, R_{12}, R_{13}, R_{14}, R_{15}, R_{16}, R_{17}, R_{18}, R_{19}, R_{20}, R_{21}$ and R_{22} can be, independently, hydrogen, alkyl, halogenated alkyl, aminoalkyl, hydroxyalkyl, alkoxyalkyl, alkenyl, alkynyl, aryl, heteroaryl, cycloalkyl, cycloalkenyl, heterocycloalkyl, or heterocycloalkenyl;
- the positively charged P, N and S atoms may individually be part of heterocyclic or heteroaromatic structures in that:
 - o two of $R_{20}, R_{21}, R_{22}, R_{23}$, e.g. R_{21} and R_{22} are fused such that a cyclic phosphonium ion is formed, or
 - o two of R_6, R_7, R_8, R_9 e.g. R_6 and R_7 are fused, such that a cyclic ammonium ion is formed, such as a pyridinium ion, or,
 - o two of R_{11} and R_{12}, R_{13} and R_{14}, R_{15} and R_{10} , e.g. R_{11} and R_{12} are fused, such that a cyclic guanidinium ion is formed, or,

o two of R₁₆, R₁₇ and R₁₈ e.g. R₁₆ and R₁₇ are fused, such that a cyclic sulfonium ion is formed,

optionally one or more cations selected from inorganic cations such as Li⁺, Na⁺ and K⁺, and one or more anions selected from C₁-C₆ alkanooates such as acetate, arylcarboxylates such as benzoate, C₁-C₆ alkylsulfates such as ethyl sulfate, C₁-C₆ alkylsulfonates, C₁-C₆ perfluoroalkylsulfonates such as triflate, C₁-C₆ perfluoroalkanoates such as trifluoroacetate, C₁-C₆ perfluoroalkylsulfonimides such as bis(trifluoromethylsulfonyl) imide (triflic imide), tetrafluoroborate, hexafluorophosphate, sulfate, nitrate and halides such as chloride, bromide or iodide.

10 Other suitable solvents include those which can coordinate to metal ions in solution, e.g. DMSO, THF, DMF. Suitably, the one or more mono-, di-, oligo- or polysaccharides and the chromium catalyst mixture are both soluble in the non-aqueous solvent.

The catalyst mixture is significant, as it comprises Cr(II) and Cr(III) species. This means that chromium is present in both the +2 and the +3 oxidation state. The catalyst mixture used in the method suitably comprises 5-20 mol% Cr(II).

Without being bound by theory, it seems that complexes in mixtures of chromium (II) and chromium (III) can easily swap oxidation state by electron transfer through temporary ligand bridges. In this way, inhibited Cr(III) complexes can readily be regenerated into active catalytic species. Therefore, the present inventors have realised that reducing even just trace amounts of chromium (III) to chromium (II), as per the method of the invention, will increase the reactivity significantly by easing the complex formation kinetics by orders of magnitude. A proposed mechanism for this is set out in Scheme 2.

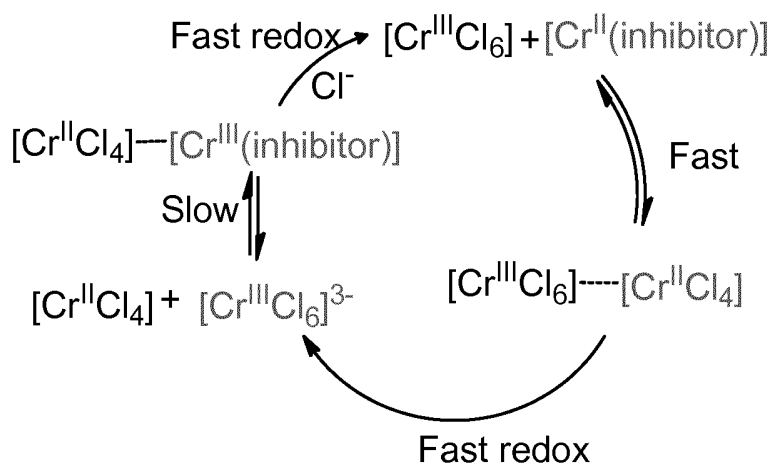

Scheme 2: proposed mechanism for regeneration of $[\text{CrCl}_6]^{3-}$ in the presence of Cr(II)

In step (b) of the method, said one or more mono-, di-, oligo- or polysaccharides are converted to furfural or hydroxymethylfurfural (HMF) by use of said catalyst mixture.

5 The catalyst mixture is provided in-situ by reduction of a portion of a chromium (III) species to a chromium (II) species. In other words, the reaction mixture initially comprises Cr(III) which is partially reduced in situ to Cr(II). It is important that reduction is only partial – i.e. that not all Cr(III) is reduced to Cr(II). In a particular aspect, the catalyst does not comprise any Cr(II) prior to reduction of Cr(III) to Cr(II).

10 Reduction of Cr(III) to Cr(II) is suitably carried out by means of a reducing agent. The reducing agent may also be soluble in the non-aqueous solvent, meaning that the entire reaction mixture is homogeneous. The reduction $\text{Cr}^{3+} + \text{e}^- \rightarrow \text{Cr}^{2+}$ has a small standard reduction potential of ca. -0.40V, so a range of reducing agents may be used. Suitable reducing agents include metals in oxidation state 0, such as Cu, Zn, Al, Fe, Cr, Mn, Ti, alkali metal, or alkaline earth metals. Further reducing agents include oxalic acid, metal hydrides
15 such as LiAlH_4 and borohydrides such as diborane.

As an alternative to a reducing agent, reduction of Cr(III) to Cr(II) may be carried out by means of electrochemistry. In other words, a supply of electrons by means of an electrical circuit may effect the in-situ reduction of Cr(III) to Cr(II). Electrodes in the reactor could supply a suitable potential which reduces Cr(III) to Cr(II) without being so large that metallic
20 chromium is formed. The current could be switched off when an suitable amount of Cr(II) is formed. The amount of Cr(II) could in this way be efficiently controlled by applying shorter pulses of current whenever needed to ensure a suitable amount of Cr(II)

According to this particular aspect, the chromium (III) salt may be provided in the form of CrCl_3 . Suitably, the chromium (III) salt may initially be present at a concentration of 1-100
25 mol%, preferably 5-20 mol% (with respect to the saccharide). Suitably, at least 5-50 mol% of the Cr(III) is reduced to Cr(II).

Generally, one or more mono-, di-, oligo- or polysaccharides and a chromium (III) species may be combined in a non-aqueous solvent, followed by the step of: reducing a portion of the chromium (III) to chromium (II). As an alternative, a portion of chromium (III) species is
30 reduced to chromium (II) to form the catalyst mixture, prior to combining with said one or more mono-, di-, oligo- or polysaccharides in an ionic liquid.

The invention also provides a catalyst mixture for the conversion of one or more mono-, di-, oligo- or polysaccharides to furfural or hydroxymethylfurfural (HMF), said catalyst mixture comprising Cr(II) and Cr(III) species. Suitably, the catalyst mixture according to the invention, further comprises an ionic liquid in which the Cr(II) and Cr(III) species are dissolved. A homogeneous solution comprising Cr(II) and Cr(III) species dissolved in an ionic liquid is thus provided. Suitable ionic liquids are preferably those which comprise a halide anion, such as e.g. [BMIm]Cl and [EMIm]Cl.

The catalyst mixture according to the invention may comprise 1-90 mol% Cr(II), preferably 1-50 mol% Cr(II), more preferably 2-25 mol% Cr(II).

10 EXAMPLES

Example 1- Dehydration of glucose to 5-hydroxymethylfurfural in [BMIm]Cl solution was prepared by mixing 5 g dry 1-butyl-3-methylimidazolium chloride ([BMIm]Cl) with 120 mg of $\text{CrCl}_3 \cdot 6\text{H}_2\text{O}$ and 19 mg of CrCl_2 in a beaker inside a glovebox with a dry nitrogen atmosphere. A small Teflon-coated magnet was added to the mixture and the mixture was gently heated at 80°C until all chromium salt was dissolved. Then, 5 g of a [BMIM]Cl solution containing 20 wt. % glucose was added to the mixture. The resulting chromium/glucose solution was dispersed in four test tubes, each containing 2 g solution. A Teflon-coated magnet was added to each test tube and each test tube was sealed carefully using a special rubber sealed lid. The four test tubes were then heated to respectively 90, 100, 110 and 120°C in oil baths, under a nitrogen atmosphere while magnetically stirring the solutions, while the catalytic reaction took place. Aliquots were taken from the tubes during the reactions and the concentrations of HMF and glucose were determined by HPLC and FTIR.

Example 2- Dehydration of glucose to 5-hydroxymethylfurfural in [BMIm]Cl

5 g of a 1-butyl-3-methylimidazolium chloride ([BMIm]Cl) solution containing 10 wt. % glucose and 10 mol% CrCl_3 catalyst (with respect to glucose) (20) was transferred into a 20 mL glass beaker (22) supplied with two gold electrodes (10, 12), while stirred with a magnetic stirring bar (14), see Figure 1. The reactor was sealed and immersed into an oil bath at 110°C . Initially a potential of around 0.6V (with respect to the standard hydrogen electrode) was applied to the solution enabling a fraction of the Cr^{3+} to be reduced to Cr^{2+} , while ensuring that no chromium was reduced to metallic chromium, which requires a higher reduction potential. After a short period of time the potential was removed and the reaction was carried out for 3 hours. During this period aliquots of the reaction mixture was analysed and the concentrations of HMF and glucose determined by HPLC.

Example 3- Dehydration of glucose to 5-hydroxymethylfurfural in [BMIm]Cl

10 g of 1-butyl-3-methylimidazolium chloride ([BMIm]Cl) were mixed with 0.15 g of $\text{CrCl}_3 \cdot 6(\text{H}_2\text{O})$, 1 g of glucose and 10 mg of zinc powder. The solution was heated to 110 °C in a sealed glass reactor using an oil bath under magnetic stirring. The reaction course was
5 determined by HPLC and FTIR analysis.

Although the invention has been described with reference to a number of particular embodiments and Schemes, the invention should not be considered as limited thereto. The person skilled in the art will be able to combine features of the invention as desired, while remaining within the scope of the invention.

10 *Example 4 - Dehydration of glucose to 5-hydroxymethylfurfural in [BMIm]Cl*

To 1.00 g 1-butyl-3-methylimidazolium chloride ([BMIm]Cl) (5.73 mmol) was added 14.8 mg $\text{CrCl}_3 \cdot 6\text{H}_2\text{O}$ or 6.8 mg CrCl_2 (0.056 mmol) where after the mixture was stirred for 15 min. to ensure complete solvation. To the purple solution was then added 100 mg D-glucose (0.56 mmol) and the system stirred at room temperature for 15 min. In order to obtain time
15 resolved samples, the solution was heated to 80 °C for the duration needed and the solution flash frozen on an acetone/dry-ice bath. The reaction was monitored using EXAFS, EPR (Electron Paramagnetic Resonance), IR, Mass Spectrometry and UV-vis (optical absorption spectroscopy).

It was showed that the temperature played a major part in the dehydration of glucose, and
20 the higher temperature the faster reaction. Ranging from more than 2 hours to 16 minutes to reach completion with 80 °C and 130 °C respectively. It was also shown, that running the reaction under a steady flow off nitrogen provided a faster reaction, and therefore we concluded that the chromium catalyzed dehydration of glucose was hindered by the formation of water.

25

CLAIMS

1. A method for the conversion of one or more mono-, di-, oligo- or polysaccharides to furfural or hydroxymethylfurfural (HMF), said method comprising the steps of:
 - 5 a. providing a reaction mixture comprising a non-aqueous solvent, said one or more mono-, di-, oligo- or polysaccharides, and a chromium catalyst mixture, said catalyst mixture comprising chromium (II) and chromium (III) species, and wherein the catalyst mixture is provided in-situ by reduction of a portion of a chromium (III) species to a chromium (II) species; and
 - 10 b. converting said one or more mono-, di-, oligo- or polysaccharides to furfural or hydroxymethylfurfural (HMF) by use of said catalyst mixture.
2. The method according to claim 1, wherein reduction of chromium (III) to chromium (II) is carried out by means of a reducing agent.
3. The method according to claim 2, wherein the reducing agent is a metal in oxidation state 0, such as Cu, Zn, Al, Fe, Cr, Mn, Ti, alkali metal, or alkaline earth metal.
- 15 4. The method according to claim 1, wherein reduction of chromium (III) to chromium (II) is carried out by means of electrochemistry.
5. The method according to any of claims 1-4, wherein the catalyst does not comprise any chromium (II) prior to reduction of chromium (III) to chromium (II).
6. The method according to any one of the preceding claims, wherein the saccharide is a
20 monosaccharide, suitably a C₃-C₆ monosaccharide, such as a C₅ or C₆ monosaccharide, preferably glucose or xylose.
7. The method according to any one of the preceding claims, wherein the chromium (III) salt is provided in the form of CrCl₃.
8. The method according to any one of the preceding claims, wherein the chromium (III)
25 salt is initially present at a concentration of 1-100 mol%, preferably 5-20 mol%, with respect to the saccharide concentration.

9. The method according to any one of the preceding claims, wherein said non-aqueous solvent is an ionic liquid.

10. A catalyst mixture for the conversion of one or more mono-, di-, oligo- or polysaccharides to furfural or hydroxymethylfurfural (HMF), said catalyst mixture comprising chromium (II) and chromium (III) species.

11. A catalyst mixture according to claim 10, further comprising an ionic liquid in which the chromium (II) and chromium (III) species are dissolved.

12. A catalyst mixture according to any one of claims 10-11, comprising 1-90 mol% Cr(II), preferably 1-50 mol% Cr(II), more preferably 2-25 mol% Cr(II).

Fig. 1

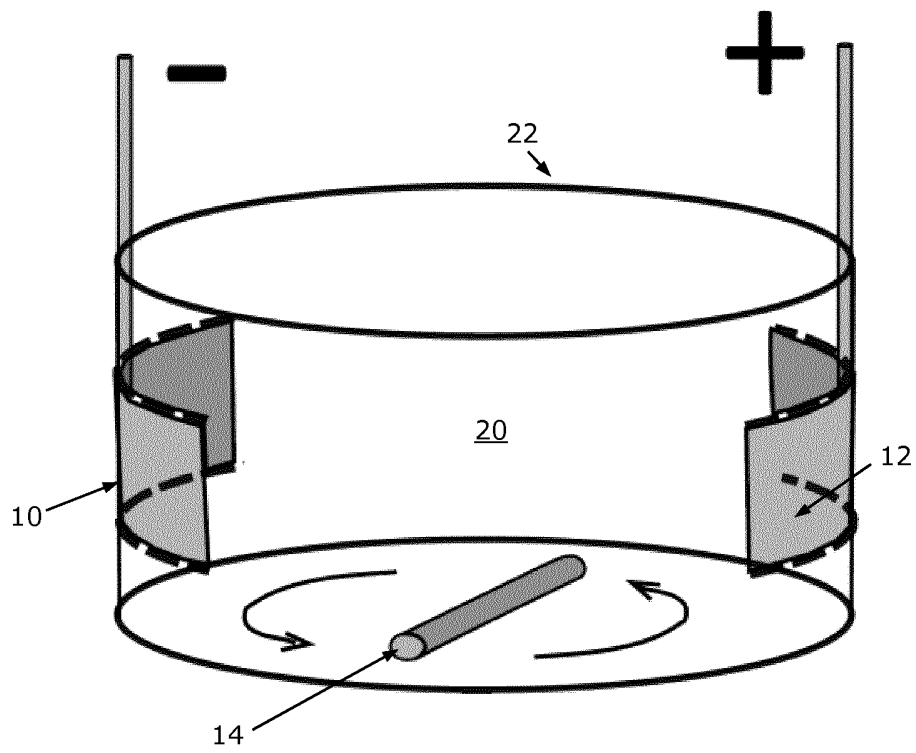

INTERNATIONAL SEARCH REPORT

International application No PCT/EP2014/064942

A. CLASSIFICATION OF SUBJECT MATTER INV. C07D307/50 ADD.				
According to International Patent Classification (IPC) or to both national classification and IPC				
B. FIELDS SEARCHED				
Minimum documentation searched (classification system followed by classification symbols) C07D				
Documentation searched other than minimum documentation to the extent that such documents are included in the fields searched				
Electronic data base consulted during the international search (name of data base and, where practicable, search terms used) EPO-Internal, WPI Data				
C. DOCUMENTS CONSIDERED TO BE RELEVANT				
Category*	Citation of document, with indication, where appropriate, of the relevant passages	Relevant to claim No.		
X	LEE J W ET AL: "Chromium halides mediated production of hydroxymethylfurfural from starch-rich acorn biomass in an acidic ionic liquid", CARBOHYDRATE RESEARCH, PERGAMON, GB, vol. 346, no. 2, 1 February 2011 (2011-02-01), pages 177-182, XP027600719, ISSN: 0008-6215, DOI: 10.1016/J.CARRES.2010.11.009 [retrieved on 2011-01-13] Abstract: 2nd sentence. Paragraphs 3.3 and 4.; figures 1,6 ----- -/--	1-12		
<table style="width: 100%; border: none;"> <tr> <td style="width: 50%; border: none;"><input checked="" type="checkbox"/> Further documents are listed in the continuation of Box C.</td> <td style="width: 50%; border: none;"><input checked="" type="checkbox"/> See patent family annex.</td> </tr> </table>			<input checked="" type="checkbox"/> Further documents are listed in the continuation of Box C.	<input checked="" type="checkbox"/> See patent family annex.
<input checked="" type="checkbox"/> Further documents are listed in the continuation of Box C.	<input checked="" type="checkbox"/> See patent family annex.			
* Special categories of cited documents :				
"A" document defining the general state of the art which is not considered to be of particular relevance "E" earlier application or patent but published on or after the international filing date "L" document which may throw doubts on priority claim(s) or which is cited to establish the publication date of another citation or other special reason (as specified) "O" document referring to an oral disclosure, use, exhibition or other means "P" document published prior to the international filing date but later than the priority date claimed	"T" later document published after the international filing date or priority date and not in conflict with the application but cited to understand the principle or theory underlying the invention "X" document of particular relevance; the claimed invention cannot be considered novel or cannot be considered to involve an inventive step when the document is taken alone "Y" document of particular relevance; the claimed invention cannot be considered to involve an inventive step when the document is combined with one or more other such documents, such combination being obvious to a person skilled in the art "&" document member of the same patent family			
Date of the actual completion of the international search	Date of mailing of the international search report			
9 September 2014	15/09/2014			
Name and mailing address of the ISA/ European Patent Office, P.B. 5818 Patentlaan 2 NL - 2280 HV Rijswijk Tel. (+31-70) 340-2040, Fax: (+31-70) 340-3016	Authorized officer Von Daacke, Axel			

INTERNATIONAL SEARCH REPORT

International application No

PCT/EP2014/064942

C(Continuation). DOCUMENTS CONSIDERED TO BE RELEVANT		
Category*	Citation of document, with indication, where appropriate, of the relevant passages	Relevant to claim No.
A	WO 2009/155297 A1 (WISCONSIN ALUMNI RES FOUND [US]; BINDER JOSEPH BARTHOLOMEW [US]; RAINE) 23 December 2009 (2009-12-23) the whole document -----	1-12
A	HAIBO ZHAO ET AL: "Metal Chlorides in Ionic Liquid Solvents Convert Sugars to 5-Hydroxymethylfurfural", SCIENCE, AMERICAN ASSOCIATION FOR THE ADVANCEMENT OF SCIENCE, WASHINGTON, DC; US, vol. 316, 15 June 2007 (2007-06-15), pages 1597-1600, XP002468488, ISSN: 0036-8075, DOI: 10.1126/SCIENCE.1141199 cited in the application the whole document -----	1-12

INTERNATIONAL SEARCH REPORT

Information on patent family members

International application No

PCT/EP2014/064942

Patent document cited in search report	Publication date	Patent family member(s)	Publication date
WO 2009155297 A1	23-12-2009	CA 2726126 A1	23-12-2009
		CN 102066304 A	18-05-2011
		EP 2303825 A1	06-04-2011
		US 2010004437 A1	07-01-2010
		US 2013158254 A1	20-06-2013
		US 2014235851 A1	21-08-2014
		WO 2009155297 A1	23-12-2009
