



## Finite Element and Experimental Study of Shunting in Resistance Spot Welding

Seyyedian Choobi, M.; Nielsen, C. V. ; Bay, N.

*Published in:*

Proceedings of the 11th International Seminar Numerical Analysis of Weldability

*Publication date:*

2015

*Document Version*

Peer reviewed version

[Link back to DTU Orbit](#)

*Citation (APA):*

Seyyedian Choobi, M., Nielsen, C. V., & Bay, N. (2015). Finite Element and Experimental Study of Shunting in Resistance Spot Welding. In *Proceedings of the 11th International Seminar Numerical Analysis of Weldability*

---

### General rights

Copyright and moral rights for the publications made accessible in the public portal are retained by the authors and/or other copyright owners and it is a condition of accessing publications that users recognise and abide by the legal requirements associated with these rights.

- Users may download and print one copy of any publication from the public portal for the purpose of private study or research.
- You may not further distribute the material or use it for any profit-making activity or commercial gain
- You may freely distribute the URL identifying the publication in the public portal

If you believe that this document breaches copyright please contact us providing details, and we will remove access to the work immediately and investigate your claim.

# FINITE ELEMENT AND EXPERIMENTAL STUDY OF SHUNTING IN RESISTANCE SPOT WELDING

M. SEYYEDIAN CHOABI, C. V. NIELSEN and N. BAY

*Department of Mechanical Engineering, Technical University of Denmark, Denmark*

## ABSTRACT

This research is focused on one of the problems frequently encountered in spot welding in industry. In many applications several spot welds are made close to each other. The spots made after the first spot may become smaller in size due to shunt effect. A numerical and experimental study has been conducted to investigate the effect of shunting on nugget size in spot welding of HSLA steel sheets. Different cases with different spacing between weld spots have been examined. The nugget sizes have been measured by metallographic examination and have been compared with 3D finite element simulations. The results of this study revealed that the shunt effect becomes negligible when the minimum weld spacing is about six times the electrode diameter. The results showed that the weld nugget diameter is more sensitive to shunt effect than the nugget height.

## INTRODUCTION

One of the problems commonly observed in spot welding is the reduction of nugget size after the first spot due to shunting. In many industrial applications such as automotive, several spot welds are made close to each other. In such cases, previously made welds may affect the new weld and part of the current aimed for the new weld passes through the neighbouring welds. This effect is called shunting and is known to affect weld quality and reduce weld strength. A schematic of shunting is shown in Figure 1.

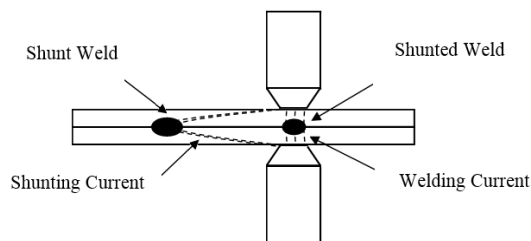

**Fig. 1** Schematic Representation of Shunting in Spot Welding.

Although shunting is a well-known phenomenon in spot welding, there is only a limited number of researches on this subject available in the literature. For example, Blair [1] investigated the effect of weld spacing, sheet width, sheet temperature and welding machine impedance on shunting in mild steel sheets. Nippes et al [2] studied the effect of weld spacing, weld material, electrode force and geometry on shunting in series spot welding of mild steel sheets. In a similar work, Ando et al. [3] examined the effect of plate thickness, plate width and electrode force on shunting in series spot welding. Howe [4] studied the effect of steel type, sheet thickness and coating on shunting. Johnson [5] investigated the effect of spacing between adjacent welds on shunting in spot welding of carbon steel sheets. Chang et al. [6] compared the percentage of current passing through the shunt and shunted welds for two cases with two different weld spacings. The results of all aforementioned studies proved that weld spacing affects shunting and increasing the weld spacing decreases the shunt effect. In a recent study, Li et al. [7] and Wang et al. [8] showed that shunting is multi-factorial and is affected by a combination of several parameters such as sheet material, thickness, coating, welding current, welding force and welding time.

This paper is a part of an extensive ongoing study investigating the effect of shunting on nugget size in spot welding of two- and three-layer automotive steel sheets. This work is focused on two-spot welding of two-layer sheets of HSLA340 steel. Several cases with different distances between spots have been examined and nugget sizes have been obtained numerically and experimentally.

## WELD PLANNING

The weld schedule specifications with optimal welding parameters including welding current, electrode force, welding time, squeeze time, hold time and number of pulses are predicted using SORPAS® 2D. The weld planning option of SORPAS® 2D provides weld schedule specifications based on sheets, electrodes and coating properties, welding machine type and user-defined weld quality. Weld quality was defined considering minimum weld nugget diameter of 4 mm based on the suggested criterion for minimum weld nugget  $4\sqrt{t}$  [9], where  $t$  is the sheet thickness in mm. Welding current was selected at 95% of the splash limit. The welding parameters obtained from weld planning are shown in Figure 2. However, the current and force obtained from weld planning were considered only as a starting point and their actual values were obtained by experiments.

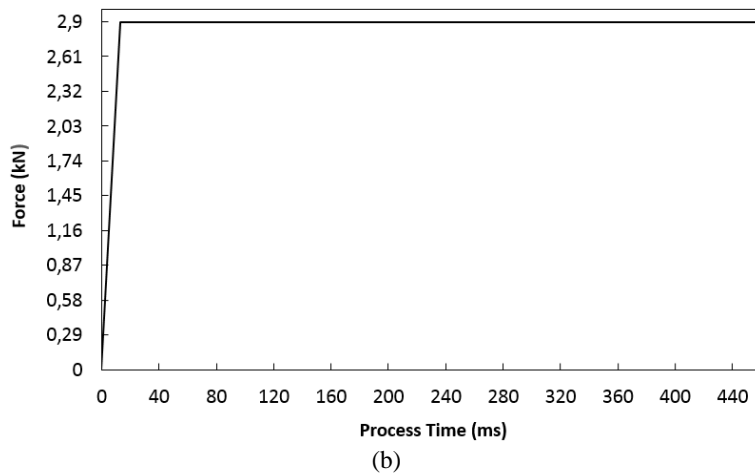
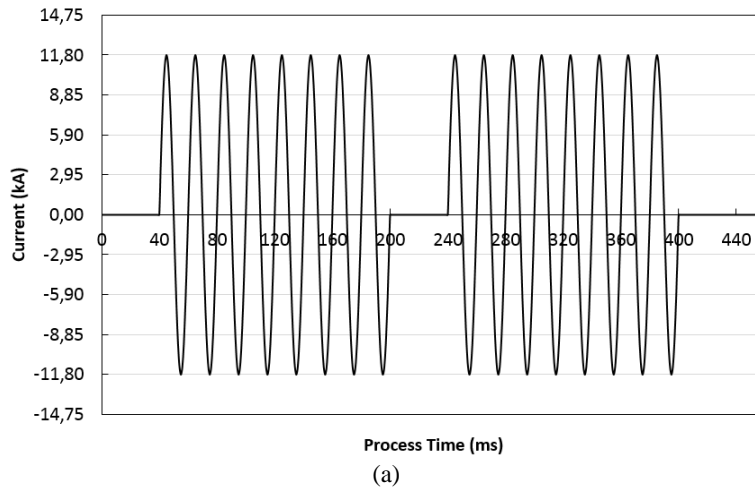
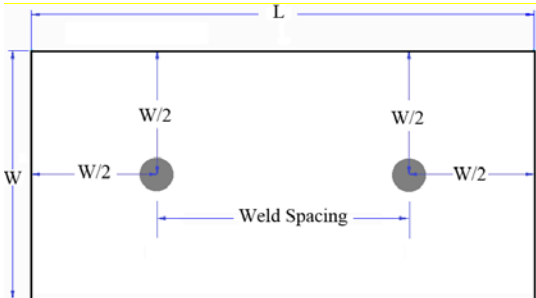

**Fig. 2** Optimal Welding Schedule Specifications (a) Welding Current, (b) Electrode Force.

### EXPERIMENTAL WORK

An experimental study was carried out to investigate the effect of shunting on nugget size in spot welding. For this purpose, a series of tests has been performed for two-spot welding of two sheets considering different spacing between the two welds. The sheets were cut into coupons with equal width but different lengths. The width of the coupons was 30 mm in all cases, while the length of the coupons was a function of distance between the two spots. The geometrical details of test coupons are shown in Figure 3, where  $L$  is the length of the test coupon and  $W$  is the width of the coupon. The first spot position was the same for all cases

while the second spot was located in a predetermined distance from the first spot. The distance between spots was chosen as a multiple of the electrode tip diameter ( $D$ ) and is presented in Table 1.



**Fig. 3** Geometrical Details of Test Coupons.

**Table 1** Weld Spacing in Different Cases.

Case	Weld Spacing
1	2D
2	3D
3	4D
4	5D
5	6D
6	7D
7	8D

The sheets were HSLA340 steel of thickness 1 mm zinc coated on both side with layers of thickness  $7\ \mu\text{m}$ . Welding was performed using a TECNA 8105 AC spot welding machine. The selected machine was able to deliver up to 20 kN force, 85 kA current with 50 Hz. Electrodes were of type B0 and of material CuCrZr alloy with electrode tip diameter of 6 mm. Spot locations were marked carefully on test coupons before welding to ensure the desired distance between the spots in each case. Welding parameters were taken from weld planning results and were the same for all cases. However, the actual current and force were measured using a Rogowski coil and a piezoelectric load cell.

The nugget sizes were measured by metallographic examination and shunt effects were investigated by comparing the nugget size of the second spot with the first one on the same coupon. Experiments were repeated three times for each case to ensure the repeatability of results. In total, 21 samples were spot welded and 42 nuggets were measured by metallographic examination.

## FINITE ELEMENT SIMULATION

Three-dimensional finite element simulations were performed using SORPAS® 3D. Because of symmetry only half of the physical model was considered in 3D simulation. Due to high temperature gradients in and around the weld spots, a relatively fine mesh was created in these regions. Element sizes were increased in the regions far from the spot weld locations. Coating of thickness 0.007 mm was considered on each side of the sheets. Contact between the electrode-sheet and sheet-sheet surfaces was modelled by contact elements of thickness 0.01 mm and 0.05 mm, respectively. The finite element model is shown in Figure 4.

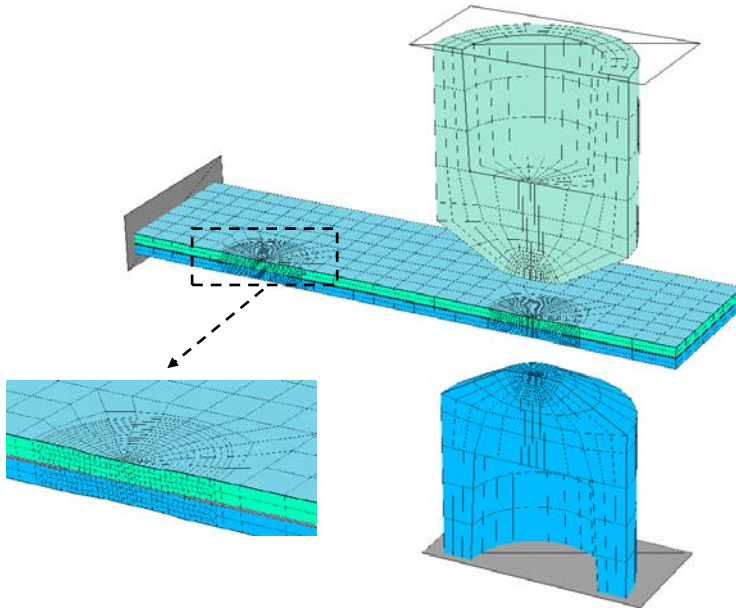

**Fig. 4** 3D Finite Element Model.

Finite element simulation of spot welding was performed by a coupled electro-thermo-mechanical analysis [10, 11]. The simulation of spot welding in general is composed of four FE models including an electrical, a thermal, a metallurgical and a mechanical model. The distribution of voltage, current and heat generation in materials and electrodes are calculated in the electrical model. The temperature distribution and heat transfer are computed in the thermal model. The phase transformations are calculated in the metallurgical model considering latent heat and temperature-dependent material properties. The stress and strain distributions, the deformation of materials and nugget growth are computed in the mechanical model. Current and force were considered as electrical and mechanical loads in electrical and mechanical analyses, respectively. The current and force data for each simulation were taken from the experiments. The physical and mechanical material

properties were considered temperature-dependent and were taken from SORPAS® database. Squeeze time, hold time and off time were considered 2, 6 and 6 cycles, respectively.

## RESULTS AND DISCUSSION

The results of finite element simulations for the first and second nugget diameters are presented in Table 2. The results show that increasing the distance between the spots decreases the shunt effect. The maximum shunt effect is related to the case where the distance between the spots is twice the electrode diameter. The shunt effect becomes negligible when the distance between the spots is seven times the electrode diameter. The general trend for all the cases is that the second nugget diameter is smaller than the first one. However, for the cases 6 and 7 the second nugget diameter has become 0.37% and 0.18% bigger in comparison to the first nugget diameter. The reason for this is that the magnitude of the measured current and force for the second nugget in these cases were 2.5 % and 0.6% higher in comparison to the first nugget current and force. These changes occurred due to machine variations.

**Table 2** Comparison of 1<sup>st</sup> and 2<sup>nd</sup> Nugget Diameter Obtained from FE Simulations.

Case	Weld Spacing (mm)	1 <sup>st</sup> Nugget Diameter (mm)	2 <sup>nd</sup> Nugget Diameter (mm)	Nugget Diameter Reduction (%)
1	12	5.75	5.21	9.39
2	18	5.68	5.29	6.86
3	24	5.57	5.31	4.66
4	30	5.55	5.38	3.06
5	36	5.57	5.36	3.77
6	42	5.31	5.33	- 0.37
7	48	5.31	5.32	- 0.18

The results of metallographic measurements for the first and second nuggets are shown in Figure 5 and are presented in Table 3. The experimental results follow the same trend as finite element results. The metallography of different cases are presented in Table 4.

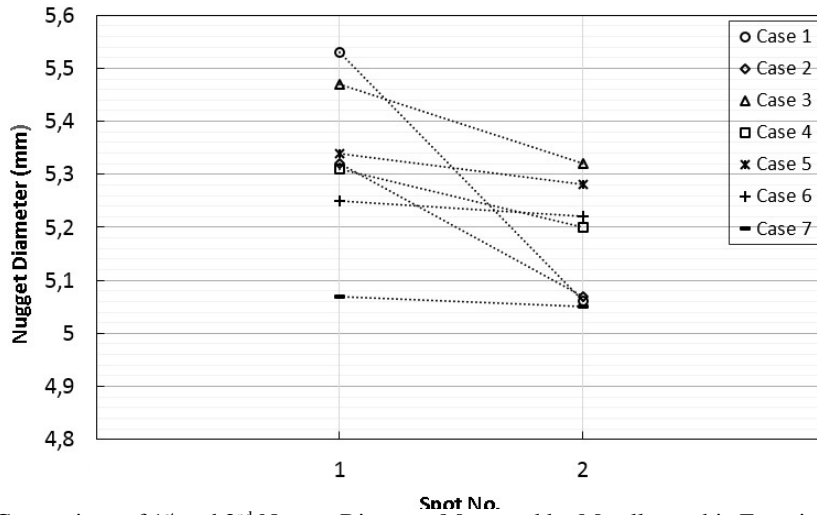

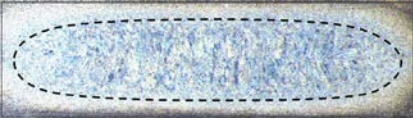
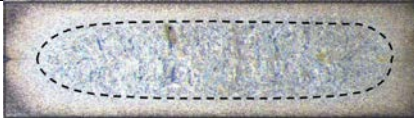

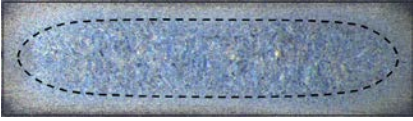
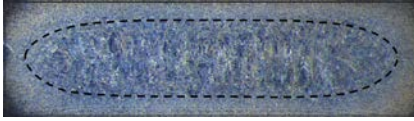
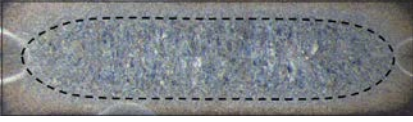
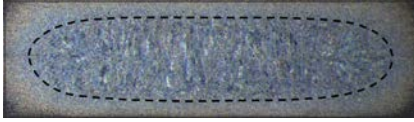
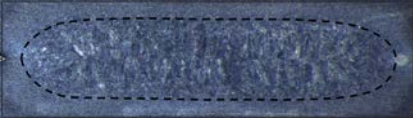
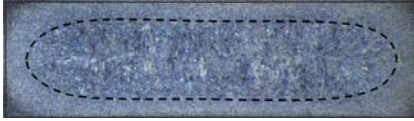
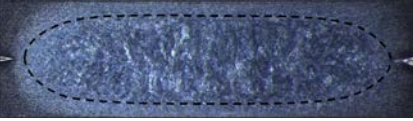
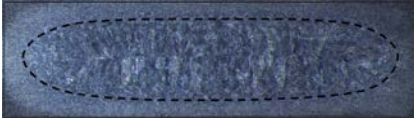
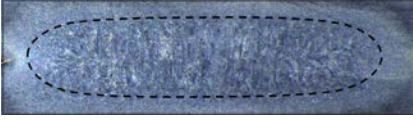

**Fig. 5** Comparison of 1<sup>st</sup> and 2<sup>nd</sup> Nugget Diameter Measured by Metallographic Examination.

**Table 3** Comparison of 1<sup>st</sup> and 2<sup>nd</sup> Nugget Diameter Obtained from Experimental Measurements.

Case	Weld Spacing (mm)	1 <sup>st</sup> Nugget Diameter (mm)	2 <sup>nd</sup> Nugget Diameter (mm)	Nugget Diameter Reduction (%)
1	12	5.53	5.06	8.49
2	18	5.32	5.07	4.69
3	24	5.47	5.32	2.74
4	30	5.31	5.20	2.07
5	36	5.34	5.28	1.12
6	42	5.25	5.22	0.57
7	48	5.07	5.05	0.39

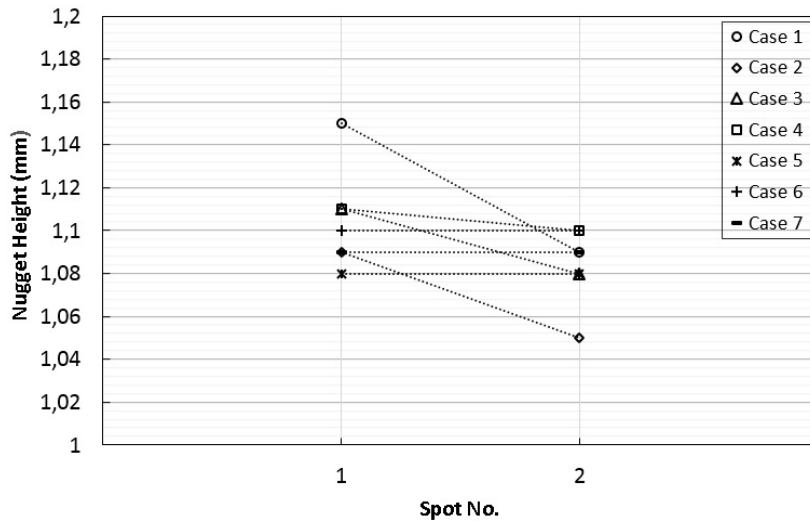

**Table 4** Metallography of 1<sup>st</sup> and 2<sup>nd</sup> Nugget for Different Cases.

Case	1 <sup>st</sup> Nugget	2 <sup>nd</sup> Nugget
1		
2		
3		
4		
5		
6		
7		

1 mm

The measured nugget height in different cases are shown in Figure 6 and are presented in Table 5. As the results show, increasing the distance between the spots decreases the nugget height difference and the second nugget height becomes closer to the first one. The results also reveal that the nugget height is less sensitive to shunt effect than the nugget diameter.

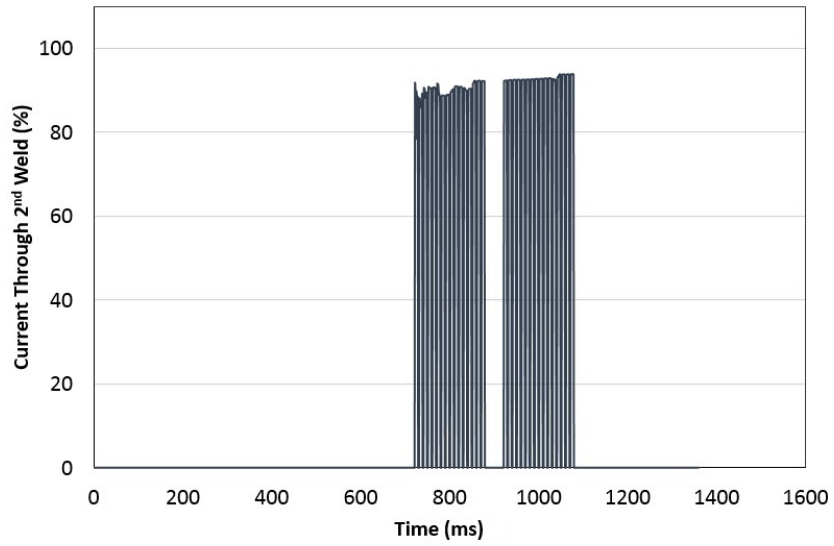
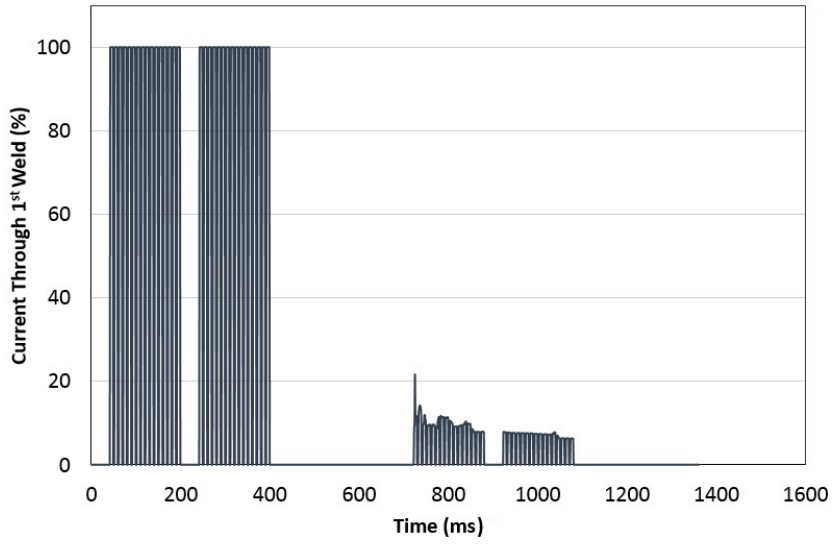

**Fig. 6** Comparison of 1<sup>st</sup> and 2<sup>nd</sup> Nugget Height Measured by Metallographic Examination.

**Table 5** Comparison of 1<sup>st</sup> and 2<sup>nd</sup> Nugget Height Obtained from Experimental Measurements.

Case	Weld Spacing (mm)	1 <sup>st</sup> Nugget Height (mm)	2 <sup>nd</sup> Nugget Height (mm)	Nugget Height Reduction (%)
1	12	1.15	1.09	5.21
2	18	1.09	1.05	3.66
3	24	1.11	1.08	2.70
4	30	1.11	1.10	0.9
5	36	1.08	1.08	0
6	42	1.10	1.10	0
7	48	1.09	1.09	0

Figure 7 shows the percentage of welding current passing through the first and second spot welds during welding. The results show that in all the cases a part of the current passes through the first spot during welding of the second spot. Comparison of the percentage of current passing through the spots in three cases (1, 4 and 7) shows that in the first case where the weld spacing is the smallest higher percentage of current passes through the first spot in comparison to other cases. The percentage of current passing through the first spot decreases with the increase of distance between the two spots. The current drop due to shunt effect results in nugget size reduction in the second spot.



(a)

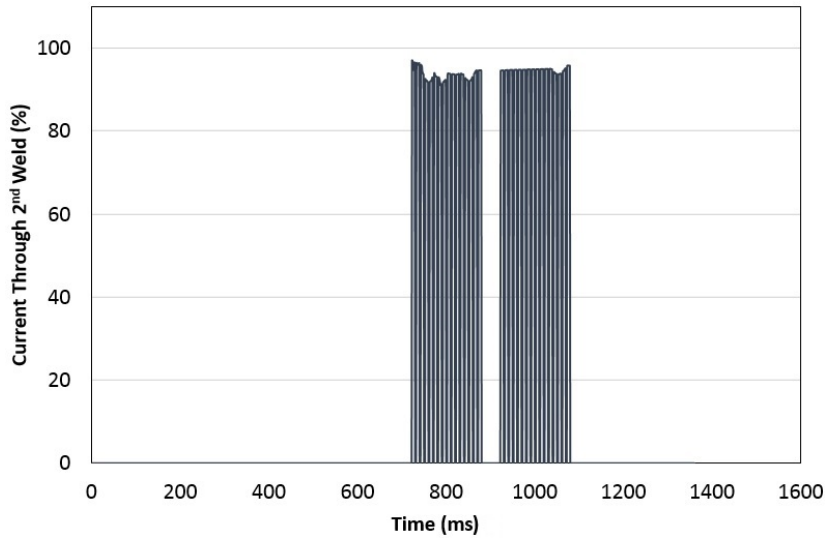
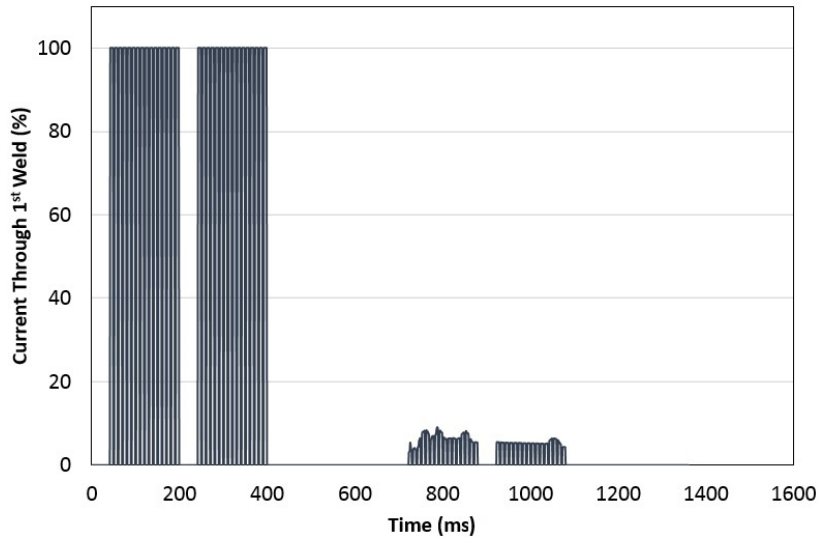

(b)

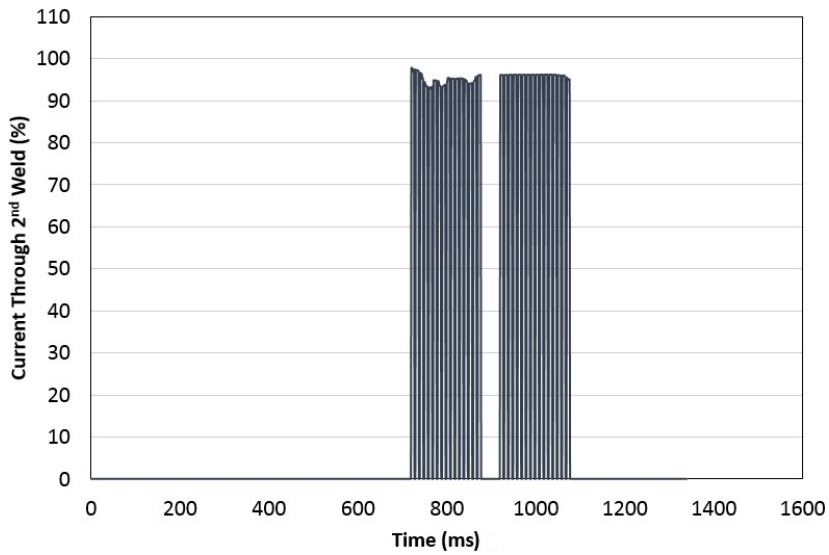
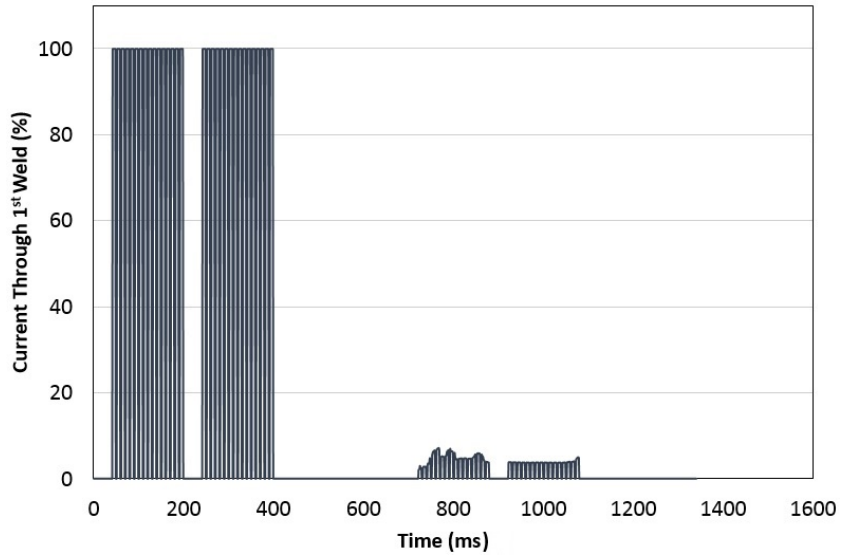

(c)

**Fig. 7** Current Passing Through the 1<sup>st</sup> and 2<sup>nd</sup> Spot Welds in: (a) Cases 1, (b) Case 4 and (c) Case 7.

## CONCLUSION

In this paper, the effect of shunting on nugget size in spot welding of two sheets of HSLA340 steel have been investigated numerically and experimentally. The nugget sizes have been calculated by 3D FE simulations and have been compared with the metallographic examinations. The experimental results verified the numerical model. The results of this study revealed that the shunt effect becomes negligible when the distance between the spots is at least six times the electrode diameter. The results also revealed that weld nugget diameter is more sensitive to shunt effect than the nugget height.

## REFERENCES

- [1] R. H. BLAIR: 'Shunt Circuit Impedance in Spot Welding 1/8-, 1/4-, 1/2-in. Mild Steel', *Welding Journal*, Vol. 26, No. 10, pp. 843-848, 1947.
- [2] E. F. NIPPES, W. F. SAVAGE and S. M. ROBELOTTO: 'Measurement of Shunting Currents in Series Spot Welding 0.036-in. Steel', *Welding Journal*, Vol. 34, No. 6, pp. 618-624, 1955.
- [3] K. ANDO, J. NISHIKAWA and T. OKUDA: 'A Study of Shunting Current and its Effect on Tensile Shear Strength in Series Spot Welding', *Journal of the Japan Welding Society*, Vol. 34, No. 5, pp. 501-510, 1965.
- [4] P. HOWE: 'Spot Weld Spacing Effect on Weld Button Size', *Sheet Metal Welding Conference VI*, Paper C03, AWS Detroit Section, 1994.
- [5] I. W. JOHNSON: 'Spot Welding of Carbon Steel', *Welding Journal*, Vol. 39, No. 1, pp. 89-96, 1960.
- [6] H. S. CHANG, H. S. CHO: 'A Study on the Shunt Effect in Resistance Spot Welding', *Welding Journal*, pp. 308-318, 1990.
- [7] Y. B. LI, B. WANG, Q. SHEN, M. LOU and H. ZHANG: 'Shunting Effect in Resistance Spot Welding Steels – Part 2: Theoretical Analysis', *Welding Journal*, Vol. 92, pp. 231-238, 2013.
- [8] B. WANG, M. LOU, Q. SHEN, Y. B. LI and H. ZHANG: 'Shunting Effect in Resistance Spot Welding Steels – Part 1: Experimental Study', *Welding Journal*, Vol. 92, pp. 182-189, 2013.
- [9] S. WESTGATE: 'Settings for Resistance Spot Welding of Steels – Practical Guidelines', *TWI Ltd Report*, 2011.
- [10] C. V. NIELSEN, W. ZHANG, W. PERRET, P. A. F. MARTINS and N. BAY: 'Three-Dimensional Simulations of Resistance Spot Welding', *Proc IMechE Part D*, Journal of Automobile Engineering, Vol. 229, No. 7, pp. 885-897, 2015.
- [11] E. FEULVARCH, V. ROBIN and J. M. BERGHEAU: 'Resistance Spot Welding Simulation: A General Finite Element Formulation of Electrothermal Contact Conditions', *Journal of Materials Processing Technology*, Vol. 153-154, pp. 436-441, 2004.