



## Comprehensive Congestion Management for Distribution Networks based on Dynamic Tariff, Reconfiguration and Re-profiling Product

Shen, Feifan; Huang, Shaojun; Wu, Qiuwei; Repo, Sami; Xu, Yan; Østergaard, Jacob

*Published in:*

I E E Transactions on Smart Grid

*Link to article, DOI:*

[10.1109/TSG.2018.2868755](https://doi.org/10.1109/TSG.2018.2868755)

*Publication date:*

2019

*Document Version*

Peer reviewed version

[Link back to DTU Orbit](#)

*Citation (APA):*

Shen, F., Huang, S., Wu, Q., Repo, S., Xu, Y., & Østergaard, J. (Accepted/In press). Comprehensive Congestion Management for Distribution Networks based on Dynamic Tariff, Reconfiguration and Re-profiling Product. *I E E Transactions on Smart Grid*. <https://doi.org/10.1109/TSG.2018.2868755>

---

### General rights

Copyright and moral rights for the publications made accessible in the public portal are retained by the authors and/or other copyright owners and it is a condition of accessing publications that users recognise and abide by the legal requirements associated with these rights.

- Users may download and print one copy of any publication from the public portal for the purpose of private study or research.
- You may not further distribute the material or use it for any profit-making activity or commercial gain
- You may freely distribute the URL identifying the publication in the public portal

If you believe that this document breaches copyright please contact us providing details, and we will remove access to the work immediately and investigate your claim.

# Comprehensive Congestion Management for Distribution Networks based on Dynamic Tariff, Reconfiguration and Re-profiling Product

Feifan Shen, Shaojun Huang, *Member, IEEE*, Qiuwei Wu, *Senior Member, IEEE*, Sami Repo, *Member, IEEE*, Yan Xu, *Member, IEEE*, and Jacob Østergaard, *Senior Member, IEEE*

**Abstract**— This paper proposes a comprehensive scheme for day-ahead congestion management of distribution networks with high penetration of distributed energy resources (DERs). In the proposed scheme, the dynamic tariff (DT), network reconfiguration and re-profiling products are integrated, which combines the advantages of these methods. In addition, the previously proposed DT model is relaxed in order to handle possible infeasibility of the DT problem and set a limit for the DT. With the utilization of the flexibilities from various types of DERs and the advantages of the three congestion management methods, the proposed comprehensive scheme can solve the congestion more effectively and at the same time ensures that the congestion management prices are within an acceptable level. Three case studies were conducted with the modified Roy Billinton Test System (RBTS) to validate the effectiveness and advantages of the proposed comprehensive scheme.

**Index Terms**— Congestion management, distributed energy resources (DER), dynamic tariff (DT), network reconfiguration (NR), re-profiling products.

## NOMENCLATURE

<i>Sets</i>	
$N_t$	Set of day-ahead planning periods
$\bar{N}_t$	Subset of $N_t$ for market agent
$N_B$	Set of aggregators
$N_L$	Set of lines of the meshed network
$N_s$	Set of lines with sectionalizing switches

The work was supported by the DTU-NTU double PhD project of the Smart City joint program.

F. Shen, J. Østergaard are with Centre for Electric Power and Energy, Department of Electrical Engineering, Technical University of Denmark, Kgs. Lyngby, DK 2800 (e-mail: [fshen@elektro.dtu.dk](mailto:fshen@elektro.dtu.dk), [joe@elektro.dtu.dk](mailto:joe@elektro.dtu.dk)).

S. Huang is with Centre for Energy Informatics, University of Southern Denmark, 5230 Odense M, Denmark (e-mail: [shahu@mmmi.sdu.dk](mailto:shahu@mmmi.sdu.dk)).

Q. Wu is with Centre for Electric Power and Energy, Department of Electrical Engineering, Technical University of Denmark, Kgs. Lyngby, DK 2800 and Harvard China Project, School of Engineering and Applied Sciences, Harvard University, 29 Oxford Street, Cambridge, 02138 MA, USA (e-mail: [qw@elektro.dtu.dk](mailto:qw@elektro.dtu.dk), [qiuwu@seas.harvard.edu](mailto:qiuwu@seas.harvard.edu)).

S. Repo is with Department of Electrical Engineering, Tampere University of Technology, Tampere, Finland (e-mail: [sami.repo@tut.fi](mailto:sami.repo@tut.fi)).

Y. Xu are with School of Electrical and Electronic Engineering, Nanyang Technological University, 50 Nanyang Avenue, Singapore, 639798 (e-mail: [xyuan@ntu.edu.sg](mailto:xyuan@ntu.edu.sg)).

Corresponding Author: Q. Wu (e-mail: [qw@elektro.dtu.dk](mailto:qw@elektro.dtu.dk), [qiuwu@seas.harvard.edu](mailto:qiuwu@seas.harvard.edu)).

$N_d$	Set of electric nodes except for substation
<i>Parameters</i>	
$A_{i,t,t} \in R^{m_i \times m_i}$	Power to temperature matrix
$B_{i,t} \in R^{m_i \times m_i}$	Matrix of the price sensitivity coefficient
$C \in R^{n_w \times n_s}$	Reduced incidence matrix
$D_t \in R^{n_l \times n_d}$	Power transfer distribution factor (PTDF) of the network in the day-ahead planning period $t$
$E_i \in R^{n_d \times m_i}$	Customer to load bus mapping matrix
$G \in R^{n_d \times n_l}$	Reduced incidence matrix
$H_t \in R^{n_d \times n_l}$	Voltage incident matrix of the network in the day-ahead planning period $t$
$K_{i,t}^{a,\min} \in R^{m_i}$	Lower house inside temperature limit
$K_{i,t}^{a,\max} \in R^{m_i}$	Upper house inside temperature limit
$K_{i,0}^a \in R^{m_i}$	Initial house inside temperature
$P_t^{(i,g)}$	Number of offered flexibility products of the aggregator $i$ at node $g$ in the day-ahead planning period $t$
$R \in R^{n_l \times n_l}$	Diagonal resistance matrix of the meshed network
$V_t^{\text{sqr},\min} \in R^{n_d}$	Minimum of square of the voltage magnitude
$V_t^{\text{sqr},\max} \in R^{n_d}$	Maximum of square of the voltage magnitude
$V_t^{b,\text{sqr}} \in R^{n_d}$	Square of nominal voltage magnitude at substation.
$X \in R^{n_l \times n_l}$	Diagonal reactance matrix of the meshed network
$M$	A very big number
$c_t$	Base price
$d_{i,t} \in R^{m_i}$	Discharge power of EV due to driving
$e_i^{\min} \in R^{m_i}$	Lower limit of the state of charge (SOC) level
$e_i^{\max} \in R^{m_i}$	Upper limit of the SOC level
$e_{i,0} \in R^{m_i}$	Initial SOC level
$f_t^{\max} \in R^{n_l}$	Line loading limit

$l_t^{loss}$	Cost coefficient of the line loss
$m_i$	Number of customers of aggregator $i$
$n_*$	Cardinality of $N_*$ , applicable to $N_d, N_L, N_S,$ $N_w$
$n_v$	Total vertexes of graph
$p_{i,t}^{\min} \in R^{m_i}$	Lower charging power limit of EV
$p_{i,t}^{\max} \in R^{m_i}$	Upper charging power limit of EV
$\tilde{p}_{i,t}^{\min} \in R^{m_i}$	Lower charging power limit of HP
$\tilde{p}_{i,t}^{\max} \in R^{m_i}$	Upper charging power limit of HP
$p_t^c \in R^{n_d}$	Active demand at each node
$p_t^f$	Price of the flexibility product
$p_t^g \in R^{n_d}$	Power injection of distributed generator
$q_t^c \in R^{n_d}$	Reactive demand at each node
$w_t^j / w_t^v$	Penalty coefficients
$\pi_t^f$	Volume of the flexibility product
<i>Continuous variables</i>	
$F_t^p \in R^{n_L}$	Active power flow of line
$F_t^q \in R^{n_L}$	Reactive power flow of line
$K_t \in R^{n_L}$	Fictitious active power flow of line
$V_t^{sqr} \in R^{n_d}$	Square of the voltage magnitude
$\Delta V_t^{sqr} \in R^{n_L}$	Difference of square of voltage of line
$p_{i,t} \in R^{m_i}$	Charging power of EVs of aggregator $i$
$\tilde{p}_{i,t} \in R^{m_i}$	Power consumption of HPs of aggregators $i$
$\bar{p}_t^{gen} \in R^{n_d}$	Power injection of distributed generator after providing flexibility products
$\bar{p}_t^{load} \in R^{n_d}$	Active demand at each node after providing flexibility products
$\alpha_t^l \in R^{n_L}$	Auxiliary variable of the line loading limit
$\alpha_t^v \in R^{n_d}$	Auxiliary variable of the voltage magnitude limit
$s_{t,jk}$	Auxiliary variable of line $jk$
<i>Binary variables</i>	
$x_{t,jk}$	Status of sectionalizing switch $jk$ in the day-ahead planning period $t$
$z_t^{pur}$	Purchase status of flexibility product

## I. INTRODUCTION

**D**UE to the increasing environmental issues and energy supply security concerns, the traditional distribution network is in the transition from a passive network to an active network with large-scale integrations of distributed energy resources (DERs) [1]. Consequently, high penetration of DERs will pose many challenges to the distribution network operators (DSOs), such as congestion management caused by overloading of feeders. In addition to conventional congestion

management methods, such as grid reinforcement [2] and network reconfiguration [3]-[4], different types of market-based methods have been proposed to mitigate congestion.

The distribution locational marginal pricing (DLMP) scheme was developed in [5]-[7] to incorporate DERs units, such as distributed generators (DGs) and distributed energy storages, into day-ahead distribution-level market clearing respecting network constraints. In addition, recent studies proposed several market-based demand response programs (DRPs), which influence flexible demands to change their consumption patterns for the purpose of congestion management. Market-based DRPs can be roughly categorized into two types, namely price-based DRPs and incentive-based DRPs.

In the price-based DRPs, flexible demands respond to the changes of electricity prices by adjusting their consumption profiles. In the dynamic tariff (DT) method proposed in [8]-[10], the DSO publishes DTs to the aggregators, which leads to higher final prices (spot prices plus tariffs) at congested hours. Thus, the aggregators will shift flexible demands to off-peak period to minimize their energy cost. The work in [11] developed the dynamic subsidy method that shares a similar idea with the DT method. In [12], the congestion was solved similarly to the DT method through the distribution grid capacity market (DGCM) scheme in which iteration processes between the DSO and the aggregators are required to reach optimal tariffs.

In the incentive-based DRPs, one main type is to build a flexibility market in which the DSO can procure flexibility products to handle congestion. The studies in [13]-[14] established a day-ahead flexibility market to trade flexibility products. The work in [15] defined two kinds of flexibility products, namely scheduled re-profiling products (SRPs) and conditional re-profiling products (CRPs). The work in [16] designed a hierarchy congestion management scheme that uses SRPs and CRPs to mitigate congestion. Moreover, [17] studied a decision model to optimize the total cost charged by the DSO for utilizing flexibility products.

Although the above mentioned market-based methods are effective in congestion management, there are some issues when only one method is implemented. For example, the DT method, as a widely used price-based DRP, has some drawbacks. The key feature of the DT method is that the optimal energy plans made at the DSO side can be realized at the aggregator side through the DTs. The effectiveness of the DT method depends on the calculation of DTs. However, when severe congestion occurs, due to the physical limits of the networks, the optimization at the DSO side may be infeasible and DTs cannot be obtained, resulting in failure of the DT method. In addition, because the congestion management price is unlimited in theory, customers may face very high or even unacceptable DTs in the severe congestion situation. Therefore, in order to resolve the above issues, a relaxed reconfiguration based DT optimization model is proposed in this paper, which can ensure a feasible solution in severe congestion situations and limit the DTs to be below a preset limit.

In addition, integrating different congestion management

methods is a promising way to overcome the drawbacks when a single method is used and achieve a better solution for congestion management. Recent studies proposed to combine the NR with the price-based DRPs or incentive-based DRPs. The authors in [18] integrated the network reconfiguration with DGCM scheme. A reconfiguration based DT optimization was proposed in [19] to incorporate the network reconfiguration method into the DT method. A hierarchical control scheme was developed in [16], in which the tertiary control (TC) layer combines the network reconfiguration method and flexibility products (SRPs/CRPs) to solve the congestion. In addition, a direct control method was used in [20], namely active power curtailment, to complement market-based methods. However, integrating the price-based DRPs (the DT method) and incentive-based DRPs (re-profiling products) for congestion management has not been studied. Advantages of this integration are summarized as follows. Firstly, since the DSO can procure flexibility products to solve part of congestion, it is not necessary for the DSO to impose very high DTs in order to resolve congestion. Therefore, the customers will not face very high final prices. Secondly, the DSO purchases less flexibility products in the flexibility market, as the DT method can help mitigate congestion partially. Finally, the DSO and aggregators can share the responsibility of congestion management because they share the congestion management cost. Therefore, a comprehensive scheme is proposed in this paper for congestion management based on the DT, network reconfiguration and re-profiling product, which represent the price-based method, direct control method and incentive-based method, respectively.

The contributions of this paper are summarized as follows: 1) propose a relaxed reconfiguration based DT optimization model that can find a feasible solution when the original unrelaxed DT model is infeasible and limit DTs to be below a preset limit; 2) consider both the line loss reduction and voltage limits in the proposed DT optimization model; 3) propose a comprehensive scheme to combine the price-based DRP, direct control method and incentive-based DRP to effectively resolve congestion.

The paper is organized as follows. Section II describes the DT, network reconfiguration, re-profiling product and the framework of the comprehensive scheme. The mathematic models and algorithm of the comprehensive scheme are presented in Section III. In Section IV, case studies are given and discussed, followed by conclusions.

## II. COMPREHENSIVE SCHEME BASED ON DYNAMIC TARIFF, NETWORK RECONFIGURATION AND RE-PROFILING PRODUCT

This section first describes the DT, network reconfiguration and re-profiling products for solving congestion. Secondly, a comprehensive congestion management scheme based on the DT, network reconfiguration and re-profiling products is illustrated.

### A. Dynamic Tariff Method

The DT method is a decentralized market-based congestion management method. According to [9], the basic procedures of

using DTs to solve congestion are as follows. Firstly, the DSO predicts the energy prices of the spot market. The DSO also obtains grid model and flexible demands data, such as consumption requirements and availability of the flexible demands (like electric vehicles (EVs)), from the aggregators or by its own prediction. Secondly, the DSO conducts an OPF study considering network constraints to obtain DTs, and DTs are sent to the aggregators. Thirdly, after receiving DTs, the aggregators implement their own optimizations based on the predicted spot prices and DTs. Finally, the aggregators submit their optimal energy bids to the day-ahead energy market.

The DT method is carried out before the day-ahead market clears. In this method, the DSO is responsible for sending DTs to the aggregators, and the aggregators manage flexible demands according to the final prices. Thus, the DSO is the only responsible actor for congestion management.

### B. Network Reconfiguration

The network reconfiguration is a direct congestion management method directly implemented by the DSO in different time frames, such as day-ahead and real time. The reconfiguration is to change the topology of the network to realize certain objectives, such as reducing line losses and mitigating congestion. By opening some normally closed switches and closing some normally open switches, demand consumptions among feeders can be shifted to alleviate congestion. In addition, distribution networks are usually designed as weakly meshed structures, but they operate with radial topology due to security reasons. The large number of discrete switching variables and radial condition constraints lead to a highly complex mixed integer nonlinear programming (MINLP) problem. A mixed integer linear programming (MILP) problem was formulated in [19] to incorporate the DT method and network reconfiguration to solve congestion. The radial constraints were mathematically imposed and the problem was solved by mixed integer programming. A heuristic method was used in [16] to solve the MINLP problem, and the radial constraints were imposed by the genetic algorithm.

### C. Flexibility Products

In existing market-based congestion management methods, one promising approach is to establish a day-ahead flexibility market, in which the DSO procures flexibility products to alleviate congestion. Different from the DT method, the aggregators in this method gather flexibilities from flexible demands and trade them in the flexibility market. A parallel architecture of the day-ahead flexibility market and existing energy market was built in [13], in which these two markets coexist in time and space. After the day-ahead energy market clears, the DSO checks if the proposed energy schedules lead to congestion. If congestion exists, the DSO will purchase flexibility products from the day-ahead flexibility market to solve it. In the flexibility market, the aggregators provide different types of flexibility products to satisfy various needs of the DSO. Two types of flexibility products (SRPs/CRPs) were proposed in [15], the SRP means that the aggregators have the obligation to produce/consume assigned power during an

assigned period while CRP means that the aggregators must have the capacity of changing assigned power at a designated period. In order to minimize the cost of the DSO purchasing these flexibility products, the market agent concept was proposed in [16]. The market agent aims to minimize the cost of the DSO to purchase flexibility products in the flexibility market.

#### D. Framework of the Comprehensive Scheme

In this subsection, the integration of the DT, network reconfiguration and re-profiling products and the framework of the comprehensive scheme are described. As mentioned previously, these methods are implemented in the day-ahead time frame. The DT method is implemented before the energy bidding process while the re-profiling product is used after the proposed energy schedules are formulated. Thus, it is feasible to combine the DT method and the procurement of re-profiling products in sequence. Because it is preferred to solve congestion before the energy bidding process, the network reconfiguration is integrated into the DT framework. The combined optimization of the flexible demands and network topology can achieve the best solution for congestion management before the energy bidding process. Based on the above analyses, the proposed scheme consists of two steps: firstly, the DT and network reconfiguration are integrated to mitigate congestion before the energy bidding process; secondly, the re-profiling products are utilized to mitigate remaining unsolved congestion after the energy bidding process.

In the proposed scheme, the aggregators act as mediators among customers, the DSO and markets. Although the aggregators have different roles in the DT method and flexibility market, a generic aggregator concept was proposed in [21] to combine them. The generic aggregators have the following roles: 1) submit energy bids and purchase energy in the day-ahead market on behalf of flexible demand users, such as EV and HP users; 2) mobilize flexible demands and create optimal energy plans for them; 3) gather flexibilities from flexible demands and bid flexibility products in the flexibility market; 4) manage flexible demands and implement flexibility services. In the proposed scheme, each customer is assigned to an aggregator by a contract and customers can choose to be only involved in either DTs or the flexibility market. It is also assumed that each aggregator only has contracts with a small portion of customers in each load bus so that aggregators do not have market power.

The framework of the comprehensive scheme is illustrated in Fig. 1. All functionalities of each player (the DSO, aggregator, and market) are illustrated in separate blocks. According to the framework, the detailed procedures of using the comprehensive scheme to solve congestion in the day-ahead time frame are described as follows. Firstly, the DSO predicts and acquires all necessary data. The DSO determines the optimal network topology schedule and DTs, and then publishes DTs to the aggregators. After receiving DTs, the aggregators manage those flexible demands that are willing to respond to the DTs based on the final prices, and submit the energy bids to the

day-ahead energy market. At the same time, the aggregators gather flexibilities from the flexible demands that are willing to provide flexibilities, and then offer flexibility bids to the day-ahead flexibility market. After the energy bidding process, the DSO validates if the proposed energy schedules lead to congestion. If congestion does not exist, the day-ahead energy market and day-ahead flexibility market are closed. Otherwise, the DSO will request the market agent to purchase flexibility products in the flexibility market to alleviate congestion. After the flexibility market clears, the aggregators will be informed about the accepted flexibility products. As such, a final energy schedule is determined.

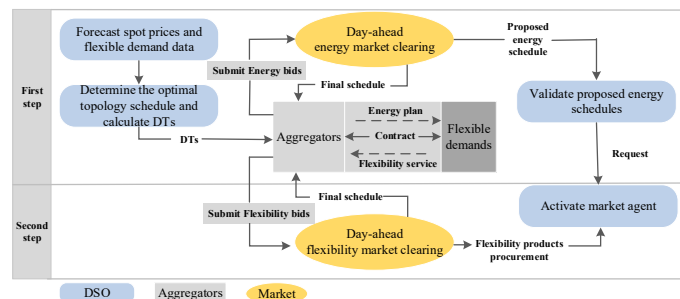

Fig. 1. Framework of the comprehensive scheme

### III. MATHEMATIC MODELS AND ALGORITHM OF THE COMPREHENSIVE SCHEME

As described in Section II-D, the comprehensive scheme alleviates congestion with two steps, in which the DT and network reconfiguration are integrated in the first step and the re-profiling products are used in the second step. This section presents mathematical models in the two steps and the algorithm of the comprehensive scheme. In the study, it is assumed that a part of EVs and heat pumps (HPs) respond to DTs while the rest of them and onsite DGs provide flexibility products.

#### A. Relaxed Reconfiguration Based DT Model in the First Step

As mentioned before, the original DT method in [9] and [19] has some limitations. For example, the customers may face very high final prices or the method may fail due to the infeasibility of the DSO optimization. In order to resolve the above issues, a relaxed reconfiguration based DT model that can resolve the infeasible issue and limit the maximum DT is proposed.

##### 1) Relaxed reconfiguration based DSO optimization

The relaxed reconfiguration based DSO optimization is used to determine the optimal topology schedule of the network and DTs that ensure the energy planning at the aggregator side converges with the planning at the DSO side. Compared with the DSO optimizations in [9] and [19], the line loss reduction and voltage limits are included, and the auxiliary variables are introduced to relax the line loading constraints and the voltage magnitude constraints. These auxiliary variables ensure that the relaxed reconfiguration based DSO optimization has a feasible solution and DTs can be obtained. Moreover, the penalty terms relating to these auxiliary variables in the objective function enable the DSO to decide how much the line loading constraints and voltage constraints should be relaxed. The

relaxed reconfiguration based DSO optimization is formulated as the following MILP problem.

$$\min \sum_{i \in N_T} \left[ \sum_{i \in N_B} \left( p_{i,t}^T B_{i,t} p_{i,t} + (c_i 1)^T p_{i,t} + \tilde{p}_{i,t}^T B_{i,t} \tilde{p}_{i,t} + (c_i 1)^T \tilde{p}_{i,t} \right) \right. \\ \left. \left( w_i^l 1 \right)^T \alpha_i^l + \left( w_i^v 1 \right)^T \alpha_i^v + l_i^{\text{loss}} \left( F_i^p \right)^T R F_i^p \right] \quad (1)$$

subject to

$$G F_i^p = p_i^c - p_i^g + \sum_{i \in N_B} E_i \left( p_{i,t} + \tilde{p}_{i,t} \right), \forall t \in N_T \quad (2)$$

$$G F_i^q = q_i^c, \forall t \in N_T \quad (3)$$

$$\left| F_i^p \right| \leq f_i^{\text{max}} + \alpha_i^l, \forall t \in N_T, \left( \pi_i^-, \pi_i^+ \right) \quad (4)$$

$$\left| \left\{ F_i^p \right\}_{jk} \right| \leq M x_{t,jk}, \forall jk \in N_s, t \in N_T \quad (5)$$

$$\left| \left\{ F_i^q \right\}_{jk} \right| \leq M x_{t,jk}, \forall jk \in N_s, t \in N_T \quad (6)$$

$$\left\{ V_i^{\text{sqr}} \right\}_j - \left\{ V_i^{\text{sqr}} \right\}_k = 2 \left( \left\{ R F_i^p \right\}_{jk} + \left\{ X F_i^q \right\}_{jk} \right) \\ \forall jk \in N_L \setminus N_s, t \in N_T \quad (7)$$

$$\left\{ V_i^{\text{sqr}} \right\}_j - \left\{ V_i^{\text{sqr}} \right\}_k = 2 \left( \left\{ R F_i^p \right\}_{jk} + \left\{ X F_i^q \right\}_{jk} \right) + s_{t,jk}, \\ \forall jk \in N_s, t \in N_T \quad (8)$$

$$\left| s_{t,jk} \right| \leq M \left( 1 - x_{t,jk} \right), \forall jk \in N_s, t \in N_T \quad (9)$$

$$V_i^{\text{sqr}, \min} - \alpha_i^v \leq V_i^{\text{sqr}} \leq V_i^{\text{sqr}, \max} + \alpha_i^v, \forall t \in N_T, \left( \xi_i^-, \xi_i^+ \right) \quad (10)$$

$$e_{i,t}^{\min} \leq \sum_{t \leq t} \left( p_{i,t} - d_{i,t} \right) + e_{i,0} \leq e_{i,t}^{\max} \\ \forall i \in N_B, t \in N_T, \left( \mu_{i,t}^-, \mu_{i,t}^+ \right) \quad (11)$$

$$K_{i,t}^{a, \min} \leq \sum_{t \leq t} A_{i,t,t} \tilde{p}_{i,t} + K_{i,0}^a \leq K_{i,t}^{a, \max} \\ \forall i \in N_B, t \in N_T, \left( \tilde{\mu}_{i,t}^-, \tilde{\mu}_{i,t}^+ \right) \quad (12)$$

$$p_{i,t}^{\min} \leq p_{i,t} \leq p_{i,t}^{\max}, \forall i \in N_B, t \in N_T, \left( \sigma_{i,t}^-, \sigma_{i,t}^+ \right) \quad (13)$$

$$\tilde{p}_{i,t}^{\min} \leq \tilde{p}_{i,t} \leq \tilde{p}_{i,t}^{\max}, \forall i \in N_B, t \in N_T, \left( \tilde{\sigma}_{i,t}^-, \tilde{\sigma}_{i,t}^+ \right) \quad (14)$$

$$\alpha_i^l \geq 0, \forall t \in N_T, \left( \beta_i^l \right) \quad (15)$$

$$\alpha_i^v \geq 0, \forall t \in N_T, \left( \beta_i^v \right) \quad (16)$$

$$\sum_{jk \in N_s} x_{t,jk} = n_v - 1, \forall t \in N_T \quad (17)$$

$$C K_t = 1, \forall t \in N_T \quad (18)$$

$$\left| \left\{ K_t \right\}_{jk} \right| \leq M x_{t,jk}, \forall jk \in N_s, t \in N_T \quad (19)$$

The objective function in (1) can be divided into three parts: the first four terms represent the charging cost of EVs and HPs; the fifth and sixth terms represent penalty cost relating to the relaxations of constraints; and the seventh term is the cost of line losses. Constraints (2) and (3) represent active and reactive power flow balance. Constraint (4) is the line loading limit with the non-negative auxiliary variable  $\alpha_i^l$ . Constraints (5) and (6) force the active and reactive power to be zero if the corresponding switch is open. Constraint (7) represents the

voltage drop for those lines without switches. Constraints (8) and (9) represent that voltage drop equations are canceled for the lines whose switches are open. Constraint (10) is the voltage magnitude constraint with the non-negative auxiliary variable  $\alpha_i^v$ . Constraint (11) is the SOC constraint of each EV. Constraint (12) is the temperature constraint. Constraints (13) and (14) are EV charging power constraint and HP charging power constraint, respectively. Constraints (2), (3) and (17) can ensure a connected radial graph. Constraint (17) ensures that the total edges of the resulting graph (after reconfiguration) are the total vertexes minus one. Constraint (18) forces all load points being connected by supplying a unit fictitious active power ( $K_t$ ) to each load point from the substation. Constraint (19) forces the transferred fictitious power to be zero if the corresponding switch is open. The dual variables of constraints are given in the brackets.

After formulating the above relaxed reconfiguration based DSO optimization model, the DTs are calculated and sent to the aggregators. In general, the dual variables of a MILP problem can be derived based on the assumption that very small changes at the right sides of constraints will not change the discrete variables [19]. Suppose that the optimal solution  $(p_{i,t}^*, \tilde{p}_{i,t}^*, x_{t,jk}^*)$  is obtained, the dual variables can be calculated from the KKT conditions of the relaxed DSO optimization with fixed discrete variables ( $x_{t,jk}^*$ ). It should be mentioned that, in order to clearly explain the superior features of the relaxed DSO optimization in the following subsections, the relaxed DSO optimization model with fixed discrete variables ( $x_{t,jk}^*$ ) is transformed into an equivalent model. After obtaining the optimal solution of discrete variables ( $x_{t,jk}^*$ ), the network model is known in each optimization period. Thus, the power flow equations (2)-(3) and (5)-(6) are transformed into (20)-(21) by using the power transfer distribution factor (PTDF)  $D_t$ . Equations (7)-(9) are transformed into (22)-(23) by using the voltage incident matrix  $H_t$  (a matrix describing the relation between nodal voltage and voltage drop of each line). The equivalent model is as follows:

$$\min (1) \\ \text{subject to } (4), (10)-(16)$$

$$F_i^p = D_t \left( p_i^c - p_i^g + \sum_{i \in N_B} E_i \left( p_{i,t} + \tilde{p}_{i,t} \right) \right), \forall t \in N_T, \left( \lambda_t \right) \quad (20)$$

$$F_i^q = D_t \left( q_i^c \right), \forall t \in N_T \quad (21)$$

$$\Delta V_i^{\text{sqr}} = 2 \left( R F_i^p + X F_i^q \right), \forall t \in N_T, \left( \omega_t \right) \quad (22)$$

$$V_i^{\text{sqr}} = V_i^{b, \text{sqr}} - H_t \Delta V_i^{\text{sqr}}, \forall t \in N_T, \left( \gamma_t \right) \quad (23)$$

The dual variables can be obtained from the KKT conditions of the above equivalent model. The corresponding KKT conditions are as follows:

$$B_{i,t} p_{i,t} + c_i 1 + E_i^T D_t^T \lambda_t + \sum_{t \leq t} \left( \mu_{i,t}^+ - \mu_{i,t}^- \right) + \left( \sigma_{i,t}^+ - \sigma_{i,t}^- \right) = 0 \quad (24)$$

$$B_{i,t} \tilde{p}_{i,t} + c_i 1 + E_i^T D_t^T \lambda_t + \sum_{t \leq t} A_{i,t,t}^T \left( \tilde{\mu}_{i,t}^+ - \tilde{\mu}_{i,t}^- \right) \\ + \left( \tilde{\sigma}_{i,t}^+ - \tilde{\sigma}_{i,t}^- \right) = 0 \quad (25)$$

$$l_i^{\text{loss}} R F_i^p - \lambda_t + \pi_i^+ - \pi_i^- + 2 R^T \omega_t = 0 \quad (26)$$

$$\gamma_i + \xi_i^+ - \xi_i^- = 0 \quad (27)$$

$$-\omega_i + H_i^T \gamma_i = 0 \quad (28)$$

$$(w_i^l \mathbf{1}) - \pi_i^+ - \pi_i^- - \beta_i^l = 0 \quad (29)$$

$$(w_i^y \mathbf{1}) - \xi_i^+ - \xi_i^- - \beta_i^y = 0 \quad (30)$$

After the calculation of dual variables, the derived DTs, defined by  $D_i^T \lambda_i$ , will be sent to the aggregators. Then, each aggregator makes its own energy planning by the following optimization problem.

## 2) Aggregator Optimization

For aggregator  $i$ ,

$$\min \sum_{i \in N_T} \frac{1}{2} p_{i,t}^T B_{i,t} p_{i,t} + (c_i \mathbf{1} + E_i^T D_i^T \lambda_i)^T p_{i,t} + \frac{1}{2} \tilde{p}_{i,t}^T B_{i,t} \tilde{p}_{i,t} + (c_i \mathbf{1} + E_i^T D_i^T \lambda_i)^T \tilde{p}_{i,t} \quad (31)$$

subject to constraints (11)-(14).

The objective is to minimize the energy cost subject to constraints (11)-(14). Comparing the KKT conditions of the aggregator optimization with (24)-(30), it is concluded that the optimal solutions  $(p_{i,t}^*, \tilde{p}_{i,t}^*)$  at the DSO side can be achieved by independent optimizations at the aggregators side. The detailed analysis and proof of the equivalence between the DSO side optimization and the distributed optimizations at the aggregator side can be found in [9].

## 3) Existence of upper limit of DTs

In the KKT conditions (24)-(30), the LMs,  $\pi_i^+$ ,  $\pi_i^-$ ,  $\xi_i^+$ ,  $\xi_i^-$ ,  $\mu_{i,t}^+$ ,  $\mu_{i,t}^-$ ,  $\tilde{\mu}_{i,t}^+$ ,  $\tilde{\mu}_{i,t}^-$ ,  $\sigma_i^+$ ,  $\sigma_i^-$ ,  $\tilde{\sigma}_i^+$ ,  $\tilde{\sigma}_i^-$ ,  $\beta_i^l$ ,  $\beta_i^y$ , all the terms of matrix  $D_i$ ,  $H_i$ ,  $R$ , cost coefficient  $l_i^{loss}$  and penalty coefficients  $w_i^l$ ,  $w_i^y$  are all non-negative. According to (26)-(28), the derived DTs satisfy the following equation:

$$D_i^T \lambda_i = D_i^T l_i^{loss} R F_i^p + D_i^T (\pi_i^+ - \pi_i^-) + D_i^T (2R^T H_i^T (\xi_i^- - \xi_i^+)) \quad (32)$$

It is obvious that the DTs are determined by three parts that are associated with the line losses, line loading constraints and voltage magnitude constraints, respectively. In particular, if the corresponding voltage magnitude constraint does not bind, the associated third part is zero; therefore, the corresponding DT is only determined by the line losses and line loading constraints. Likewise, the second part is zero if the corresponding line loading constraint does not bind. The existence of the upper limit of DTs is described as follows.

According to (32), the following inequality is satisfied.

$$|\lambda_i| \leq l_i^{loss} R |F_i^p| + (\pi_i^+ + \pi_i^-) + 2R^T H_i^T (\xi_i^- + \xi_i^+) \quad (33)$$

According to (29), the following inequality is derived.

$$\pi_i^+ + \pi_i^- \leq (w_i^l \mathbf{1}) \quad (34)$$

According to (30), the following inequality is obtained.

$$\xi_i^- + \xi_i^+ \leq (w_i^y \mathbf{1}) \quad (35)$$

In addition, EVs and HPs charging power constraints (13) and (14) ensure that the line loading has maximum limit  $F_i^{p,lim}$ . Therefore, the following inequality is satisfied.

$$|F_i^p| \leq F_i^{p,lim} \quad (36)$$

According to (33)-(36), the derived DTs satisfy the following inequality.

$$|D_i^T \lambda_i| \leq D_i^T l_i^{loss} R F_i^{p,lim} + D_i^T (w_i^l \mathbf{1}) + 2D_i^T R^T H_i^T (w_i^y \mathbf{1}) \quad (37)$$

Thus, the DTs have an upper bound that is determined by the  $D_i$ ,  $R$ ,  $H_i$ ,  $F_i^{p,lim}$ ,  $l_i^{loss}$  and penalty coefficients  $w_i^l$ ,  $w_i^y$ . Before solving the relaxed reconfiguration based DSO optimization, the DSO knows all possible solutions of the network topology, which means that the DSO knows all possible  $D_i$  and  $H_i$  in (37).

In addition, the maximum loading limit  $F_i^{p,lim}$ , matrix  $R$  and coefficient  $l_i^{loss}$  are known parameters for the DSO. Based on the above analyses, the DSO can preset the maximum limit of DTs by choosing appropriate penalty coefficients. The DSO can determine the penalty coefficients by investigating the acceptable maximum value of DTs for customers. In addition, according to (34)-(36), it can be concluded that each part of DTs can be regulated separately.

## B. Market Agent Model in The Integrated Scheme

If congestion cannot be completely solved in the first step, flexibility products (SRPs/CRPs) are used to solve it. Because this paper focuses on the day-ahead time frame, only SRPs are considered. As assumed in [22], the flexibility products are characterized by time of service, location (node) of service, type of service, volume ( $p_i^fl$ ) and price ( $\pi_i^fl$ ). Regarding the flexibility bidding and pricing, assumptions are made according to the discussions in [14]. Because the generation bids are in a stepwise form in the day-ahead energy market, it is reasonable to bid the flexibility product in the same manner in the flexibility market.

After receiving a request of purchasing flexibility products to solve congestion, the market agent helps the DSO procure flexibility products with the minimum cost. The corresponding optimization model is as follows:

$$\min \sum_{i \in N_T} \sum_{i \in N_B} \sum_{g \in N_d} \sum_{f \in P_i^{(i,g)}} \{ \pi_i^fl \}_{i,g,f} \{ p_i^fl \}_{i,g,f} \{ z_i^{pur} \}_{i,g,f} \quad (38)$$

subject to

$$F_i^p = D_i (\bar{p}_i^{load} - \bar{p}_i^{gen}), \forall t \in \bar{N}_T \quad (39)$$

$$F_i^q = D_i (q_i^c), \forall t \in \bar{N}_T \quad (40)$$

$$|F_i^p| \leq f_i^{\max}, \forall t \in \bar{N}_T \quad (41)$$

$$\Delta V_i^{sqr} = 2(R F_i^p + X F_i^q), \forall t \in \bar{N}_T \quad (42)$$

$$V_i^{sqr} = V_i^{b,sqr} - H_i \Delta V_i^{sqr}, \forall t \in \bar{N}_T \quad (43)$$

$$V_i^{sqr,\min} \leq V_i^{sqr} \leq V_i^{sqr,\max}, \forall t \in \bar{N}_T \quad (44)$$

$$\{ z_i^{pur} \}_{i,g,f} \in \{0,1\}, \forall i \in N_B, g \in N_d, f \in P_i^{(i,g)} \quad (45)$$

$$\sum_{f \in P_i^{(i,g)}} \{ z_i^{pur} \}_f \leq 1, \forall i \in N_B, g \in N_d \quad (46)$$

The objective function (38) is to minimize the procurement cost of flexibility products. Constraints (39) and (40) are power balance equations. Constraint (41) ensures that the transmission capacity limit will not be violated after purchasing flexibility



products. Constraints (42) and (43) calculate nodal voltage magnitudes. Constraint (44) is the voltage magnitude limit. Constraint (45) reflects the purchasing state of the flexibility products. The binary variable  $z_i^{pur}$  is one if the corresponding flexibility product is purchased; otherwise,  $z_i^{pur}$  is zero. Constraint (46) means that the number of purchased products of each aggregator at each node in each period should be no more than one.

### C. Algorithm of the Comprehensive Scheme

The algorithm of the comprehensive scheme includes two sub-algorithms, namely the reconfiguration based DT (R-DT) algorithm and market agent algorithm. The flowchart of how the comprehensive algorithm combines the two algorithms is illustrated in Fig.2.

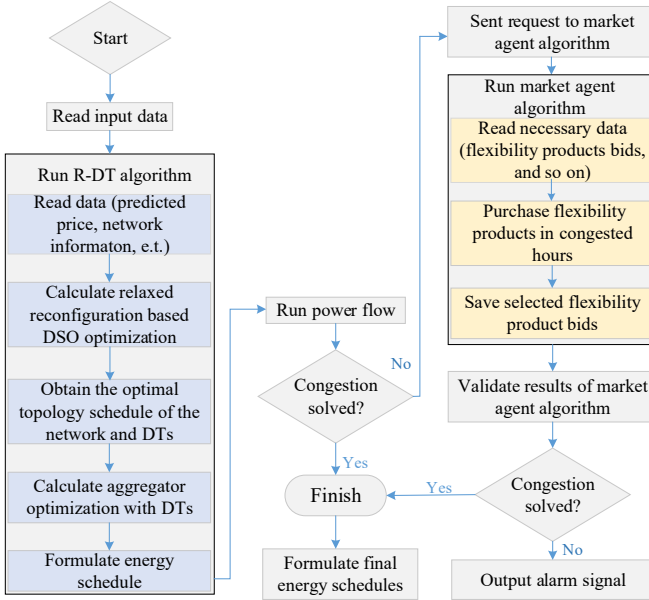

Fig. 2. The flowchart of the algorithm of the comprehensive scheme.

A brief description of the comprehensive algorithm is as follows: At first, the comprehensive algorithm reads input data. Then, it runs the R-DT algorithm. The R-DT algorithm first reads needed data, such as predicted spot prices and topology information of the network, and then it calculates the relaxed reconfiguration based DSO optimization and obtains optimal topology schedule of the network and DTs. With these DTs, it calculates the aggregator optimization and formulates the proposed energy schedules. After that, the power flow is conducted to check if the formulated energy schedules result in congestion under the obtained optimal topology schedule. If congestion does not exist, the comprehensive algorithm terminates; otherwise, a request signal is sent to the market agent algorithm. The market agent algorithm reads flexibility product bids, the optimal topology information and other needed information. Then, the market agent optimization is implemented to obtain optimal purchasing plan of flexibility products. If the results of the market agent algorithm show that congestion is solved, the selected flexibility product bids and proposed energy schedules are combined to create the final energy schedules; otherwise, an alarm signal is output.

## IV. CASE STUDIES

In order to validate the effectiveness of the proposed comprehensive scheme for congestion management within distribution networks, three case studies were conducted using the Danish driving pattern [23] and the modified Bus 4 distribution system of the Roy Billinton Test System (RBTS) [24].

### A. Grid Data and Simulation parameters

Fig. 3(a) shows the modified single line diagram of the Bus 4 distribution network to which six onsite DGs are connected. Line segments of feeders one to four are labeled, e.g., L2, L4, L6, L8, L9, L11, L12, L13 are the transformers connecting the loads points LP1-LP7 and DG1. In addition, the equivalent graphic diagram of the system is shown in Fig. 3(b), where the dotted lines indicate that the corresponding circuit breakers (CBs) are open.

The detailed data of the load points (residential and commercial customers) and line segments can be found in [24]. Table I lists the parameters of DGs and line loading limits. The key parameters of EVs and HPs are listed in Table II. The EV availability and system prices are the same as in [9]. It is assumed that each residential customer own one EV and one HP. In the three case studies, two aggregators are assumed. Aggregator1 has a contract with 80 customers per load point, DG5 and DG6; aggregator2 has a contract with the rest 120 customers per load point, DG1, DG2, DG3 and DG4. Moreover, 80 percent of EVs and HPs at each load point react to DTs, and the rest EVs, HPs and all DGs provide flexibility products. The lower voltage magnitude limit is set as 0.952 p.u. in order to consider approximated errors of voltage magnitudes and has a small margin compared to the physical limit (0.94 p.u.). The simulations were carried out using the Gurobi solver.

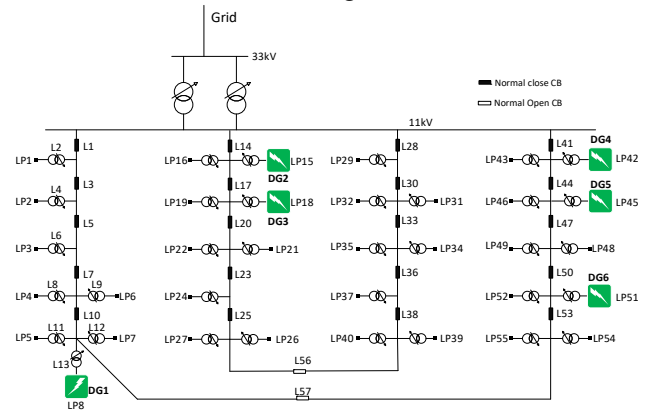

Fig. 3. (a) The modified Bus 4 distribution system of the RBTS

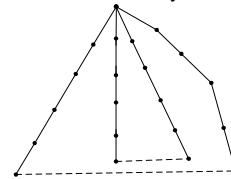

Fig. 3. (b) Equivalent graphic diagram



TABLE I  
PARAMETERS OF DGs AND LINE LIMIT

Parameters	Value
Active power capacity of DG1	500kW
Active power capacity of DG2, 3, 4, 5, 6	300kW
Line loading limit of L1: Case1 and 2/Case3	8000/ 7300kW
Line loading limit of L14: Case1 and 2/Case3	8300/ 8100kW
Line loading limit of L28: Case1 and 2/Case3	8900/ 9500kW
Line loading limit of L41: Case1 and 2/Case3	8000/ 7900kW
Resistance of the lines	0.26 ohm/km
Reactance of the lines	0.037 ohm/km

TABLE II  
KEY PARAMETERS OF EV AND HP

Parameters	Value
EV battery size	25kWh
Peak charging power	11kW (3 phase)
Energy consumption per km	150Wh/km
Minimum SOC	20%
Maximum SOC	85%
Average driving distance	40km
COP of HP	2.3
Minimum temperature of house	20 °C
Maximum temperature of house	24 °C

### B. Case Study Results

The effectiveness and advantages of the comprehensive scheme are verified in the following three cases. In Case 1, the advantage of integrating the network reconfiguration with the DT method is verified. Case 2 demonstrates that the relaxed reconfiguration based DT model can limit DTs to be below a preset threshold. Case 3 demonstrates that the relaxed reconfiguration based DT model can ensure a feasible solution when the original unrelaxed DT model is infeasible.

#### 1) Case1

In this case, the DT model without considering the network reconfiguration does not have a feasible solution for congestion management while integrating the network reconfiguration into the DT framework can obtain a solution. After performing the unrelaxed reconfiguration based DSO optimization model (removing auxiliary variables  $\alpha_i^l$  and  $\alpha_i^r$  from the relaxed reconfiguration based DSO optimization model), the resulting line loadings of L1, L14, L28 and L41 in critical hours are shown in Fig. 4 (d\_ev and d\_hp are EVs and HPs that react to DTs, p\_loads are EVs and HPs that provide flexibility products, e\_loads are equivalent conventional loads). It can be seen that all line loadings do not exceed line limits. The derived optimal topology schedule is shown in Fig. 5, the network topology changes frequently in order to achieve a feasible solution for congestion management. Therefore, it can be concluded that the integration of the DT and network reconfiguration can achieve a better solution for congestion management. In addition, the derived DTs are listed in TABLE III. Since the line loading of L14 reaches the limit in hours 18 and 19, high DTs (see case1 in Table III) are needed at the loading points of this congested line, i.e., LP16. Moreover, since the line loss is considered in the objective function, DTs are not zero even if there is no congestion, e.g., LP29-LP37 at “t19”.

After receiving DTs from the DSO, the aggregators conduct their own optimizations based on the DTs and base prices. The resulting line loadings are shown in Fig. 6. It is clear that the line loading of each line is the same as the one at the DSO side,

which demonstrates that the decentralized congestion management manner is achieved by the DTs.

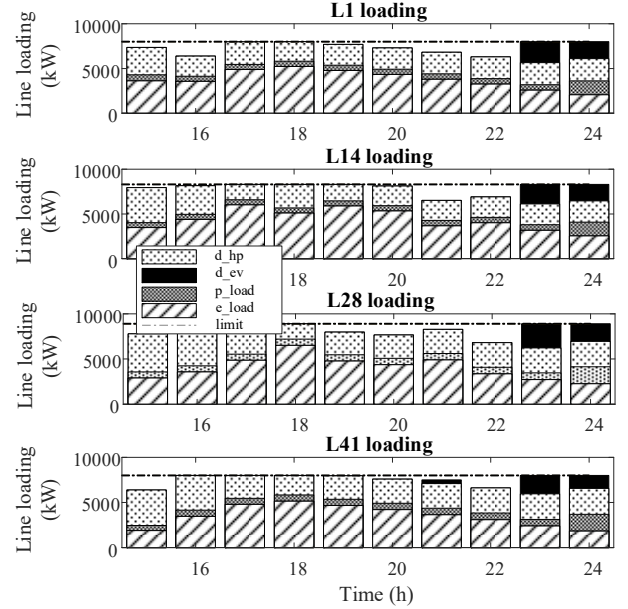

Fig. 4. Line loadings of the unrelaxed reconfiguration based DSO optimization in case 1.

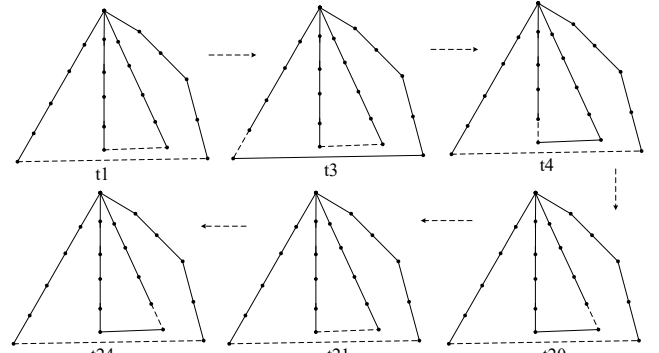

Fig. 5. Optimal topology schedule of the network in the planning periods.

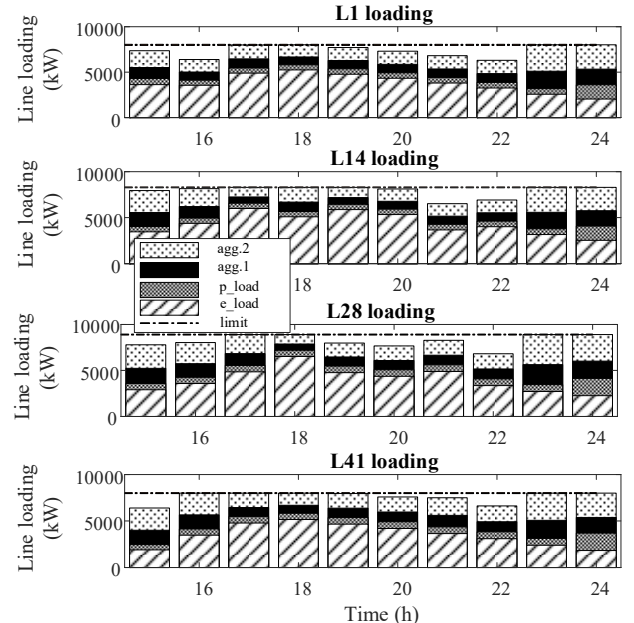

Fig. 6. Line loadings of the aggregator optimization with DTs in case 1.

In addition, since voltage magnitude constraints are included in the DT model, the voltage profile of critical bus LP 40 is shown in Fig. 7. Clearly, the voltage magnitude of bus LP 40 is above the minimum limit, and the maximum error between the approximated voltage magnitude and accurate one is around 1%.

TABLE III  
A PART OF VALUES OF DTs IN THREE CASES

Node	Case1		Case2		Case3	
Time	t18	t19	t18	t19	t18	t19
LP16	<b>2.5758</b>	<b>6.3251</b>	0.9251	2.5013	0.0012	0.0011
LP19	2.5765	6.3259	0.9259	2.5022	0.0019	0.0017
LP21	2.5773	6.3266	0.9266	2.5031	0.0026	0.0023
LP22	2.5773	6.3267	0.9267	2.5031	0.0027	0.0023
LP24	2.5777	6.3271	0.9270	2.5037	0.0030	0.0026
LP26	2.5777	6.3273	0.9270	2.5040	0.0030	0.0026
LP27	2.5777	6.3273	0.9270	2.5040	0.0030	0.0026
LP29	7.4928	<b>0.0012</b>	2.5014	0.0012	0.4192	0.0014
LP31	7.4938	<b>0.0020</b>	2.5025	0.0020	0.4202	0.0023
LP32	7.4937	<b>0.0019</b>	2.5024	0.0020	0.4202	0.0023
LP34	7.4944	<b>0.0024</b>	2.5031	0.0025	0.4209	0.0030
LP35	7.4945	<b>0.0025</b>	2.5032	0.0025	0.4210	0.0030
LP37	7.4948	<b>0.0026</b>	2.5035	0.0027	0.4213	0.0033
LP39	7.4948	6.3274	2.5036	2.5042	0.4214	0.0033
LP40	<b>7.4949</b>	6.3274	2.5036	<b>2.5044</b>	0.4214	0.0033
LP43	5.3677	0.0011	2.5012	2.5011	3.5012	3.5016
LP46	5.3686	0.0018	2.5020	2.5018	3.5019	3.5018
LP55	5.3694	0.0024	2.5027	2.5025	<b>3.5033</b>	3.5030

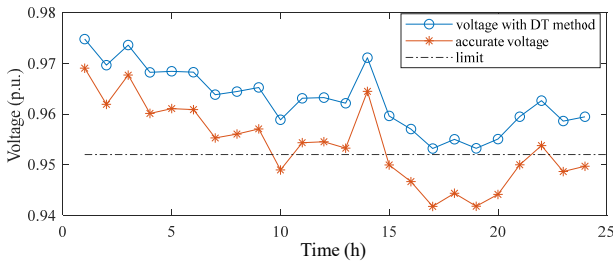

Fig. 7. Voltage profile of LP 40 in case 1.

2) Case 2

In case1, the congestion can be alleviated by the unrelaxed reconfiguration based DT model. However, as shown in Table III (case1), the maximum DT is 7.4949 DKK/kWh at bus LP 40 at “t18”, which denotes that customers face very high final prices. In order to resolve this issue, the relaxed reconfiguration based DT model that can limit the maximum value of DTs is performed. Since the maximum DT reaches 2.1DKK/kWh in the study in [9], it is safe to set the maximum limit of DTs as 3 DKK/kWh in this study. Given that the voltage magnitudes are not violated, the third part of the DT in (32) is zero. Therefore, there is no need to relax the voltage magnitude constraints and we set  $w_i^v$  to be a very big number, e.g.,  $1e10$ . Since the DTs in (32) are caused by the first two parts that are associated with the line loss and line loading constraints, the upper bound of DTs in (37) is determined by the first two parts. Moreover, as the line loss contributes a very small portion of DTs (the reason is that the upper bound of the first part of DTs ( $D_i^{loss} R F_i^{p,lim}$ ) is very small), the high DTs are caused by the line loading constraints and should be restricted by the  $w_i^l$ . Thus, we set  $w_i^l$  to be 2.5 to restrict the maximum value of the second part of DTs.

After the implementation of the relaxed reconfiguration based DT optimization, the resulting line loadings are shown in Fig. 8. It can be seen that line loadings of L14, L18 and L41

exceed the limits in hour 18 and 19. This means that the corresponding auxiliary variables (namely over-limit loading values listed in Table IV) are positive. The derived DTs are listed in Table III (case2). Clearly, the maximum value (2.5044 DKK/kWh) of DTs is restricted by (37). In such a case, the customers do not face very high DTs.

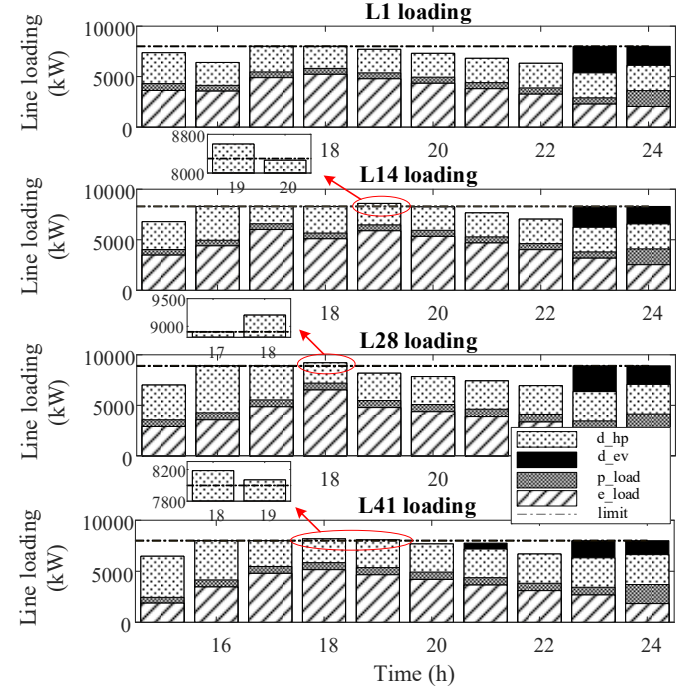

Fig. 8. Line loadings of the relaxed reconfiguration based DSO optimization in case 2.

Then, the market agent algorithm is invoked to solve the remaining congestion. There are several assumptions in the study. Firstly, the aggregators previously gather flexibilities from EVs, HPs and DGs, and sent SRPs bids to the day-ahead flexibility markets. Secondly, in order to solve congestion, two types of flexibility services are offered, namely consumption decrease from EVs and HPs (Type I) and generation increase from DGs (Type II). Take hour 18 as an example, Table V lists the offered SRPs in hour 18. The market agent algorithm is carried out to minimize the cost of the DSO procuring SRPs to mitigate unsolved congestion in L28 and L41 in hour 18. The selected SRPs and corresponding prices are highlighted in bold in Table V. After purchasing SRPs, as shown in Fig. 9 (a), the line loadings of L28 and L41 are below the line limits. Therefore, the comprehensive scheme can successfully alleviate congestion and does not incur very high final prices to customers.

TABLE IV  
OVER-LIMIT LOADING VALUES AFTER THE FIRST STEP

Unit (kW)	Line	After First step	
		t18	t19
Case2	1	-	-
	14	-	299.30
	28	301.30	-
	41	185.22	68.10
Case3	1	425.74	238.97
	14	-	-
	28	-	-
	41	134.47	58.96

TABLE V  
OFFERED SCHEDULED RE-PROFILING PRODUCTS IN HOUR 18 IN CASE 2

Node	Type	Aggregator1				Aggregator2			
		SRPs (kW)		Price (DKK/kWh)		SRPs (kW)		Price (DKK/kWh)	
29	I	20	<b>30</b>	0.44	<b>0.49</b>	30	<b>40</b>	0.45	<b>0.48</b>
31	I	12	20	0.35	0.42	18	<b>30</b>	0.37	<b>0.44</b>
32	I	20	<b>30</b>	0.43	<b>0.46</b>	30	<b>40</b>	0.44	<b>0.49</b>
34	I	16	28	0.38	0.44	24	<b>36</b>	0.40	<b>0.46</b>
35	I	20	28	0.42	0.49	30	<b>42</b>	0.44	<b>0.51</b>
37	I	12	<b>22</b>	0.37	<b>0.43</b>	18	<b>33</b>	0.39	<b>0.45</b>
42	II	-	-	-	-	60	<b>80</b>	0.79	<b>0.88</b>
43	I	15	24	0.37	0.41	18	24	0.39	0.41
45	II	60	<b>70</b>	0.77	<b>0.85</b>	-	-	-	-
46	I	12	16	0.37	0.39	17	36	0.37	0.48
48	I	15	28	0.37	0.41	19	36	0.39	0.48
49	I	13	25	0.35	0.41	19	24	0.40	0.43
51	II	40	50	0.57	0.65	-	-	-	-
52	I	12	21	0.35	0.42	24	<b>38</b>	0.40	<b>0.47</b>
55	I	11	25	0.34	0.43	17	20	0.39	0.41

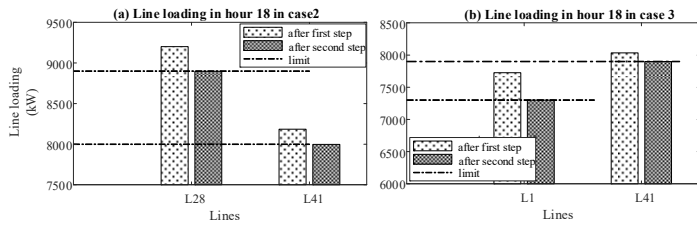

Fig. 9. Line loadings after applying market agent algorithm.  
3) Case 3

In this case, more severe congestion appears and the unrelaxed reconfiguration based DT model is infeasible. However, the relaxed reconfiguration based DT model can ensure a feasible solution and the proposed comprehensive scheme can effectively deal with such severe congestion.

In the situation of severe congestion, it is acceptable to set a higher limit for DTs. In this case, the maximum limit of DTs is set as 4 DKK/kWh, the penalty coefficient  $w_i^l$  and  $w_i^y$  are set as 3.5 and 10, respectively. After implementing the relaxed reconfiguration based DT optimization, the resulting line loadings are shown in Fig. 10 and the obtained DTs are listed in Table III (case3). Likewise, the maximum value (3.5033 DKK/kWh) of DTs is restricted. The voltage profile of the critical bus LP40, which is shown in Fig. 11, is above the minimum limit. As observed in Fig. 10, there is remaining unsolved congestion in L1 and L41 in hour 18 and 19. The over-limit loading values are listed in Table IV. In such a case, the market agent algorithm is activated to mitigate the remaining congestion. Take the hour 18 as an example, the selected SRPs and corresponding prices are highlighted in bold in Table VI. At last, the final loadings of L1 and L41 are below line limits, as shown in Fig 9(b). Clearly, the relaxed reconfiguration based DT model can ensure a feasible solution and the proposed comprehensive scheme is capable of dealing with the severe congestion situation without requiring very high DTs.

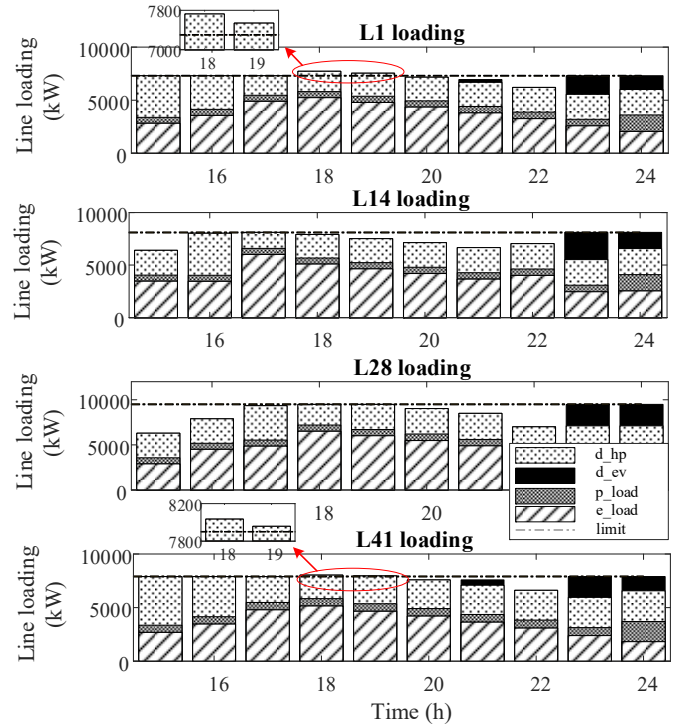

Fig. 10. Line loadings of the relaxed reconfiguration based DSO optimization in case 3.

TABLE VI  
OFFERED SCHEDULED RE-PROFILING PRODUCTS IN HOUR 18 IN CASE 3

Node	Type	Aggregator1				Aggregator2			
		SRPs (kW)		Price (DKK/kWh)		SRPs (kW)		Price (DKK/kWh)	
1	I	20	<b>30</b>	0.41	<b>0.49</b>	35	<b>40</b>	0.48	<b>0.54</b>
2	I	15	<b>20</b>	0.38	<b>0.42</b>	18	<b>30</b>	0.37	<b>0.44</b>
3	I	25	<b>30</b>	0.42	<b>0.46</b>	28	<b>40</b>	0.42	<b>0.53</b>
4	I	<b>23</b>	30	<b>0.39</b>	0.45	24	<b>36</b>	0.40	<b>0.46</b>
6	I	25	<b>35</b>	0.44	<b>0.49</b>	32	<b>42</b>	0.45	<b>0.51</b>
8	II	-	-	-	-	80	<b>100</b>	0.82	<b>0.91</b>
42	II	-	-	-	-	60	<b>80</b>	0.79	<b>0.88</b>
43	I	18	24	0.39	0.41	18	24	0.39	0.41
45	II	50	70	0.67	0.89	-	-	-	-
46	I	12	16	0.37	0.39	19	36	0.38	0.48
48	I	10	28	0.35	0.44	<b>19</b>	37	<b>0.39</b>	0.53
49	I	15	25	0.39	0.41	22	24	0.40	0.41
51	II	40	50	0.57	0.65	-	-	-	-
52	I	12	21	0.36	0.42	27	<b>38</b>	0.42	<b>0.47</b>
55	I	11	25	0.34	0.43	18	20	0.39	0.41

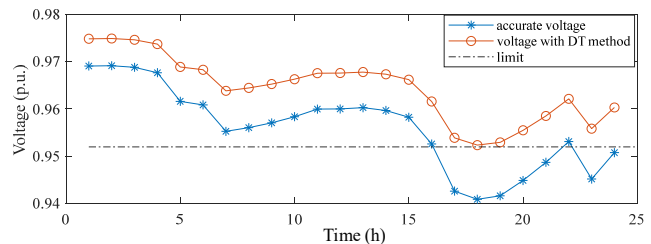

Fig. 11. Voltage profile of LP 40 in case 3.

## V. CONCLUSION

In this paper, a comprehensive scheme is proposed to combine the DT, network reconfiguration and re-profiling products to perform day-ahead congestion management. The proposed scheme makes full use of the advantages of the three

methods to solve congestions. Particularly, a relaxed reconfiguration based DT optimization model is formulated to resolve the possible infeasible issue and regulate DTs. The simulation results show that the propose scheme can utilize the flexibilities provided by EVs, HPs and onsite DGs to solve congestion and ensures that customers do not face very high DTs. Moreover, the proposed scheme is able to deal with extreme situation when the original unrelaxed DT model is infeasible.

#### REFERENCES

- [1] P. Hallberg, et al. "Active distribution system management-A key tool for the smooth integration of distributed generation," Eurelectric, Brussels, Belgium, Feb. 2013.
- [2] ETSA Utilities, "Reasonableness test RT 015/11 Salisbury Substation 11kV feeders", May 2012. [Online] Available: <https://www.sapowernetworks.com.au/public/download.jsp?id=21385>.
- [3] G. Granelli, M. Montagna, F. Zanellini, P. Bresesti, R. Vailati, and M. Innorta, "Optimal network reconfiguration for congestion management by deterministic and genetic algorithms," *Elect. Power Syst. Res.*, vol. 76, pp. 549–556, Apr. 2006.
- [4] S. Huang, Q. Wu, Z. Liu, and A. H. Nielsen, "Review of congestion management methods for distribution networks with high penetration of distributed energy resources," in *Proc. 2014 IEEE PES Innovative Smart Grid Technologies, Europe*, pp. 1-6.
- [5] P. M. Sotkiewicz and J. M. Vignolo, "Nodal pricing for distribution networks: Efficient pricing for efficiency enhancing DG," *IEEE Trans. Power Syst.*, vol.21, no.2, pp. 1013–1014, May 2006.
- [6] F. Meng and B. H. Chowdhury, "Distribution LMP-based economic operation for future smart grid," in *Proc. 2011 IEEE Power and Energy Conference at Illinois*, pp. 1–5.
- [7] Linquan Bai, Jianhui Wang, Chengshan Wang, et al. "Distribution locational marginal pricing (DLMP) for congestion management and voltage support," *IEEE Trans. Power Syst.*, to be published.
- [8] N. O'Connell, Q. Wu, J. Østergaard, A. H. Nielsen, S. T. Cha, and Y. Ding, "Distribution locational marginal pricing for optimal electric vehicle charging management," *IEEE Trans. Power Sys.*, vol.29, no.1, pp. 203-211, Jan, 2014.
- [9] S. Huang, Q. Wu, S. S. Oren, R. Li, and Z. Liu, "Distribution locational marginal pricing through quadratic programming for congestion management in distribution network," *IEEE Trans. Power Sys.*, vol.30, no.4, pp. 2170-2178, Jul. 2015.
- [10] R. Li, Q. Wu, and S. S. Oren, "Distribution locational marginal pricing for optimal electric vehicle charging management," *IEEE Trans. Power Syst.* vol.29, no.1, pp. 203-211, Jan. 2014.
- [11] S. Huang and Q. W, "Dynamic subsidy method for congestion management in distribution network," *IEEE Trans. Smart Grid*, to be published.
- [12] B. Biegel, P. Andersen, J. Stoustrup, and J. Bendtsen, "Congestion management in a smart grid via shadow prices," In *Proc. 2012 8<sup>th</sup> IFAC Symposium on Power Plant and Power System Control*, pp. 518-523.
- [13] C. Zhang, Y. Ding, N. Nordentoft, P. Pinson, and J. Østergaard, "FLFCH-A danish market solution for DSO congestion management through DER flexibility service," *J. Mod. Power Syst. Clean Energy*, vol.2, no.2, pp. 126-133, 2014.
- [14] Esmat A, Usaola J. "DSO congestion management using demand side flexibility," *CIREN Workshop 2016, Helsinki*. pp. 1–4.
- [15] R. Belhomme, M. Sebastian, "Deliverable 1.1 ADDRESS – Technical and commercial conceptual architectures," Oct. 2009. [Online] Available: [http://www.addressfp7.org/config/files/ADD-WP1\\_Technical\\_and-Commercial\\_Architectures.pdf](http://www.addressfp7.org/config/files/ADD-WP1_Technical_and-Commercial_Architectures.pdf).
- [16] A. Kulmala, M. Alonso, S. Repo, H. Amaris, et al. "Hierarchical and distributed control concept for distribution network congestion management," *IET Generation, Transmission & Distribution*, vol.11, no.3, pp. 665–675, 2017.
- [17] A. Esmat, P. Pinson, J. Usaola, "Decision support program for congestion management using demand side flexibility", In *Pro. 2017 IEEE Power Tech. Conference at Manchester*.
- [18] T. H. Vo, A. N. M. M. Haque, "A study of congestion management in smart distribution network based on demand flexibility", In *Pro. 2017 IEEE Power Tech. Conference at Manchester*.
- [19] S. Huang, Q. Wu, L. Cheng, and Z. Liu, "Optimal reconfiguration-based dynamic for congestion management and line loss reduction in distribution network," *IEEE Trans. Smart Grid*, vol.7, no.3, pp. 1295-1303, May 2016.
- [20] A. N. M. M. Haque, M. Nijhuis, "Integrating direct and indirect Load control for congestion management in LV networks," *IEEE Trans. Smart Grid*, to be published.
- [21] Catalonia institute for energy research, et al, "IDE4L, Deliverable 6.1: Optimal scheduling tools for day-ahead operation and intraday adjustment. Part II: Commercial Aggregator Concept," 2015. [Online] Available: <http://ide4l.eu/results/>
- [22] A. Kulmala, et al., "IDE4L, deliverable 5.2/3: Congestion management in distribution network," 2015. [Online] Available: <http://ide4l.eu/results/>.
- [23] Q. Wu et al., "Driving pattern analysis for electric vehicle (EV) grid integration study," in *Proc. IEEE PES Innov. Smart Grid Tech. Conf. Europe (ISGT) at Sweden*, 2010, pp. 1–6.
- [24] R. N. Allan, R. Billinton, I. Sjarief, L. Goel, and K. S. So, "A reliability test system for educational purposes-basic distribution system data and results," *IEEE Trans. Power Syst.*, vol. 6, no. 2, pp. 813–820, May 1991.