



## Applying Synchronous Condenser for Damping Provision in Converter-dominated Power System

Nguyen, Ha Thi; Yang, Guangya; Nielsen, Arne Hejde; Jensen, Peter Højgaard ; Pal, Bikash Chandra

*Published in:*  
Journal of Modern Power Systems and Clean Energy

*Link to article, DOI:*  
[10.35833/MPCE.2020.000207](https://doi.org/10.35833/MPCE.2020.000207)

*Publication date:*  
2021

*Document Version*  
Peer reviewed version

[Link back to DTU Orbit](#)

*Citation (APA):*  
Nguyen, H. T., Yang, G., Nielsen, A. H., Jensen, P. H., & Pal, B. C. (2021). Applying Synchronous Condenser for Damping Provision in Converter-dominated Power System. *Journal of Modern Power Systems and Clean Energy*, 9(3), 639-647. <https://doi.org/10.35833/MPCE.2020.000207>

---

### General rights

Copyright and moral rights for the publications made accessible in the public portal are retained by the authors and/or other copyright owners and it is a condition of accessing publications that users recognise and abide by the legal requirements associated with these rights.

- Users may download and print one copy of any publication from the public portal for the purpose of private study or research.
- You may not further distribute the material or use it for any profit-making activity or commercial gain
- You may freely distribute the URL identifying the publication in the public portal

If you believe that this document breaches copyright please contact us providing details, and we will remove access to the work immediately and investigate your claim.

# Applying Synchronous Condenser for Damping Provision in Converter-dominated Power System

Ha Thi Nguyen, Guangya Yang, Arne Hejde Nielsen, Peter Højgaard Jensen, and Bikash Pal

**Abstract**—The dynamic characteristics of converter-dominated systems are governed by the controls of power converters and the interactions among the converter systems and conventional alternators. Frequency oscillations can appear during dynamic operating conditions caused by the phase-locked loop dynamics and the interactions among the converter control systems. The oscillations may be poorly damped that can result in reduced power generation, longer settling time or disconnections of sensitive components. It is foreseeable that damping services will be critical for grid stabilization in the future with high penetration of renewable generation. In this work, synchronous condensers are evaluated and applied for providing damping services to the grid in post-event conditions. An innovative supplementary controller for the automatic voltage regulator of synchronous condensers is proposed to improve frequency stabilization in a converter dominated system after disturbances. Utilizing local and remote measurements, synchronous condensers are able to modulate the reactive power output hence the terminal bus voltage, which further impacts on the power flow in the system, therefore, it provides damping to the frequency oscillations. The control is implemented on an industrial level hardware platform and the performance is verified by hardware-in-the-loop simulation.

**Index Terms**—: Power oscillation, Prony analysis, low inertia systems, supplementary controller, synchronous condenser.

## I. INTRODUCTION

Synchronous condenser (SC) has a long historical use in power systems for reactive power compensation. SCs had been proven successfully applied to many grids in the world for dynamic voltage regulation and short-circuit current support. [1]–[9].

The rapid penetration of renewable energy sources (RES) into power systems has introduced many challenges in securing a stable network operation and has forced power systems

to operate in low inertia conditions. Systems based on converter-interfaced RES do not have the stronghold as the conventional systems due to a lack of synchronous machines in operation. In such a system, the internal dynamics against an external disturbance are highly dependent on the control of the main converter stations and their interactions within themselves as well as with the synchronous units. SCs had been proven as an effective solution for supporting system dynamic performance and renewable: interconnection in low inertia systems. SCs providing inertial and frequency response in renewable-based systems had been investigated in [10]–[13].

For a converter, frequency and power are coupled through their control system. From the system point of view, this artificial coupling can affect frequency as a global parameter for power regulation due to the heterogeneous design and response of the measurement and control systems of the converters. When the number of converters increases in a system, the locality of frequency will increase which increases the heterogeneity of the entire network. Hence, faster frequency dynamics with unexpected power oscillations may occur at system level at different operating conditions and generator mix after an external disturbance.

A frequency response with faster dynamics and an undesirable oscillation during a generation loss disturbance was experienced in the simulated Great Britain power system due to the inertia reduction [14]. The impacts of wind power penetration on the low-frequency oscillation modes of the IEEE 39-bus New England power system is investigated in [15]. The oscillation frequency is dependent on the inherent inertia of the involved network (can be a sub-network) as well as the bandwidth of the measurement and control systems of converters within the network. While traditional PSS does not work well for SCs and will not be suitable for renewable-based systems where synchronous generator will be gradually phased out.

To help the frequency dynamic improvement and the damping of the oscillations from the system level, the paper exploits the controllability of SCs. As SC itself does not control active power, the control effect over system power and frequency oscillations will be through its reactive power channel via its excitation control. In [16], SCs can provide damping torque via its fast excitation control has been theoretically proven by small-signal analysis.

To use the SC to provide damping in frequency for converter-based systems, this paper proposes a design principle

---

Manuscript received: April 2, 2020; accepted: August 19, 2020. Date of Cross-Check: August 19, 2020. Date of online publication: XX XX, XXXX. This work was supported by Synchronous Condenser Application (SCAPP) project funded by ForskEL program, grant no. 12196 administrated by Energinet.dk.

This article is distributed under the terms of the Creative Commons Attribution 4.0 International License (<http://creativecommons.org/licenses/by/4.0/>).

H. T. Nguyen and A. H. Nielsen are the Department of Electrical Engineering, Danmarks Tekniske Universitet, Denmark (e-mail: thangu@elektro.dtu.dk; ahn@elektro.dtu.dk).

G. Yang is with the Electrical Engineering, Technical University of Denmark, Denmark (e-mail: gyy@elektro.dtu.dk).

P. H. Jensen is with Siemens AG Sektor Energie, Denmark (e-mail: peter\_hoejgaard.jensen@siemens.com).

B. Pal is with the Department of Electrical and Electronic Engineering, Imperial College London, UK (e-mail: b.pal@imperial.ac.uk).

DOI: 10.35833/MPCE.2020.000207



of a power oscillation damping (POD) controller as a supplementary controller for SCs, where reactive power is used to modulate the active power flow of main flow paths in the system through node voltage regulation. In this way, active power oscillations after the disturbance can be damped quicker, and the system can regain a stable frequency sooner after a major frequency disturbance. The design uses both local and remote measurements from the systems, where in the proposed controller, measurements of local frequency and a remote tie-line flow are used as inputs while the output is the SCs reactive power. By modulating the SC bus terminal voltage in terms of the magnitude and the phase, the active power of transmission lines and loads in the system can be affected at a global scale which helps to damp the oscillations and enhance the frequency stability both on frequency nadir and settling time.

The study is purely based on electromagnetic transient simulation (EMT), where the case study is based on an observed oscillation in a modified Danish power system. A parameter optimization based on software-in-the-loop (SiL) linking a real-time digital simulator (RTDS) and MATLAB through OPC (object linking and embedding for process control) communication is implemented [17]. Prony technique is applied to extract the dominant oscillation frequency and damping ratio from the system frequency measurement. The near-optimal or optimal parameter set of the POD controller is determined by a gradient-free algorithm to maximize the damping effect. To validate the effectiveness of the proposed method, the prospective future Western Danish (DK1) power system supplied by renewable energy sources and multiple interconnections with neighboring countries is used. Comparative results show that the POD controller provided enhancement in the system in terms of oscillation damping and frequency stability.

The remaining of the paper is organized as follows: the proposed method is clarified in Section II, which explains the impact of the SC on the improvement of the power oscillation damping and frequency stability during disturbances via its reactive power control channel. Section III reveals the communication system setup of the control parameterization by RTDS, MATLAB, and OPC. Based on the proposed approach, the prospective future Western Danish power system is used to test the low inertia system verification of the POD controller in Section IV. Finally, conclusions are drawn in Section V.

## II. DESIGN METHODOLOGY AND PROPOSED POD STRUCTURE

Power oscillations in a converter-dominated system can take place between the subnetworks, where in a subnetwork a cluster of dynamic components including HVDC links, synchronous and non-synchronous generators, and loads are located in a vicinity where similar local information was presented to their control systems. A subnetwork may represent a center of inertia, where the components in a subnetwork can oscillate against one or several other subnetworks in the system during a disturbance. This phenomena was considered inter-area oscillations where the characteristics are gov-

erned by synchronous machines. However, with the increasing amount of power converters in the system, the control system of power converters start to play a major role in the oscillation analysis. A number of field events have been reported in recent years.

### A. Design methodology

The oscillations in a system can be suppressed by controlling the critical flow paths in a network. This can be achieved by controlling active or reactive power of controllable units in the system, provided a designated control system can handle the expected oscillatory frequencies. To effectively achieve the damping effect, one might consider using measurements of line flows as immediate inputs for a controller. Synchronous condenser can only provide volt/var control to a system, however, volt/var can impact the system power flow in a number of ways as described below.

The mathematical formula of the transferred active power on a simplified transmission line can be expressed as:

$$P = \frac{V_1 V_2}{X} \sin \delta \quad (1)$$

where  $V_1$  and  $V_2$  are the line-to-line voltages of the two end sides of the transmission line;  $\delta$  is the angle of  $V_1$  with respect to  $V_2$ ; and  $X$  is the reactance of the transmission line.

The active power of a load expressed in a voltage and frequency dependent load (V&FDL) model [18] is as follows:

$$P_{Load} = P_0 (1 + k_{pf} \Delta f) (p_p + p_c \frac{V}{V_0} + p_z (\frac{V}{V_0})^2) \quad (2)$$

where  $P_0$  is the rated active power of the load;  $V_0$  and  $V$  are the nominal and actual voltage magnitude at the load bus, respectively;  $f_0$  and  $\Delta f$  are the nominal frequency and frequency deviation, respectively;  $k_{pf}$  is the frequency characteristic coefficient; and  $p_p$ ,  $p_c$ , and  $p_z$  are the portions of total load proportional to constant active power load, constant current load, and constant impedance load, respectively.

The active power of the LCC-HVDC link at the rectifier is expressed as follows:

$$P_{HVDC} = 1.654 V_m I_d \cos \alpha \quad (3)$$

where  $V_m$  is the peak line-to-line voltage of the AC terminal;  $I_d$  is the DC current of the HVDC; and  $\alpha$  is the firing angle of the rectifier.

The basic control principle of the LCC-HVDC link is that the rectifier controls the DC current and the  $\alpha$  limit, whereas the inverter is responsible for a constant extinction angle control to keep the transferred power tracking to the set point.

According to (1)-(3), the active power on the transmission lines, LCC-HVDC links, and loads can be manipulated by the AC terminal voltage which can be controlled via the excitation of SCs with a supplementary POD controller. The principle of proposed method manages to control the terminal voltage in terms of magnitude and phase via the excitation of SCs, which in turn adjusts active powers of loads, LCC-HVDC and the power transferred on transmission line connected directly to the SC terminal. Consequently, it helps to damp the oscillation in voltage, power, and frequency.

### B. Power Oscillation Damping Controller

A POD control design incorporating SCs adapting to the modern system characteristics is developed. By regulating the terminal voltage through the reactive power modulation, the POD controls the active power transferred on the transmission lines, HVDC links, and loads to damp the power oscillation and improve the frequency stability.

The lead-lag control structure is still preferred due to a better tradeoff between the static accuracy, system stability and insensitivity to disturbances in the frequency domain [19]. Low-frequency oscillation can be efficiently damped by the proper selection of lead-lag block parameters.

In the literature, many valuable input signals of the POD controller are suggested, including the rotor speed deviation, the frequency, the electrical power or the acceleration power [20]-[22]. It is worth noting that the frequency behavior represents the active power oscillation or imbalance; therefore, it is selected as an input to damp the power oscillation. Furthermore, due to the locality of the frequency in a low inertia system, it is essential to select a signal from a central path of the oscillation as one of the inputs, where in this case, a measured tie line flow between the Danish and German system is selected. In implementation, this measurement is best taken by synchrophasor measurement units to maintain time synchronization with the local measurements.

Figure 1 shows the control diagram of the proposed POD controller. The POD controller takes local frequency measurement and active power on a tie line as input signals to create a POD output, which is then added to the AVR of the SC. This output regulates the excitation field current to control the terminal voltage, which therefore changes the active power on the tie line, HVDC links and voltage-dependent loads to enhance the power oscillation and frequency deviation during disturbances. To begin with the first control input, a deadband is applied to eliminate small frequency changes that may result in an unexpected contribution of POD during steady state conditions. A following low-pass filter ( $\frac{1}{1+sT_L}$ ) filters the measurement noise that can make the

control function poor. There are 2 control signals created by the frequency measurement. The first one, with a small time constant ( $T_{w1}$ ), works similar to a differentiation to capture the frequency derivation during frequency excursions. The second, with a larger time constant ( $T_{w2}$ ), catches the frequency deviation to generate a signal with a longer response time. The second input (active power on a tie line) first moves through a washout, which allows the desired frequency oscillation mode (inter-area oscillation around 0.1 Hz to 1.5 Hz) to pass and optimizes the compensation at low-frequency range (normally less than 0.5 Hz).

The magnitude and phase shift of the output are adjusted through control gains ( $K_1$ ,  $K_2$ , and  $K_3$ ) and the lead/lag time constants ( $T_1$  and  $T_2$ ) to compensate the system oscillation. They are optimized by the objective function of genetic algorithms (GA). The GA objective is to maximize the damping ratio of the dominant oscillation mode of the system frequency.

A limiter is a crucial part of each controller that hedges

the control participation in conditions of uncertainty. This limiter is more critical when the SC connected to the same bus with voltage-sensitive components, such as PV sources or wind power plants which have strict fault ride-through requirements and voltage-based protection settings. These limitation values may change from site to site depending on grid codes.

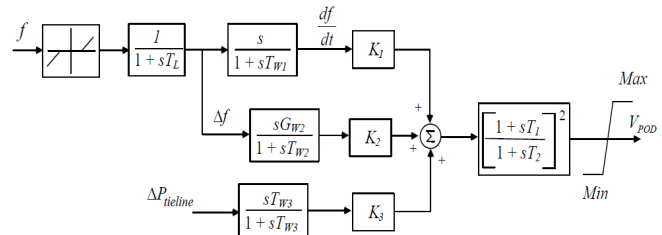

Fig. 1. Proposed POD control structure.

### III. CONTROL TUNING PROCEDURES

The tuning process is based on EMT simulation of detailed power grid model, where on top of the simulation model a non-linear optimization procedure is added to optimize the controller parameters with respect to system performance. This is by far the most suitable procedure with respect to EMT simulation, as conventional analytical eigenvalue analysis is exclusively used on stability analysis function (RMS) representation of system, where the dynamics inside converter control is ignored due to the mismatch between the operating time scales.

A prospective power system run in the RTDS platform is driven by a MATLAB script for system startup and disturbance simulations. The data of the system are collected by an OPC server and sent directly to the MATLAB workspace. In MATLAB, the signal is first processed to remove the fundamental frequency component. The oscillation component is then analyzed by the Prony technique for extracting the frequency and damping ratio of the dominant oscillation mode. The damping ratio is maximized by a GA objective function to determine the better parameters of the POD. GA is a global heuristics parameter search technique based on genetic operators to find the optimal or near-optimal solutions for each specific problem [23], [24]. Unlike the traditional optimization approaches that require one starting point, GA uses a set of points (chromosomes) as the initial condition and each chromosome is evaluated for its performance according to the objective function which characterizes the problem to be solved and defined by the designers. After that, these parameters are updated on the RTDS model for further verification. These steps are iterative by a closed-loop and run in real time with the RTDS, OPC, and MATLAB communications as shown in Fig. 2. The loop will continue until the objective function satisfies the damping ratio maximization of the dominant mode constraint to determine the optimal values of POD parameters.

#### A. Prony analysis

A Prony analysis is a least-square approximation technique of fitting a linear sum of exponential terms to a mea-



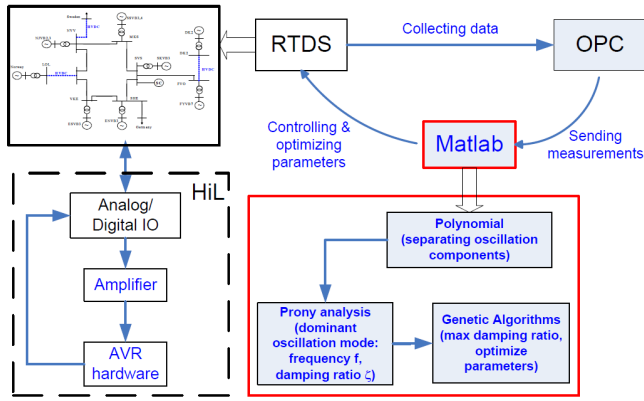

Fig. 2. System arrangement of the HiL and SiL simulations.

sured signal. A brief overview of this technique is given in [25]. The important feature of this technique is that it directly determines the frequency, damping ratio, energy, and relative phase of the modal components present in a given measurement signal by an extended Fourier analysis [26]. The ability to extract such information from transient signal simulations would overcome the computing burden of the linear model for large-scale systems.

Consider a generally continuous signal  $y(n)$  that is to be modeled by

$$y(n) = \sum_{i=1}^p (b_i z_i^n) = \sum_{i=1}^p A_i e^{j\theta_i} e^{(\alpha_i + j2\pi f_i)n\Delta t} \quad (4)$$

with

$$\begin{cases} b_i = A_i e^{j\theta_i} \\ z_i = e^{(\alpha_i + j2\pi f_i)n\Delta t} \end{cases}$$

where  $n=0, 1, 2, \dots, N-1$ ,  $N$  is the sampling number;  $\Delta t$  is the time interval of sampling;  $p$  is the order of the Prony mode;  $A_i$  and  $\theta_i$  are the amplitude and inception phase angle of the  $i$ th oscillation mode, respectively; and  $f_i$  and  $\alpha_i$  are the frequency and damping ratio of the  $i$ th oscillation mode, respectively.

Overall, Prony analysis can be summarized into three steps:

- 1) Constructing a linear prediction model from the measured data and solving it.
- 2) Computing the discrete-time poles of the characteristic polynomial equation generated by the linear model, which in turn results in the eigenvalues.
- 3) From these eigenvalues, the damping ratios and oscillation frequencies and related parameters can be extracted.

Before determining the information of the measured data, a signal processing step is implemented to remove the fundamental frequency. This step separates the oscillatory component for a Prony analysis conduction. The Prony analysis obtains many oscillation modes, including dominant modes and noise modes. This observation results from the mixing noise and trend in the measurement, which cannot be eliminated completely in the signal processing step.

The dominant mode is recognized by the energy analysis approach, which evaluates the contribution of each oscillation mode and is expressed as follows:

$$E_i = \sum_{n=0}^{N-1} (R_i z_i^n)^2 \quad (5)$$

where  $E_i$ ,  $R_i$ , and  $z_i$  are the energy, the amplitude, and the pole of the  $i$ th oscillation mode, respectively; and  $i=1, 2, \dots, p$ . The dominant mode is the largest energy contribution to the oscillation.

### B. Overall fitting procedure

In this paper, five parameters ( $T_1$ ,  $T_2$ ,  $K_1$ ,  $K_2$ , and  $K_3$ ) of the POD controller are optimized by a damping ratio maximization objective function through a gradient free solver that is Genetic Algorithm in this case. The main control design goal is maximizing the damping ratio of the system oscillation mode.

$$f(x) = \max \left\{ \zeta = -\frac{\alpha}{\sqrt{\alpha^2 + \beta^2}} \right\} \quad (6)$$

subject to

$$T_{imin} \leq T_i \leq T_{imax} \quad (i=1, 2) \quad (7)$$

$$K_{jmin} \leq K_j \leq K_{jmax} \quad (j=1, 2, 3) \quad (8)$$

where  $\alpha$  and  $\beta$  are the real and imaginary parts of the dominant mode, respectively. The optimization determines the variables  $x$  ( $T_1$ ,  $T_2$ ,  $K_1$ ,  $K_2$ , and  $K_3$ ) based on the boundary settings to maximize the damping ratio  $\zeta$  of the oscillation mode. Table I shows the boundary setting of the POD controller.

TABLE II  
WITHOUT, WITH PSS, AND WITH OPTIMAL POD COMPARISON OF  
DOMINANT MODE

Cases	Dominant mode	Frequency (Hz)	Damping ratio	Frequency nadir (Hz)	Settling time (s)
WO	-0.525±j6.585	1.048	0.079	49.7	~17
WPSS	-0.635±j6.870	1.093	0.092	49.71	~16
WPOD	-1.933±j6.379	1.015	0.29	49.82	~8

## IV. CASE STUDY

The case study section is based on an observed damped oscillation after major frequency disturbances, causing a long settling time in frequency after disturbances. The system is a modified Western Danish system that considers the major planned upcoming wind power plants and HVDC links as shown in Fig. 3. The system contains HVDC links, Type III and Type IV wind turbines, and three synchronous condensers distributed at the major HVDC terminals in the system [27] without synchronous generators. The system is synchronized with the German grid, which is modelled by a simplified synchronous machine with a low inertia constant. An oscillation is found after a frequency disturbance, as shown in Fig. 4.

The oscillation, verified by a sensitivity study, takes place between the major converter stations and the external grid, instead of by synchronous machines only, which in this case are synchronous condensers. To illustrate the contributions of different components to the oscillation, Figure 5 contains

two scenarios investigated in the whole DK1 renewable-based system (WDK1): one applied with/without a major wind power plant (WOWPP) (Fig. 5(a)) and another applied with and without a synchronous condenser (WOSC) (Fig. 5 (b)). It can be seen that without the major wind power plant in the back curve, the post contingency oscillation of the frequency response is highly reduced, and rapidly damped. Meanwhile, the oscillation effect without a synchronous condenser is only in phase delay. It can be envisaged that by

having more power converters replacing synchronous machines in a power system, converters will become the main oscillation source. Due to the complexity of the inertia characteristics of a low inertia system, the mode of oscillation may shift over time, depending on the types of generators online and the performance of the converter control systems. This requires innovative solutions for an oscillation damping controller that adapts to the modern system characteristics to guarantee a secure operation.

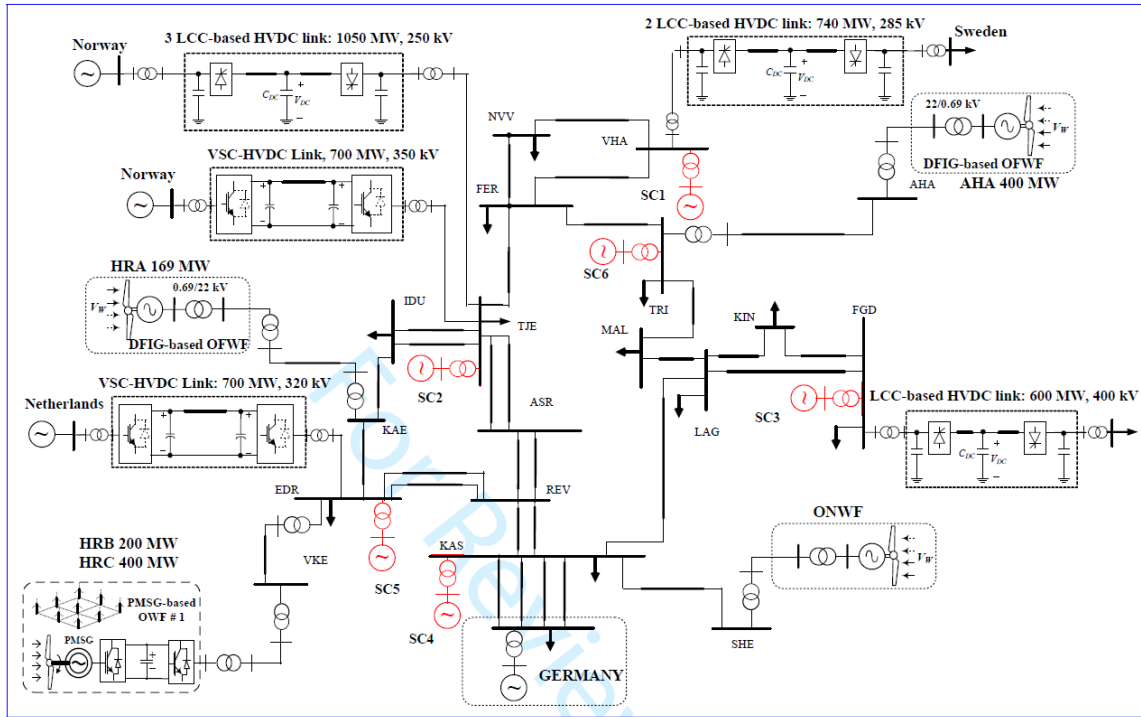

Fig. 3. Single-line diagram of a 400 kV Western Danish renewable-based system in 2020.

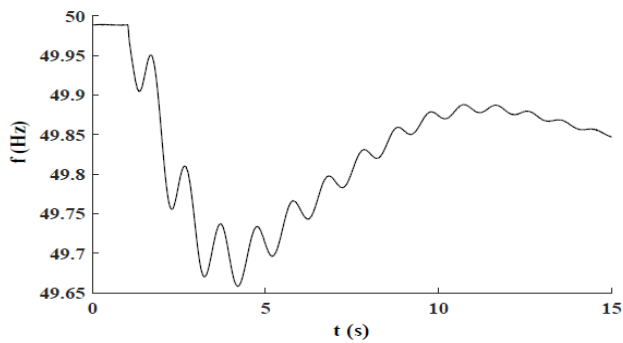

Fig. 4. Power oscillation in the prospective Western Danish power system.

To verify the performance of the proposed method on the damping and frequency stability, a load increase disturbance and a three-phase short-circuit fault are investigated in this section. To determine how the PSS performs in low inertia systems, a comparison of system responses with PSS that was tuned well in [22], with POD and without either is investigated in the first scenario. It is worth noting that the modeled future Danish power system is a low inertia system due to high penetration of non-synchronous units, HVDC

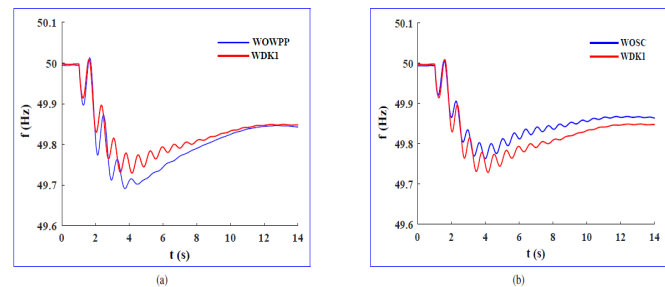

Fig. 5. Sensitivities of different components of oscillation in the prospective Western Danish power system. (a) Frequency response of WDK1 with and without WOWPP. (b) Frequency response of WDK1 with and without WOSC.

links, and a weak German grid. The Danish electricity system is divided into two non-synchronous areas: the Western Danish power system (DK1) is synchronized with the continental European system, whereas the Eastern Danish power system (DK2) is synchronized with the Nordic power system that also includes Sweden, Norway, and Finland. DK1 and DK2 are linked by an LCC-HVDC interconnection. This connection is known as the Great Belt Power Link, which has a 400 kV DC connection with a transmission capacity of 600

MW. The single-line diagram of a 400 kV DK1 renewable-based system in 2020 is shown in Fig. 3 and is used for the case study system in this paper. In this study, all synchronous generators are phased out and there are six synchronous condensers installed in the system (marked red in Fig. 3), while the SCs at FGD and KAS (SC3 and SC4) are equipped with the proposed POD controller.

#### A. Load increase disturbance

A comparison of the system responses with PSS (PSS), with POD, and without either (WO) during a load increase disturbance is intuitively shown in this scenario. Fig. 6 shows the comparative results of the system frequency, ROCOF, active power on transmission line KAS to LAG, LCC-HVDC, VSC-HVDC links, load, and the SC responses. The responses are without in the dotted black lines, with the PSS

in the dash and dotted red lines, and with the POD in the solid blue lines, respectively. From the comparative results, it can clearly be seen that with the POD controller, the system response is significantly enhanced in terms of the damping ratio and frequency stability. By comparing the system frequency in Fig. 6(a), without the POD it experiences a large and long oscillation (the dominant mode has a 0.079 damping ratio) as well as a significant frequency deviation (0.3 Hz) before obtaining a new equilibrium. In contrast, with the GA-based POD these parameters are remarkably improved by a damping ratio of 0.29 and a frequency deviation of 0.18 Hz. The frequency rapidly reaches the steady-state condition. Taking a look at the ROCOF, faster damping and quicker settling down are obviously seen in Fig. 6(b) with the POD controller.

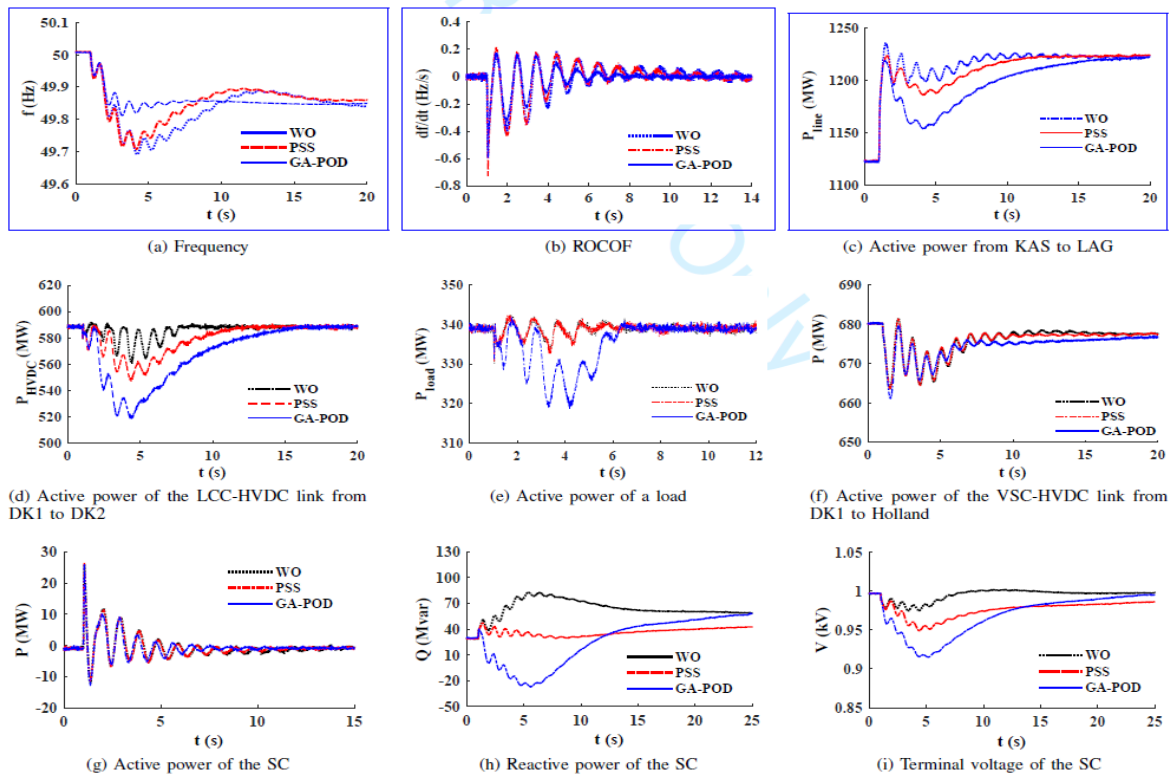

Fig. 6. Load increase scenario. (a) Frequency. (b) ROCOF. (c) Active power from KAS to LAG. (d) Active power of the LCC-HVDC link from DK1 to DK2. (e) Active power of a load. (f) Active power of the VSC-HVDC link from DK1 to Holland. (g) Active power of the SC. (h) Reactive power of the SC. (i) Terminal voltage of the SC.

The active powers on the transmission line from KAS to LAG, HVDC links, and load are controlled during the disturbance to reduce the power imbalance and damp the oscillation. As a result, the system frequency with the GA-based POD is improved in terms of the oscillation damping, frequency nadir, and settling time, as shown in Fig. 6.

An opposite trend is observed from the reactive power response of the SC during the disturbance without and with the POD controller. Instead of rapidly increasing the reactive power from 31 Mvar to approximately 83 Mvar to keep the voltage constant at the nominal value as in the WO case, the POD decreases the terminal voltage by absorbing approximately 58 Mvar reactive power (from 31 Mvar to approxi-

mately -27 Mvar) to control the power flow. Consequently, a large decrease and less oscillation are seen from the active powers on the transmission lines, HVDC links, and load with the POD controller as shown in Fig. 6.

As expected, the SC rapidly releases kinetic energy for the inertial response and quickly settles down with the POD controller as seen in Fig. 6. As a result, the power oscillation damping and frequency stability are improved during the disturbance with the POD controller. The comparison of the dominant mode information with PSS, with POD, and without either is listed in Table II, which shows a significant enhancement in terms of the frequency stability and power damping with the POD controller. The settling time and fre-

frequency nadir are improved significantly from 17 s and 49.7 Hz to 8 s and 49.82 Hz without and with the POD, respectively.

TABLE I  
BOUNDARY SETTINGS

$T_{1min}$	$T_{1max}$	$T_{2min}$	$T_{2max}$	$K_{1min}$	$K_{1max}$
0.01	10	0.01	10	0.5	50
$K_{2min}$	$K_{2max}$	$K_{3min}$	$K_{3max}$	Min	Max
0.5	12	0.05	2	-0.13	0.13

To clarify the active power decrease of the LCC-HVDC link, the rectifier is set to maintain the DC current at its set-point by controlling the firing angle. When the busbar voltage decreases, the DC current is less than its order, and the rectifier tends to reduce the firing angle, hence increasing the DC current. However, the firing angle reduction hits the minimum firing angle limit (typical  $5^\circ$ ). This results in the DC current decreasing, thereby reducing the HVDC active

power during the disturbance.

By comparison, the PSS does not handle well in the converter-based system, while the POD can further improve the frequency stability and damping ratio by absorbing more reactive power to allow for a lower voltage but still satisfy the grid code.

### B. Three-phase short-circuit fault

The POD controller is verified through a severe disturbance with a three-phase short-circuit fault and a load trip occurring simultaneously. At  $t = 1$  s, a three-phase short-circuit fault is applied on one of the feeders of the TRI bus and cleared at  $t = 1.1$  s, then the circuit breaker of the feeder suddenly disconnects the load (250 MW). Figs. 7 and 8 show the comparison of the system responses without and with the GA-based POD controller. A similar pattern is plotted in this scenario. While the uncontrolled system exhibits a severe oscillation and system collapse after approximately 4 s, the system with the POD controller performs a better damping and becomes stable after the fault.

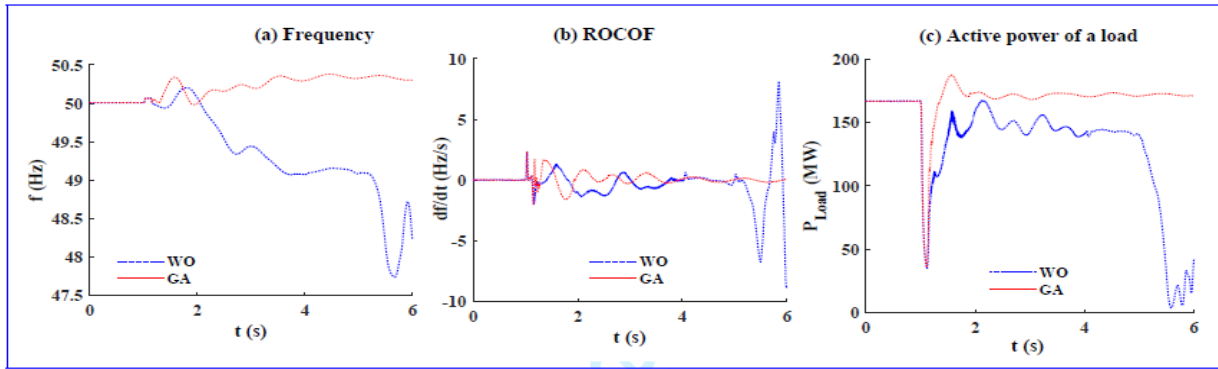

Fig. 7. Three-phase short-circuit fault scenario. (a) System frequency. (b) ROCOF. (c) Active power of the FER load.

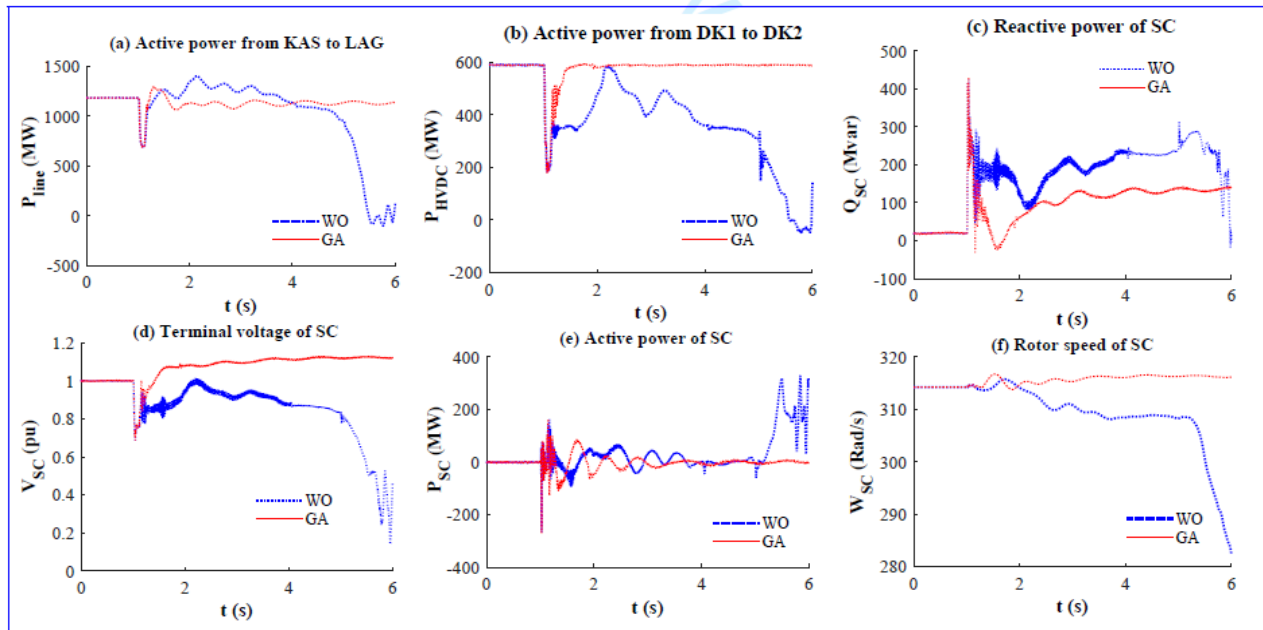

Fig. 8. Three-phase short-circuit fault scenario. (a) Active power from KAS to LAG. (b) Active power from DK1 to DK2 through HVDC connection. (c) Reactive power of the SC. (d) Terminal voltage of the SC. (e) Active power of the SC. (f) Rotor speed of the SC.



As shown in Fig. 9, for the scenario without the POD (WO), after the fault the frequencies at different substations tend to oscillate against each other, which leads to a system collapse, while they quickly become stable with the POD. Because of the asynchronism issue, the active power could not transfer from Germany to the DK2 system through the transmission line KAS to LAG, HVDC link, and load as shown in Figs. 7 and 8.

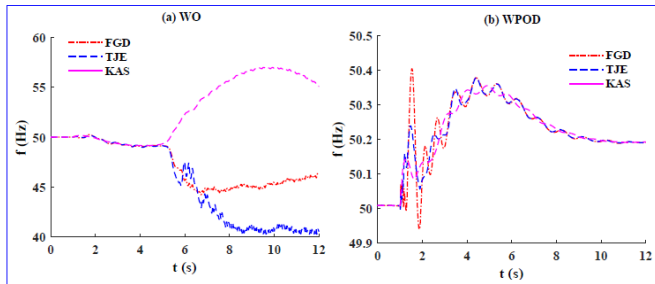

Fig. 9 Frequency responses at different substations during a three-phase short-circuit fault. (a) WO. (b) WPOD.

Instead of decreasing the reactive power to prevent the voltage surge, the POD allows terminal voltage increase within the limit range. Therefore, the transmission line, HVDC link, and load can absorb more active power to offset the power imbalance during the load trip, as can be intuitively seen in Fig. 7 and Fig. 8. This phenomenon helps the system maintaining stability after the fault.

In this scenario, the active power of the HVDC link does not significantly contribute to the power oscillation control during the disturbance with the POD. It can be explained that the busbar voltage increases, making the DC current higher than the current set-point. With the ability of firing angle control to transiently reach  $90^\circ$  in order to quickly reduce the DC current, the active power can be kept constant during the voltage increase. In contrast, the load tends to absorb more active power to counteract the power imbalance and damp the oscillation, as seen in Fig. 7.

## V. CONCLUSION

To deal with the faster frequency dynamic and oscillatory stability issues for modern power systems that introduce new stability issues and requirements for the controls. This paper proposes using SC incorporating a POD controller by controlling the terminal voltage through the reactive power regulation to improve the frequency dynamic and damp the power oscillations for low inertia systems. Prony technique is applied to extract the system oscillation characteristics from the measurement data, which benefits large-scale systems with thousands of variables. Optimization for the POD parameters with a damping ratio maximization objective is implemented by SiL simulation. Comparative results show that by controlling the terminal voltage, the power oscillation damping and frequency stability can be significantly improved by SC with the POD controller. In addition, the parameter optimization algorithm can help control designers, thereby saving time while still offering near-optimal or optimal solutions for the control parameter set compared to the

empirical tuning method.

To properly apply the POD controller to a specific grid, some conclusions should be drawn as follows:

1) Controlling the terminal voltage of the SC to change the active power should take the limitation of the transmission lines, HVDC links, and loads into consideration to set the limit values for the POD output.

2) The limits of the terminal voltage of the connected busbar may impact the components connected to the same bus of the SC (PV system, wind generator) which are sensitive to the low-voltage ride-through threshold, voltage-based protection, etc.

3) The transmission line selected for controller design should represent the paths for major oscillations in a network.

## REFERENCES

- [1] Hans Abildgaard and Nan Qin. Synchronous Condensers for reliable HVDC operation and bulk power transfer. In *2015 IEEE Power Energy Society General Meeting*, pages 1 – 9, Denver, CO, Jul 2015.
- [2] T. Van Cutsem and R. Mailhot. Validation of a fast voltage stability analysis method on the Hydro-Quebec system. *IEEE Transactions on Power Systems*, 12(1):282 – 292, Feb 1997.
- [3] I. Kamwa, J. Beland, G. Trudel, R. Grondin, C. Lafond, and D. McNabb. Wide-area monitoring and control at Hydro-Quebec: past, present and future. In *2006 IEEE Power Engineering Society General Meeting*, pages 1 – 12, Montreal, Que., Canada, Jun 2006.
- [4] P. E. Marken, J. P. Skliutas, P. Y. Sung, K. S. Kim, H. M. Kim, L. H. Sailer, and R. R. Young. New synchronous condensers for Jeju island. In *2012 IEEE Power and Energy Society General Meeting*, pages 1 – 6, San Diego, CA, USA, July 2012.
- [5] Jin woo Park, Young ho Park, and Seung il Moon. Instantaneous wind power penetration in Jeju island. In *2008 IEEE Power and Energy Society General Meeting - Conversion and Delivery of Electrical Energy in the 21st Century*, pages 1 – 7, Pittsburgh, PA, USA, Jul 2008.
- [6] P. E. Marken, M. Henderson, D. LaForest, J. Skliutas, J. Roedel, and T. Campbell. Selection of synchronous condenser technology for the Granite substation. In *IEEE PES T&D 2010*, pages 1 – 6, New Orleans, LA, USA, April 2010.
- [7] J. Skliutas, D. LaForest, R. D’Aquila, D. Derr, and E. Kronbeck. Next-generation synchronous condenser installation at the VELCO granite substation. In *2009 IEEE Power Energy Society General Meeting*, pages 1 – 8, Calgary, AB, Canada, Jul 2009.
- [8] H. T. Nguyen, G. Cesar, G. Y. Yang, C. J. Bolton, T. Rahman, and P. H. Jensen. Talega syncon - power grid support for renewable-based systems. In *2018 Western Protective Relay Conference*, pages 1 – 5, Spokane, Washington, USA, Oct. 2018.
- [9] J. P. Skliutas, R. D. Aquila, J. M. Fogarty, R. Konopinski, P. Marken, C. Schartner, and G. Zhi. Planning the future grid with synchronous condensers. In *CIGRE US National Committee 2013 Grid of the Future Symposium*, 2013.
- [10] M. Nedd, C. Booth, and K. Bell. Potential solutions to the challenges of low inertia power systems with a case study concerning synchronous condensers. In *2017 52nd International Universities Power Engineering Conference (UPEC)*, pages 1 – 6, Heraklion, Greece, Aug 2017.
- [11] Hongyang Zhang, J. P. Hasler, N. Johansson, L. Angquist, and H. P. Nee. Frequency response improvement with synchronous condenser and power electronics converters. In *2017 IEEE 3rd International Future Energy Electronics Conference and ECCE Asia (IFEEEC 2017 - ECCE Asia)*, pages 1002 – 1007, Kaohsiung, Taiwan, Jun 2017.
- [12] N. A. Masood, R. Yan, T. K. Saha, and N. Modi. Frequency response and its enhancement using synchronous condensers in presence of high wind penetration. In *2015 IEEE Power Energy Society General Meeting*, pages 1 – 5, Denver, CO, USA, July 2015.
- [13] A. Moeini and I. Kamwa. Analytical concepts for reactive power based primary frequency control in power systems. *IEEE Transactions on Power Systems*, 31(6):4217 – 4230, Nov 2016.
- [14] Z. Obaid, L. Cipcigan, L. Abraham, and et al., “Frequency control of future power systems: reviewing and evaluating challenges and new

- control methods,” *Journal of Modern Power Systems and Clean Energy*, vol. 7, pp. 9 – 25, Jan 2019.
- [15] S. Essallah, A. Bouallegue, and A. Khedher, “Integration of automatic voltage regulator and power system stabilizer: small-signal stability in DFIG-based wind farms,” *Journal of Modern Power Systems and Clean Energy*, vol. 7, p. 1115 – 1128, Sep 2019.
- [16] Y. Katsuya, Y. Mitani, and K. Tsuji, “Power system stabilization by synchronous condenser with fast excitation control,” in *PowerCon 2000. 2000 International Conference on Power System Technology. Proceedings (Cat. No.00EX409)*, vol. 3, 2000, pp. 1563 – 1568.
- [17] H. T. Nguyen, G. Yang, A. H. Nielsen, and P. H. Jensen, “Hardware and software-in-the-loop simulation for parameterizing the model and control of synchronous condensers,” *IEEE Transactions on Sustainable Energy*, vol. 10, no. 3, pp. 1593 – 1602, 2019.
- [18] IEEE Task Force on Load Representation for Dynamic Performance. Standard load models for power flow and dynamic performance simulation. *IEEE Transactions on Power Systems*, 10(3): 1302 – 1313, Aug 1995.
- [19] Y. Chen. Replacing a PID controller by a lag-lead compensator for a robot - A frequency response approach. *IEEE Transactions on Robotics and Automation*, 5(2):174 – 182, April 1989.
- [20] P. Kundur. *Power System Stability and Control*. New York: McGraw-Hill, 1994.
- [21] A. Murdoch, S. Venkataraman, R. A. Lawson, and W. R. Pearson. Integral of accelerating power type PSS. I. Theory, design, and tuning methodology. *IEEE Transactions on Energy Conversion*, 14(4):1658 – 1663, Dec 1999.
- [22] I. Kamwa, R. Grondin, and G. Trudel. IEEE PSS2B versus PSS4B: the limits of performance of modern power system stabilizers. *IEEE Transactions on Power Systems*, 20(2):903 – 915, May 2005.
- [23] L. H. Hassan, M. Moghavvemi, H. A. F. Almurib, and K. M. Muttaqi. A coordinated design of pss and upfc-based stabilizer using genetic algorithm. *IEEE Transactions on Industry Applications*, 50(5):2957 – 2966, Sep. 2014.
- [24] W. Moreti da Rosa, P. Rossoni, J. C. Teixeira, E. A. Belati, and P. Teixeira Leite Asano. Optimal allocation of capacitor banks using genetic algorithm and sensitivity analysis. *IEEE Latin America Transactions*, 14(8):3702 – 3707, Aug 2016.
- [25] L. Scharf. *Statistical Signal Processing: Detection, Estimation, and Time Series Analysis*. New York: Addison-Wesley, 1991.
- [26] X. Xia, C. Li, and W. Ni. Dominant low-frequency oscillation modes tracking and parameter optimisation of electrical power system using modified Prony method. *IET Generation, Transmission Distribution*, 11(17):4358 – 4364, 2017.
- [27] H. T. Nguyen, G. Y. Yang, A. H. Nielsen, and P. H. Jensen. Combination of synchronous condenser and synthetic inertia for frequency stability enhancement in low-inertia systems. *IEEE Transactions on Sustainable Energy*, 10(3):997 – 1005, July 2019.
- Taiwan, China, in 2014, and Technical University of Denmark (DTU), Lyngby, Denmark, in 2018, respectively. In 2017, she was a Visiting Scholar at the Center Energy Research, University of California San Diego, San Diego, USA. Currently, she is working as a Postdoc at the Center for Electric Power and Energy at DTU. Her research interests include power system operation and control, frequency stability and control, and renewable energy integration, real-time co-simulation, distributed power-hardware-in-the-loop simulation.

**Guangya Yang** received Ph.D. degree in 2008 from the University of Queensland, Queensland, Australia, in the field of electrical power systems. Currently, he is Senior Power System Engineer with Ørsted and Senior Scientist with Technical University of Denmark, Lyngby, Denmark. Since 2009, he has been developing and leading many industrial collaborative projects in Denmark. He is editorial board member of IEEE Transactions on Sustainable Energy, IEEE Transactions on Power Delivery, IEEE Access, and Journal of Modern Power System and Clean Energy. His research experience ranges from power system security, offshore wind power system design and control, and transactive energy applied to integrating distributed energy resources. His research focus is currently on the low inertia system stability and control with respect to the integration of offshore wind power systems.

**Arne Hejde Nielsen** is an Associate Professor at the Centre for Electric Power and Energy, Department of Electrical Engineering, Technical University of Denmark, Lyngby, Denmark. He has 30-year experience in electric power engineering; the first years were from ASEA AB, Central Research and Development Department, Sweden, with focus on measurement technology and motor design and control. Over the past decade, his focus has been on electric power systems, especially on the implementation of renewable energy sources in the power system.

**Peter Højgaard Jensen** is a System Specialist at Siemens A/S. He received the M.Sc. degree in electrical engineering from the Technical University of Denmark, Lyngby, Denmark, in 1979. He has 34 years' experience from Danish Power Plants in maintenance, operation, management, engineering, power plant erection and commissioning. Five years in Siemens have been used for developing new control concept for synchronous condensers and commissioning of 13 synchronous condensers (175-270 Mvar) in Denmark, Norway, Texas and California.

**Bikash Pal** received B.E.E. degree (with honors) from Jadavpur University, Calcutta, India, the M.E. degree from the Indian Institute of Science, Bangalore, India, and the Ph.D. degree from Imperial College London, London, UK, in 1990, 1992, and 1999, respectively, all in electrical engineering. Currently, he is a Professor in the Department of Electrical and Electronic Engineering, Imperial College London. He is Vice President Publications, IEEE Power & Energy Society. He was Editor-in-Chief of IEEE Transactions on Sustainable Energy (2012-2017) and Editor-in-Chief of IET Generation, Transmission and Distribution (2005-2012) and is a Fellow of IEEE for his contribution to power system stability and control. His current research interests include renewable energy modelling and control, state estimation, and power system dynamics.

**Ha Thi Nguyen** received the B.Sc., M.Sc. and Ph.D. degrees in electric power systems from University of Science and Technology - the University of Danang, Danang, Vietnam, in 2010, National Cheng Kung University,