



Nordic Industrial IoT Roadmap: Research And Innovation For The Green Transition

Pop, Paul; Törngren, Martin

Publication date:
2021

Document Version
Publisher's PDF, also known as Version of record

[Link back to DTU Orbit](#)

Citation (APA):
Pop, P., & Törngren, M. (Eds.) (2021). *Nordic Industrial IoT Roadmap: Research And Innovation For The Green Transition*.

General rights

Copyright and moral rights for the publications made accessible in the public portal are retained by the authors and/or other copyright owners and it is a condition of accessing publications that users recognise and abide by the legal requirements associated with these rights.

- Users may download and print one copy of any publication from the public portal for the purpose of private study or research.
- You may not further distribute the material or use it for any profit-making activity or commercial gain
- You may freely distribute the URL identifying the publication in the public portal

If you believe that this document breaches copyright please contact us providing details, and we will remove access to the work immediately and investigate your claim.

NORDIC INDUSTRIAL IOT ROADMAP

RESEARCH AND INNOVATION FOR THE GREEN TRANSITION

*This roadmap was
prepared by the Nordic
University Hub on
Industrial IoT, see
nordic-iot.org*

*Funding: NordForsk
grant agreement no.
86220*

Editors:

*Prof. Paul Pop
Technical University of
Denmark*

*Prof. Martin Törngren
Royal Institute of
Technology, Sweden*

March 15th, 2021

Table of Contents

page

5

*Setting the scene,
Nordic strengths*

page

15

*Related roadmaps
& agendas*

page

24

*State of play
in the Nordics*

page

34

Application areas

page

40

Technological paradigms

page

47

Research priorities

page

65

Acknowledgements

Executive Summary

The Nordic Industrial IoT (IIoT) Roadmap has been developed by five Nordic universities to complement existing roadmaps and research agendas, such as the European initiatives on Green Deal, Smart Everything Anywhere, and Autonomous systems—see the section “Related roadmaps & agendas”.

A long-term focus on sustainability has provided the Nordic countries with significant advantages. For example, the CO₂ intensity (gCO₂/KWh) of power and district heating production amounts to only 14% of the EU25 average and transport’s total energy use decreased by over 20% compared with 2000, despite a 70% increase in overall passenger and freight activity.

Many of these results have been achieved by a long-term focus on digitalization—in fact the four Nordic countries are ranked on the top four places in EU’s 2020 “Digital Economy and Society Index”. Thus, the Nordic countries are good at both sustainability and digitalization!

The Nordic countries are also strong in trustworthiness and cyber-physical systems. We believe that there is now a unique opportunity to leverage these competences (trustworthiness, digitalization—AI, 5G, cloud and edge computing, and the IoT—and CPS) to enable and promote sustainability and a circular economy. However, this requires a much stronger emphasis on multidisciplinary research, networking and testbeds to establish the collaboration and new methodologies and technologies needed for a human-centered and sustainable future.

The Nordic IIoT Roadmap outlines several research areas where progress is needed to enable these directions. Examples include: Automated driving for sustainable mobility & transport, Self-powering systems for IoT & energy-efficient sensor networks, Safety, security, and privacy by design, Reduction of the energy consumption of HPC and datacenters and wearables for healthcare and wellbeing.

Several private and governmental R&D programs are supporting this Nordic long-term transition, with contributions of more than 100 MEUR per year.

The Nordic network demonstrates the value of multidisciplinary collaboration to stimulate research that deals with sustainability challenges and leverages digitalization to provide solutions.

However, the complexity of the challenges and the resulting interconnected & smart cyber-physical systems-of-systems is growing, involving more stakeholders, and forming new innovation ecosystems, necessitating further action.

To maintain and strengthen the Nordic leading position, we recommend establishing a joint Nordic Center doing research in trustworthy methodologies for the implementation of sustainable IIoT, and specific actions for training the next generation of students in both digitalization and the green transition.

Recommendations

Successfully mastering trustworthy IIoT provides many benefits for the Nordic countries, as we highlight in the "Setting the scene" and "State of play" sections. IIoT is a key enabling technology for the green transition, bringing together several technological paradigms, from smart electronic components, 5G technologies, to AI and Edge Computing.

Our recommendations are:

- To maintain and strengthen the Nordic leading position in trustworthy digitalization. A general enabler for this leadership has been the long-term focus on security and trustworthiness of the IIoT systems. However, further success and industrialization will require a strong emphasis on collaboration, and synergies between the currently scattered national competences. We therefore recommend establishing a joint Nordic Center doing research in trustworthy methodologies for the implementation of sustainable IIoT.

- To prioritize R&D with increased focus on IIoT solutions facilitating traceability, reparability, durability and recyclability, with a specific goal to establish the required multidisciplinary collaborations. This focus is motivated by the green transition, which will require a framework for green growth and the circular economy, enhanced by digital technologies.
- To train the next generation of students in both digitalization and the green transition, the Nordic universities should focus on sharing advanced course modules that are easily integrated into the current curricula.

Setting the scene

Currently, the Nordic region is the most sustainable region globally

Roadmap: Scope and Limitations

Green transitions

Nordic decarbonization

Nordic research and innovation

The digitalized Nordic countries

How can digitalization, IoT and CPS support a circular economy?

Large Nordic initiatives

Roadmap

Scope and limitations

Humanity is facing many challenges, from climate warming to pandemics

The Nordics are well-positioned to address these challenges via research and innovation

Scope

Humanity is facing a pandemic, with side-effects, including recession and starvation, that go beyond the direct pandemic effects. Simultaneously, global warming, and several other environmental and sustainability factors pose even larger challenges in the longer term.

At the same time, we are actors in a technical paradigm shift with its own opportunities and challenges. The Nordic countries are good at sustainability and digitalization!

Our unique touch and opportunity is to:

Exploit digitalization and cyber-physical systems to counter sustainability challenges and drive a circular economy.

Use digital technologies such as AI, 5G, cloud and edge computing and IoT, which are critical enablers for reaching the sustainability goals.

Paradigm shifts

Indications of a technical paradigm shift with many perspectives and names—several technical fronts and advancements, including:

- Edge/Fog (2012)
- Industry 4.0 (2010)
- DevOps (2009)
- Cyber-Physical Systems (2006)
- Internet of things (1999)
- Ubiquitous computing (1988)
- Artificial Intelligence (1956)

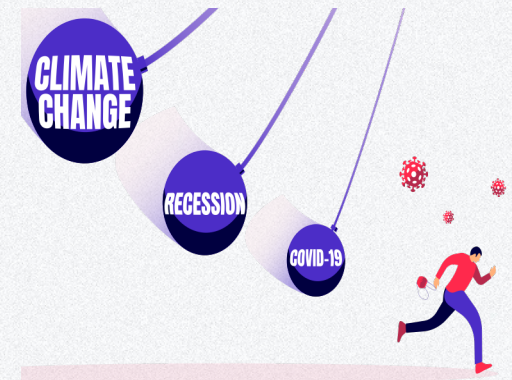

Green transitions



Other initiatives:

The Japanese Green Recovery

US Green New Deal

China: a carbon-neutral state by 2060

European Green Deal

European Green Deal: The European Commission's strategy for implementing the United Nation's 2030 Agenda and the sustainable development goals. Similar efforts are ongoing on other continents.

Aim: To be the first climate-neutral continent by 2050!

A roadmap for making the EU's economy sustainable by turning climate and environmental challenges into opportunities across all policy areas.

Achieving the current 2030 climate and energy targets is estimated to require €260 billion of additional annual investment, representing about 1.5% of 2018 GDP.

At least 25% of the EU's long-term budget should be dedicated to climate action. It covers all sectors of the economy, notably transport, energy, agriculture, buildings, and industries such as steel, cement, ICT, textiles and chemicals.

Strong track record in Europe

The EU already has a strong track record in reducing its emissions of greenhouse gases while maintaining economic growth. Emissions in 2018 were 23% lower than in 1990 while the Union's GDP grew by 61%.

...and in the Nordic countries

A high share of renewable energy ranging from 32% to 73% in 2016, relative to the EU28 average share of 17%. A high proportion of electric vehicles, e.g., 50% market share in Norway in 2020.

Transport's total energy use decreased by over 20% compared with 2000, despite a 70% increase in overall passenger and freight activity.

Emissions from heating residences in the rather cold Nordic region amounts to just 0.2t CO₂ per capita, compared to an average of 0.8t CO₂ for OECD Europe.

Nordic decarbonization

An efficient Nordic power market has been key to the integration of large renewables, where the relative CO₂ intensity has settled at around 60 gCO₂/kwh compared to EU25 of 447 gCO₂/kwh (2013).

Nordic decarbonization—well underway

Despite economic growth, the Nordics have in recent years managed to decouple energy use and CO₂ emission intensity. The Nordic CO₂ emission intensity from power and district heat production has, for example, been reduced over the past decades, starting from an already low level (60 gCO₂/kwh in 2013 compared to EU25 of 447 gCO₂/kwh).

The figure below shows the Nordic CO₂ emissions vs. Global emissions. In the Nordic countries the emissions from power and district heating amount to about 1/3 of all emissions. The remaining 2/3 is from industry and transport, etc. Hence the highest CO₂ impact from IIoT would be achieved by targeting industry and transport.

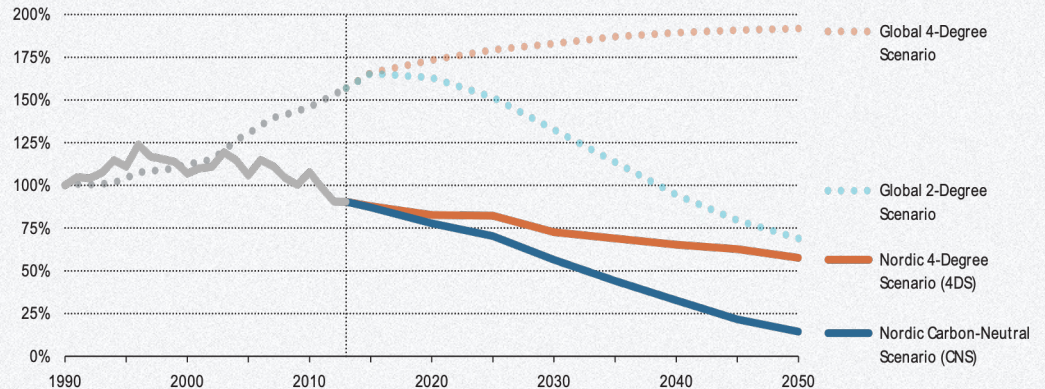

Nordic research and innovation



Unique positioning of the Nordic countries

Strong awareness and a drive for sustainability – however, still room for further digitalization (providing an opportunity).

Strong on digitalization in a physical world!

Emphasis on “trustworthiness” of connected cyber-physical systems of systems including privacy, integrity, security, safety, availability and explainability.

A call for cross-disciplinary and multi-stakeholder collaboration, open data, testbeds, systems thinking—with socio-technical considerations.

In the 2016 EC Innovation Scoreboard, the Nordic Region was the most innovative in Europe, not least in terms of clean technologies.

Roadmap motivation

Many relevant roadmaps have been proposed, (see the “Related roadmaps & agendas” section), however, there is still a gap between sustainability and digitalization in a physical world.

Nordic strengths in this area motivate a dedicated roadmap effort

This will complement current efforts, such as the European Green Deal, Smart Everything Everywhere, and Autonomous systems.

Opportunity: Leverage digitalization to support a circular economy.

The digitalized Nordic countries

The digital maturity of our societies is high

The Nordic countries top the European Commission's digital index of 2020. Finland is the EU's best-performing country in digitalization, while Sweden ranks second, Norway third and Denmark fourth.

Each country is assessed on five dimensions: 1 Connectivity (access to and use of broadband), 2 Human capital (citizens' digital skills/the proportion of ICT specialists among professionals), 3 Use of internet services (citizens' use of the Internet, online activities), 4 Integration of digital technology (e-commerce, cloud services, big data), 5 Digital public services (eGovernment, e-prescriptions, open data). The index combines 34 indicators and uses a weighting system to rank each country based on its digital performance.

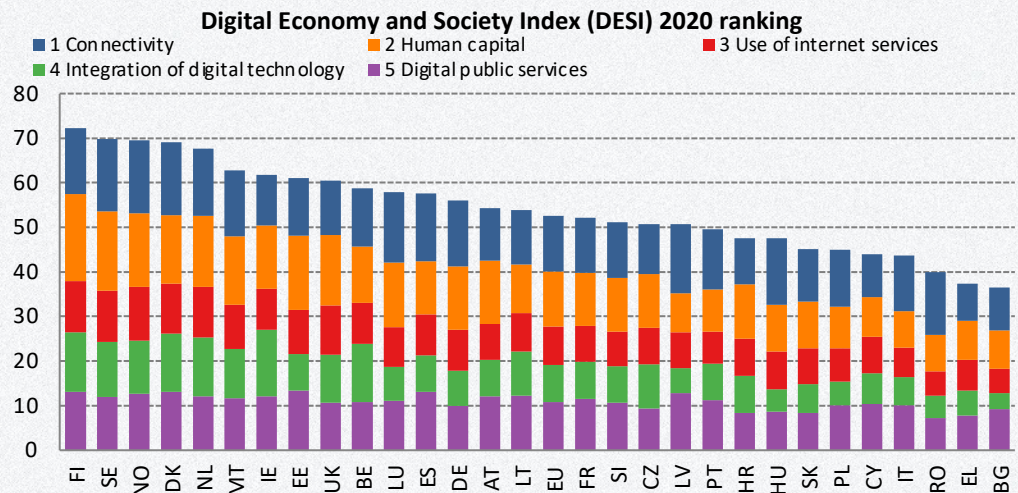

How can digitalization, IoT and CPS support a circular economy?

Life-long education and training, systems thinking, collaboration and communication



Circular economy: "An economy that is restorative and regenerative by design"

To move beyond the take-make-dispose industrial model we need a paradigm shift in a specialized global world!

Three important principles are to :

- (1) Regenerate natural systems,
- (2) Design out waste and pollution,
- (3) Keep products and materials in use.

We need a new mindset: Thinking of "value flows"—eliminating waste. Keywords are: Maintain, prolong, reuse, redistribute, refurbish, remanufacture, recycle.

Support from digitalization, Industrial IoT & CPS

These technologies facilitate activities such as:

Identification, tracing, monitoring, and prediction;

Reuse, recycling, upgrading, downgrading and maintenance;

Establishment of a service-based business model.

Individualized tailored production of spare parts.

Development of modular, upgradable and reconfigurable architectures.

Digitalization technologies that themselves are designed for circularity, to improving electronic waste recycling, and to be trustworthy!

Large Nordic initiatives

~100 MEUR/year



Trustworthy Edge-Computing Systems and Applications (SE)

A Swedish national research center (Vinnova), where KTH and industrial partners develop foundations for safe, secure and predictable industrial edge computing systems.



Finnish Center for Artificial Intelligence (FI)

A Finnish flagship network, where Aalto has a central role, working on the Internet of Things, Autonomous Systems, Telecom Networks.



Wallenberg AI, Autonomous Sys. & Software Program (SE)

The largest Swedish research program, involving Finance and Business Analytics, Mobile Communications, Transport Systems and Smart Manufacturing.

Large Nordic initiatives, cont.

digital futures

KTH Digital Futures (SE)

DF is a cross-disciplinary research center, established by KTH, Stockholm University and RISE, that explores and develops digital technologies, bringing solutions to societal and industrial challenges.

DIREC

Digital Research Centre Denmark

National Centre for Research in Digital Technologies (DK)

The National Centre for Research in Digital Technologies is a consortium involving the major Danish computer science departments, with the aims of expanding Denmark's capacity for research, innovation and education in digital technologies.

AUTOSHIP

SFI Autoship (NO)

SFI Autoship is a research-based innovation center that will contribute to the development of autonomous ships for safe and sustainable operations. The center has more than 20 partners from the Norwegian maritime industry.

Large Nordic initiatives, cont.



ELLIIT (SE)

ELLIIT is a Swedish strategic research environment on information technology, mobile communications, and digitalization; established by Linköping University, Lund University, Halmstad University and Blekinge Institute of Technology. ELLIIT constitutes a platform for both fundamental and applied research, and for cross-fertilization between disciplines and between academic researchers and industry experts.



Smart Mobility (FI)

Smart Mobility is a Finnish program (2018-22) offering innovation funding, market intelligence, networking and internationalization services, targeted at companies, research organizations, municipalities and cities, including service, ICT and manufacturing industries. Its priority areas include Autonomous and secure industrial logistics, and Smooth urban mobility services (MaaS).

Green Platform Initiative

Green Platform Initiative (NO)

The Green Platform Initiative is a new Norwegian scheme that provides funding for enterprises and research organizations engaged in the innovation-driven green transition. Supported projects should combine knowledge production, technology development, piloting, business development, commercialization and scaling of green transition processes, products and services.

Related roadmaps & agendas

Many roadmaps already show the political desired direction

*AIOTI: Alliance for Internet
of Things Innovation*

*EFFRA: Factories 4.0
and Beyond*

Platforms4CPS

ECS SRA 2020

*European Partnership
on Artificial Intelligence,
Data and Robotics*

CREATE-IoT

*IIoT - Smart Networks
and Services*

NIST Cybersecurity

AIOTI: Alliance for Internet of Things Innovation



Initiated by the European Commission in 2015 to strengthen the dialogue and interaction among IoT players in Europe, to contribute to the creation of a dynamic European IoT ecosystem and accelerate the take-up of IoT

Research and innovation, eco-systems, policy, standards and distributed ledger technologies, as well as cross-disciplinary activities focused on key IoT issues.

14 founding member organizations,
100+ regular members

Priorities for 2019-2024

Support for a human-centric approach ensuring safety, security, privacy and trust.

Leverage IoT data, enable cross-sectoral "data marketplaces".

Establish a cybersecurity strategy for safeguarding IoT technology and applications.

Digitalization of EU industries to follow market and societal needs.

IoT for energy efficiency, climate-change, carbon-neutral smart cities, security of food supply and healthy water.

Constant dialogue between different actors: EC, member states, industry on IoT policy, regulation, R&I, standardization.

EFFRA: Factories 4.0 and Beyond



Scope

Recommendations from the European Factories of the Future Research Association (EFFRA) for the Work Programme 18-19-20 of the Factories of the Future (FoF) public-private partnership (PPP) under Horizon 2020.

The main recommendations are to focus on:

Digital Factory Modeling and Simulation;

Multiple Source (Big) Data Mining and Real Time Analysis at the Factory and Supply Chain/Network Levels;

CPS: Integration with physical legacy machines in factories;

Security, Privacy and Liability – Cybersecurity and Industrial Safety;

Digital Platform Interoperability.

Key priorities

The key priorities build heavily on the vision laid out by the “Factories of the Future 2020” (FoF2020) roadmap:

Agile value networks: Lot-size one—distributed manufacturing;

Excellence in manufacturing: Advanced manufacturing processes and services for zero-defect and innovative processes and products;

The human factor: Developing Human competences in synergy with technological progress;

Sustainable value networks: Manufacturing driving the circular economy;

Interoperable digital manufacturing platforms: supporting an eco-system of manufacturing services.

Platforms4CPS



Scope

Platforms4CPS was a Coordination & Support Action in the area of Smart Cyber-Physical Systems. The project aimed at implementing strategic actions for future CPS through roadmaps, impact multiplications and constituency building.

The main recommendations are to focus on:

Trustworthy CPS for Autonomous and Smart AI;

Supporting research actions on edge computing algorithms and architectures;

Addressing the complex interactions between humans and systems with increasing autonomous functionality.

Key priorities

Platforms4CPS performed an analysis of opportunities and roadblocks across the transport, manufacturing, energy and health sectors. Increased connectivity and automation are drivers in all domains. In the transport sector in particular there are opportunities in providing systems for vehicles but also for the supporting infrastructure.

There is a need for platform building to overcome fragmentation of the European CPS landscape, as there are currently a multitude of platforms and initiatives (>100 identified).

To overcome this, Platforms4CPS proposes to create an exchange portal (PlatForum) that helps clarify terminology, addresses foundations of CPS engineering, provides an overview of roadmaps, and acts as a repository of CPS building blocks.

ECS Strategic Research Agenda 2021 (SRA)

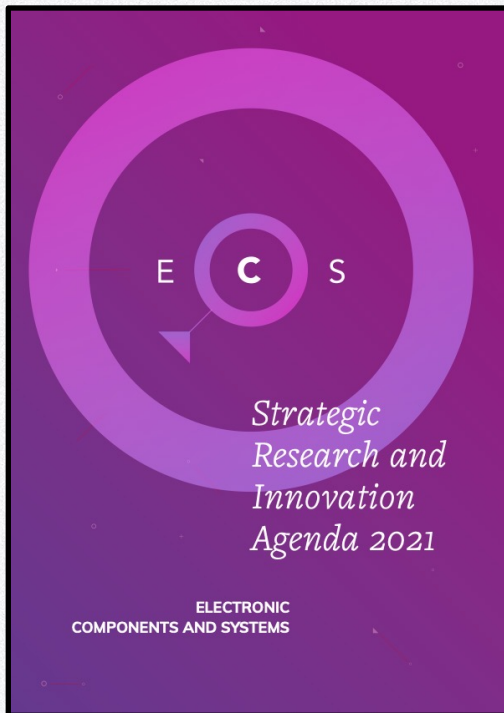

Scope

The ECS-SRA 2021 is endorsed by the three Industry Associations AENEAS, ARTEMIS and EPoSS. The 2021 edition of the joint Electronics Components and Systems (ECS) Strategic Research Agenda (SRA) identifies the strategic priorities and technical pathways to enable European industry to become stronger and more competitive.

The main common objectives for the ECS community are:

Boost industrial competitiveness through interdisciplinary technology innovations;
Ensure EU sovereignty through secure, safe and reliable ECS supporting key European application domains;
Establish and strengthen sustainable and resilient ECS value chains supporting the Green Deal; and to
Unleash the full potential of intelligent and autonomous ECS-based systems for the European digital era.

The foundational technology layers addressed are:

Process technologies, equipment, materials and manufacturing;
Components, modules and systems integration;
Embedded software and beyond; and
System of systems.

The cross-sectional technologies are:

Artificial Intelligence, Edge Computing and Advanced Control;
Connectivity;
Architecture and Design: Methods and Tools; and
Quality, Reliability, Safety and Cybersecurity.

The key application areas are:

Mobility; Energy; Digital industry;
Health and wellbeing; Agrifood and natural resources; and Digital Society.

Strategic Research, Innovation and Deployment Agenda for the AI, Data and Robotics Partnership

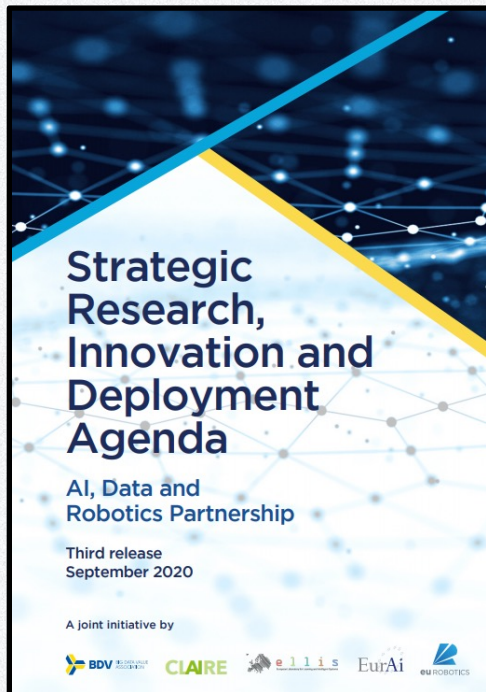

Scope

The vision of this PPP is to boost European industrial competitiveness and lead the world in developing and deploying value-driven trustworthy AI based on European fundamental rights, principles and values. It is a joint action by the BDVA, CLAIR, EurAI and the euRobotics PPP.

The main recommendations are to focus on:

European Fundamental Rights, Principles and Values;

Policy, Regulation, Certification and Standards;

Sensing, Measurement and Perception;

Continuous and Integrated Knowledge;

Trustworthy Hybrid Decision Making;

Physical and Human action and Interaction;

Systems, Methodologies and Hardware.

Key priorities

Leveraging the combined resources and expertise of the European members to increase competitiveness in important industrial and business sectors and accelerate transformation;

Mobilizing industrial investments by connecting organizations that define and implement AI based systems;

Leading AI-driven transformation of value chains in Europe;

Acting as the European focal point for exchange and coordination of AI, Data and Robotics innovation communities;

Setting out European best practices on AI, with emphasis on privacy, data, ethics and human interaction;

Developing trust in AI through application of trustworthy design, validation and certification;

Ensuring that all stakeholders along the value chain have the necessary understanding and skills.

CREATE-IoT

Cross fErtilisation through
AlignmenT, synchronisation and
Exchanges for IoT



Scope

The objectives of the CREATE-IoT project are to stimulate collaboration between IoT initiatives, foster the take up of IoT in Europe and support the development and growth of IoT ecosystems based on open technologies and platforms.

The main recommendations are to focus on:

Establishing a common vocabulary of terms and definitions;

Favoring interoperability by choosing common standards up to application level;

Promoting collaboration between Standards Development Organizations;

Making coordinated contributions to standards;

Validating and improving standards via plugtests.

Key priorities

CREATE-IoT identifies a conceptual structure that aims to organise and clarify the collective principles, functions, definitions, requirements and practices, created through the technical expertise of stakeholders within five IoT European Large-Scale Pilots:

ACTIVAGE (smart living environments for aging well)

AUTOPILOT (autonomous vehicles in a connected environment)

IoF2020 (smart farming and food security)

MONICA (wearables for smart ecosystems)

SINCRONICITY (smart cities)

IIoT— Smart Networks and Services



Scope

Smart IoT networks and services, for example in the form of Smart Cities and Smart Grids, offer new opportunities to use collected sensor data to manage traffic, infrastructure, reduce pollution and generally keep citizens safe.

The main recommendations are to focus on:

Network challenges related to deployment of smart networks. Proper choice of communication technology can be vital to assure a reliable network and service;

Security and big data management. These are important areas, to keep critical infrastructure and GDPR collected information safe;

Investigation of how large amounts of data can be utilized in the most effective way, possibly with the use of AI and advanced algorithms.

Key priorities

Assuring reliable and secure networks and services;

Optimization of big data collection and handling in smart networks;

Carefully analyzing current and future needs in a smart network to be able to make qualified infrastructural and technological choices when establishing and maintaining a smart network;

Analyzing needs and potential added value for cities and smart grids in general, in order to prioritize and ensure that technological needs are met and are able to support the services.

NIST Cybersecurity

Scope

The US National Institute of Standards and Technology (NIST) have provided a framework for improving critical infrastructure Cybersecurity.

The main recommendations are to focus on:

Functions to organize basic cybersecurity activities at their highest level. These Functions are Identify, Protect, Detect, Respond, and Recover;

The functions aid an organization in expressing its management of cybersecurity risk by organizing information, enabling risk management decisions, addressing threats, and improving by learning from previous activities.

Key priorities

Developing an organizational understanding of how to manage cybersecurity risks to systems, people, assets, data, and capabilities;

Developing and implementing appropriate safeguards to ensure delivery of critical services;

Developing and implementing appropriate activities to identify the occurrence of a cybersecurity event;

Developing and implementing appropriate activities to take action regarding a detected cybersecurity incident;

Developing and implementing appropriate activities to maintain plans for resilience and to restore any capabilities or services that were impaired due to a cybersecurity incident.



State of play

All four Nordic countries are taking the lead in both knowledge building and green industrialization

Denmark

Danfoss Drives A/S

Finland

Maillefer Extrusion Oy

Norway

Bane NOR

Sweden

*Atlas Copco Industrial
Technique AB*

*Other major Nordic IIoT
implementations*

Denmark

Denmark is at the forefront of Smart Energy and Smart Cities and a leading tech hub in AI, IoT, and big data

Denmark is among the five leading countries, performing well in all the major technology enablers: broadband, cloud, AI and IoT (Global Connectivity Index). Danish companies are confident about the potential of IoT, with the nation's advanced infrastructure able to support IoT rollout. Denmark's IT infrastructure achieves maximum scores in ten indicators, which have been assessed in 79 leading industrial countries.

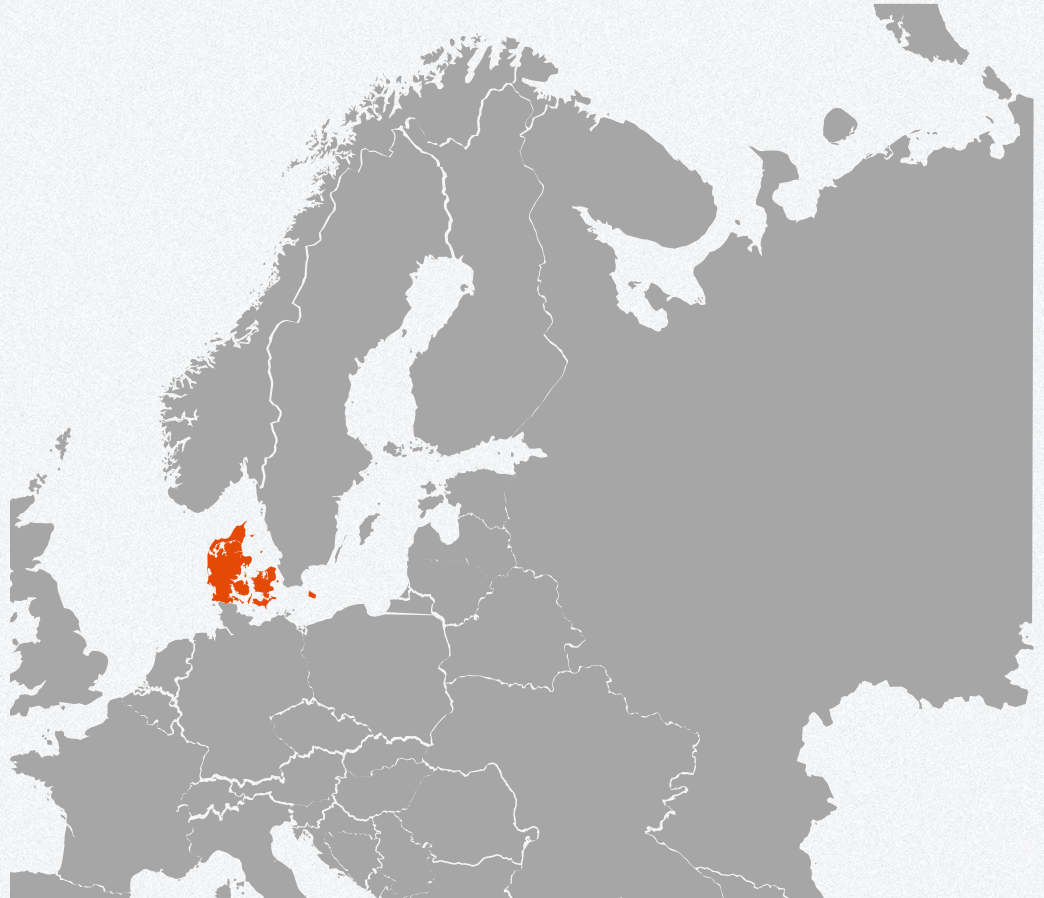

Danfoss Drives A/S

Supplier of Automation Systems



Danfoss Drives, <http://bit.ly/3eoQMRN>
Photo: Danfoss – Our Businesses – Drives, <http://bit.ly/3eoQMRN>

Dr. Juha Kuusela, Software Advisor

For 50 years, Danfoss Drives has been a global leader in the variable speed control of electric motors, with the world's largest installed base of variable speed drives. Danfoss' electric drives are used to control the speed, torque and position of different electrical motors with real-time software that resides on heterogeneous safety-critical embedded systems controlling the power electronic circuits.

Electric drives are pervasive in industrial installations and are used in many markets, including the automotive, buildings, energy, food and beverage, industry, marine and offshore, mobile hydraulics, refrigeration and air conditioning, water, and wastewater industries..

“Danfoss Drives are working on using Edge and AI Drives as edge devices to bootstrap the data economy.”

The major direct business benefit comes from the ability to instrument even legacy systems by using the drives as the data source. Edge analytics will help in off-loading the network and extend the IoT solutions market. Edge node capability will increase the value of Danfoss' products leading to increased sales. We are planning to develop new digital services around predictive maintenance and analytics, expected to grow at 20% CAGR.

Finland

Finland is ranked second in ICT and digitalization worldwide according to the World Economic Forum

The government recognizes the importance of Industrial IoT and intends to make Finland the "Silicon Valley of the Industrial Internet", leading to job creation (48,000), increase in production and service investment (€56bn turnover) by 2023. Among Finland's strengths are high employee education and competence and the innovation system.



Maillefer Extrusion Oy



Maillefer Extrusion Oy, <https://mailefer.net>
Photo: Janne Harjuhahto, Maillefer Blog, <http://bit.ly/3uRwz4U>

Mikko Lahti, Director, R&D

Maillefer is a global leader in wire, cable, pipe and tube production technologies. Maillefer offers over 50 technologies and the widest services portfolio in the industry to cover nearly 20 applications. Maillefer provides complete extrusion solutions serving both wire & cable and pipe & tube manufacturers worldwide. Maillefer delivers manufacturing equipment from individual components to complete production units and factories.

At Maillefer, we constantly pursue new ways to improve our products and solutions to better serve our customers. Artificial intelligence, Edge-computing and Industrial Internet together with Industry 4.0 are main domains we actively work with. We have long worked with software products and process data, and recently we have started employing data science methods together with deep learning to create completely new products and services. We have launched our first AI based products, one for real-time quality control of high-voltage cable production lines, and another for on-line process optimization of fiber optics cable production. Currently, we are planning new predictive maintenance products and services.

“We see that our future is in smart products and services of the Industrial Internet era. Research and development of new tools and methods requires joint efforts both from industry and academia.”

Norway

Norway is fourth in ICT and digitalization, worldwide

Norway has a significant presence in developments of wireless technologies and software for Industrial IoT. Digitalization is considered essential for competitive and sustainable production in Norway via development of new components, their production, new business models, reshoring and retaining existing production. In the marine and maritime domains, the shift towards Industrial IoT and the related connectivity will be a prerequisite for autonomous ships and other autonomous marine operations.



Bane NOR, Norway

Kenneth Andersen, Smart Maintenance, Railway Services, Digitization and Technology

Bane NOR's social mission is to develop, build, operate and manage the national railway network. Through a safe, customer-friendly, accessible and efficient railway infrastructure we lay the foundation for traffic growth through the major hubs. Almost 4,400 dedicated employees manage, operate and maintain 4,200 km of tracks with 1900 daily routes and 200,000 people transported a day. To sustain ongoing growth, all railway lines in Norway will be controlled remotely by 2030 when the ERTMS – the biggest digitalization project in Norway – is completed. This will complete the necessary renewal of old signaling technology and provides passengers an even safer, more reliable railway with greater capacity. This will be supported by a 5,000 km-long fiber network along the rails that will form the backbone of the digital railway.



“Ensuring safety is by far the most important reason for maintaining our rail systems!”

Good maintenance is also a prerequisite for punctual traffic. Faults and defects that are detected early can be remedied before causing service stoppages. This is also the reason why Bane NOR is starting to use new digital solutions for monitoring important track components, such as railway switches. Close cooperation with NTNU and various EU-initiatives as DESTinationRAIL and Nordic University Hub on Industrial IoT (HI2OT) resulted in the RailCheck system now used as a permanent testbed for monitoring and research on railway switches. Systems such as this underpin future progress in data driven prognoses and health management, and can contribute to the transition from preventive to predictive maintenance.

Sweden

Sweden is ranked number three in World Economic Forum's index in ICT and digitalization

Sweden plans to become a leading nation in several industries through joint advanced development and use of IoT. The trends towards a "digitalization" of the industry are supported in several strategic research agendas, including the Swedish Manufacturing of the future, by the innovation program Process-industrial IT and Automation, and by Vinnova's (Sweden's innovation agency) strategic innovation program for Production2030.

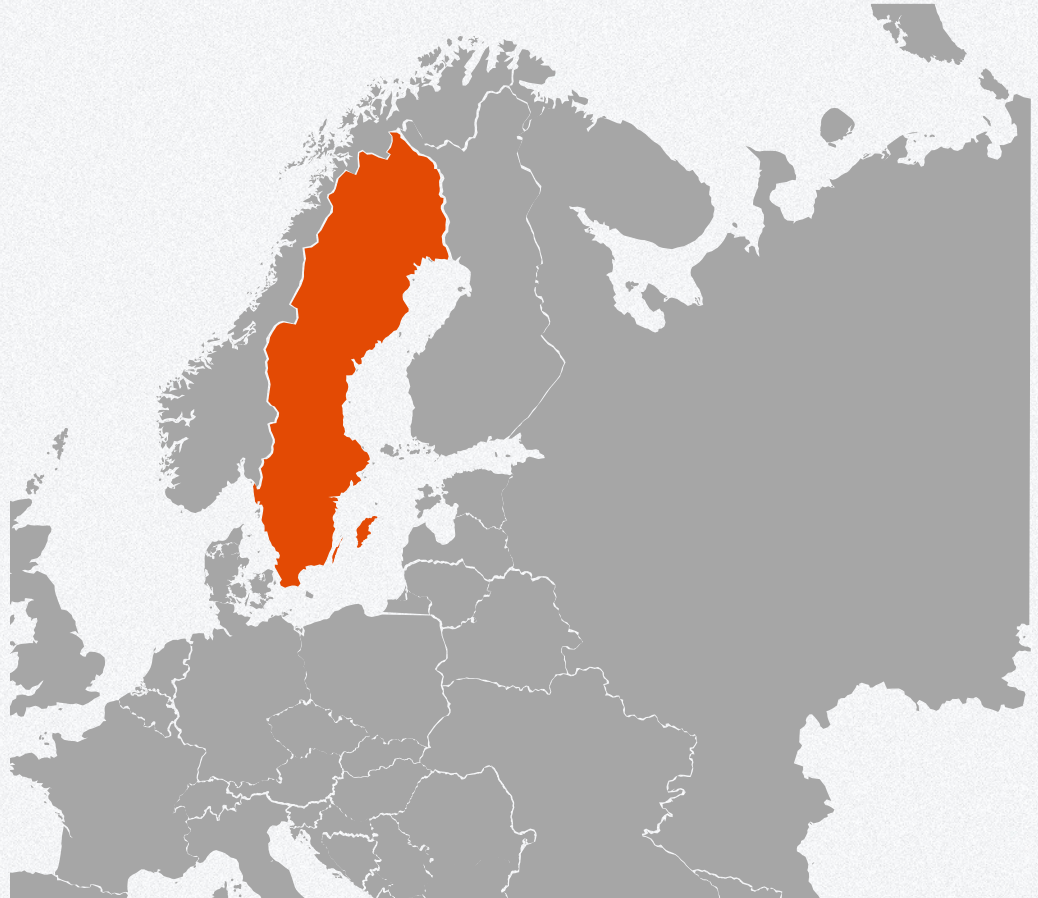

Atlas Copco Industrial Technique AB



Atlas Copco Industrial Technique AB, <https://atlascopco.com>
Photo: Atlas Copco Denmark, <https://atlascopco.com/da-dk>

Martin Karlsson, Head of Tightening Technique

Atlas Copco Industrial Technique AB is developing state-of-the-art assembly tools for global markets such as the automotive, aerospace, energy and electronics industries.

Atlas Copco's assembly tools already contain a large amount of software and connectivity to cloud services. The trends in the assembly industry are towards automated and more flexible production. Internet of things, artificial intelligence on the edge and a holistic system approach are key elements aiming at and beyond industry 4.0. The development of IoT and edge applications has to go hand in hand with trustworthiness and sustainability to be accepted both in industry and within society.

As the number of connected tools and services is expected to increase further, Atlas Copco is interested in exploiting edge computing systems for new services, and has therefore initiated research in this area, for instance with respect to system architecture and security.

"The development of IoT and edge applications has to go hand in hand with trustworthiness and sustainability to be accepted both in industry and within society."

Other major Nordic IIoT implementations

Smart meter opportunities

The Nordics have long been front runners in the roll-out of smart meters in Europe. Smart metering offers new opportunities for cost-effectively aligning supply and demand, and thus for increasing consumer energy awareness. New tariff structures are also being used to facilitate a higher share of renewable energy (e.g., during windy periods).

MAN Energy Solutions (DK)

The World's largest designer and producer of ship propulsion systems makes use of IIoT to monitor engine temperature, humidity, pressure and vibrations and provides these data on-line through a satellite enabled cloud.

Volvo Cars (SE)

Volvo On Call (VOC) is a service offered to Volvo car owners keeping them constantly in touch with their car. The service includes integrated emergency and roadside assistance. At the same time Volvo can collect diagnostic data from each vehicle. VOC also makes it possible to connect the car to the internet over mobile broadband.

Smart City Drammen (NO)

120.000 citizens in Drammen can take advantage of IIoT enabled services for smart trash bins, smart parking, smart street lighting and power access points for electrical cars. And the community benefits from on-line data on air and water quality as well as automated road pricing.

Posti (FI)

In less than a year the number of parcels travelling through Posti's self-service lockers increased by 56%. Self-service postal lockers bring things to everyone's reach and have made delivering and sending parcels easier and more efficient. Self-service lockers can also increase recycling and sustainability, and in the future the lockers can be used to recycle all kinds of goods, not just parcels. All lockers are IoT enabled to make them reliable, light, secure, and scalable.

Application areas

Smart anything, decarbonization
and healthcare

*Sustainable, smart
mobility and
transportation*

*Digitalization and
decarbonization of
industry*

*Resilient and smart energy
systems*

*Sustainable smart cities
and digital life*

Healthcare and wellbeing

Sustainable, smart mobility and transportation

Visions:

EU strategy for mobility and transport: measures needed by 2030 and beyond

Drive Sweden—Strategic Innovation Program

Wallenberg AI, Autonomous Systems and Software Program

Challenges for sustainable transportation, with an emphasis on highly automated urban goods transport and personal mobility

Automated driving as part of sustainable transportation represents a paradigm shift, with socio-technical challenges:

How should we resolve issues of responsibilities, insurances, legislation, standards and ethics?

Approval for operation: When is an automated vehicle ready for street operation?

How do we ensure trustworthiness and robustness of these highly automated systems?

How do we ensure that the corresponding solutions are cost-efficient and sustainable?



Digitalization and decarbonization of industry

Visions:

A new Industrial Strategy for a green and digital Europe (EU Commission)

Processes4Planet: Transforming the European Process Industry for a sustainable society (Horizon Europe, Sustainable Process Industry through Resource and Energy Efficiency)

ManuFUTURE Vision 2030, Strategic Research and Innovation Agenda 2030

Industry is important but contributes to emissions

Industry represents 12% of EU GDP, responsible for 35 million jobs, 80% of exports, 20% of total EU added value.

Energy Intensive Industries (EIIs): 15% of total direct CO₂e emissions in the EU -- reduced by 36% during 1990–2015, but more is needed.

“Europe needs an industry that becomes greener and more digital while remaining competitive on the global stage” (EU New Industrial Strategy)

Digitalization can help decarbonization

Digitalization is a key enabler for European Industry and is achieved by using IIoT (digitalization and networking of machines, products and people).

However, digitalization can both decrease or *increase* CO₂ emissions³; the role of policy is very important.

Challenges

Digitalization can improve the *energy efficiency* and innovation of industry, but there are many challenges related to: Smart manufacturing, Sustainable production, Circular economy, AI and digital industry, Digital twins, Augmented/virtual reality and telepresence, and Autonomous systems and robotics.

Energy efficiency is useful, but we also need a *menu of decarbonization options*: demand-side measures, electrification of heat, hydrogen and biomass as fuel, carbon capture and storage, innovative processes. New processes are needed to produce cement, steel, ammonia, and ethylene which contribute 45% of CO₂ emissions.

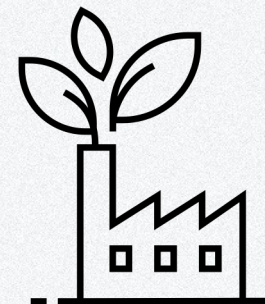

Resilient and smart energy systems

Visions:

*European Commission:
European Green Deal*

*International Energy
Agency (IEA): Digitalization
& Energy report*

Challenges

Ensuring sustainable power generation and energy conversion: lossless energy conversion and generation.

Achieving efficient community energy management: innovations such as decentralization, networking, peak use & oversupply times and storage systems lead to new challenges in energy management and distribution.

Reducing energy consumption: use IIoT-based smart systems to fulfil the 2030 EU vision of 30% savings.



Smart & resilient

“Traditional efficiency policy addresses devices individually. Digitalisation, with the right policies, enables a progression to optimising the efficiency of the whole energy system.” (IEA)

Digitalization is a key technology that drives the innovations in energy systems but leads to new security and privacy risks. New interconnected energy systems must be *resilient*. Other important challenges include:

Demand-side flexibility, such as smart demand response and smart charging of electric vehicles.

Integration of variable renewables, enabling grids to achieve a better match between energy demand and periods of high solar and wind energy generation.

Distributed energy sources: deployment of residential energy generation (solar) and storage, selling surplus to the grid.

The two biggest barriers (according to IEA) are privacy and cybersecurity.

Sustainable smart cities and digital life

Visions:

Horizon Europe Mission Area: Climate-neutral and smart cities

Viable Cities – Strategic Innovation Program with focus on Smart Sustainable Cities

Challenges are defined by one mission: 100 Climate-Neutral Cities by 2030 – by and for the Citizens

The main aim is to support, promote and showcase European cities in their systemic transformation towards climate neutrality, where "Smart systems and data platforms" is one among five key enablers. This will require:

World-class digital infrastructure and the deployment of the IoT and related applications at scale,

Open and interoperable datasets, linked and shared across the city ecosystem that can break down silos,

Generation of actionable insights through big data analytics and the use of Artificial Intelligence (AI).

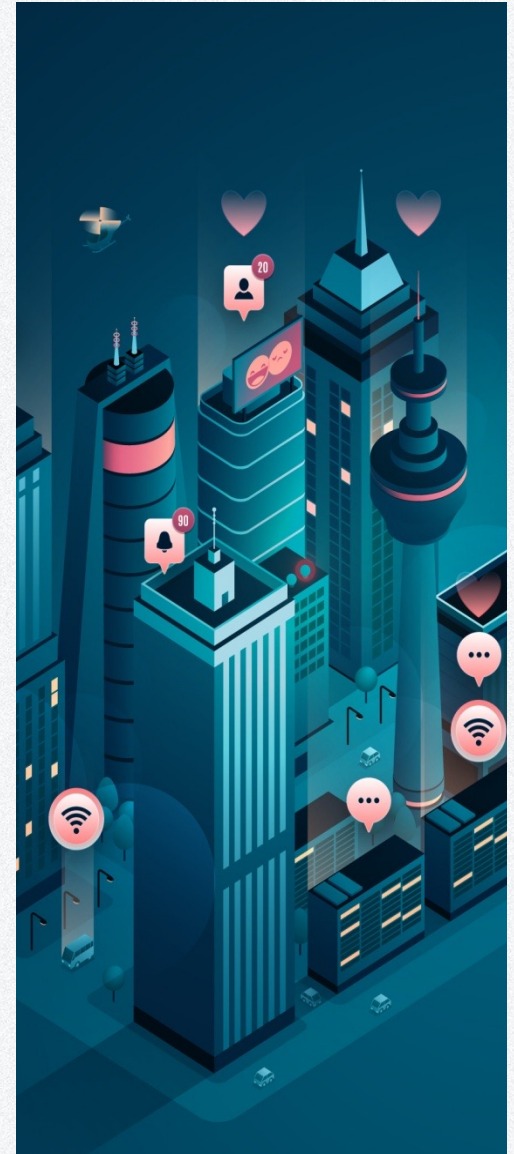

Healthcare and wellbeing

Visions:

*European Commission:
EU4Health 2021-2027 –
a vision for a healthier
European Union*

*UN Sustainable
Development Goals:
Goal 3: Ensure healthy
lives and promote well-
being for all at all ages*

Challenges

Healthcare is undergoing a digital transformation, accelerated by COVID19. The trends are towards predictive, preventive, personalized, participatory (4Ps) healthcare, and the use of telemedicine. Europe, including the Nordics, are at the forefront of medical technology, healthcare electronics, pharmaceutical industry and use of data. Major challenges are:

Creating digital health platforms, using data from IoT/wearables, employing AI, without compromising privacy & safety.

Enabling value-based and evidence-based healthcare, focused on prevention rather than treatment; use of point-of-care early diagnostics; decentralized clinical trials using wearable monitoring and delivery IoT devices.

Supporting healthy ageing, via innovations and digital transformations, including home care and patient monitoring.

Status and targets

Even before COVID19, ageing populations, labor and rising intervention prices were leading to increases in healthcare costs worldwide, projected to increase by 10% by 2030.

UN has several targets connected to the Sustainable Development Goal 3 related to healthcare and wellbeing: Reduce maternal mortality ratio, end preventable deaths of newborns and children, address epidemics such as AIDS, tuberculosis, water-borne diseases, halve the number of deaths from traffic, achieve universal health coverage, and reduce sickness caused by hazardous chemicals, pollution and contamination.

Although emissions in the EU have fallen by 25% since 2005, about 75% of people in European capitals have been exposed to particulate levels above WHO guidelines. 168 to 346 thousand deaths can be attributed to air pollution, which causes about 600 billion EUR in economic and welfare losses annually in the EU, 4.9% of EU GDP in 2017 (OECD).

Technological paradigms

Technologies facilitating the green transition

Artificial Intelligence & data analytics

Computing continuum & fog/edge computing

Smart electronic components & energy harvesting

Fourth industrial revolution

Digital twins

Enabling Communications Technologies

Artificial Intelligence & data analytics

AI refers to the simulation of human intelligence in machines that are programmed to react like humans and mimic their actions. The term may also be applied to any machine that exhibits traits associated with a human mind such as learning and problem-solving.

Data analytics is the process of inspecting, cleaning, transforming and modeling data with the goal of discovering useful information, informing conclusions and supporting decision-making.

AI and Data Analytics

Artificial Intelligence (AI) is a characteristic of an entity (or set of cooperating entities), which is able to receive inputs from the environment, interpret and learn from such inputs, and exhibit related and flexible behaviors and actions that help the entity to achieve a particular goal or objective over a period of time.

Data analytics is a process of inspecting, cleaning, transforming and modeling data with the goal of discovering useful information, informing conclusions and supporting decision-making. Data analytics has multiple facets and approaches, encompassing diverse techniques under a variety of names, and is used in different business, science, and social science domains. In today's business world, data analysis plays a role in making decisions more scientific and helping businesses operate more effectively.

Trends

The focus on machine learning (ML) and data-driven methods rather than general AI continues.

There is an increased focus on unsupervised learning to reduce the cost associated with data annotation.

Training large ML models based on large data sets requires large amounts of computational power and therefore energy. Hence, there is a trend towards energy-aware learning.

Trustworthy AI and ML are key to the long-term acceptance of AI. A vital aspect of this is development of explainable approaches to deep learning.

Integration and combination of data-driven and model-based and prior-knowledge based methods in, e.g., control and reinforcement learning (RL).

Networked learning in the form of distributed and federated learning.

Applications of RL to applications with continuous action and state domains.

Computing continuum & fog/edge computing

Fog computing: system-level architecture that distributes resources and services of computing, storage, control and networking anywhere along the continuum from Cloud to Things (OpenFog)

Computing continuum

Moore's law has driven down the costs of computing, communication and storage, enabling a microelectronics revolution. Digital computing systems are everywhere and they have many shapes.

Cloud computing has made huge on-demand computing resources available. However, the vast quantities of data generated by people and machines and the high dependability requirements of applications are pushing computational and data analytics activities towards the edge of the network.

Computing systems form a continuum (see figure below) between IoT sensors/actuators and devices, edge devices, Fog/edge, Cloud and High-Performance Computing (HPC). This view is shared by EU organizations collaborating in the TransContinuum Initiative.

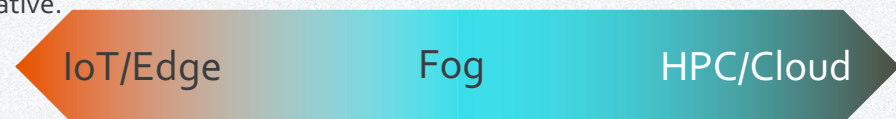

Challenges

Edge analytics: Sensors and machines generate huge amounts of data, and industrial data is growing faster than in any other sector. Large amounts of data cannot be moved to the Cloud due to bandwidth constraints; we need edge analytics and distributed learning.

Programming models and resource management: we need resource management and provisioning mechanisms for deploying scalable applications across the computing continuum. There are many trade-offs related to power consumption, performance and dependability.

Cybersecurity: The computing continuum brings new security challenges, exposing previously isolated devices, people and machines to new types of attacks.

Smart electronic components & energy harvesting

Smart Electronic Components: Integrated chips or Systems-on-Chip with AI capabilities, able to execute machine learning or inference algorithms.

Energy Harvesting: Scavenging energy from the surrounding environment as an alternative to batteries.

Smart and Sustainable

Energy Harvesting has been proposed as an alternative to batteries for powering the low-end sensing devices that generate the data in an IoT ecosystem. Various energy harvesters have been considered, including miniaturized solar panels, piezoelectric sensors for extracting energy from vibrations and other mechanical forces, and RF energy harvesters.

In parallel, the processors for sensing devices are becoming increasingly more intelligent with the capacity to do complex computations. Modern smart electronic components are equipped with AI accelerators for efficient on-device inference.

Trends

Tiny wearable/implantable computers that operate ubiquitously in all aspects of life.

Increased focus on green devices that operate perpetually with energy harvested from the environment (instead of batteries).

Electronic components with deep learning accelerators for on-board AI.

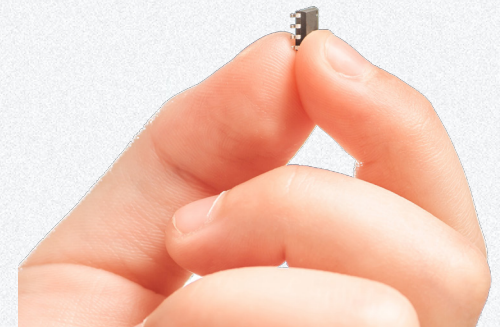

Fourth industrial revolution

Data: The central role of data calls for ways of dealing with data ownership, data privacy and data protection

Piloting: many small-scale pilots are conducted to learn from realistic-looking set-ups

Rich data and the ability to utilize the data is central for modern industry

In the past, much of the potential of added value for industry came from mass production and industrial automation. The modern approach is more about using the **data** and **deep intelligence** within large, often global, **platforms** and **networks**.

With respect to the technology, several layers are involved:

Enterprise resource planning

Product life-cycle management

Manufacturing operations management

Manufacturing execution systems

Development process for systems

Integration and inter-operability of systems

Challenges

The central role of data calls for ways of dealing with data ownership, data privacy and data protection. These concerns are especially prominent when third-party vendors are used for hosting and operationalizing company data.

The rise of the platform economy has already affected the ways business is done. The fourth industrial revolution calls for new business models and new definitions of industrial strategies and processes.

The importance of piloting

Jumping into this era of industry involves a learning process. One approach to this learning process is piloting. Conducting successful pilots, such as smart factories on a smaller scale, offers possibilities for learning.

Digital Twins

A digital twin is a digital model of an actual non-living or living physical entity; it has a 'live' connection with the physical system, so that it represents its actual status, and is used to derive a higher-level representation of the system's status and performance.

Characteristics and uses

A digital twin integrates IoT, AI, ML and analytics with spatial representations to create living digital simulation models that update and change as its physical "twin" changes.

Digital twins learn and update themselves in near real-time from multiple sources, e.g., sensors, the environment, machines, human experts, historical data. They can be combined with extended reality (XR) presence, i.e., mixed or augmented reality, or telepresence.

They are used in several industrial sectors (manufacturing, smart cities, automotive, healthcare) to optimize the systems' operations, maintenance, etc. Digital twins enable organizations to perform virtual commissioning and virtual engineering of heterogeneous multidisciplinary systems-of-systems; simulator-based design; simulation of energy & materials usage and waste, supporting sustainability.

DestinE

Digital twins can also be used to understand and reduce the environmental impact of systems, e.g., they can quantify the emissions of port operations and help in decision-making that reduces these emissions.

A notable initiative is DestinE: a digital twin of the Earth developed via European Union research—"a very high precision digital model to monitor and simulate natural and human activity, and to develop and test scenarios that would enable more sustainable development." (European Commission)

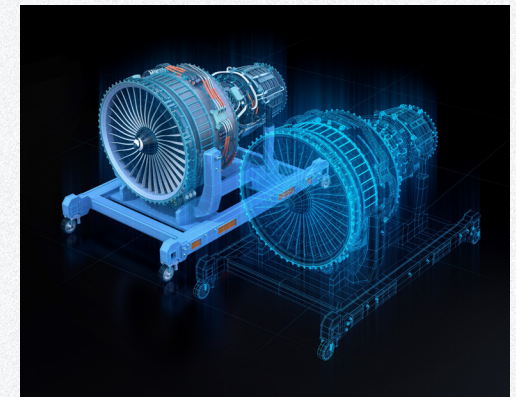

Enabling Communications Technologies

Communication technologies are essential enablers of the Internet of Things, where devices are connected to the Internet on a massive scale and/or have very demanding requirements for latency, bandwidth and power consumption.

Characteristics

A highly diverse set of requirements have led to the development of a multitude of technologies:

Bluetooth: An important short-range protocol due to the new Low energy version (BLE).

Zigbee: Similar to BLE, but applications are typically industrial.

WiFi: Widespread deployment makes it an appealing choice.

Cellular 5G/6G: 5G supports narrowband IoT and 6G will in time give ultra high bandwidth

LoRaWan: Supports Low power wide area applications and is popular for smart city and industrial applications.

Satellite: Ubiquitous broadband access at low cost, e.g., StarLink.

TSN: Time Sensitive Networking to support the most demanding applications.

Trends

An explosion in the number of devices to many tens of billions is expected after 2020.

Autonomous systems such as drones and self driving cars require low latency and highly reliable mission critical communication infrastructures.

IoT has a huge effect on the variety and volume of data processing, as billions of devices sense and push information at ever increasing rates.



Research priorities

Research areas where the Nordics can move the technological barriers

Automated driving for sustainable mobility & transport

Platforms and infrastructure for autonomous mobility

Consolidated IoT for Smart Environments

Self-powering systems for IoT & energy-efficient sensor networks

Safety, security and privacy by design

Remote attestation for IoT devices

5G and reduced power consumption of networks

Time-sensitive communication for vehicles and V2X

Dependable wireless communication

Low-power long-range communication

Resilient digital infrastructure for industry

Edge computing for smart grid

Reducing the energy consumption of HPC and datacenters

Wearables for healthcare and wellbeing

Platforms for point-of-care diagnostics

The Internet of Bio-Nano Things

Education and lifelong learning

Automated driving for sustainable mobility & transport

Topics

Defining risk for automated driving and developing strategies for risk management

Understanding and predicting intent of other road users

Methodologies for verification and validation of highly automated driving

Cost-efficient safety architectures able to deal with high reliability and availability requirements

Opportunities for data sharing and coordination with traffic infrastructure to reduce climate impact

These topics are also touched upon by several roadmaps including, for example, the ECSEL MASP and the recommendations from Platforms4CPS

Stakeholders

Automotive OEMs.

Service providers.

Tier 1 and 2 component providers.

Road and communication infrastructure providers.

Safety assurance agencies.

Transportation authorities.

Universities (research and education).

Autonomous vehicle: a vehicle that is capable of sensing its environment and moving safely with little or no human input (Wikipedia)

Sustainable development is development that meets the needs of current generations without compromising the ability of future generations to meet theirs (European Commission)

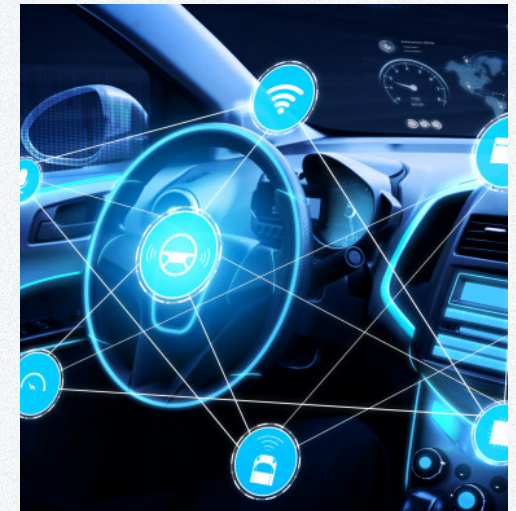

Platforms and infrastructure for autonomous mobility

Intelligent transport system (ITS): innovative services [and] different modes of transport and traffic management [enabling] users to be better informed and make safer, more coordinated, and “smarter” use of transport networks (Wikipedia)

Platform: A collection of interoperable system engineering bricks that can be used to set up a system engineering environment in a company.

Intelligent Transport Systems

Mobility systems and Intelligent Transport Systems (ITS) include, for example, traffic systems and logistic systems but also various systems for integration and interoperability. In many systems, humans are in the loop.

Topics

In-vehicle computing platforms that include both hardware (multiple systems-on-chip with multicores, GPUs and machine learning accelerators) and software solutions (with hypervisors, middleware, real-time operating systems). The platforms should handle large amounts of computation and data processing, including support for deep learning.

Physical augmentation of the environment, typically communication networks and embedded sensor systems to determine the status and pass it to mobility management systems.

Challenges

Increased performance of computing and communication components.
Dependability of platforms and infrastructure; safety assurance; cybersecurity and privacy.

Stakeholders

Large companies, platform and infrastructure providers, research organizations, public transport companies, local councils and governmental organizations.

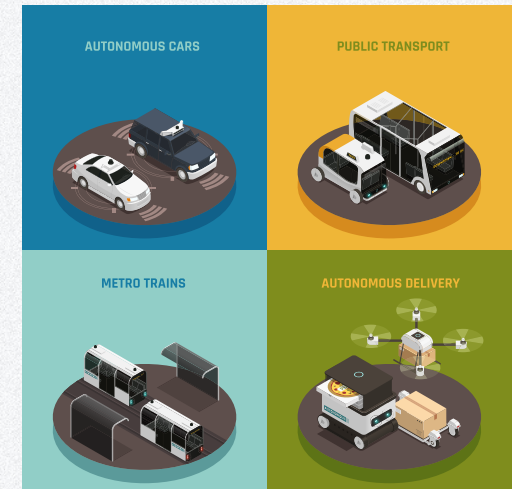

Consolidated IoT for Smart Environments:

merge silo solutions into shared services and platforms

Context

IoT systems in smart cities and buildings are often developed in isolation as silos by different vendors, resulting in duplicating software and hardware which overall cost more, take more time to develop, deploy, and maintain.

Stakeholders

Local governments
Standardization bodies
Service providers
IoT device & platform developers
Universities & Research Institutes
European Commission

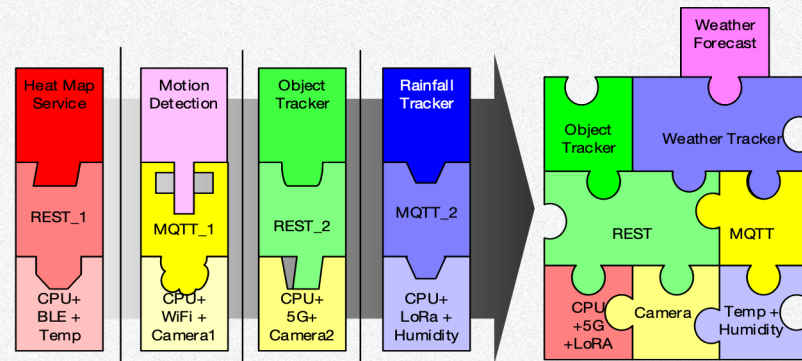

Topics

Virtualization is a key to decoupling infrastructure from functionality. This is relevant both at device level via virtual machines or containers and at network level via software-defined networks.

Such systems need efficient runtime environments and distributed OSes able to monitor and migrate functionality.

These solutions require new analysis methods and tools for gauging their quality-of-service, energy consumption, security, reliability, etc.

Other open research topics include domain specific programming languages, standards for platforms and services, secure data and computation.

Virtualization: process of running a virtual instance of a computer system in a layer abstracted from hardware (opensource.com)

Consolidate: to join together into one whole; to make firm or secure; to form into a compact mass (Merriam-Webster)

Self-powering systems for IoT & energy-efficient sensor networks

Self-powering systems: Sensing platforms that are powered by energy harvested from the environment, such as solar and light energy, vibrations and other mechanical forces, and wireless signals.

Energy-efficient sensor networks: Connected sensing devices that need to efficiently use severely limited energy resources (tiny batteries or energy harvesting)

Topics

Energy-efficient medium access control, routing and application-layer protocols for large sensor networks

Lightweight security and privacy, efficient key management and distribution, and end-to-end encryption

Energy-efficient and resource-constrained on-device AI

Reliable wireless communication powered by unreliable, yet sustainable, energy sources

Intermittent computing to enable the execution of complex programs in multiple bursts of operations

Stakeholders

Standardization working groups (IEEE, IETF).

Microelectronics Industries.

Municipalities (Smart Cities).

Smart Hospitals, Factories, Farms.

Universities (research and education).



Safety, security and privacy by design

Safety/security/privacy-by-design: all methods, techniques and tools aiming at reinforcing safety, security and privacy properties at both network and system level from conception and through the entire system life cycle.

Topics

Design of new energy-efficient safety/security solutions to incorporate end-to-end security & privacy protection in IoT devices.

Extension of existing security-by-design and privacy-by-design methods towards distributed, adaptive, learning IoT systems.

Delivery of high-assurance proofs that embedded protection controls are included throughout the entire system and data lifecycle.

Combined safety and security certification.

Exploration and extension of existing standards and recommendations (in line with e.g., EMA, CE, PDMA, FDA, NHTSA, ETSC), and open and standards-based architectures (such as IEEE1934 and FORA)

Some of these topics are also included in the ESC-SRA 2020 roadmap.

Challenges

Designing architecture for continuous safe and secure updates for distributed safety-critical CPS solutions including operation safeguards and graceful degradation, run-time performance and resource monitoring / management.

Stakeholders

Service providers.
IoT device & platform developers.
Universities & Research Institutes.
Industry partners.



Remote attestation for IoT devices

Topics

Enabling partial attestation for low-battery devices.

Energy-efficient collective attestation approaches which rely on lightweight crypto operations.

Comprehensive design and effective implementations of attestation approaches for highly dynamic IoT networks.

Enhanced attestation techniques for detection of zero-day exploits which corrupt program's control flows.

Design of a publicly verifiable attestation scheme.

Stakeholders

Trusted Computing authorities.
Standardization bodies.
IoT device & platform developers.
Universities & Research Institutes.
Industry partners.
General end-users.

Remote attestation: a two-party security protocol that allows a remote device to validate the integrity of hardware and software configurations of potentially untrusted IoT devices.

Collective attestation: a remote attestation approach that aims at attesting a large-scale IoT network in more efficient way than attesting each IoT device individually in a sequential order.

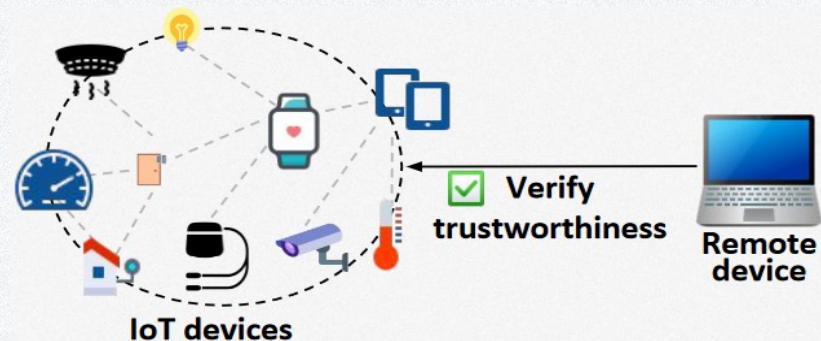

5G and reduced power consumption of networks

5G: the fifth generation of mobile communication networks, addressing for the first time use cases beyond mobile voice and broadband for the consumer market.

Topics

Enhanced mobile broadband (eMBB) for high capacity data communication.

Massive machine-type communication (mMTC) for IoT applications with extended coverage and low power consumption.

Ultra-reliable low-latency communication (URLLC) for industrial, automotive and maritime applications.

Edge computing and network slicing in public and private 5G infrastructure.

Performance analysis of 5G technologies and solutions with respect to data rates, range, latency and power consumption.

Adaptation of 5G technologies for bespoke systems in industrial automation.

Stakeholders

Process and manufacturing industry.
Offshore wind energy industry.
Automotive industry.
Smart grid organizations.
Maritime industry.
Healthcare industry.



Time-sensitive communication for vehicles and V2X

Time Sensitive Networking (TSN): Methods and tools to support low latency and deterministic communication in packet-based networks such as Ethernet.

V2X (Vehicle-to-Everything): Enables vehicles to communicate with other vehicles or the environment around them.

Topics

Communication platforms with time sensitive networking to support mixed criticality applications.

Replacement of current multiple vehicle bus systems by Ethernet and Time Sensitive Networking.

In-vehicle network orchestration algorithms supporting mixed criticality.

Fully automated TSN orchestration tools supporting all domains: chassis, engine, cabin and driver assistance.

Time- sensitive V2X communication for real time applications, i.e., traffic updates, hazard information and assisted driving applications.

Relevant standardization bodies are IEEE (Time sensitive Networking profile for Automotive) and 3GPP (4G and 5G).

Stakeholders

Automotive OEMs.
Service providers and telecommunication companies.
Tier 1 and 2 component providers.
Safety assurance agencies.
Transportation authorities and certification bodies.
Universities.

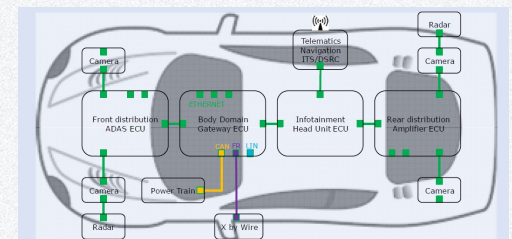

Dependable wireless communication

Topics

Ultra-reliable wireless networking protocol stacks (TSCH/6TiSCH, Concurrent Transmissions, IETF RAW).

Dependability and reliability enhancements for common yet unreliable wireless technologies (e.g. Bluetooth Low Energy, LoRa).

Reliable mobility and dependability in very dynamic environments, such as urban environments with extreme interference.

Scheduling transmissions efficiently in both the time and frequency domain, and robust temperature-resilient time synchronization.

Convergence of multiple wireless/wired communication technology (TSCH/6TiSCH, TSN, 5G URLLC).

Stakeholders

Standardization working groups (IETF 6TiSCH, IETF RAW).

Computer Networking Industries.

Microelectronics Industries.

Municipalities (Smart Cities).

Smart Hospitals, Factories, Farms.

Universities (research and education).

Dependable Wireless: Ultra-reliable wireless technology that ensures that all transmitted packets are received successfully by the intended receiver despite challenges in the wireless environment, such as interference and obstacles.

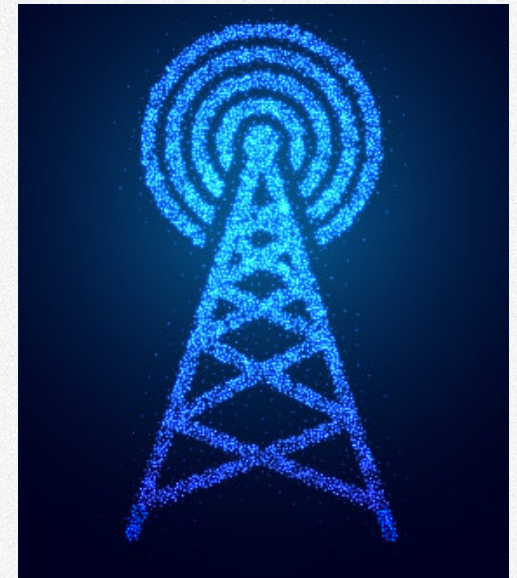

Low-power long-range communication

Low power: Communication technology constrained by the industrial vision of several years' runtime on battery, or even no battery with energy-harvesting operation.

Long Range: Focus on high radio coverage, even in extreme zones, such as in deep indoor scenarios. Example technologies are LoraWAN, Sigfox and NB IoT.

Topics

Security for low-power long-range communication networks (LPWANs), which are often directly connected to the Internet.

Lightweight Security, due to energy constraints in IoT networks.

Sustainable Security for Internet of Things (SSIoT), a new research angle to be defined.

Deep indoor coverage, where more sophisticated models for path loss are needed.

Emerging LPWAN technologies: NBIoT and LTE-M.

Stakeholders

Standardization working groups (3GPP, etc.).

Lora Alliance.

Sigfox Foundation.

Network operators.

Smart cities and smart grid.

Smart Factories.

Universities (research and education).



Resilient digital infrastructure for industry

Cyber resilience: an ability to continuously deliver the intended outcome, despite adverse cyber events (Wikipedia)

Low-carbon economy (decarbonized economy): an economy based on low-carbon power sources [with] a minimal output of greenhouse gas (GHG) emissions (Wikipedia)

Topics

Managing the increasing interconnectivity, complexity and life-span of systems; improving the interoperability of industrial and energy systems.

Realizing autonomous functions of systems. Improving the resilience of industrial and energy systems.

Improving the European sovereignty and sustainability of AI, cloud and edge computing.

Realizing innovative and resilient wired and wireless connectivity, beyond 5G.

Digital twins for monitoring, simulation and prediction of industrial, energy and cyber-physical systems.

Reducing the energy consumption of computing and communication systems.

See also: ECS Strategic Research and Innovation Agenda 2021

Digitalization, resilience and decarbonization

Digitalization via digital components and systems has unlocked innovations in the industrial sectors and underpins the efficiency of industry and energy systems.

With the right policies, digitalization can enable the vision of a low-carbon economy. However, the main barrier is the resilience of the infrastructure, which is exposed to cybersecurity risks.



Edge computing for smart grid

Edge computing is a new architectural paradigm in which the resources of (edge) servers are not centralized but distributed around the Internet, in close proximity to the cyber-physical systems, mobile devices, sensors and IoT endpoints which they serve.

Trends

The trend is to go from energy silos to digitally interconnected systems:

From low connectivity to high connectivity, enabling big data and analytics; from low electrification to electrification of buildings and vehicles; from a centralized system to decentralized energy supply.

Topics

Edge & AI-based Smart home management systems. E.g.: demand-side management.

Smart Grid Market applications at the edge. E.g.: using autonomous agents.

Deterministic Ethernet for low-latency control and emergency messaging.

Edge computing architectures for the smart grid, using deterministic virtualization and communication technologies.

Smart grid

A *Smart Grid* is an electricity network that can cost efficiently integrate the behavior and actions of all users [...] to ensure economically efficient, sustainable power system with low losses and high levels of quality and security of supply and safety (EC Task Force for Smart Grids).

By 2040, 1 billion households and 11 billion smart appliances could be part of a smart grid (IEA). Smart grid integrates renewables and uses smart demand/response to generate savings and reduce emissions: 30 Mt CO₂ emissions in 2040 in the EU alone.



Reducing the energy consumption of HPC and datacenters

High Performance Computing (HPC) refers to the practice of aggregating computing power in a way that delivers much higher performance than one could get out of a typical desktop computer or workstation in order to solve large problems in science, engineering, or business (USGS).

Challenges and topics

All digital systems consume energy. The challenge with HPC and datacenters is to reach exascale sizes, and beyond, with reasonable energy costs.

New semiconductor technologies do not improve power consumption; the power density is increasing.

Instead, research and innovation is needed to limit growth in energy demand of HPC and datacenters: novel architectures and implementation technologies, efficient AI platforms, accelerators, tools and algorithms.



Energy use statistics

Total electricity demand of ICT is accelerating, projected to increase in the worst-case to 21%; best-case scenario is 8% (Anders Andrae, Huawei Technologies).

Data centers account for about 1% of global electricity demand (IEA Data Centres and Data Transmission Networks report). They use about 200 terawatt hours (TWh) each year, more than the energy consumption of some individual countries. During the COVID19 pandemic, global internet traffic increased by 40%.

AI models use increasingly large amounts of energy; the computational resources needed double every 3.4 months (Forbes). Training a single deep learning model can generate CO₂ emissions equivalent to up to five cars (Strubell et al., Energy and Policy Considerations for Deep Learning in NLP, arXiv:1906.02243).

Wearables for healthcare and wellbeing

IoT wearable technology gives new opportunities for healthcare and wellbeing i.e. by instant warnings to health care professionals

Wearables refer to headbands, watches and wrist born devices, socks, shoes, motion trackers, cameras, sensors embedded in clothing etc.

Applications

Wearables are electronic devices that are physically worn by individuals in order to track, analyze and transmit personal data. There has been an increasing interest in the development of wearable devices for both fitness and healthcare applications. These “smart” IoT devices can track biometric data from heart rate and ECG (electro-cardiogram) to sleep patterns and are also becoming popular technologies in the gaming and fashion industries.

Wearables are widely used in healthcare, where they allow patients to monitor vital health conditions in real-time and doctors to track changes or anomalies for a faster diagnosis.



Enabling technologies

Wearables are resource-constrained embedded IoT devices relying on research on enabling technologies, such as flexible electronics for sensors and PCB design, energy harvesting from motion, temperature gradients or light, 3D printed stretchable sensor on fabric and sensor for monitoring the swelling and temperature of people.

Innovative microfabrication and liquid manipulation techniques have allowed the incorporation of micro-fluidics in wearables. The development of these technologies has made possible several biosensing applications, including in situ sweat metabolite analysis, vital sign monitoring, and skin patches.



Platforms for point-of-care diagnostics

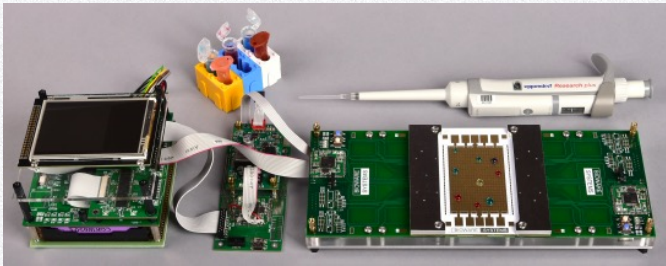

Point-of-care diagnostics (or Point-of-care testing) is defined as medical diagnostic testing at or near the point of care—that is, at the time and place of patient care (Wikipedia).

A *lab-on-a-chip* is a device that integrates one or several laboratory functions on a single integrated circuit (commonly called a "chip") of only millimeters to a few square centimeters to achieve automation and high-throughput screening. (Wikipedia)

Enabling technologies

Point-of-care (POC) diagnostic devices are increasingly used for diagnostic and detection of diseases, as they have many advantages, such as, portability, speed and precision, low cost, without requiring more specialized equipment. They have been used in many areas, including measuring blood glucose, and detection of fertility, pregnancy and infectious diseases, incl. Sars-Cov-2.

The development of POC devices is driven by interdisciplinary research integrating smart biosensors with miniaturized liquid handling technologies, controlled by microelectronic platforms, which also digitize, process and transmit the results, making POC devices possible 'things' on the internet.

Microfluidic lab-on-a-chip devices are one of the key enabling technologies of POC diagnostics, and use various fluid handling techniques, such as capillary, pressure driven, centrifugal, electrokinetic and acoustic techniques.

Market and companies

The global market for point of care (POC) diagnostics and testing should grow from \$19.3 billion in 2018 to \$25.5 billion by 2023 with a compound annual growth rate (CAGR) of 5.7% from 2018 to 2023 (Ref).

Major global company players within the POC market, include Abbott Laboratories, Beckman Coulter, Inc., Becton, Dickinson and Co., Danaher Corp., Roche and Siemens Medical Solutions.



The Internet of Bio-Nano Things

Emerging technologies

The Internet of Bio-Nano things (IoBNT) is an emerging sub-field of the Internet of things where “nano-scale biological organisms, bacteria, and synthetic organisms” correspond to IoT objects. Thus, they can be adapted to work with the real-world communication mediums, such as the Internet.

Since these living cells already respond to their environment stimuli through electromagnetic fields, light, temperature stresses, and mechanical pressure, they make effective replacements for chip-based sensors due to their added sensitivity.

Harnessing the special features of bacteria, including an ability to become autonomous - helped by an embedded, natural propeller motor - the microbes show promising array of application in healthcare and environmental health.

Applications

Due to their size and simple structure, nanomachines individually have limited functionality. However, when they start to communicate to each other and construct nanonetworks, they are expected to collaboratively achieve more complex tasks and promise new solutions for several applications in biomedical, industry and military fields.

Traditional computing and communications paradigms are not applicable due to the challenges posed by the physical laws governing this regime, and novel methods are required to realize nano networks.

Recent developments in nanotechnology have enabled the manufacturing of low-power and low-cost nanoscale machines, i.e., nanomachines, with basic sensing, actuating and computing capabilities.

IEEE P1906.1.1 – Standard Data Model for Nanoscale Communication Systems. ACM NanoCom conference.

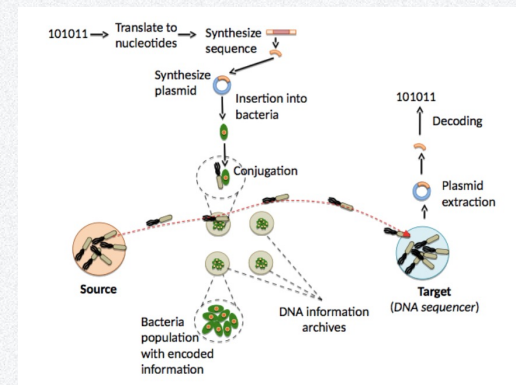

Education and life-long learning

The Nordic Hub on Industrial IoT acts as a collaboration network and graduate school with currently 45 PhD students grouped in four thematic areas: Networking, Fog/edge computing, Cloud computing and Data analytics & machine learning.

Apart from having the benefit of jointly organized Hub courses, events and contacts, the students may also take advantage of access to expensive equipment and labs across the five institutions involved. The Hub students have access to nearly 30 joint labs & equipment, including the IoT prototyping lab, ABB robot lab, Drones, ITS testbed, Industry 4.0 lab, and 5G lab. However, their mobility has suffered due to the Covid-19 pandemic. Knowledge generated in their thesis work naturally flows into the educational system via the PhD students and their supervisors, incorporating research work and examples into (primarily) advanced courses.

Furthermore, the Nordic Hub considers life-long learning, beyond traditional engineering and graduate education, to be important. Competence networks are being tested as a solution by providing a new, industry-close learning environment based on up-to-date educational practice.

So far, the partners have provided ten such training courses. Sometimes these courses are arranged as 2+2 intensive days with at least a couple of weeks in between for reflection and project work. The number of participants has been around 20 people.

On-line and “flipped classroom” learning concepts will be promoted by the Hub partners, aiming for modular courses of relevance in a multidisciplinary setting for engineering and PhD students as well as for practicing engineering. The effort will draw upon the complementary skills of the Hub partners.



Acknowl- edgements

Contributors



List of contributors

Michael Stübert Berger, DTU
Nicola Dragoni, DTU
Edlira Dushku, DTU
Xenofon Fafoutis, DTU
Flavius Gruian, LU
Jussi Hanhiova, Aalto
Vesa Hirvisalo, Aalto
Sven Karlsson, DTU
Erik Larsson, LU
Jan Madsen, DTU
Ivan Ring Nielsen, DTU
Martin Nordal Petersen, DTU
Stig Petersen, NTNU
Sarah Renée Ruepp, DTU
Niklas Reusch, DTU
Martin Schoeberl, DTU
Amund Skavhaug, NTNU
Kari Tammi, Aalto
Tobias Vahlne, KTH
Ying Yan, DTU
Karl-Erik Årzén, LU

Affiliation:

Aalto: Aalto University (FI)
DTU: Technical University of
Denmark (DK)
KTH: Royal Institute of Technology
(SE)
LU: Lund University (SE)
NTNU: Norwegian University of
Science and Technology (NO)

Acknowledgements

The editors want to acknowledge NordForsk for providing the funding through the grant agreement no. 86220 and Prof. Haydn Thompson for an inspiring keynote talk during our Hub Workshop on 28th of November 2019 in Stockholm and for his support throughout the entire roadmap process.

Acronyms

<i>AI</i>	<i>Artificial Intelligence</i>
<i>BLE</i>	<i>Bluetooth Low-Energy</i>
<i>CAGR</i>	<i>Compound Annual Growth Rate</i>
<i>CPS</i>	<i>Cyber-Physical System</i>
<i>GPU</i>	<i>Graphics Processing Unit</i>
<i>HPC</i>	<i>High-Performance Computing</i>
<i>ICT</i>	<i>Information and Communications Technology</i>
<i>IIoT</i>	<i>Industrial Internet of Things</i>
<i>IoT</i>	<i>Internet of Things</i>
<i>ITS</i>	<i>Intelligent Transportation Systems</i>
<i>LPWAN</i>	<i>Low-Power Wide-Area Network</i>
<i>ML</i>	<i>Machine Learning</i>
<i>OEM</i>	<i>Original Equipment Manufacturer</i>
<i>TSN</i>	<i>Time-Sensitive Networking</i>
<i>V2X</i>	<i>Vehicle-to-everything</i>

Credits

Page 6: petovarga, Adobe Stock (Licensed)
Page 7: European Commission
Page 8: Nordic Energy Research
Page 9/25/27/29/31 (Maps): punkl.
Page 10: European Commission
Page 11: j-mel, Adobe Stock (Licensed)
Page 12-14: Logo of the respective initiative
Page 15-21, 23: Front page of respective roadmap
Page 22: chokniti, Designed by Freepik (Licensed)
Page 26: Danfoss – Our Businesses – Drives, <http://bit.ly/3eoQMRN>
Page 28: Janne Harjuhahto, Maillefer Blog, <http://bit.ly/3uRw24U>
Page 30: Bane NOR Pagertpage English, <http://bit.ly/3c4obFo>
Page 32: Atlas Copco Denmark, <https://atlascopco.com/da-dk>
Page 35: biancoblue, Designed by Freepik (Licensed)
Page 36: "eco friendly factory", laymik, thenounproject.com
Page 37: evening_tao, Designed by Freepik (Licensed)
Page 38: pikisuperstar, Designed by Freepik (Licensed)
Page 43: alexeygalutva, Designed by Freepik (Licensed)
Page 45: chesky, Adobe Stock (Licensed)
Page 46: sebdeck, Designed by Freepik (Licensed)
Page 48: biancoblue, Designed by Freepik (Licensed)
Page 49, macrovector, Designed by Freepik (Licensed)
Page 51: seventyfour, Designed by Freepik (Licensed)
Page 52: rawpixel.com, Designed by Freepik (Licensed)
Page 54: stockphoto mania, Adobe Stock (Licensed)
Page 56: starline, Designed by Freepik (Licensed)
Page 58: kjpargeter, Designed by Freepik (Licensed)
Page 59: redgreystock, Designed by Freepik (Licensed)
Page 60: Sashkin, Adobe Stock (Licensed)
Page 63: Licensed via IEEE/RightsLink

© Nordic University Hub on
Industrial IoT, nordic-iot.org

