

The Poor Man's Guide to Computer Networks and their Applications

Robin Sharp

Informatics and Mathematical Modelling, DTU

September 2003

Contents

1	Introduction	2
2	Networks	3
3	Layered Architectures	4
3.1	The OSI Reference Model	4
3.2	Other layered architectures	8
4	Services and Protocols	10
4.1	Services	10
4.2	Quality of Service	15
4.3	Protocols	16
5	Network Technology	20
5.1	Routers	21
5.2	Bridges	22
5.3	LAN Technologies	23
6	Basic Protocols in the Internet	28
6.1	Internet Protocol, IP	28
6.2	Transmission Control Protocol, TCP	34
6.3	User Datagram Protocol, UDP	37
6.4	Internet Application Layer Protocols	37
7	Simple Mail Transfer Protocol, SMTP	38
7.1	The Basic SMTP protocol	39
7.2	MIME	42

8	HTTP and the World Wide Web	47
8.1	Uniform Resource Identifiers	47
8.2	Hypertext Transfer Protocols	50
9	Network Programming with Sockets	54
9.1	Java Client Sockets	55
9.2	Java Server Sockets	58
10	Remote Procedures and Objects	61
10.1	Remote Procedure Call	62
10.2	Binding	64
10.3	Remote Object Invocation	65
11	CORBA	73
11.1	The Object Request Broker	73
11.2	CORBA Interfaces and CORBA IDL	75
11.3	CORBA Clients and Servers	77
12	Web Services and SOAP	82
12.1	XML Encoding of the Request Message	85
12.2	SOAP Response Messages	85
12.3	SOAP Types	86
12.4	Web Service Clients and Servers	89
13	Further Reading	94

1 Introduction

These days, computers very rarely operate on their own. Instead, they are connected together by computer networks which enable them to exchange information. There can be many reasons for wanting to do this in relation to a particular computer application. For example:

- The application may directly involve *transfer of information* between human users, as in systems for transferring e-mail or other documents, or in teleconferencing.
- The application may involve a need to *access an information base* of some kind, as in searching the World Wide Web, electronic banking or database applications.
- The application may need several computers to *collaborate* on performing a large calculation, or to *share* data or other resources, as in many technical computations in engineering, the natural sciences and economic modelling.

The aim of these notes is to present the main concepts of computer networks, give a very short introduction to their architecture and technology and give some simple examples

of how the use of networks can be incorporated into applications. There are many books which deal with the subject in much more detail. You should consult some of the references in the bibliography if you want to know more about a particular topic.

2 Networks

Basically speaking, a computer network consists of a set of *nodes* connected by *communication links*. In simple cases, the nodes are *end systems*, i.e. computers which run applications, using the links to communicate with one another. In larger or more complex systems, however, some of the nodes just deal with aspects of the communication process, such as choosing a suitable route for data which is being sent between two end systems, and do not directly take part in applications. Such nodes are often known as *communication nodes*. An example of such a network is illustrated in Figure 2.1. The communication nodes are indicated by full circles and the end systems by unfilled circles.

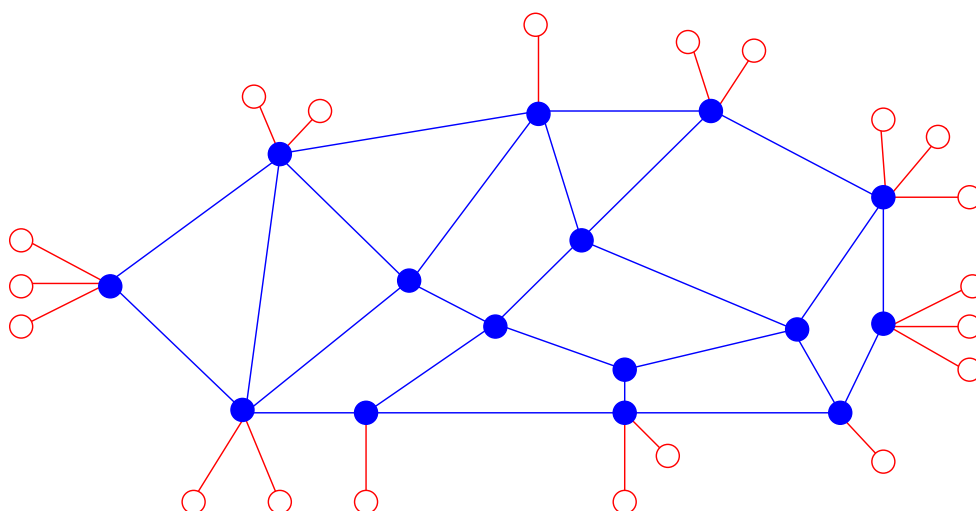

Figure 2.1: A network with communication nodes (●) and end systems (○)

Computer networks are often classified according to their physical size, as this to some extent determines the communication technology on which they can be based. It is traditional to distinguish between:

Local Area Networks (LAN): Small networks, with a size of up to a few kilometers, typically covering a building or a single company or institution.

Wide Area Networks (WAN): Large networks, covering a large geographical area, such as a whole country, or perhaps even the whole world.

Metropolitan Area Networks (MAN): Networks covering a town or other relatively large area.

Some of these distinctions are historically based, since for legal reasons it was at one time important whether the network was run by and for a single owner such as a company or university (who were only allowed to set up a LAN covering a limited area), or whether the network's capacity was intended to be sold to subscribers in general (typically a WAN, which could only be run by an privileged telecommunications monopoly). Nowadays, where telecommunication services have in most countries been extensively liberalised, this type of criterion is less important. However, the basic differences in technology remain. We discuss some of these below in Section 5.

3 Layered Architectures

The requirement that some nodes in a computer network should be able to do more than others leads naturally to the idea that systems in a network can be built up as a number of *layers*, where the upper layers add some kind of extra functionality to the lower ones. Thus for example, an end system can be built up as a communication node with one or more extra layers to add the functions needed for dealing with the requirements of the applications.

In a layered architecture, each layer – by building on the facilities offered by the layer beneath – becomes able to offer the layer above a *service* which is different from the service which it itself is offered. As a rule it will be better (more reliable, more free of errors, better protected against “intruders”, ...) or will offer more possibilities than the layer beneath. This is achieved by the active components in the N 'th layer – often denoted the (N) -*entities* – exchanging information with one another according to a set of rules which are characteristic for the layer concerned – the (N) -*protocol*. A simple example could be that they exchange information with a certain degree of redundancy, so that any errors which are introduced by the layer beneath – the $(N-1)$ -*layer* – can be detected and corrected. The (N) -*service* which they offer to the active components in the $(N+1)$ -*layer* – the $(N+1)$ -*entities* – can thus be less disturbed by errors than the $(N-1)$ -*service* which they are offered by the $(N-1)$ -*layer*. This is illustrated in Figure 3.1.

3.1 The OSI Reference Model

An important and well-known example of a layered architecture for communication systems is described in the OSI Basic Reference Model [9] developed and standardised by the International Organization for Standardization (ISO) in the 1980s. The acronym OSI stands for *Open Systems Interconnection*, and is a general term covering everything which has to be considered when systems (especially computer systems) have to cooperate with one another, or – to use a more technical term – to *interwork* across a communication

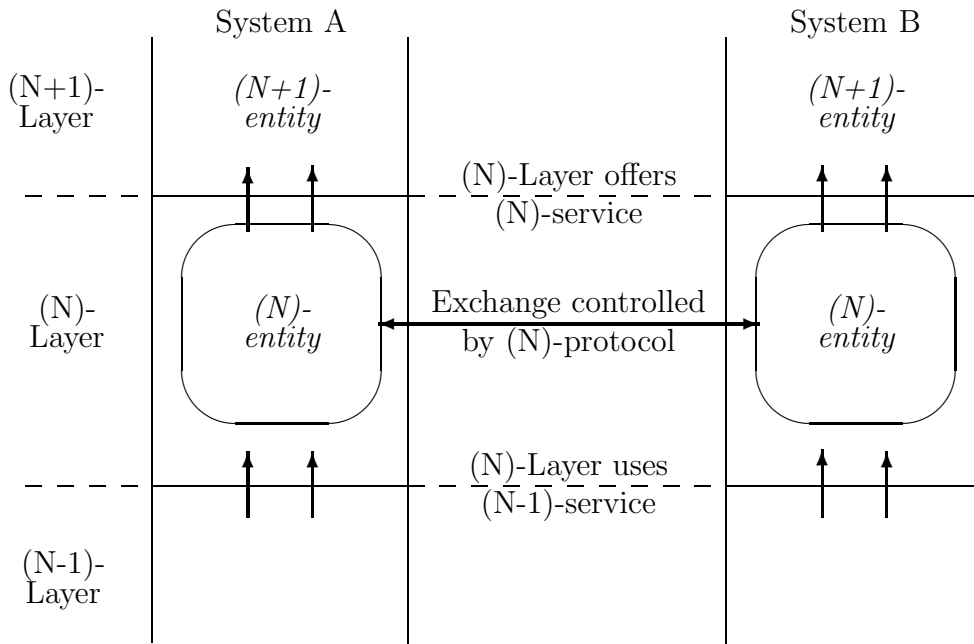

Figure 3.1: Principles in a layered architecture

network in a manner which is independent of manufacturers' system-specific methods. The OSI Reference Model defines the most basic principles for this purpose.

To do this, the OSI Reference Model describes a layered architecture, defines which layers are conceptually to be found in a standard communication system, which services these layers offer and which functions the individual layers are expected to be able to perform in order to offer these services. The model specifically describes seven layers, whose main functions are shown in Figure 3.2.

The lower three OSI layers are intended to supply communication services for transferring data between systems in the network. The Physical layer offers facilities for transmitting individual bits (or groups of a few bits), typically in the form of electrical or optical signals, on the physical medium¹ between two systems. Since most media and the associated transmitting and receiving electronics are susceptible to being disturbed by electrical noise, this does not in itself provide a reliable method of data transfer. The Data Link layer therefore introduces facilities for sending blocks of data and for checking them for errors by the use of error-detecting or -correcting codes. This provides more reliable communication, but can only transmit data between systems which are *directly connected*, in the sense of being connected by a fibre or cable or having access to a shared medium, such as a broadcast channel or a shared bus. To be able to send data to arbitrary nodes which are not directly connected, extra facilities are needed in order to choose a suitable route

¹which you should incidentally note is *not* part of any of the layers.

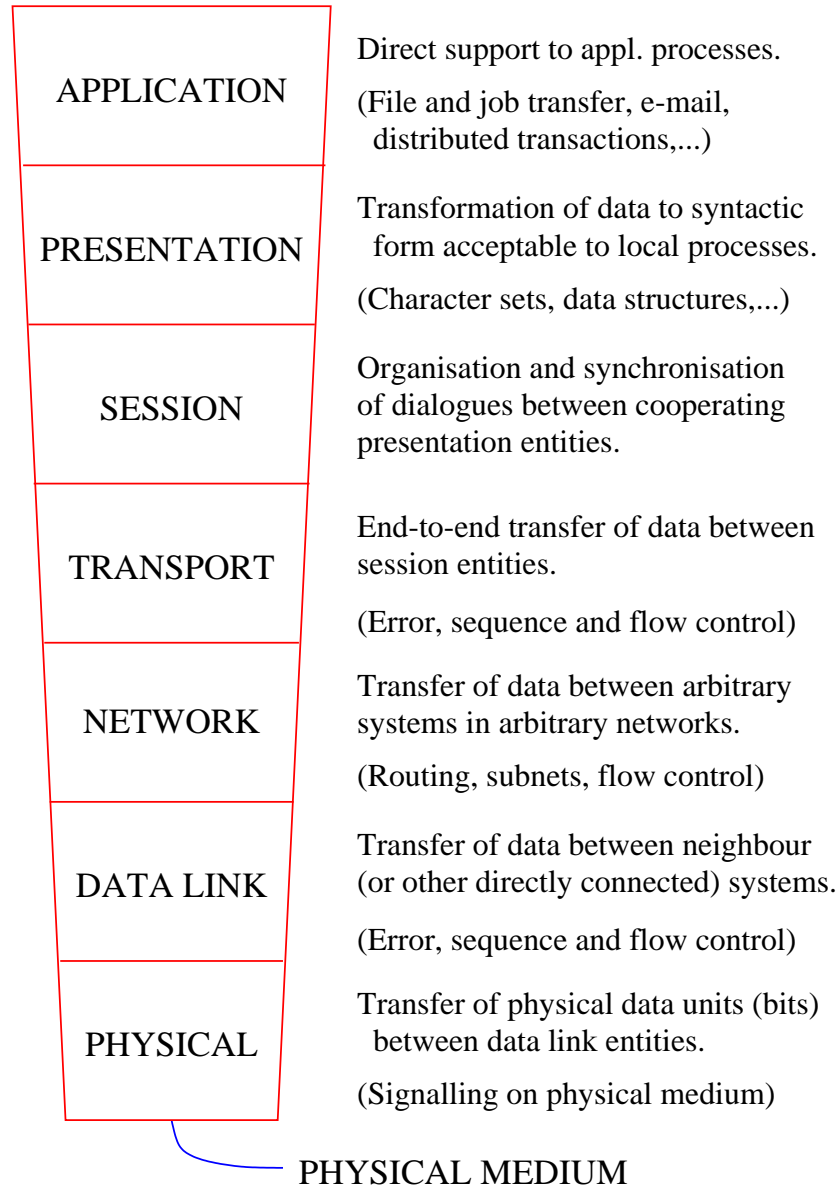

Figure 3.2: The OSI Reference Model: The 7 layers

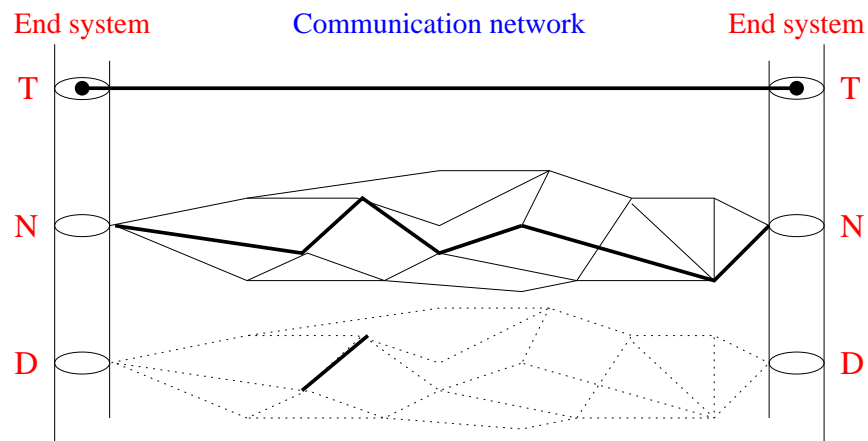

Figure 3.3: Views of a computer network as seen from the Transport, Network and Data Link layers

through a sequence of nodes which *are* pairwise directly connected. These facilities are provided by the Network layer, which also makes it possible to link together subnetworks which may use completely different technologies, as for example a WAN and a LAN.

While the Network layer makes it possible to send data to arbitrary systems in the network, this is not in general enough to provide the type of communication service required by a typical application. Applications are usually built up based on the abstraction that a set of application processes, possibly running in different end systems, communicate directly with one another. The Network layer only provides the abstraction that the relevant *nodes* are connected. To provide the illusion of a channel which directly connects processes running on the nodes, a layer which offers so-called *end-to-end* data transfer services is required. This is the function of the Transport layer, which allows us to:

- Multiplex several logical communication channels onto a single Network channel between two nodes;
- Perform error control on an end-to-end basis on each of the channels separately;
- (Possibly) control the flow of data on an end-to-end basis on each of the channels separately.
- Hide the details of the network or set of interconnected networks which are being used.

The relationship between the Data Link, Network and Transport layers is illustrated in Figure 3.3.

On the basis of the end-to-end data transfer service offered by the Transport layer, the upper three layers provide services intended to support a large variety of applications. At the Transport layer level, the ‘data’ being transferred is still regarded as just a collection of bits. The upper layers make sure that these bits provide the application with meaningful

data in a form which the application can understand. The Session layer is used to organise dialogues between two or more parties involved in an application, the Presentation layer converts data into a representation which the application in the receiving system can understand, and the Application layer offers functionality such as transfer of files or coordination of parallel activities, which are required in general by applications, or facilities such as mail or Web transfer required by particular applications. We shall look more closely at some examples of particular Application protocols later in these notes. Note that the application itself is – like the physical medium – not covered by the model. The application processes are to be considered as *users* of the facilities offered by the Application layer.

The importance of the OSI Reference Model is that it introduced a *standard architecture* and a *standard notation* for many concepts related to data communication. The terms given in italics above are examples of terms introduced in the model. That, for example, there are seven layers is relatively unimportant, and the explanations of why there should be exactly seven are mostly entertaining rather than strictly technical. In practice, for descriptive purposes some of the layers (particularly the Data Link, Network and Application layers) are often divided into *sub-layers*, while implementations, on the other hand, often implement several layers as a single unit.

3.2 Other layered architectures

The OSI Reference Model architecture is not the only layered architecture which you may meet in communication systems. Several commercial manufacturers have developed products which are structured in a similar way. Well-known examples are IBM's SNA architecture and Digital's DECNET. Naturally, the protocols used are not in general the same as OSI protocols, and the layers do not always correspond exactly to the OSI ones, especially in the so-called Upper Layers: the OSI Session, Presentation and Application layers.

A particularly common alternative arrangement is to consider the three upper layers as one unit, an 'Application-oriented layer' which depends directly on the Transport layer. A well-known example of this approach is found in the so-called *Internet protocols*, commonly used in Unix-based systems. Here, a whole series of application protocols – for example, for file transfer (FTP), electronic mail (SMTP), handling virtual terminals (TELNET) and information retrieval (HTTP) – run directly over the Transport layer, while the standard OSI layer structure is used for the Network layer and below. This is illustrated in Figure 3.4. Similar arrangements are often found in local area networks, where OSI protocols are used up to the Transport layer, while the architecture and choice of protocols in the Upper Layers deviates from the OSI standards.

Finally, in modern telecommunication systems, a somewhat different layered architecture can be found in systems based on ATM (Asynchronous Transfer Mode), a technology for

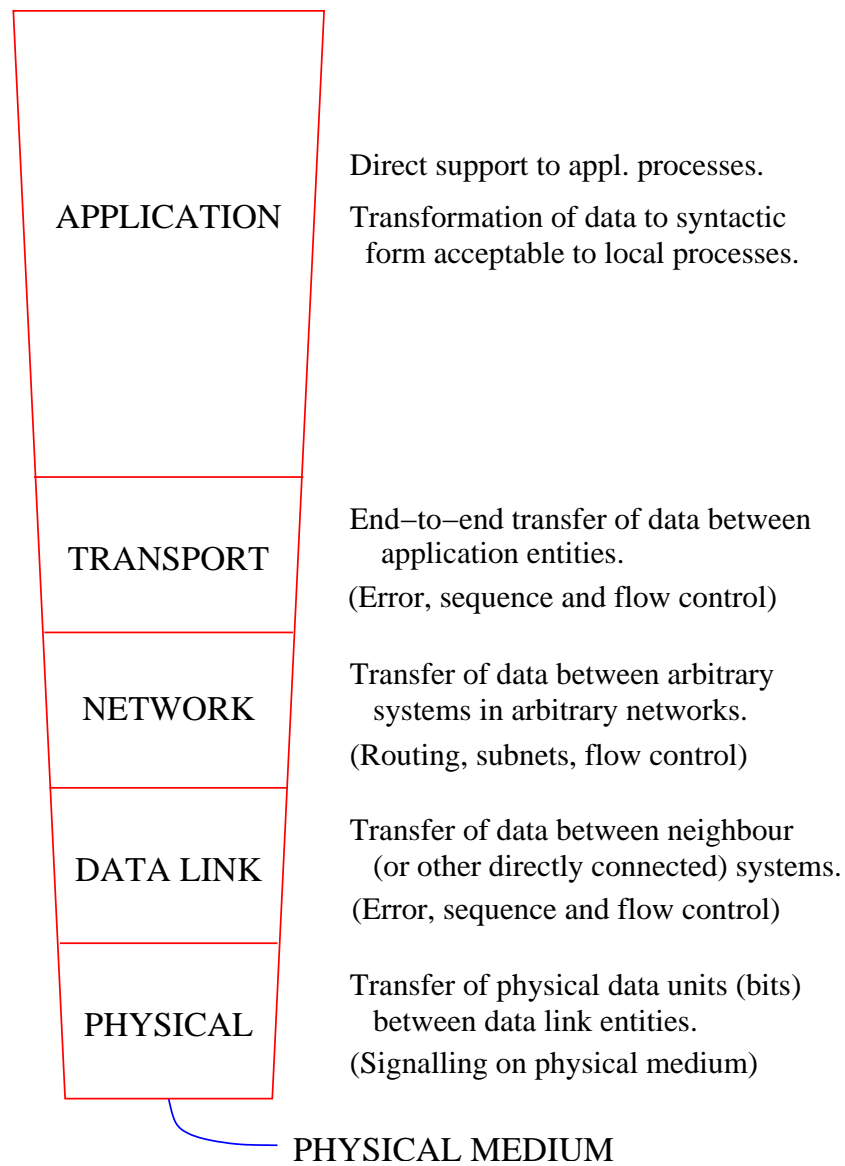

Figure 3.4: The layered architecture used in the Internet

supporting high-speed transfer of data over a local area or wide area network. This architecture is described by the *Broadband ISDN Protocol Reference Model (B-ISDN PRM)* [28]. In this model, although the layers roughly correspond to the OSI RM, there are several important technical differences, especially with respect to the way in which control and signalling information is transferred: In OSI, it forms part of the ordinary data flow; in B-ISDN, it is transferred over a separate connection.

4 Services and Protocols

The *service* offered by a layer describes the facilities offered by the layer viewed as a ‘black box’. In other words the service describes what the layer offers without telling us how this is achieved. The *protocol* is the set of rules for how to behave in order to offer the required service. This is analogous to concepts used in program design: the service corresponds to a description of an *interface* and the protocol to its *implementation*.

4.1 Services

Properties of services fall into two general classes, one concerned with the logical operation of the service (“what does it do?”), and the other with its economy (“what does it cost?”). In these notes, we shall only look at the logical properties of services. Important ones include:

- Sequence preservation
- Data unit synchronisation
- Freedom from error
- Connection-orientation
- (N)-peer operation
- Simplex/duplex/multiplex operation
- Expedited data
- Security

Let us look at these concepts in turn.

4.1.1 Sequence preservation

In a service which offers *sequence preservation*, messages sent by a sender are received in the *same order* as they were sent. This property of a service can be extremely important to some types of service user. For example, in an application in which video frames are to be

transferred from one system to another for immediate display, it would be very inconvenient if the frames arrived in a different order, as the application would then itself have to manage the task of buffering and re-ordering them before display. Likewise, changes to a database should not arrive in a different order than the one chosen by the user. On the other hand, for an application which transfers numbered disk blocks from one system to another, in order to maintain identical copies of a disk on two systems, sequence preservation is often irrelevant.

4.1.2 Data unit synchronisation

In a service which offers *data unit synchronisation*, there is a one-to-one correspondence between the messages passed to the service for transmission and the messages delivered to the receivers. In other words, each message supplied by a user for transmission will – if it arrives at all – be delivered to the intended receiver(s) as a unit. Such services are sometimes called *message oriented services* or *block oriented services*, as they deliver blocks of data in their entirety.

A common alternative is for the service to be *stream oriented*. This means that the boundaries between units of data supplied to the service are not necessarily preserved when the data are delivered to the receiver. Data are regarded as making up a (potentially endless) *stream*, which can be chopped up and delivered in units of any convenient size.

4.1.3 Freedom from error

An *error-free* service delivers the same messages as those which are sent off, without loss or corruption of any kind. In communication systems, the basic types of error are:

Message loss: the receiver fails to receive a message which has been sent by the sender.

Message corruption: the receiver receives a message which differs from that sent by the sender.

Spurious message: the receiver receives a message which has not been sent by the (apparent) sender.

Other types of error, such as duplication or misdelivery of messages, can be expressed as combinations of these basic error types.

A service is often described in terms of its *error rate*, which roughly speaking is the number of erroneous units of data as a fraction of the number of units of data which the sender tries to send. Common measures of this are:

- *Bit Error Rate (BER)*, measured as the number of bits which are in error as a fraction of the total number of bits sent.
- *Residual Error Rate (RER)*, measured as the number of erroneous blocks of data as a fraction of the number of blocks sent:

$$RER = \frac{N_l + N_c + N_u}{N_s + N_u}$$

where N_s is the number of blocks sent by the sender, N_c the number of corrupted blocks received, N_l the number of lost blocks and N_u the number of spurious blocks received by the receiver (but not sent by the genuine sender).

4.1.4 Connection-orientation

In a *connection-mode* service, the users of the service have to establish a *connection* with one another before they can exchange ‘real’ data. The connection is a logical channel through which the real data will be sent, and is set up by exchange of particular types of message in a so-called *connection establishment* phase of communication. This is followed by the *data transfer* phase of communication, in which actual data are exchanged, and finally by a *connection release* phase, in which the connection is broken. For a reliable service, connection release will of course be something which the users decide voluntarily to do; an unreliable service can also produce involuntary release of a connection (in OSI jargon known as a *Provider Abort*). You probably recognise this style of operation from the ordinary telephone service, which is the archetypal example of a connection-oriented service, where you have to set up the connection before you can exchange ‘data’. In the case of an old-fashioned telephone the data will of course be in the form of digital or analog encoded speech; in more modern systems other possibilities may also be available.

The alternative to this mode of operation is seen in a *connectionless-mode* service. Here, it is not necessary to set up a connection before exchange of data. Essentially, each message is then sent independently of the others, and the service has no memory of what has been sent previously to the same destination. The obvious analogy here is to the postal service: when you send a letter, you do not need to set up an agreement with the intended receiver before you post the letter. Obviously, this mode of operation requires less administration, in the form of connection establishment. The downside is that, since you have no guaranteed logical channel through to the intended receiver, there is no way of guaranteeing that messages will arrive in the same order as they were sent – or even that they will arrive at all. A common nickname for this style of service is *send-and-pray* ! Moreover, much of the information transmitted during connection establishment, such as the address of the intended receiver and other properties to be supplied by the service, will have to be repeated *for each message* when a connectionless-mode service is used.

4.1.5 Multi-peer operation

In a service which offers *point-to-point operation*, only two users are involved, and they can communicate with one another. In the simplest case, the two parties have equal status, and we speak of a *two-peer* or *peer-to-peer* service. Later in these notes, we shall see that there are other important forms of two-party communication, for example in client-server systems, where the parties have different status.

In a service which offers *multi-peer* operation, several users can communicate with one another during an instance of communication. Multi-peer services fall into various classes, depending on the pattern of communication which can be achieved:

Broadcast: All available users of the service receive a message sent by one of them.

Multicast: The sender can select a particular subset of users (often known as a *multicast group*) who are intended to receive a particular message or messages.

Inverse broadcast: A single receiver can receive simultaneously from all the other service users.

4.1.6 Simplex/duplex/multiplex operation

A service which offers *simplex* operation is able to transfer messages in one direction only through a logical or physical channel. In *duplex* operation, messages can pass in both directions. If they can pass in both directions at once, we speak of *full duplex* operation; if in one direction at a time, *half duplex* operation.

A *multiplex* service offers access to many users at once by providing some mechanism for sharing the service between them. A duplex service is a special case of this, where there are only two users who share the service, sending in different directions.

4.1.7 Expedited data

Expedited data is an OSI term for data to be transferred with high priority. By definition, expedited data will arrive not later than ‘ordinary’ data sent subsequently to the same destination, and may arrive before ordinary data sent to the same destination at an earlier instant of time. Note that this is *not* a guarantee that they will arrive before ordinary data sent at the same time! In Internet protocols, the term *urgent data* is used for essentially the same concept.

To model this, we can model the service as containing a prioritised queue for the messages in transit, so that queue elements sent via the expedited data service can overtake those sent via the normal service. Obviously, this is in conflict with the concept of sequence

preservation for messages sent between two service users, seen from a universal point of view. But the individual services (normal and expedited) may each possess the sequence preservation property when considered separately.

Although the OSI term is confined to a single high-priority service, the concept can be generalised to cover arbitrary numbers of priority levels. This type of service is commonly offered at the hardware level in Local Area Networks. Examples are the ISO/IEEE Token Bus [12], which offers four levels of priority, and the ISO/IEEE Token Ring [13], which offers eight levels.

4.1.8 Security

A *secure* service is one which prevents unauthorised persons from obtaining access to data transferred by it. This means that data cannot be read or altered by parties other than the intended sender and receiver(s). This is a matter of extreme practical importance, and a great deal of effort has been expended on developing methods to protect data in transit from ‘intruders’.

Various types of security can be identified. A generally accepted classification is:

Authentication: An authenticated service offers its users facilities for confirming that the party which they are communicating with actually *is* the party that they *believe* they are communicating with. You should be aware that this is not trivial in a network, since you cannot really ‘see’ who you are talking to, and have to rely on more indirect methods of identification, which might be faked.

Data Confidentiality: A confidential service provides protection of data from unauthorised disclosure. This protection may, for example, cover:

1. All data sent between users of the service,
2. Particular fields within data (for example, fields containing passwords or keys),
3. Information about the amount of data traffic being transmitted.

The primary mechanism for ensuring confidentiality of data is encipherment, and a study of cryptography is essential for understanding the issues involved.

Data Integrity: A service offering integrity takes measures to withstand active attempts to modify data being passed via the service. As with confidentiality, all data may be protected, or only selected fields.

Non-repudiation: A service with non-repudiation offers undeniable proof that data have been sent or received by a particular service user. *Non-repudiation with proof of origin* prevents the sender from falsely denying that it has sent data; *non-repudiation with proof of delivery* prevents the receiver from falsely denying that it has received data.

Availability: A service which ensures availability is designed to make the service available to (authorised) users at all times. It is not possible for intruders to prevent access by attacking the systems which provide the service. As you may know, typical attacks may come in the form of vira, worms, trojan horses or flooding (so-called *denial of service (DoS)* attacks).

4.2 Quality of Service

The quantitative properties of a service are commonly summarised in terms of a set of parameters collectively known as *Quality of Service (QoS)* parameters. These describe features of the service such as its:

Throughput: The number of bits of data which can be transferred per unit time.

Delay: The time required to:

1. Establish a connection
2. Transfer a data block between sender and receiver
3. Release a connection

Reliability: The probability of failure in:

1. Establishing a connection
2. Transferring a data block between sender and receiver
3. Releasing a connection

Resilience: The probability of unrequested disconnection.

Error rate: The BER and/or RER (as defined above).

Protection: Degree of protection against intruders who attempt:

1. Passive monitoring of information in transit.
2. Active modification, replay, addition or deletion of information in transit.

Priority: This can be understood in two senses:

1. Priority in delivery of data. High priority data is delivered “faster”.
2. Priority in maintaining the requested QoS if the service provider has to degrade the service for some users. A high priority service in this sense is more likely to get what was requested.

QoS parameters are often specified in terms of a target (mean or median) value, together with some indication of the acceptable spread of values, given for example in terms of permissible maximum and minimum values or in terms of a variance. It may also be relevant to specify a (prioritised) list of acceptable discrete values. For example, you might want to state that a service offers (or is requested to offer):

- Throughput: Preferably 128 kbit/s, but otherwise 56 kbit/s.
- Delay in data transfer: 200 ms., +5 ms./-10 ms.
- Resilience: $1 \cdot 10^{-8}$

- BER: $1 \cdot 10^{-9}$.
- Priority in delivery: Highest.

The importance of the various parameters depends strongly on the type of data being transferred by the service. For example, the variation in data transfer delay (often known as the *jitter*) is relatively unimportant for transfer of data such as text files, whereas it is a very important parameter for transfer of continuous media, such as live video or audio in a multimedia application, where variations in the delay can markedly reduce the quality of the user's experience.

4.3 Protocols

A communication protocol is a set of rules which describe how a set of parties are to behave in order to achieve successful communication, which in a layered architecture means that they provide the service which the layer is supposed to provide. Typically the rules specify:

- Which messages are to be exchanged in response to particular events which occur either at the interface to the layer or internally (say in the form of timeouts). Such rules are known as the *rules of procedure* for the protocol.
- The *format and encoding* of the messages for transfer between the participating entities.

In OSI terminology, the messages exchanged as part of the protocol are known as *Protocol Data Units*, or more commonly just as *PDU*s. An initial letter is often used to indicate which layer the protocol belongs to: APDU for Application, TPDU for Transport, NPDU for Network, DPDU for Data Link and so on, or more generally (N)-PDU for a PDU in layer N of a layered architecture. A particular protocol may use several types of PDU; these are usually given descriptive names (Data PDU, ACK PDU, etc.). If you read about non-OSI protocols, you may also find a number of other, rather less precise, terms in use: packets, frames, blocks and so on, somewhat arbitrarily chosen for the individual protocols.

4.3.1 Protocol Control Information

In layer N of a layered architecture, any type of data to be sent between the users of the layer (in layer $N + 1$) must be packed into an (N)-PDU, typically a Data PDU. This will contain the data supplied by the user, together with information known as *Protocol Control Information* (or just *PCI*), which is needed to control the exchange of PDUs according to the rules of the protocol. For example:

- Information identifying the source and destination of the PDU.

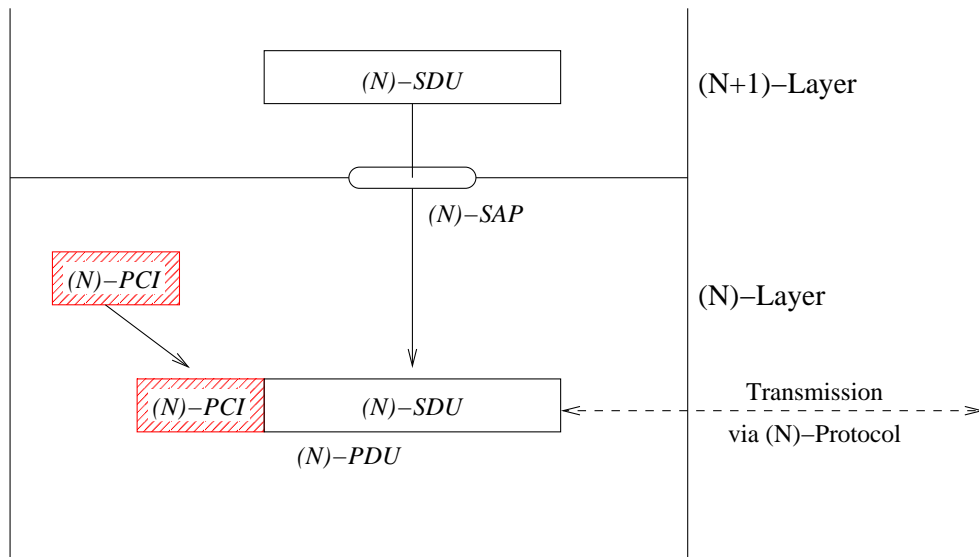

Figure 4.1: Embedding of a data unit supplied by the user into a PDU

- Sequence numbers, used to detect missing or misordered PDUs.
- Checksums, used to detect corruption of PDUs.
- Timestamps, used to detect stale information.

This is illustrated in Figure 4.1.

The figure illustrates a simple case, where the amount of data supplied (in the figure denoted the *Service Data Unit* or *SDU*, in accordance with OSI notation) can conveniently fit into a single PDU, and where all the PCI is added as a *header* at the start of the PDU. In more complex cases, some of the PCI may appear in a *trailer* at the end of the PDU², or it may be necessary to:

- Divide the data in the SDU up among several PDUs. This is usually known as *segmentation* or *fragmentation*. The opposite process, known as *reassembly* takes place in the receiver, in order to recover the entire SDU with all its parts in the correct order.
- Include several SDUs in a single PDU. This process, known as *packing*, may be convenient for efficiency reasons. The receiver will then have the task of *unpacking* the SDUs for delivery to the users.

Some types of PDU, used for purely administrative purposes such as acknowledging receipt of a PDU, do not need to contain data supplied by the service user, and thus consist solely of PCI.

²this is often convenient for checksums as the entire PDU usually has to be processed in order to evaluate the checksum.

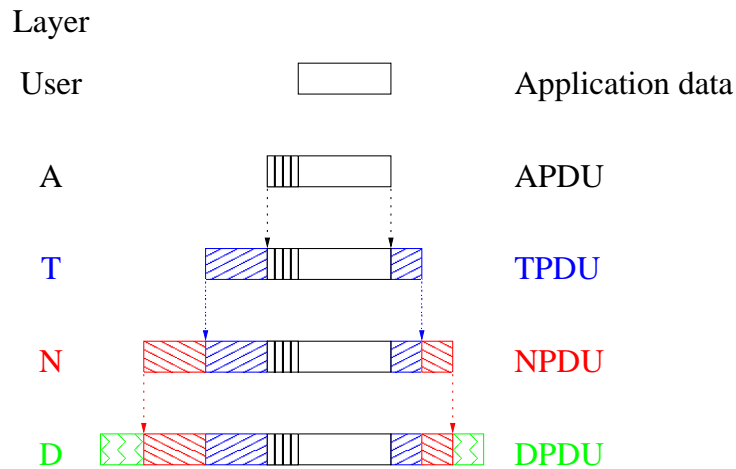

Figure 4.2: Embedding of application data in PDUs in a layered architecture

4.3.2 PCI in a layered architecture

Since PCI has to be added in each layer of a layered architecture, in order to suit the rules of the various protocols in use, it should be clear that the actual data being exchanged by an application can be embedded in a large amount of headers and trailers originating in the various layers. A simple example of this is illustrated in Figure 4.2, where we imagine an Internet-style layered architecture with an Application layer supported directly by the Transport layer. In a full OSI architecture, two more layers of PCI, from the Session and Presentation layers, have to be added. The actual application data are first embedded in an APDU to be exchanged using the chosen Application layer protocol. This APDU becomes data to be sent in a TPDU to be exchanged using the chosen Transport layer protocol, and so on.

Figure 4.2 shows the simplest case, in which each (N)-PDU fits into the payload of a single (N-1)-PDU. In many practical cases, this may not be possible, as the rules of the protocol may prescribe a maximum length for the PDUs which can be sent. If the (N)-PDU cannot be embedded into a single (N-1)-PDU, then it must be segmented into several (N-1)-PDUs. An example of what might happen is shown in Figure 4.2. Here the APDU is divided among two TPDU's, each of which gives rise to a single NPDU, of which the first has to be segmented and sent as two DPDU's, while the remaining one fits into a single DPDU.

A commonly observed practical consequence of this is that the effective data rate available for transfer of application data may drop suddenly when the application data reach a certain critical size. Whether (and when) this happens depends on the maximum PDU sizes dictated by the individual protocols in use in the protocol suite.

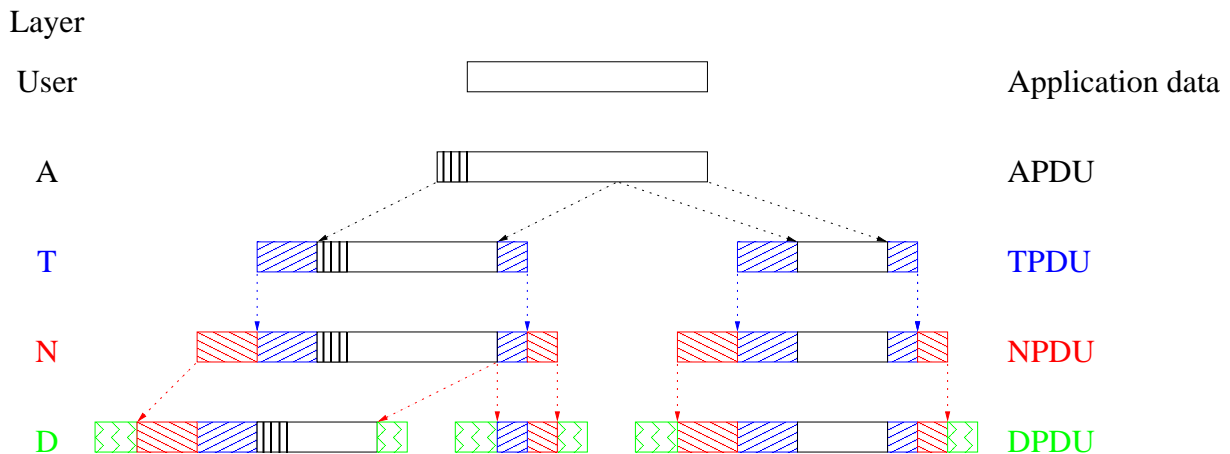

Figure 4.3: Embedding of application data in PDUs in a layered architecture where segmentation is necessary

4.3.3 A simple data transfer protocol

As an example, suppose we wish layer N to provide a connectionless, block oriented data transfer service for its users (in layer $N + 1$). A very simple data transfer protocol in layer N for this purpose might specify:

1. Rules of procedure:

- If a user in layer $N + 1$ requests transfer of a block of data b to a destination d , this block will be embedded in a DATA PDU and transmitted to d via the service provided by layer $N - 1$.
- If a DATA PDU with a correct checksum is received from source s , an acknowledgment formatted as an ACK PDU will be sent back to s via the service provided by layer $N - 1$.
- If a DATA PDU with an incorrect checksum is received from source s , it will be ignored, i.e. no action will be taken and no acknowledgment sent.
- If no acknowledgment is received by the sender within a time T after the transmission of a DATA PDU, the sender will retransmit the PDU via the service provided by layer $N - 1$.

2. PDU formats:

- A DATA PDU containing data b to be sent from source s to destination d will be formatted as shown in Figure 4.4(a), where t is the 8-bit sequence 10000001, s and d are represented by 32-bit IP addresses, l gives the number of octets³ of data in b expressed as a 16-bit unsigned binary number, and c is a 32-bit checksum field evaluated over all the other fields of the PDU according to the CRC-32 algorithm.

³8-bit units

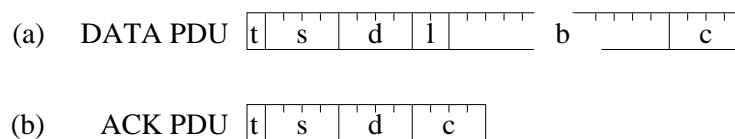

Figure 4.4: Example formats for two PDU types

The PDU types and field names refer to the example in the main text.

- An ACK PDU to be sent from destination d to source s will be formatted as shown in Figure 4.4(b), where t is the 8-bit sequence 10000010, s and d are represented by 32-bit IP addresses, and c is a 32-bit checksum field evaluated over all the other fields of the PDU according to the CRC-32 algorithm.

More complicated rules of procedure and a greater variety of PDU formats can be expected to occur in more realistic examples. In such cases, a more formal notation than ordinary prose is often preferred, in order to achieve a concise description with a high degree of precision. Most such notations are based on one of two principles for describing the behaviour of the protocol:

1. In terms of a state machine, which reacts to incoming events and produces outgoing events. Two well-known internationally standardised languages based on this principle are SDL (standardised by the International Telecommunications Union, ITU-T [29]) and ESTELLE (standardised by the International Organization for Standardization, ISO [11]).
2. In terms of a set of interacting processes which exchange messages. Process algebraic languages such as CCS [30] and CSP [8], and the language LOTOS (standardised by ISO [10]) are typical examples of notations which have been used with this approach.

5 Network Technology

These notes will not deal in any depth with network technology, and if you need to know more you will need to look at some of the more technology-oriented references. However, we shall try to explain what some of the commonly used terms mean, so that you understand what the salesman is talking about when he calls to sell you some network equipment.

Referring back to the introductory section on computer networks, you may be wondering what exactly the communication nodes and the end systems consist of, and how all this fits into the scheme of the OSI Reference Model (or its Internet variant). One typical answer is shown in Figure 5.1. In this example, the communication nodes implement the OSI layers up to and including the Network layer, and are thus responsible for:

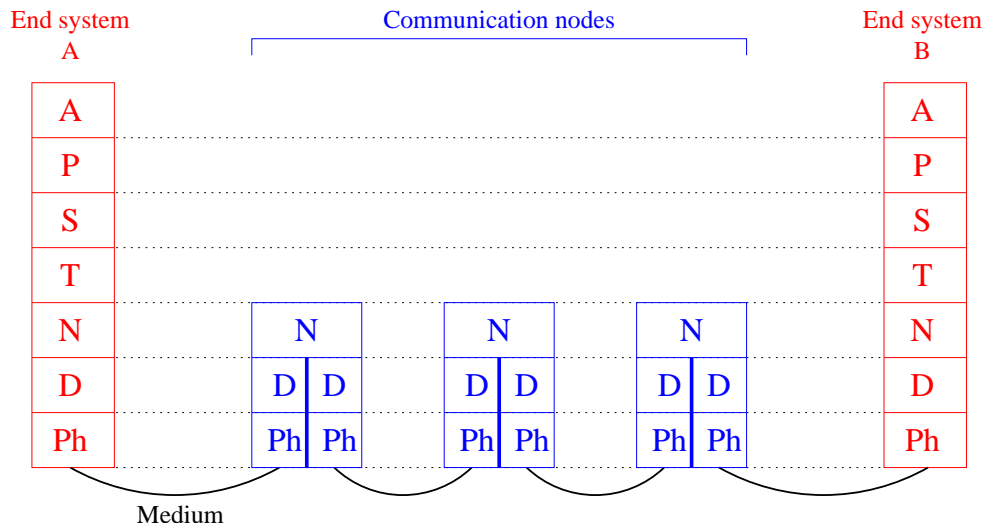

Figure 5.1: Layers in the communication nodes and end systems in a computer network

- Accepting PDUs on an incoming link from another node at the Data Link level.
- Routing these PDUs to an outgoing link at the Network level.
- Transmitting PDUs on an outgoing link to another node at the Data Link level.

Sending or receiving PDUs at the Data Link level of course requires the node to activate the facilities of the Physical layer in order to deal with the task of signalling on the physical medium.

5.1 Routers

A node which implements the layers up to the Network layer and is capable of choosing a suitable route for sending an NPDU on to its destination is known as a *router*. Although this cannot be seen in Figure 5.1, a router will in general have a larger number of links to deal with than just two – otherwise there would be no need to make any choices about which route to take. You should refer back to Figure 3.3 for a view of the computer network which should make this more clear.

When routing decisions have to be made, most routers are also able to decide that certain PDUs are *not* to be passed on to the destination which has been specified for them. This activity of removing irrelevant PDUs is known as *filtering*. Typical reasons for doing this include:

- The router can determine that the destination cannot be reached via any of the outgoing links from the router.

- The router can determine that data from the given (or apparent) source is not desired by the specified destination system.

A router which can be programmed to refuse to pass traffic from certain sources or addressed to certain destinations or for use by certain applications is often simply known as a *filter*. Since this type of filtering also acts to protect the systems in the network from certain types of ill-intentioned traffic, filtering is one of the functions typically found in a *firewall* intended to protect a network or subnet from attack by intruders such as hackers. Many modern routers in fact combine the functions of a router and a firewall in the same piece of equipment.

5.2 Bridges

From Figure 5.1 you might get the impression that there is always a direct connection (via the Data Link layer) between any two routers in a network. This is not entirely true. Often the subnet (the part of the network) which lies between two routers is, for practical reasons, divided into a series of segments which are joined together by *bridges*. These implement a junction between two parts of the network in the *Data Link* layer, as illustrated in Figure 5.2.

Typical functions of a bridge are:

- To *filter* traffic passing in the subnet, so that parts of the traffic which do not need to pass the bridge in order to reach their destination are prevented from doing so. The purpose of doing this in the Data Link layer is to prevent unnecessary traffic from overloading the individual segments of the network. Since the bridge operates in the Data Link layer, the filtering decision is based on the addresses used to identify systems in this layer (rather than the Network addresses used by the router).
- To *adapt* between different conventions for data transmission used in the Physical layer in different segments which use the same Data Link protocol (see Section 5.3 below). For example, one segment may use electrical signalling on twisted pair cable, while the neighbouring segment uses a fibre optic connection.

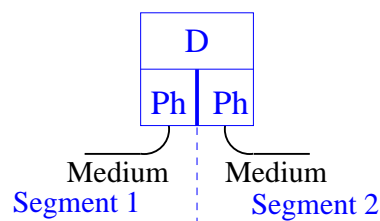

Figure 5.2: A bridge between two network segments

A bridge usually possesses no real routing capability – the kind of *yes/no* decisions made by a filter do not qualify in this respect. However, a bridge will sometimes be a collecting point for several segments of a subnet, and in such a case it will also provide a rudimentary form of routing, in order to pass data on to the appropriate segment.

5.3 LAN Technologies

A LAN is intended to offer data communication facilities over a limited area, such as a single building, a company premises or an institution such as a university department or an entire university. Over such a limited area, it becomes technically feasible to let all the nodes attached to the network have shared access to a common medium, which can be based on cables or wireless facilities covering the area concerned. The Physical Layer technologies are therefore chosen to suit such media, and the Data Link protocols control access to the shared medium. Traditionally, the LAN Data Link layer is conceptually divided into two sub-layers:

1. A lower, technology-dependent *Medium Access Control (MAC)* sublayer, of which we shall look at two examples in detail below.
2. An upper *Logical Link Control (LLC)* sublayer, which is intended to provide a technology-independent Data Link service based on a variety of MAC sublayers.

Most LAN MAC sublayers in current use follow one of the IEEE standards from the so-called *802.x* series, which have been more or less taken over lock, stock and barrel by ISO to form the various parts of the ISO8802 standard. These are summarised in Table 5.1. You will notice that several numbers are missing in the table. Some of the missing items

IEEE	ISO	Technology
802.3	8802-3	Carrier Sense Multiple Access/Collision Detect (CSMA/CD)
802.4	8802-4	Token Bus
802.5	8802-5	Token Ring
802.6	8802-6	Distributed Queue Dual Bus (DQDB)
802.9	8802-9	Integrated Services (IS) LAN
802.11	8802-11	Wireless LAN
802.12	8802-12	Demand-priority Access
802.15	8802-15	Wireless Personal Area Networks (WPAN)
802.16	8802-16	Fixed Broadband Wireless Access (FBWA)

Table 5.1: IEEE and ISO standardised LAN technologies

cover general topics, such as LAN architecture (802.1), Logical Link Control (802.2) and security (802.10); others have just never become standards. Many of the standards also come in several variants, for different Physical Layer data rates or different physical media (or both). We shall see some examples of this in the following sections.

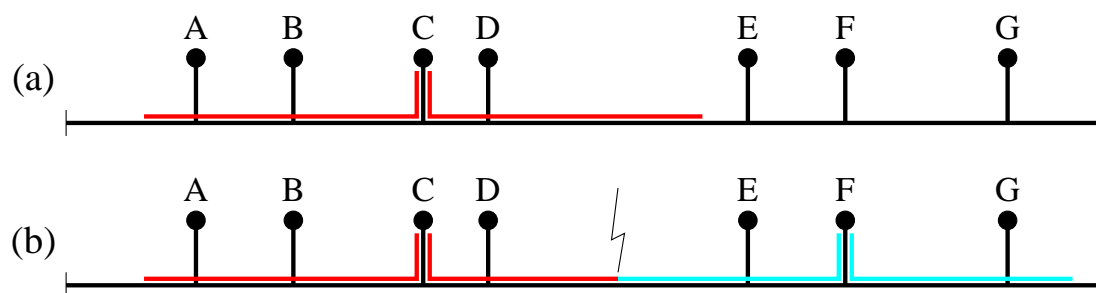

Figure 5.3: Propagation of signals along a shared bus or cable.

- (a) Signals from a single sender (C) propagate along the bus in both directions.
 (b) If two nodes (C, F) try to send at the same time, their signals collide and the transfer of data does not succeed.

5.3.1 CSMA/CD Technology

CSMA/CD technology is nowadays the dominant technology for wired LANs, i.e. local area networks where the signals are transmitted via some kind of cable which is laid out round the building(s) to be covered. Originally, the cable was a thick coaxial cable which could carry data at 10 Mbit/s; subsequently, thinner coaxial cables and shielded twisted pairs of wires have been used, and data rates from 1 to 1000 Mbit/s have become available. The original technology was developed by a consortium of companies, and registered under the trade name *Ethernet*[™]. This name is commonly (but not very correctly) used as a synonym for CSMA/CD, so for example the technology for operating CSMA/CD at 1000 Mbit/s is often referred to as *Gigabit Ethernet*.

CSMA/CD is strictly speaking a MAC protocol, for gaining access to a shared broadcast medium. The cable works in this respect like a computer bus, so signals from any node attached to the medium will propagate in all directions out from the sender until they reach the end of the bus. This is illustrated in Figure 5.3(a) If two nodes try to send at the same time, a *collision* occurs between their signals, as shown in Figure 5.3(b), with the result that the intended receivers cannot make sense of the message.

This problem is a general one in systems based on the use of a shared broadcast medium, where the nodes effectively compete to get access to the medium. The technical term for this type of competition is *contention*. The CSMA/CD protocol introduces two rules for regulating access to the medium to counteract the effects of contention:

CSMA: Listen before sending. If the medium is occupied (indicated by the presence of signals from other nodes), then wait until it is free.

CD: Listen while sending. If signals from other nodes are also detected, then a collision has occurred because several nodes have found the medium free at the same time. Stop sending and wait a random time before trying again.

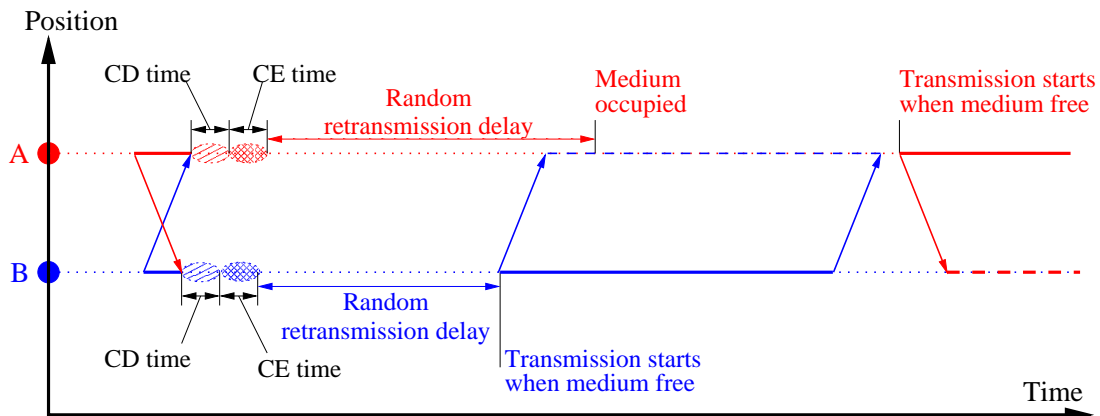

Figure 5.4: Collision Detection and retransmission in the CSMA/CD MAC protocol

The random time is assumed to be chosen differently for each node, so there is a high statistical probability that one of the nodes will find the medium free next time it tries, though obviously this probability gets smaller and smaller as the intensity of the traffic increases. Figure 5.4 illustrates what happens if just two nodes try to send at the same time. In the figure, the *CD time* is the time required for a node to detect that a collision has taken place. Once it has detected this, it sends a special *Collision Enforcement (CE)* signal on the medium to inform all other nodes that the current transmission is worthless. This signal lasts during the *CE time*. After sending the CE signal, the colliding nodes each wait a randomly chosen interval before trying again.

The discussion here has assumed that the shared medium, to which the nodes try to gain access, actually is a cable which runs round the building. This is not always convenient, and many modern Ethernet installations use a *switch*, instead of a passive cable, to connect a set of nodes, as illustrated in Figure 5.5. This technology is often referred to as *switched Ethernet*. If, for example, node C in the figure transmits a PDU addressed to node F, then the switch will try to set up a path directly from C to F.

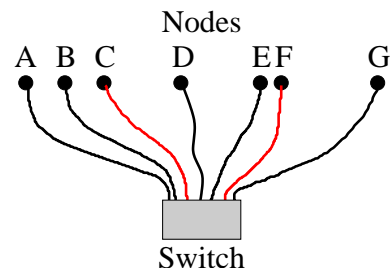

Figure 5.5: A switch connecting seven nodes

If F is busy sending to or receiving from another node, the path cannot be set up, and C must try again later. But if the path can be set up, then C can send the PDU to F at the full data rate allowed by the network technology. The switch enables several pairs of nodes to talk to one another using the full network bandwidth at the same time, thus avoiding much of the contention which arises in the shared medium of a traditional *shared Ethernet*. Of course, there will still be contention when several senders simultaneously try to reach the *same* destination, but if this only happens rarely then switch technology allows you to build a network with an bigger overall data carrying capacity than a shared Ethernet operating at the same data rate.

5.3.2 Wireless LAN Technology

Wireless LAN technology has become very important in recent years, as it offers a convenient way to achieve not just distributed computing but *mobile computing*, where the computing systems are allowed to move physically from one site to another. In a Wireless LAN, signals from transmitting nodes propagate in all directions⁴, and can be picked up by other nodes which are within a certain range, usually somewhere between 25m (inside a building) and 300m (in the open air). There are three basic styles of Wireless LAN, which are illustrated in Figure 5.6. In the BSS architecture, a central, immobile *Access Point*

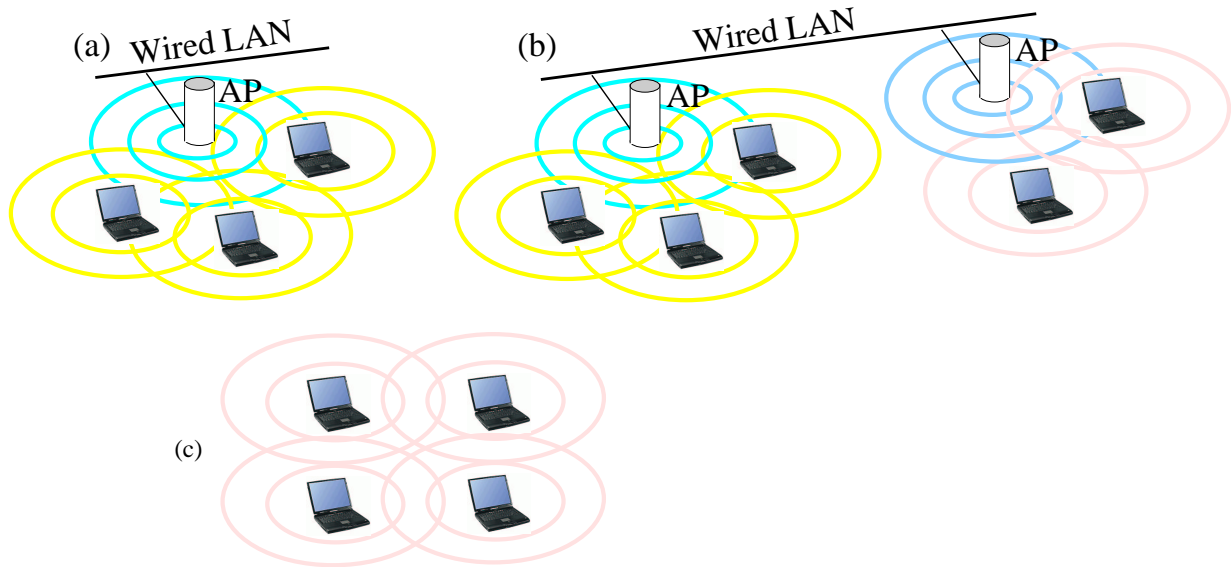

Figure 5.6: Basic architectures of Wireless LANs

- (a) Basic Service Set (BSS)
- (b) Extended Service Set (ESS)
- (c) Ad hoc (IBSS or peer-to-peer)

(AP) performs coordinating functions, and is used as an intermediate station for all traffic between the set of mobile nodes which are within its range. In the ESS architecture, several Access Points are connected by a wired network, thus permitting mobile nodes to keep in contact, as long as they are within range of at least one Access Point. Traffic intended for the different Access Points is typically sent on different radio channels in the frequency band in use. In the Ad hoc architecture, there is no Access Point, and all the mobile nodes communicate directly with one another.

Practical computer systems which make use of Wireless LAN technology are nowadays almost all based on the IEEE 802.11 standard⁵. This prescribes two alternative MAC

⁴At least in principle, since sometimes the sending or receiving antenna is directional.

⁵Actually, it is a family of standards, as we shall see later.

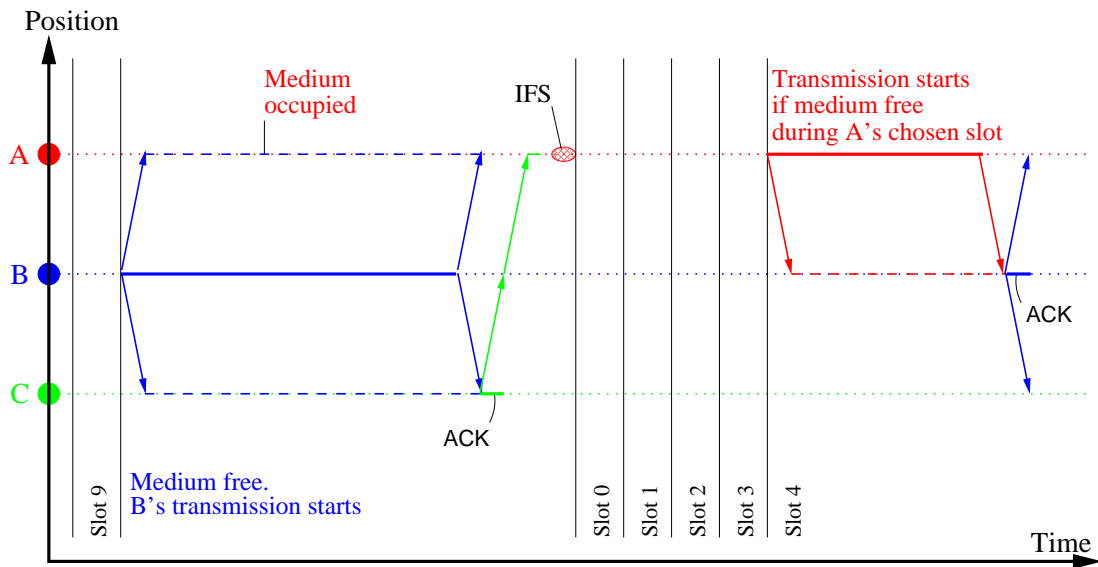

Figure 5.7: Contention Avoidance in the CSMA/CA protocol

IFS is the Inter-Frame Space, a period of silence which separates one transmission from the first reservation slot for the next transmission.

protocols, of which the most commonly used is closely related to the CSMA/CD protocol described above, and is known as the *Carrier Sense Multiple Access/Collision Avoidance (CSMA/CA)* protocol. The *CA* part of the name refers to a slightly different mechanism used to deal with contention: Instead of letting all nodes with a pending transmission send as soon as the channel seems to be unoccupied, and trying to detect collisions, the nodes use a time slot mechanism to choose an instant at which to test whether the channel really is unoccupied. Each node with a pending transmission chooses a slot at random, and the one which chooses the lowest number finds the channel really is unoccupied and thus wins the “race” to be allowed to use the channel. In a wireless network, this is not quite foolproof, as stations may not all be able to hear one another, so the receiving station must send a positive acknowledgment for receipt of a PDU. If the sender receives no ACK, it retransmits the PDU after a new random delay. This is illustrated in Figure 5.7.

The basic 802.11 Wireless LAN standard describes the operation of the Medium Access protocol and three variants of the Physical Layer protocol for:

- Operation in the 2.4 GHz Industrial, Scientific and Medical (ISM) wireless band, using the frequency-hopping spread spectrum (FHSS) technique to achieve a 1 Mbit/s data rate.
- Operation in the 2.4 GHz wireless band, using the direct sequence spread spectrum (DSSS) technique to achieve a 1 or 2 Mbit/s data rate.
- Operation in the infrared band to achieve a 1 or 2 Mbit/s data rate.

As time has passed, this standard has accumulated a considerable number of additional variants and amendments, indicated by extra letters after the number. Some of the ones you are most likely to meet are:

802.11a Describes the operation of the Physical Layer in the 5 GHz wireless band, to achieve a data rate up to 54 Mbit/s.

802.11b Describes the operation of the Physical Layer in the 2.4 GHz wireless band, to achieve a 1, 2, 5.5 or 11 Mbit/s data rate.

802.11e Enhancements to the Medium Access protocol to provide QoS.

802.11g Describes an extension to achieve data rates of 22 or 54 Mbit/s in the 2.4 GHz wireless band.

802.11h Describes extensions to achieve Spectrum and Transmit Power Management, in order to use the 5 GHz band in Europe.

802.11i Describes security enhancements to the Medium Access protocol.

In Europe, important parts of the 5 GHz wireless band are reserved for other purposes, so the 802.11a technology is unlikely to be used (even if 802.11h is followed). Instead, the high data rates offered by 802.11a are likely to be achieved by using equipment which follows the 802.11g standard.

6 Basic Protocols in the Internet

In these notes, most of the examples will be concerned with the kind of protocols used in the Internet. An overview of some of the best known ones can be seen in Figure 6.1. There are no special Internet protocols assigned for use in the Data Link or Physical layers. The protocols in these layers are very technology dependent, and the appropriate choice will depend on the environment in which the network is to operate. For example, if communication takes place within a single building or building complex, it would be natural to base the network on LAN technology, and one of the IEEE 802.x protocols described in the previous section would be used in these layers. If communication is also to extend over a public WAN, an ITU-T protocol suite such as ATM would typically be used; in practice, the choice of protocol in a WAN will be made by the Internet Service Provider (ISP) who offers the IP service, and the user is unaware of what is going on in the layers below the Network layer.

6.1 Internet Protocol, IP

IP is the basic Network layer protocol used in the Internet. The full name of the protocol may cause you some confusion, since the word “internet” has two meanings: When spelt

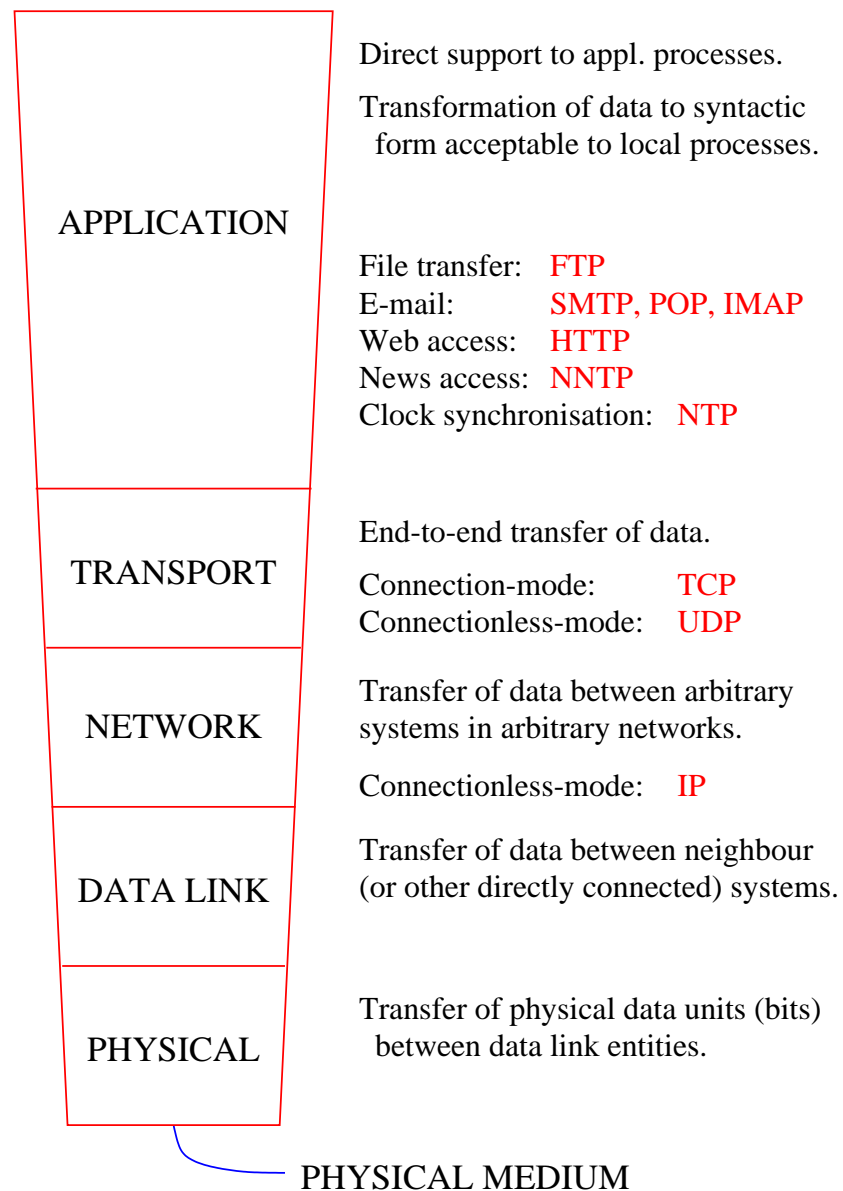

Figure 6.1: Protocols in the Internet layered architecture

with a small “i” it refers to a type of protocol which is used to offer Network layer services over a set of interconnected subnets, possibly based on different technologies, while with a large “I” it refers to the whole concept of the modern Internet. A more correct name for IP would really be “the Internet internet protocol”, but by now it is too late to change!

IP is a connectionless-mode protocol which is used to implement a connectionless-mode, full duplex, point-to-point or multicast stream service for data transfer. IP offers facilities for segmentation and reassembly, and for various forms of routing. It is defined in two versions:

1. “Classic” IP, often known as IPv4, which identifies the source and destination systems by 32-bit addresses. This is described in the Internet document RFC791 which forms part of Internet Standard 5 [17].
2. Internet Protocol version 6, often just known as IPv6, which identifies source and destination by 128-bit addresses and includes more comprehensive facilities for dealing with different classes of traffic, incorporating security, and other features. The protocol is described in RFC1883 [20], and the addressing scheme in RFC2373 [26].

Most current ISPs support IPv4, but a considerable international effort is currently going into the deployment of IPv6. An important reason for this is that the number of systems attached to the Internet is increasing so rapidly that the supply of 32-bit addresses used in IPv4 is running out.

The format of an IPv4 PDU is shown in Figure 6.2. The *header* consists of all the fields from the version number up to and including the padding, while the rest of the PDU contains the *payload data*, normally a PDU from some higher level protocol such as TCP or UDP. The *Protocol* field contains information about which higher level protocol it is: for example, the value 6 indicates TCP and 17 UDP. The length of the header (in units of 32-bit words) is given by the *Header Length* field, while the *Total Length* field gives the length of the entire PDU in octets (8-bit units). The *Type of Service* field contains information which in principle specifies the quality of service to be offered to the PDU, although very few IPv4 routers actually handle this field in practice. The *Fragment Information* field contains two 1-bit flags which indicate whether fragmentation may take place and whether this PDU contains the last fragment or not, followed by a 13-bit sub-field giving the position of the fragment in the unfragmented original, measured in units of 8 octets, where the first fragment starts at octet 0. The *Time-to-Live* field is used to ensure that the PDU will be thrown away if it does not reach its destination within a certain period of time. It is initialised to the maximum acceptable lifetime for the PDU (in seconds), and decreased by at least one second in every network node through which the PDU passes; if the PDU spends more than one second in the node, the field is decreased by the time actually spent. If the field reaches zero, the PDU is discarded. Finally, the PDU may contain a number of *Option* fields, which specify information about which route is to be taken to the destination, record information about the actual route, specify security parameters or

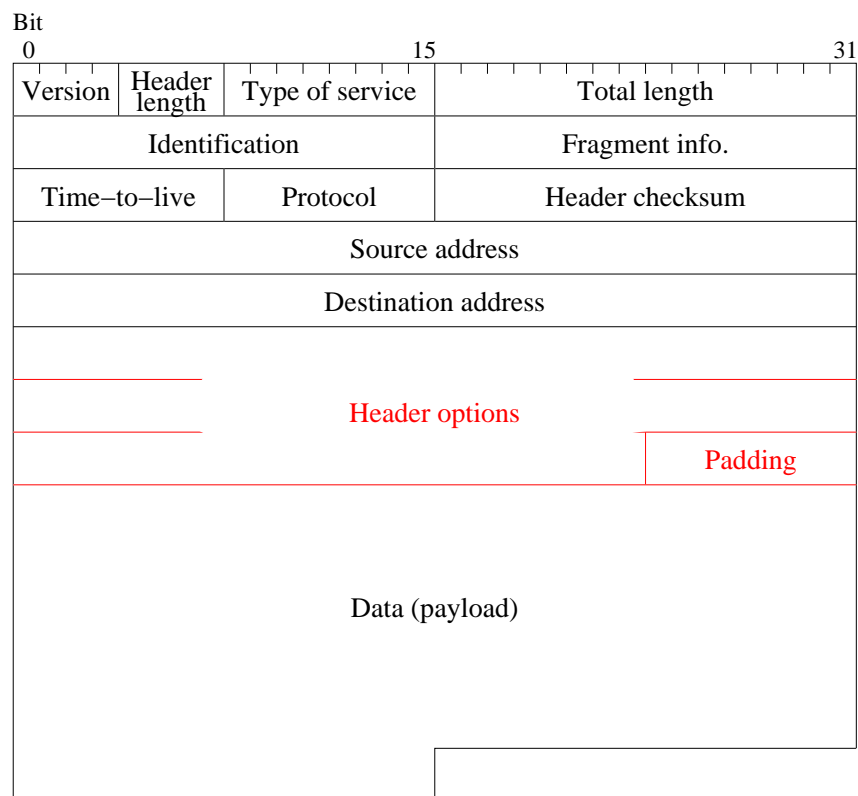

Figure 6.2: Format of an IP version 4 PDU

carry timestamps. The *Padding* field contains a number of 0-bits which ensure that the options (and therefore the header as a whole) fill an integral number of 32-bit words. For full details, you should look at RFC791 [17].

6.1.1 IP Addresses

An IP address designates a system in a network which operates according to Internet conventions⁶. IP addresses can be allocated to a system *statically* by a system manager when the system is set up, or *dynamically* from a pool of available addresses when the system is booted. The dynamic method requires you to have access to a server which can supply your system with a currently free IP address. To contact this server, the operating system uses the *Dynamic Host Configuration Protocol (DHCP)* [25], and the server is therefore usually called a DHCP server.

IPv4 addresses are traditionally written as a sequence of four decimal numbers separated by dots, for example 130.225.76.44, where each number lies in the range [0..255] and is the decimal value corresponding to 8 bits of the address. IPv6 addresses are correspondingly written as a sequence of 8 hexadecimal numbers separated by colons, where each number corresponds to 16 bits of the address. Both IPv4 and IPv6 addresses are structured, with the leading bits of the address denoting the network or subnetwork in which the node is placed, and the trailing bits denoting the particular system (well: interface) within this network. How many bits are used for each purpose depends on the so-called *class* of the network, where the class reflects some (historical) idea about how many end systems the network is likely to host. The scheme for IPv4 addresses is shown in Figure 6.3. A subset of the IP addresses in each class are allocated for use in systems which will *not* be connected to the Internet. These are known as *Private Network (PN)* addresses, and are of course not globally unique: There can be many systems with the address, say, 192.168.25.1 in the world!

The number of bits which identify the network (or indicate that the address is the address of a multicast group) is often specified by a so-called *netmask*, which is the pattern of bits which can be used to remove the *host id* or *multicast group id* part of the address. This is summarised in Table 6.1. When you connect a system to the Internet, you usually need to supply a value for the netmask to be used in your part of the network.

⁶Strictly speaking the address designates not the node or system itself, but a network *interface* in the node, which in practice means that it is associated with a network adapter card. So if your system uses several network cards at the same time, it will normally use several IP addresses.



Figure 6.3: IPv4 addresses (above) and Private Network addresses (below)

Address Class	Length of Network id	Netmask
A	8	255.0.0.0
B	16	255.255.0.0
C	24	255.255.255.0
Multicast	4	240.0.0.0

Table 6.1: IPv4 address structure and netmasks

6.1.2 Internet Names

Finally, you may be wondering how the IP addresses are related to the Internet *host names* which turn up in mail addresses, Web addresses and so on. For example:

```
www.rfc-editor.org
hobbits.middle-earth.net
esmeralda.imm.dtu.dk
stop.it
```

Like an IP address, a name identifies a system (interface), but it has no fixed length and its structure reflects the *administrative domains* which are responsible for allocating the name. The elements of the name are given in order of increasing significance, separated by dots. For example, `www.rfc-editor.org` refers to the the system `www` within the sub-domain `rfc-editor` within the top level domain `org`. The top level domain is usually a two-letter code referring to a particular country (`dk`, `it`, `uk`, `ru`,...) or the name of a general class (`org`, `net`, `com`,...) with its own *naming authority* responsible for allocating names. The mapping between names and the corresponding addresses is maintained via the *Domain Name Service (DNS)*, a large distributed database from which information can be retrieved by using the DNS Application layer protocol. This is a client-server protocol, and when you attach a system to the Internet, you usually need to supply the IP address of the DNS server which your system (as client) will ask first, when it needs to find the IP address corresponding to a given name. If this server does not know the answer, it will pass the query on to other DNS servers, and so on.

6.2 Transmission Control Protocol, TCP

TCP is one of several Transport layer protocols in common use in the Internet, and is described in Internet RFC793, also known as Internet Standard 7 [18]. TCP is a connection-mode protocol which is used to implement a connection-mode, full duplex, point-to-point stream service for data transfer, based on a connectionless-mode Network service, as provided by IP. For traffic between a source identified by IP address *IPs* and a destination identified by *IPd*, TCP makes it possible to set up a large number of connections distinguished by so-called *port numbers*. This provides a form of multiplexing, as illustrated in Figure 6.4. Port numbers are integers in the range [0, 65535]. Many of the smaller port numbers (up to 1023) are officially *assigned* for use by standard Internet application servers. Attempts to make a connection to assigned ports should only be made in order to run the appropriate application protocol. Ports from 1024 up to 49151 can be *registered* with an organisation known as the *IANA* for use with specific applications, while those from 49152 and up can be used freely, for example when ports have to be *dynamically allocated*. This is a common strategy at the *client* end of a client-server connection.

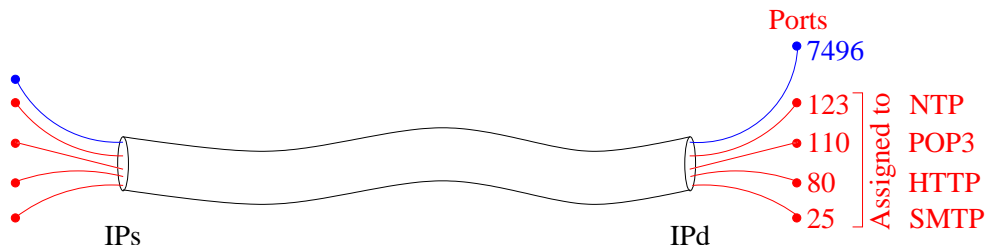

Figure 6.4: TCP ports used for multiplexing traffic between two IP addresses

Since TCP is a connection-mode protocol, a TCP connection needs to be set up between two suitable ports before data can be transferred. When one or other of the communicating parties has finished sending data, it is allowed to initiate closing the connection, a process which is completed when the other party acknowledges that the connection is closed. In between these two phases – of setting up and closing the connection – full duplex exchange of data is possible.

TCP is a stream-oriented protocol, so the data transferred in each direction is considered as a potentially unlimited stream of octets, whose position in the stream is identified by consecutive *sequence numbers*. The initial sequence number for the first octet of data to be sent in a given direction is agreed when the connection is set up. All subsequent TCP PDUs which carry data, say from A to B, contain:

- A *sequence number*, n_s , which gives the number (modulo 2^{32}) of the first octet of data in the PDU;
- An *acknowledgment*, ack_r , which gives the sequence number (modulo 2^{32}) of the next octet expected from B. This implicitly acknowledges correct receipt of all the octets with numbers up to and including $(ack_r - 1)$.
- A *credit value*, W_r , which gives the number of data octets which A is willing to receive from B. In effect, this says that the sender of the PDU is willing to receive octets with numbers from ack_r up to $(ack_r + W_r - 1)$. W_r is often known as the (*receive*) *window size*.

Figure 6.5 illustrates the principle of such a *window protocol*. These mechanisms make it possible to check for missing parts of the stream of data, acknowledge received data and control the flow of data received from the other party. A checksum in the PDU header allows the receiving party to check that the PDU has not been corrupted in transit. All in all, TCP offers a reliable connection-oriented service to applications.

The actual PDU is encoded as shown in Figure 6.6. There is only one format for PDUs, but six *control flags* are used to differentiate between various purposes for which the PDU may be used:

SYN: Sender is in the process of opening the connection and wishes to synchronise se-

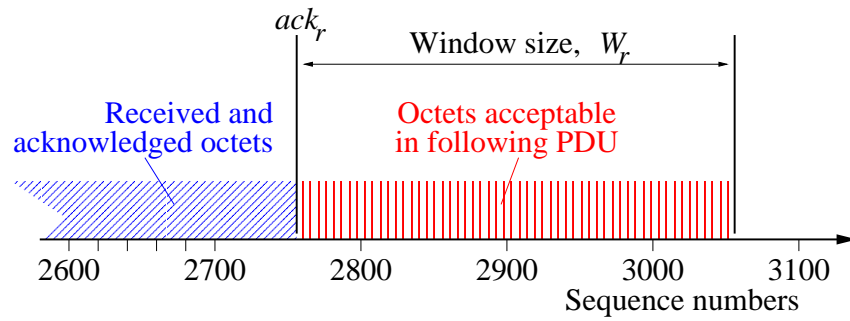

Figure 6.5: Operation of the receive window in TCP

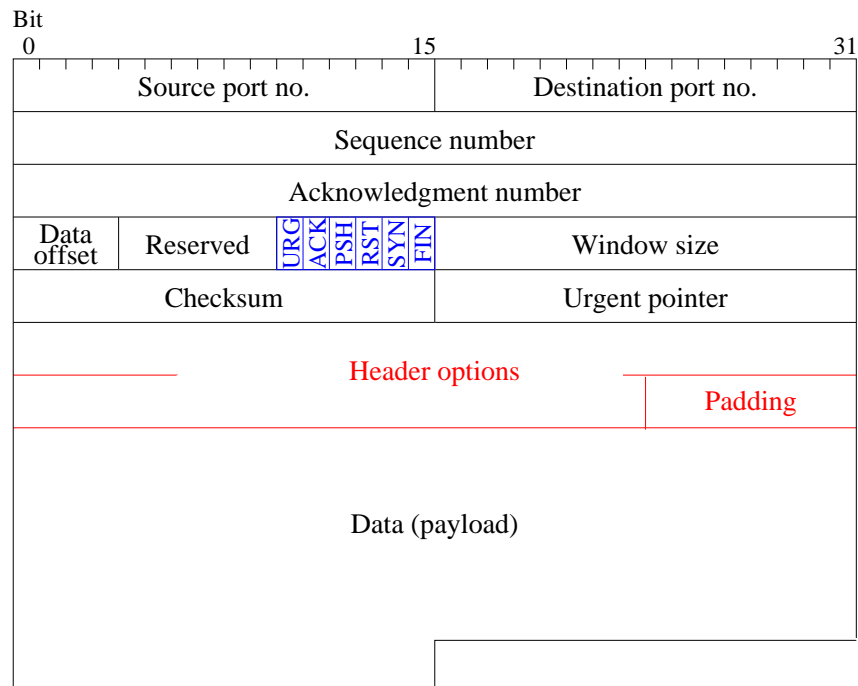

Figure 6.6: Encoding of a TCP PDU

The padding is used to make the length of the header a multiple of 32 bits.

quence numbers with the other party.

FIN: Sender has no more data to send, and wishes to close connection.

RST: Sender has detected a failure in the operation of the protocol, and aborts the connection.

URG: Indicates that the Urgent Pointer is significant, and that it gives the offset of Urgent Data in the PDU.

ACK: Indicates that the Acknowledgement field is significant.

PSH: Push Function.

For example, to set up a connection, the initiator sends a PDU with the SYN flag set and (a proposal for) an initial sequence number, say n_s . The called party replies with a PDU with the SYN and ACK flags set, and includes its own (proposal for an) initial sequence number, say n_r , and an acknowledgment with the initiator's initial sequence number, $(n_s + 1)$. Finally, the initiator responds to this with a PDU with the ACK flag set, with sequence number $(n_s + 1)$ and an acknowledgment with the responder's initial sequence number, $(n_r + 1)$. Similarly, the FIN flag is used to indicate that the sender wishes to terminate the connection. For full details of the operation of the protocol, see [18].

6.3 User Datagram Protocol, UDP

UDP is an alternative Transport layer protocol which provides a connectionless-mode service. It is described in RFC768, also known as Internet Standard 6 [16]. UDP uses the same concept of *ports* as TCP to provide multiplexing of several streams of data between systems with a given pair of IP addresses, and the same restrictions with respect to assigned ports apply. Naturally the protocol contains no features for setting up or closing connections, sequence numbering or flow control, since all these things are meaningless in a connectionless context. Each UDP PDU is sent independently of the others via the underlying IP service.

6.4 Internet Application Layer Protocols

A large number of (more or less) standardised protocols are in common use in the Application Layer of the Internet. We shall go into details with two of them later in these notes, but a summary of some of the most important ones and their associated port numbers is given in Table 6.2.

You can easily find a list of assigned port numbers and the associated applications if you have access to a system which uses a Unix-based operating system, such as Linux or Solaris: just look in the `/etc/services` file. A complete and up-to-date list is maintained

Port	Protocol	Application
20	FTP (data stream)	File transfer
21	FTP (control stream)	
23	TELNET	Virtual terminal
25	SMTP	Mail transfer
53	DNS	Domain Name Service
80	HTTP	Web service
110	POP3	Mail retrieval
119	NNTP	News service
123	NTP	Clock synchronisation
143	IMAP	Interactive mail retrieval
389	LDAP	Lightweight directory access

Table 6.2: Internet Application Layer protocols

by IANA, the authority which registers the numbers, and can be seen on the Web page <http://www.iana.org/assignments/port-numbers>.

7 Simple Mail Transfer Protocol, SMTP

The first detailed example of an Internet Application layer protocol which we shall look at is SMTP, of which a full description can be found in Internet RFC821, which forms part of Internet Standard 10 [19]. The purpose of SMTP is to transfer mail messages composed by a user for transmission to one or more other users. In fact, in the Internet world, mail is not sent directly to the recipient user (who of course might not be logged on when the message is sent), but is transferred to a *mailbox* owned by the recipient instead. At some convenient time, the recipient needs to use another protocol to retrieve his or her mail from the mailbox so that it can be read (or whatever needs to be done with it). The two commonest protocols for retrieving mail from a mailbox are:

- The so-called *Post Office Protocol*, usually just known as *POP*, of which the most recent version is version 3 (“POP3”). This is described in Internet RFC1939 [21], which is Internet Standard 53.
- The *Internet Message Access Protocol (IMAP)*, of which the current version is version 4 (“IMAP4”), described in RFC2060 [24].

The actual application is typically (but not necessarily) a so-called *mailer* – a program which looks after sending and retrieving mail for a user. The mailer therefore offers some kind of user interface, via which the user can compose messages, specify who they are to

be sent to, retrieve incoming messages and so on. The mailer uses SMTP in order actually to transfer the outgoing mail.

7.1 The Basic SMTP protocol

SMTP is a so-called *client-server* protocol: One party acts as a client, which can send requests for particular actions to be carried out by the server, which sends a response. We shall look at more systems organised in this way later in these notes. In the case of SMTP, the client is associated with the mailer from which the mail originates, and the server is a mail server associated with the mailbox into which the mail is to be deposited.

The actual protocol is in many ways a typical example of an Internet Application layer protocol. A sequence of two-way exchanges takes place between the client and server. In each exchange, the client sends a *command* identified by a four-letter code (and usually with other parameters), and the server responds with a *reply* containing a 3-digit return code indicating the success or failure of the command.

In the basic SMTP protocol, all the commands and acknowledgments are sent in the form of ASCII characters using a 7-bit encoding. The basic protocol described in RFC821 provides commands which enable the user of the protocol amongst other things to:

- Sign on as Client to initiate a mail transfer dialogue (**HELO**).
- Give the address to which replies are to be sent (**MAIL**).
- Verify a user name (**VRFY**). The server replies with the full name and mailbox address of the given user.
- Expand distribution lists (**EXPN**). The server replies with a list of user names and mailbox addresses.
- Specify a destination address for a message (**RCPT**); several **RCPT** commands may be given for the same message, if it is to be sent to several recipients.
- Send the text of a message (**DATA**); this message can only be a portion of text in ASCII code.
- Terminate the current dialogue (**QUIT**).

A slightly simplified syntax for these commands is given in Extended BNF in Table 7.1 on the following page. For a more complete presentation, see reference [19].

An simple example of a dialogue between a client on a system called `goofy.dtu.dk` and a server on system `design.fake.com` is shown in Figure 7.1. The entire dialogue is passed between client and server via a previously set up TCP connection between `goofy.dtu.dk` and `design.fake.com`, using port number 25 at each end. The significance of the exchanges in the dialogue is as follows:

```

<command> ::= "HELO" <sp> <domain> <crlf>
           | "MAIL" <sp> "FROM:" <reverse-path> <crlf>
           | "RCPT" <sp> "TO:" <forward-path> <crlf>
           | "VRFY" <sp> <string> <crlf>
           | "EXPN" <sp> <string> <crlf>
           | "DATA" <crlf>
           | "QUIT" <crlf>
<forward-path> ::= <path>
<reverse-path> ::= <path>
<path> ::= "<" <mailbox> ">"
<mailbox> ::= <local-part> "@" <domain>
<local-part> ::= <string> { "." <string> }*
<domain> ::= <element> { "." <element> }*
<element> ::= <name>
           | "#" <number>
           | "[" <dotnum> "]"
<dotnum> ::= <number> "." <number> "." <number> "." <number>
<number> ::= { <digit> }+
<name> ::= <alpha> { <anh> }* <alphanum>

<alpha> ::= upper or lower case English letters
<digit> ::= decimal digits
<alphanum> ::= <alpha> | <digit>
<anh> ::= <alpha> | <digit> | "-"

```

Table 7.1: SMTP command syntax

The syntax is given in EBNF, where [x] indicates an optional syntactic element x, {x}* a repetition of 0 or more elements and {x}+ a repetition of 1 or more elements. The full SMTP syntax given in reference [19] includes several more commands.

```
HELO goofy.dtu.dk
250 design.fake.com
MAIL FROM:<bones@goofy.dtu.dk>
250 OK
RCPT TO:<snodgrass@design.fake.com>
250 OK
DATA
354 Start mail input; end with <CRLF> . <CRLF>
From: Alfred Bones <bones@goofy.dtu.dk>
To: William Snodgrass <snodgrass@design.fake.com>
Date: 21 Aug 2000 13:31:02 +0200
Subject: Client exploder

Here are the secret plans for the client exploder
etc. etc. etc.
.
250 OK
QUIT
221 design.fake.com
```

Figure 7.1: Exchange of messages in SMTP

Commands from the client to the server are in typewriter font and replies from server to client are boxed in *italic typewriter* font.

1. The client signs on as a client to the server, giving the name of the client's system (`goofy.dtu.dk`) as parameter to the `HELO` command. The server replies with the return code 250, which means that the command is accepted, and supplies the server name (`design.fake.com`) as parameter to the response.
2. The client informs the server where replies are to be sent, supplying the appropriate mailbox name (here `bones@goofy.dtu.dk`) as parameter to the `MAIL` command. The server replies with return code 250, indicating acceptance.
3. The client informs the server about who is intended to receive the mail, supplying the appropriate mailbox name (here `snodgrass@design.fake.com`) as parameter to the `RCPT` command. The server again gives a positive response.
4. The client asks the server to prepare to receive the body of the message, by sending the `DATA` command. The server again responds positively, this time giving code 354, together with instructions about the way in which the message is to be sent.
5. The client sends the body of the message, terminating with a line containing only a period (`.`). The server responds with return code 250, indicating acceptance.
6. The client signs off (`QUIT`), and the server responds with a code 221, supplying the name of the server as parameter. (This is useful to the client, in case it has signed on to several servers...).

At this stage the dialogue is complete. Note that in this example all the responses from the server have been positive ones. This is not always the case. The complete set of reply codes is shown in Table 7.2. Codes of the form 2xy are positive responses, those of form 3xy are informative (further information is needed in order to complete the requested action), 4xy indicates a possibly transient error, meaning that it may be sensible to try the same command again slightly later, while 5xy indicates a permanent error, for example a meaningless command or serious lack of resources in the server.

7.2 MIME

The basic SMTP protocol as originally defined only made it possible to send simple messages containing characters from the ASCII character set (basically, the letters of the English alphabet, digits and English punctuation marks). However, a substantial set of *extensions* have been defined for SMTP, of which some of the most important are the group known as *Multipurpose Internet Mail Extensions (MIME)*, which enable messages to contain more complex data than simple ASCII texts, by allowing the user to encode:

1. Message bodies containing text in character sets other than US ASCII.
2. Non-text message bodies, such as images, audio and video.
3. Multi-part message bodies.
4. Message headers in character sets other than US ASCII.
5. Authenticated and encrypted message bodies.

Code	Meaning
211	System status, or system help reply
214	Help message [useful only to the human user]
220	<domain> Service ready
221	<domain> Service closing transmission channel
250	Requested action OK, completed
251	User not local; will forward to <forward-path>
354	Start mail input; end with <CRLF>.<CRLF>
421	<domain> Service not available, closing transmission channel
450	Requested action not taken: mailbox unavailable [E.g. mailbox busy]
451	Requested action aborted: local error in processing
452	Requested action not taken: insufficient system storage
500	Syntax error, command unrecognized
501	Syntax error in parameters or arguments
502	Command not implemented
503	Bad sequence of commands
504	Command parameter not implemented
550	Requested action not taken: mailbox unavailable [E.g., mailbox not found, no access]
551	User not local; please try <forward-path>
552	Requested action aborted: exceeded storage allocation
553	Requested action not taken: mailbox name not allowed [E.g., incorrect syntax]
554	Transaction failed

Table 7.2: SMTP reply codes

Clients wishing to use SMTP extensions such as MIME must start their dialogue with a command EHLO (instead of HELO) and a server which implements the extensions must recognise this new command.

MIME encoding is intended for use with substantial chunks of data, such as entire documents or images. Each such chunk is known as a *MIME entity* [22]. An entity is encoded as a *header* followed by a *body*, where the header consists of a sequence of *fields* which specify:

1. The *content type* of the body.
2. The *encoding* of the body.
3. A *reference* (for example, a serial number or identifier) which can be used to refer to the body from other entities.
4. A *textual description* of the entity.
5. Possibly some *extension fields*, describing additional or non-standard attributes of the entity.

The **content type** header field specifies a *type* and *subtype*, where the type can be *discrete* or *composite*. An entity of a discrete type contains a single block of data representing a text, image, audio stream, video stream or similar, while an entity of a composite type is composed from smaller entities, which may themselves be of discrete or composite type. A number of standardised types and subtypes are pre-defined in the MIME standards, and others can be added either informally or via a formal registration process to the IETF. The standard types defined in Part 2 of the Internet MIME standard [23] can be seen in Table 7.3.

For several of these types and subtypes, content type header fields may also include *parameters*, for example the actual character set used in a **text/plain** entity, the delimiter string in a **multipart** entity, the fragment number in a **message/partial** entity, the access type (FTP, ANON-FTP, LOCAL-FILE, . . .), expiration date, size and access rights (**read**, **read-write**) for a **message/external-body** entity, and so on.

The **encoding** header field describes the way in which the content has been encoded *in addition to* the encoding implied by the content type and subtype. An encoding which is not an identity transformation may be needed if the body of the entity contains data which for some reason cannot be passed transparently by the protocol in use. For example, basic SMTP can only be used to transfer sequences of ASCII characters in a 7-bit representation. The standard encodings are:

- 7bit** No transformation has been performed on the data, which consist entirely of lines of not more than 998 characters in a 7-bit representation, separated by a CRLF character pair.
- 8bit** No transformation has been performed on the data, which consist entirely of lines of not more than 998 characters in an 8-bit representation, separated by a CRLF character pair.

Discrete type	Subtypes	Explanation
text	plain	Plain text, viewed as a sequence of characters, possibly with embedded line breaks or page breaks.
	enriched	Text with embedded formatting commands in a standard markup language.
image	jpeg	Images encoded in accordance with the JPEG standard using JFIF encoding [15].
audio	basic	Single channel audio encoded using 8-bit ISDN mu-law at a sample rate of 8000 Hz. [3]
video	mpeg	Video encoded in accordance with the MPEG standard [14].
application	octet-stream	Arbitrary binary data.
	postscript	Instructions for a PostScript™ interpreter.
	x-...	User-defined application subtype.
Composite type	Subtypes	Explanation
message	rfc822	A complete mail message in accordance with Internet RFC822.
	partial external-body	A (numbered) fragment of a larger MIME entity. A reference to the body of a mail message which is not embedded in the current entity.
multipart	mixed	A sequence of independent body parts, each delimited by a unique sequence of characters.
	alternative	A sequence of body parts, each delimited by a unique sequence of characters, and each representing an alternative version of the same information.
	digest	A sequence of independent body parts, which by default are messages.
	parallel	A set of independent body parts, each delimited by a unique sequence of characters.

Table 7.3: Standard MIME entity types and subtypes [23]

Data	Character	Data	Character	Data	Character	Data	Character
000000	A	010000	Q	100000	g	110000	w
000001	B	010001	R	100001	h	110001	x
000010	C	010010	S	100010	i	110010	y
000011	D	010011	T	100011	j	110011	z
000100	E	010100	U	100100	k	110100	0
000101	F	010101	V	100101	l	110101	1
000110	G	010110	W	100110	m	110110	2
000111	H	010111	X	100111	n	110111	3
001000	I	011000	Y	101000	o	111000	4
001001	J	011001	Z	101001	p	111001	5
001010	K	011010	a	101010	q	111010	6
001011	L	011011	b	101011	r	111011	7
001100	M	011100	c	101100	s	111100	8
001101	N	011101	d	101101	t	111101	9
001110	O	011110	e	101110	u	111110	+
001111	P	011111	f	101111	v	111111	/

Table 7.4: Base64 encoding of 6-bit binary sequences

binary No transformation has been performed on the data, which consist of a sequence of arbitrary octets.

quoted-printable A transformation to quoted-printable form has taken place on the data, such that:

1. non-graphic characters,
2. characters which are not ASCII graphical characters,
3. the equals sign character,
4. white space (SP, TAB) characters at the end of a line

are replaced by a 3-character code "=XY", where X and Y are two hexadecimal digits which represent the code value of the character. US-ASCII graphical characters (apart from =) may optionally be represented in the same way or may appear literally. Lines longer than 76 characters are split by the insertion of ‘soft line breaks’ (represented by an equals sign followed by a CRLF character pair). Thus for example:

```
Les curieux =E9v=E9nements qui font le sujet de cette chron=
ique se sont produits en 194., =E0 Oran.
```

represents the text *Les curieux événements qui font le sujet de cette chronique se sont produits en 194., à Oran.* – the opening sentence of Albert Camus’ novel “La Peste”. Here E9 is the code value for é, E0 is the value for à, and the equals sign which ends the first line indicates a soft line break. This transformation is intended to allow text to pass through systems which are restrictive with respect to line length and character set.

base64 A transformation to base-64 coding has taken place.

Here, each 24 bit sequence of data is encoded as 4 characters from a 64-character subset of the US-ASCII set of graphical characters, where each character corresponds to 6 bits of the data, as shown in Table 7.4. For example:

101101	011110	000111	010011	001111	101011	111110	000000
t	e	H	T	P	r	+	A

Data sequences which are not multiples of 6 bits are padded on the right with 0-bits to a multiple of 6 bits before conversion to characters as above; if they are then not a multiple of 4 characters, they are further padded on the right with the character "=". The characters are broken up into lines of not more than 76 characters, the lines being separated by CRLF (which has no significance for the coding). This transformation is intended to allow binary data to pass through systems which are restrictive with respect to line length and character set.

A complete example of a mail message body, composed of a multipart entity in MIME encoding, and illustrating several of these features, is shown in Figure 7.2 on the following page. Since the body has been converted into an encoding which exclusively uses ASCII characters, it can be sent using SMTP, just like the simple message seen in Figure 7.1, though in this case the client system is evidently `bugeyed.monster` and the server `tundranet.ice`.

8 HTTP and the World Wide Web

The World Wide Web is a distributed system which offers global access to information. The basic architecture follows a Client-Server model, with a very large number of servers, on which the information is stored, offering uniform access to the clients. The unit of information generally corresponds to a file on the server, and is known as a (*Web*) *resource*.

8.1 Uniform Resource Identifiers

Uniform access is assured by the use of a unified, global naming scheme in which each resource is identified by a *Uniform Resource Identifier (URI)* which specifies a so-called *scheme* identifying the access protocol to be used, the *server* (with optional *user information* and information about the *port* to be accessed), and the *path* to the file. In addition, the URI may provide a *query* to be interpreted by the resource. A slightly simplified syntax (in Extended BNF notation) for URIs is given in Figure 8.1; a more complete description can be found in [27].

Some examples of URIs are as follows:

From: Ebenezer Snurd <ebes@bugeyed.monster>
 To: Rod Akromats <rak@tundranet.ice>
 Date: Wed, 09 Aug 2000 12:34:56 +0100 (CET)
 Subject: Finalised material
 MIME-Version: 1.0
 Content-type: multipart/mixed; boundary=5c12g7YTurb19zp4Ux

This is the MIME preamble, which is to be ignored by mail readers that understand multipart format messages.

--5c12g7YTurb19zp4Ux
 Content-type: text/plain; charset=ISO-8859-1
 Content-transfer-encoding: 8bit

Dear Rod,

Here are some recent pictures, including the mail I told you about from the Clones. Enjoy!

Ebe.

--5c12g7YTurb19zp4Ux
 Content-type: image/jpeg
 Content-transfer-encoding: base64

Ap3u107+yacdfe66menop4RorS8hach8tf3

...

--5c12g7YTurb19zp4Ux
 Content-type: message/external-body; access-type=local-file;
 name="/usr/home/ebes/pix/clo08.ps";
 site="drones.hive.co.uk"
 Content-type: application/postscript
 Content-id: <id003@woffly.speakers.com>
 --5c12g7YTurb19zp4Ux--

This is the MIME epilogue. Like the preamble, it is to be ignored.

Figure 7.2: MIME encoding of a message body with three parts

The parts are separated by a boundary marker starting with "--", followed by the boundary string "5c12g7YTurb19zp4Ux".

Header fields are shown in typewriter font and bodies in *italic typewriter* font.

```

<absoluteURI> ::= <scheme> "://" <server> <path> ["?" <query>]
<server>      ::= [<userinfo> "@"] <hostport>
<hostport>   ::= <host> [":" <port>]
<host>       ::= <hostname> | <IPv4address>
<port>       ::= { <digit> }*
<path>       ::= "/" { <segment> "/" }*
<segment>    ::= { <pchar> }*
<pchar>      ::= <alpha> | <digit> | "-" | "_" | "." | "!" |
               "~" | "*" | ">" | "(" | ")" | ":" | "@" |
               "&" | "=" | "+" | "$" | ", "

```

Figure 8.1: Syntax of Uniform Resource Identifiers.

The syntax is given in EBNF, where [x] indicates an optional syntactic element x, and {x}* a repetition of 0 or more elements.

http://www.usenix.org/membership/renew.html

Refers to the resource to be found via path `/membership/renew.html` on the server with hostname `www.usenix.org`, to be accessed using the HTTP protocol.

http://abc.com/~smith/index.html

Refers to the resource to be found via the path `~smith/index.html` on the server with hostname `abc.com`, to be accessed using the HTTP protocol.

http://abc.com:80/~smith/index.html

Refers explicitly to port 80 (the default port number for the HTTP protocol), but otherwise identical to the second example.

http://www.bahn.de/bin/query?text=Berlin&maxresults=10

Refers to the resource to be found via path `/bin/query` on the server with hostname `www.bahn.de`, to be accessed using the HTTP protocol.

The query `text=Berlin&maxresults=10` will be passed on to the resource.

ftp://ftp.isi.edu/in-notes/rfc2396.txt

Refers to the resource to be found via the path `/in-notes/rfc2396.txt` on the server with hostname `ftp.isi.edu`, to be accessed using the FTP protocol.

telnet://ratbert.comfy.com/

Refers to the resource to be found via the path `/` on the server with hostname `ratbert.comfy.com`, to be accessed using the TELNET protocol.

Hostnames are expressed using the standard Internet naming conventions, as a sequence of domain names separated by dots. Paths are typically (depending on the protocol in use and the type of resource) expressed relative to some base defined within the server. User information, `userinfo`, is typically a user identifier, possibly with security-related parameters required to gain access to the resource.

8.2 Hypertext Transfer Protocols

Hypertext is a generic term for the content of documents which potentially may involve various types of information, such as:

- **Static elements** of various types, such as text, images and sounds.
- **Dynamic elements**, which are to be created 'on the fly' by the execution of programs.
- **Embedded links** (so-called *hyperlinks*) to resources containing further information. This information may be intended to be accessed automatically when the document containing the link is accessed, or it may require some action on the part of a human user in order to activate the link.

The task of a hypertext transfer protocol is to provide a service for storing and retrieving hypertext documents. The classic example is currently the Internet/DoD *Hypertext Transfer Protocol (HTTP)*, of which the most recent version is version 1.1 [5]. This makes use of a series of two-way exchanges between a client, which is typically integrated into a Web browser application, and one or more servers, in this context usually known as Web servers. In each exchange, the client sends a *request* which identifies a *resource* by giving its URI, specifies an action (known as a *method*) to be performed on the resource, and optionally gives parameters describing the action in more detail. The server replies with a *Response* which gives a status code for execution of the action, and possibly includes further information about the resource. This information may include the content of the resource and/or other parameters.

A very simple example of such an exchange is shown in Figure 8.2. The `GET` request specifies the URI from which the resource is to be retrieved and the protocol version to be used (here version 1.1). Since this request refers to a resource on the system `www.wpooh.org`, it must be assumed that a TCP connection from the client system to `www.wpooh.org` has been (or will be) set up by the application before the exchange of HTTP messages actually takes place. It is a convention of HTTP/1.1 that the request also contains a header-line, starting with the keyword `Host:`, and explicitly specifying the host on which the resource is ultimately located. In the example in Figure 8.2, this is redundant information. However, the same effect could be obtained without redundancy by using the request:

```
GET ~/pooch/index.html HTTP/1.1
Host: www.wpooh.org
```

Each request ends with a blank line which terminates the request.

The response is a code (200 OK) indicating success, followed by header fields associated with the response and the actual content of the resource, which in the example is a document in *Hypertext Markup Language (HTML)*. The document contains an embedded link to

```
GET http://www.wpooh.org/~pooh/index.html HTTP/1.1
Host: www.wpooh.org
```

```
HTTP/1.1 200 OK
Date: Thu, 8 Aug 2002 08:12:31 EST
Content-Length: 332

<html>
<head>
  <title>Pooh's Homepage</title>
</head>
<body>
  <h1 align=center>Winnie the Pooh</h1>
  
  <p>
    Our little bear is short and fat
    Which is not to be wondered at.

    He gets what exercise he can
    By falling off the ottoman.
  </p>
</body>
</html>
```

Figure 8.2: Simple exchange of messages in HTTP

The request from the client to the server is in `typewriter` font and the reply from server to client is boxed in `typewriter` font. The actual content of the resource within the box is in *italic typewriter* font.

a further resource, in this case containing an image at URI `http://www.wpooh.org/pooh.img`. It is the client's task to fetch this further resource when required. Normally, the Web browser or other application in which the client is embedded will determine when this will take place, possibly after consulting the user. In more complex cases, documents may also contain references to programs to be executed by the client (as so-called *applets*) or the server (as so-called *(active) server pages* or *server scripts*) in order to produce parts of the content of the resource dynamically.

The standard methods available via HTTP and their functions are:

GET Retrieve content of resource.

PUT Store new content in resource.

DELETE Delete resource.

OPTIONS Request information about resource or server.

HEAD Get headers (but not actual content) of resource.

POST Transfer information to application, for example for transmission as mail, processing as a Web form, etc.

TRACE Trace route to server via loop-back connection.

Obviously, a given method can only be used for a particular resource on a given server if the user on the client has suitable authorisation from the server.

More complex forms of request allow the client to specify more closely what is required or to describe its own abilities. This is done by following the main request with further header fields, as in the conventions for using MIME. It is possible, for example, for the client to:

- Define acceptable media types (header field **Accept**), i.e. media types which the client-side system can deal with. These are described in a notation similar to that for MIME content-types. For example: `text/html`, `text/x-dvi`, `video/mpeg`, etc.
- Define acceptable character sets (header field **Accept-Charset**, specifying a list of one or more character sets).
- Define acceptable natural languages in which the document may be written (header field **Accept-Language**, specifying a list or one or more language codes).
- Define acceptable forms of compression or encoding, such as `gzip` or the use of Unix `compress` (header field **Accept-Encoding**, specifying a list of one or more encodings).
- Specify that only part of the document is to be transferred (header field **Range**, specifying a range in bytes).
- Restrict the operation to resources which obey given restrictions with respect to their date of modification (header fields **If-Modified-Since** and **If-Unmodified-Since**, specifying a date and time).
- Control caching of the document (header field **Cache-Control**, specifying rules such as the maximum time for which a cached document is valid (`max-age`), or giving directions not to store a document (`no-store`) or always to retrieve it from the original server rather than a cache (`no-cache`)).

```
GET pub/WWW/xy.html HTTP/1.1
Host: www.w3.org
Accept: text/html, text/x-dvi;q=0.8
Accept-Charset: iso-8859-1, unicode-1-1;q=0.5
Accept-Encoding: gzip, identity;q=0.5, *;q=0
Accept-Language: da, en-gb;q=0.8, en;q=0
Range: bytes=500-999
Cache-control: max-age=600
```

Figure 8.3: A more complex HTTP Get request

- Provide security information for authorisation purposes (header field `Authorization`, specifying a list of credentials).

A complete example of a more complex GET request is shown in Figure 8.3. This specifies that the content of the resource at URI `http://www.w3.org/pub/WWW/xy.html` should be retrieved from `www.w3.org` using HTTP version 1.1. The further header fields are to be understood as follows:

- The client can accept contents in HTML or DVI syntax. The `q`-parameter, here `q=0.8`, associated with the DVI media type means that the client will only give files of this type a *relative preference* of 0.8. Absence of a `q`-parameter implies `q=1.0`.
- The client will accept character sets `iso-8859-1` and `unicode-1-1`, but will only give the latter a relative preference of 0.5.
- The client will accept `gzip` compression with preference 1.0, while the `identity` transformation has preference 0.5 and all other forms of compression (denoted by `*`) should be avoided (`q=0`).
- The client will accept documents in Danish (`da`) with preference 1.0, British English (`en-gb`) with preference 0.8, and all other forms of English should be avoided (`q=0`).
- Bytes 500 to 999 (inclusive) of the document are to be retrieved.
- The document can be taken from a cache unless the cached copy has an age which exceeds 600 seconds.

The server is expected to respect the relative preference values given by the client, to the extent that this is possible. So in this example, the server should provide the Danish version of the document, if such a version is available; if not, then a British English version should be provided, if available. If neither of these are available, the server should give a negative response.

More complex *responses* than in Figure 8.2 can be used to inform the client about the content or encoding of the document, give the reasons for an error response, or provide information about the server itself. As in the case of requests, this information is provided

```
HTTP/1.1 200 OK
Date: Thu, 8 Aug 2002 08:12:31 EST
Content-Length: 332
Content-Type: text/html; charset=iso-8859-1
Content-Encoding: identity
Content-Language: en
Content-MD5: ohazEqjF+PG0c7B5xumdgQ==
Last-Modified: Mon, 29 Jul 2002 23:54:01 EST
Age: 243
```

```
<html>
...
</html>
```

Figure 8.4: A more complex response to a GET request in HTTP

The actual content of the document, which starts (in *italic type-writer* font) after the first blank line of the response, has been abbreviated in the figure.

in the form of header fields. The response shown in Figure 8.2 is in fact the minimum one, with header fields giving only the obligatory information: The *length* of the document retrieved and the *date* (and time) at which retrieval took place. Figure 8.4 shows a more complex response which could have been received after the same request, if the server had included some of the optional header fields. The **Content-Type**, **Content-Encoding** and **Content-Language** give the actual values of these parameters and should be expected to correspond to the acceptable values, if any, specified in the request. The **Content-MD5** field gives a base64 encoded checksum for the content evaluated using the MD5 *message digest* algorithm. The **Age** field is included if the content has been taken from a cache, and gives the length of time in seconds that the content has been stored in the cache. The **Last-Modified** field gives the date and time at which – to the server’s best knowledge – the content of the resource was last modified. Such complex responses are particularly useful when the request is **OPTIONS**, where the purpose is to obtain information about the capabilities of the server, such as which content types or encodings it is able to handle.

9 Network Programming with Sockets

To program a client or server as part of an application, we need to have access to programming language facilities which enable us to set up a communication channel between the

Primitive	Semantics
socket	Create new communication endpoint
bind	Associate local address (IP address + port number) with socket
listen	Announce willingness to accept connections
accept	Block caller until a connection request arrives
connect	Initiate establishment of a connection
write/send	Send data over connection
read/recv	Receive data over connection
close	Release connection

Table 9.1: Berkeley TCP/IP stream sockets interface primitives

client and server processes in their respective systems. The usual abstraction for this purpose is known as a *socket*. A socket is, strictly speaking, the endpoint of a channel between two processes, and is identified by the relevant IP address and port number. The socket abstraction was originally developed for use in BSD Unix, but is now generally available on many platforms. Table 9.1 summarises the set of primitives offered in the Berkeley (BSD) TCP/IP stream sockets interface.

In these notes, we shall consider sockets as they are implemented in Java. This implementation is independent of the underlying operating system, and is therefore a good starting point for getting to grips with the main ideas involved. Sockets for use in most other languages, such as C and C++, are usually provided via libraries associated with particular versions of particular operating systems, and are therefore much less portable and more subject to change. In fact, even the Java socket abstraction has changed somewhat over time; the discussion in these notes is based on the Java 2 SDK Standard Edition version 1.4.0 platform, and the examples have all been run using JDE version 1.4.1.

9.1 Java Client Sockets

Java sockets for use in clients are objects of the class `Socket`, which is part of the `java.net` package. You should consult the documentation of this package in order to find the full details of what is available. If you are already familiar with BSD socket primitives, you will notice that the Java `Socket` class implements the BSD `socket` primitive via the class constructor, and the BSD `bind`, `close` and `connect` primitives as methods. The `listen` and `accept` primitives are not relevant for clients, and the input/output primitives are all implemented as methods of one of the Stream objects associated with the socket. We return to a discussion of these Stream objects below. Note that the `Socket` class makes use of *TCP* connections to the server; to use a communication channel based on *UDP*, an object of the `DatagramSocket` class is used instead.

```

int    portno    = p;
string servname = s;
try
{ Socket serv = new Socket(servname, portno);
  System.out.println("Connected to server " + serv.getInetAddress());
  InputStream  si = serv.getInputStream();
  OutputStream so = serv.getOutputStream();

  ... communicate with server via streams si and so

  serv.close();
}
catch(IOException e)
{ System.out.println("Error in Connecting to Port "
                    + Integer.toString(portno,10)
                    + " on " + servname); }
catch(UnknownHostException e)
{ System.out.println("Cannot find server " + servname);};

```

Figure 9.1: Skeleton Java code for a simple client

To set up a client socket for a communication channel to port number p on the server with name s , the client only needs to create a suitable `Socket` object with p and s as parameters. This results in an attempt to set up a TCP connection to port p on the server. If this succeeds, methods of the `Socket` class can be used to create input and output streams for receiving from and sending to the server. If it fails, an **UnknownHostException** exception (indicating that the host name is unknown) or an **IOException** exception (indicating that some other type of error has occurred) will be thrown; these can be caught and dealt with in the usual way. In a very simple case, the code for dealing with all this could be as shown in Figure 9.1.

In practice, this is not usually a very convenient way to write code for a client, as the streams set up by using the `getInputStream` and `getOutputStream` methods of the `Socket` class are *unbuffered byte streams*. This implies that:

1. Output has to be converted by the client into byte arrays for transmission, and input has to be converted from a byte array into a value of an appropriate data type. For example, input on stream `si` can be dealt with as follows:

```

byte    b[] = new byte[256];
int     n    = si.read(b);
String  dd  = new String( b );

```

in order to produce a string `dd` from the sequence of bytes arriving on stream `si`.

Class	Description
<code>BufferedOutputStream</code>	Provides buffering (default: 512 bytes) Buffer is emptied when full or if method <code>flush()</code> is called.
<code>BufferedInputStream</code>	Provides buffering (default: 512 bytes)
<code>DataOutputStream</code> <code>DataInputStream</code>	Provides conversion of values of standard data types to sequences of bytes. Methods <code>writeInt</code> , <code>writeChar</code> , <code>writeUTF</code> etc. implement conversion for values of individual data types. Provides conversion of sequences of bytes to values of standard data types. Methods <code>readInt</code> , <code>readChar</code> , <code>readUTF</code> etc. implement conversion for values of individual data types.
<code>PrintStream</code>	Provides conversion of lines of output to sequences of bytes. Method <code>println(s)</code> converts a line of output consisting of the string <code>s</code> terminated by a newline.
<code>InputStreamReader</code>	Provides conversion of streams of bytes into streams of characters. Method <code>read</code> can be used to read single characters.
<code>BufferedReader</code>	Provides buffering for streams of characters. Method <code>read</code> can be used to read single characters or character arrays.

Table 9.2: Stream filter and converter classes

2. Input and output are not buffered, so a call to the underlying system will occur for each byte read or written. This is in many cases extremely inefficient.

To avoid these problems, the incoming stream can be passed through one or more *stream filters* which convert it into a form which can be read directly as a sequence of elements of more convenient types, such as integers, Booleans and strings. Stream filter classes are all subclasses of the `FilterInputStream` class (for input) or `FilterOutputStream` class (for output), and can thus be composed in any desired combinations. A number of useful stream filter and other stream conversion classes are shown in Table 9.2.

An example of a sequence of filters used for input and output is given in Figure 9.2. The circles represent transformations performed on the streams as they pass on their way to or from the socket. A further example, more in accordance with typical use in Java 2, follows in the code of Figure 9.3 on page 59

A more complete example of code for a client is shown in Figures 9.3 on page 59 and 9.4 on page 60. This combines the ideas presented above to communicate with an SMTP server, in fact to produce the dialogue shown in Figure 7.1 on page 41. Of course, you may complain that this is not a very useful client – after all, who wants a mail client which always sends the same message to the same destination? You might also like to make sure

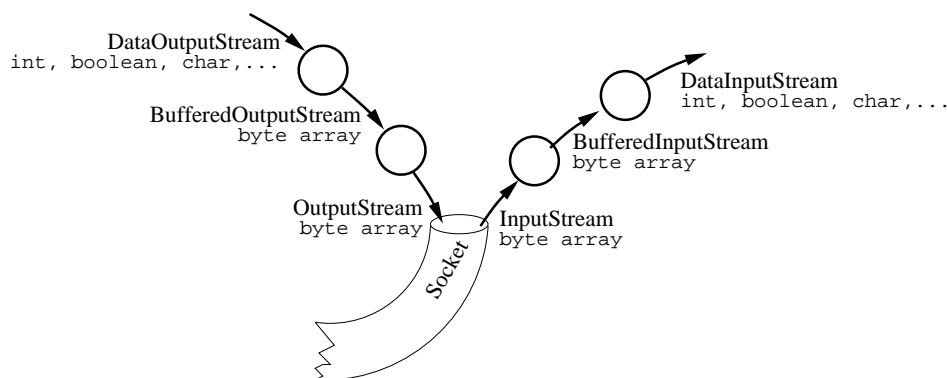

Figure 9.2: A sequence of stream filters applied to input and output

that the names and dates given in the body of the message correspond to those used in the rest of the dialogue with the server, so that the client cannot send spoof messages, just like sources of junk mail often do. Extending this code for use in a mailer which can send arbitrary messages correctly to arbitrary destinations is left as an exercise for the reader.

9.2 Java Server Sockets

In contrast to the BSD socket API, where there is no basic difference between client and server sockets, Java sockets for use in servers are objects of the class `ServerSocket`, which like `Socket` is part of the `java.net` package. This class contains methods such as `accept`, `bind` and `close` which are appropriate for use on the server side of a client-server system. Like the `Server` class, the `ServerSocket` does not itself contain methods for input or output, which must take place via input and output streams.

To set up a server socket for port number p on server s , the server creates a suitable `ServerSocket` object and applies the `accept` method to it in order to listen for an incoming call from a client. This blocks the progress of the server until a client sets up a TCP connection to port p on the server. When the connection is set up, the method returns a reference to the `Socket` associated with the client. Input and output can then take place via the input and output streams associated with the *client's* socket. In a very simple case, the code for this could be as shown in Figure 9.5 on page 61, which should be compared with the code for the simple client given in Figure 9.1. Note that the `accept` method will throw a `SocketTimeoutException` exception if the server waits longer than a timeout value, say t milliseconds, previously defined by calling the `ServerSocket`'s `setSoTimeout` method with a parameter of value t . This is used to improve the performance of the server, so that it does not just “hang” if no clients are active.

The example given here is very simple, and for practical use would need to be extended in several ways. Firstly, the code would usually be modified to use appropriate stream filters

```

import java.net.*;
import java.io.*;

public class SMTPclient
{ public static void main(String[] argc)
  { String      servname = "design.fake.com";
    int         portno   = 25;
    String      recip    = "snodgrass";
    String      cliname  = "goofy.dtu.dk";
    String      sender   = "bones";

    Socket      s1;
    PrintStream p1;
    BufferedReader d1;
    String      recvreply;

    try
    { s1=new Socket(servname,portno);
      System.out.println("Connected to server " + servname
                        + " at " + new Date());
      System.out.println("-----");
      // Set up input and output streams
      d1=new BufferedReader(
        new InputStreamReader(
          new BufferedInputStream(
            s1.getInputStream(),2500)));
      p1=new PrintStream(
        new BufferedOutputStream(
          s1.getOutputStream(),2500),true);
      recvreply = d1.readLine();
      System.out.println("Server Response: "+recvreply);

      ... Here we insert the code for the dialogue
           with the server.  See Figure 9.4

      s1.close();
      System.out.println("Closed connection to server"
                        + " at " + new Date());
    }
    catch(IOException e)
    { System.out.println("Error in Connecting to Port "
                        + Integer.toString(portno,10)
                        + " on " + servname); }
    catch(UnknownHostException e)
    { System.out.println("Cannot find server " + servname); };
  }
}

```

Figure 9.3: Skeleton Java Code for an SMTP client

```
// Start dialogue with server
p1.println("HELO " + cliname);
recvreply = d1.readLine();
System.out.println(recvreply);

p1.println("MAIL FROM: <" + sender + "@" + cliname + ">");
recvreply = d1.readLine();
System.out.println(recvreply);

p1.println("RCPT TO: <" + recip + "@" + servname + ">");
recvreply = d1.readLine();
System.out.println(recvreply);

p1.println("DATA");
recvreply = d1.readLine();
System.out.println(recvreply);
// Send body of message
p1.println("From: Alfred Bones <bones@goofy.dtu.dk>");
p1.println("To: W. Snodgrass <snodgrass@design.fake.com>");
p1.println("Date: 21 Aug 2000 13:31:02 +0200");
p1.println("Subject: Client exploder");
p1.println("\r\n");
p1.println("Here are the secret plans...");
p1.println(" etc. etc. etc.");
p1.println(".");

p1.println("QUIT");
recvreply = d1.readLine();
System.out.println(recvreply);
```

Figure 9.4: Code to produce the client/server dialogue from Figure 7.1

```

int portno = p;
int timeout = t;
try
{
  ServerSocket serv = new ServerSocket( portno );
  serv.setSoTimeout( timeout );
  Socket client = serv.accept();
  System.out.println("Connected to client " + client.getInetAddress());
  InputStream si = client.getInputStream();
  OutputStream so = client.getOutputStream();

|                                                   |
|---------------------------------------------------|
| ... communicate with client via streams si and so |
|---------------------------------------------------|



  client.close();
}
catch (SocketTimeoutException e)
{
  System.out.println("Server socket timeout on port "
    + Integer.toString(portno,10)); }
catch (IOException e)
{
  System.out.println("Cannot set up server on port "
    + Integer.toString(portno,10)); }

```

Figure 9.5: Skeleton Java code for setting up a simple server

on the input and output streams, as in the case of the SMTP client shown in Figure 9.3. Secondly, we note that the server only has a single thread of control, so only one client can be dealt with for each activation of the server. This is hardly appropriate for use in a real system. As a minimum, the code shown here would be placed in a loop, so that several clients could be dealt with sequentially. More typically, the server would be organised to start a new *thread* for dealing with each new client which calls up, and to kill the thread when the dialogue with the client terminates. Or, for increased efficiency, the server could set up a *pool* of threads in a wait state, releasing one of them when a new client calls up and returning the thread to the waiting pool when the client terminates. Extending the code of Figure 9.5 to use threads is left as an exercise for the reader.

10 Remote Procedures and Objects

Simple network socket programming, where two parties interact by directly exchanging messages over a logical channel between them, is the most basic paradigm for distributed programming. However, if we pursue the idea that a server's purpose is to offer some kind of services to its clients, then we would often prefer to hide the details of the exchange of messages, and offer the programmer a programming model which allows the client to

perform some action on the remote server. In this section we shall look at two such models:

Remote Procedure Call (RPC), where the client is able to call a procedure which is executed on the server, possibly returning results to the client.

Remote Object Invocation (ROI), where the client is able to activate a method on a server, which is regarded as an object.

10.1 Remote Procedure Call

An essential element in distributed systems based on the Client-Server paradigm is the *Remote Procedure Call (RPC)* abstraction. This offers an interface which appears to be identical with an ordinary procedure call, but where the called procedure may be in another process in the same machine or on a remote system. RPC was originally defined by Birrell and Nelson [1] as “*the synchronous language-level transfer of control between programs in disjoint address spaces, whose primary communication medium is a narrow channel*”, a definition which stresses three important properties of RPC:

1. The participants are in different address spaces.
2. There is a (logical) channel which permits transfer of data between the participants.
3. Transfer of data is associated with transfer of control, as in activation of ordinary procedures in classical programming languages.

Subsequent work on RPC mechanisms has occasionally deviated from the definition on other points, for example by providing *asynchronous* (non-blocking) rather than *synchronous* (blocking) transfer of control, while the narrowness of the channel depends on the technology used, and can obviously be debated.

The semantics of actually executing the procedure may in fact deviate from what would be expected with a traditional procedure call, since after a failure in a remote machine it may be impossible to tell whether a message requesting execution of a procedure has been received and acted upon. Repeating the message may cause the procedure to be executed more than once; on the other hand, failing to repeat the message may result in the procedure not being executed at all. It has become conventional to refer to RPC mechanisms as having different *call semantics*, depending on what is guaranteed, as follows:

Exactly-once: The system guarantees that the procedure will return a result after being executed once, just as in a traditional local procedure call.

At-most-once: The system guarantees that the procedure will return a result after being executed not more than once.

At-least-once: The system guarantees that the procedure will return a result after being executed one or more times.

Maybe: The system makes no guarantees about execution of the procedure or the return of results after a failure.

Exactly-once semantics is unfortunately extremely costly, if not impossible, to achieve in a distributed system; this may make it difficult to ensure that local and remote RPC work in the same way. On the other hand, with at-most-once or maybe semantics there is a risk that the procedure will not be executed at all, while a system with at-least-once semantics will possibly execute the procedure several times. This can be tolerated if the procedure is *idempotent*, i.e. leads to the same result regardless of how many times execution is repeated, whereas it is a problem if the procedure has side effects.

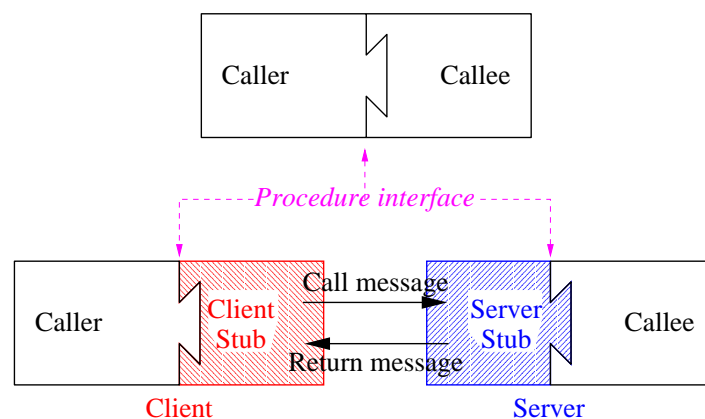

Figure 10.1: Procedure call (above) and Remote Procedure Call (below)

The standard view of a system which uses RPC is shown in Figure 10.1. Both the calling process (the *caller*) and the called procedure (the *callee*) see an interface just as if it were a local procedure being activated. To make this possible when the caller and callee reside in different address spaces, each is extended with a *stub*, which passes the parameters and results to the underlying communication system for transfer between the processes. The caller and its associated stub make up the *client* and the callee and its stub make up the *server*⁷.

Stubs perform an activity known as *marshalling* to get parameters and results into a form suitable for transfer as a message via the communication system. This involves transforming data values to an appropriate transfer representation, including the linearisation of complex data structures and (as far as possible) the substitution of pointers by actual values. Correspondingly, the stub at the receiving end *unmarshals* the contents of incoming messages and passes the parameters or results on across the procedure interface. Usually, a stub procedure is available for each procedure in the interface which can be called, and on the server side a *dispatcher* will parse the incoming messages and select the appropriate

⁷In some RPC-based systems, servers are known as *objects*, to underline the similarity between client-server systems and the caller/object structure characteristic of object oriented systems.

stub procedure. If the server is required to be able to deal with requests from several clients at the same time, as is often the case, then the dispatcher will also be responsible for creating a thread (or reusing an existing thread) in which the called procedure can be executed.

RPC stubs are nowadays compiled from descriptions of the interfaces for the procedures to be called, written in an *Interface Definition Language (IDL)*. These descriptions typically have the form of procedure headers or function prototypes, usually tagged with additional information about whether the parameters are to be passed to, from or both to and from the procedure. Two well-known IDLs for use in RPC systems are the *Sun RPC IDL*, based on Sun XDR, which was originally designed for use in systems using the *Network File System (NFS)*, and the ANSA IDL, used in the ANSA RPC toolkit. Since in these notes we shall try to confine our attention to Java-based systems, which generally use the RMI mechanism to be described in Section 10.3 below, we shall not give details of these IDLs here. However, we return to this topic in discussing CORBA later in these notes.

From the IDL description, the stub compiler generates stub code in some convenient implementation language, which will marshal and unmarshal arguments and results of the appropriate types in an efficient manner. If a type cannot be dealt with automatically by the compiler, for example because it exploits pointers in some way which the compiler cannot analyse, the user may have to supply a suitable portion of code.

10.2 Binding

In a system which supports remote operations via RPC or ROI, clients must be able to find servers offering the interfaces in which they are interested. The client may be provided with the name of the server as an item of ‘common knowledge’, or may find an appropriate server via a *registry* or *trader*, which maintains a database of available interfaces and the servers which provide them. Typical registries, such as the one for RMI discussed in the next section, offer at least the four operations:

bind: Registers a service interface and associates it with a network name or URI.

rebind: Associates a new service interface with an already registered network name or URI.

unbind: Removes information about a service interface with a given network name or URI.

lookup: Obtains a reference to a service interface with a given network name or URI.

bind, **rebind** and **unbind** are used by the server to register its services, while **lookup** is used by the client to find a desired service.

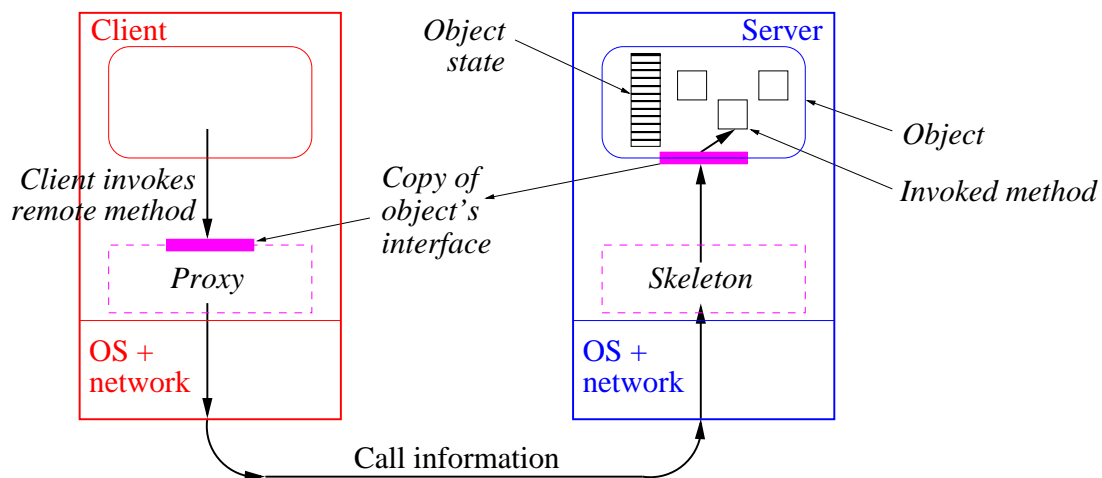

Figure 10.2: Architecture of a system with Remote Object Invocation

In many practical RPC systems, the lookup function will also deal with importing the necessary stub code, identifying the client to the server and so on. Sometimes this activity is (rather confusingly) denoted *client binding*, as it sets up a relationship between the client and the server. This is especially important in secure systems, where the server needs to have convincing information about the identity of the client, before it will allow actual RPC calls to be executed. The identity may be supplied in various ways, for example (with increasing security):

- As a *process identifier*.
- As a previously agreed (*identifier,password*) pair.
- As a *digital signature*.

In a secure system, the server will check the identity of the client during client binding, and may also require identity information to be supplied together with each call of a remote procedure.

10.3 Remote Object Invocation

Remote Object Invocation (ROI) systems are more complex than plain RPC systems because of the need to pass references to *remote objects* through a distributed system. The object itself, including all its state, continues to reside on the server side of the system. On the client side, a so-called (*object*) *proxy* is imported from the server. This is illustrated in Figure 10.2. The proxy is the object-oriented version of the *client-side stub* used in simple RPC systems, and – like the stub – it offers the same interface to the client as the remote object would. The server-side stub is in ROI systems often known as the *skeleton*. As in the case of RPC, it may not be possible to find a suitable marshalling algorithm for *all*

types of object; the type must be *serializable*. Typically, the proxy is set up when (*client*) *binding* takes place, and contains code for marshalling, unmarshalling, handling security and so on. This code is imported from the server, and many ROI systems simply represent remote object references by network references, which specify the server name or address and a path to the file on the server containing the proxy code. For example, the *URIs* used in HTTP and other systems (as discussed in Section 8 on page 47) are suitable for this purpose.

As an example of an ROI system we shall consider *Java Remote Method Invocation (RMI)*. To illustrate the idea, let us consider the very simple Java program *Blipper* shown in Figure 10.3. This program performs a (rather trivial) task, involving the use of methods `start`, `stop` and `add`, in order to manipulate a counter in an object of the class `Bliptarget`. The `start(n)` method initialises and activates the counter, the `add(i)` method increments the counter by `i` if it is active and returns its new value, and the `stop` method deactivates the counter.

This could be implemented using RMI by making the `Bliptarget` objects *remote objects*. In Java, this requires the definition of a *remote interface* which is a subclass of the `java.rmi.Remote` interface, and which defines the methods which can be accessed remotely. The code for doing this is shown in Figure 10.4 on page 68. All the methods must be declared in the interface definition as raising the `java.rmi.RemoteException` exception. The reason for this is that in a distributed system, such as one based on RMI, the network or the remote system can fail during a remote call of a method. The `RemoteException` exception indicates that some such failure has taken place. The remote interface definition is compiled in the usual way: for example, if it lies in the file `RemoteTarget.java`, the Unix command

```
javac RemoteTarget.java
```

will compile the definition into the file `RemoteTarget.class`.

The remote object must implement this interface and also inherit from the class `RemoteObject` of package `java.rmi.server` (or one of its subclasses). Typically, in simple cases, the subclass `UnicastRemoteObject` is used; this enables the remote object to be contacted by point-to-point communication via sockets. Suitable code for this implementation in our example is shown in Figure 10.5 on page 69. Since the interface requires that objects which implement it throw the `RemoteException` exception, the constructor for the remote object must also declare its ability to throw this exception. However, this does not mean that the code explicitly has to throw such an exception – it will be generated behind the scenes if a communication error occurs. Note also that the constructor uses the method `super` without parameters to activate the default constructor for objects of the parent `UnicastRemoteObject` class, which will communicate via an unspecified port. You should consult the class documentation for further possibilities.

```

import java.io.*;
import java.util.*;

public class Blipper
{ public void blip(Bliptarget b, int i)
  { int nblip = b.add(i);
    System.out.println(new Date() + ": " + Integer.toString(nblip,10)
                      + " blips");
  }

  public static void main(String args[])
  { Bliptarget t = new Bliptarget();
    Blipper    b = new Blipper();
    t.start(20);
    b.blip(t,1);
    b.blip(t,4);
    t.stop();
  }
}

=====Target=====
import java.io.*;
import java.util.*;

public class Bliptarget
{ static int bcount;
  static boolean active;

  public void start(int n)
  { System.out.println(new Date() + ": Target activated.");
    bcount = n;
    active = true;
  }

  public int add(int i)
  { if( active ) bcount = bcount + i;
    return bcount;
  }

  public void stop()
  { System.out.println(new Date() + ": Target deactivated.");
    active = false;
  }
}

```

Figure 10.3: The *Blipper* program in a non-distributed version

```

import java.rmi.*;
import java.rmi.server.*;

public interface RemoteTarget extends Remote
{ public void start(int n) throws java.rmi.RemoteException;

    public int  add(int i)   throws java.rmi.RemoteException;

    public void stop()      throws java.rmi.RemoteException;
}

```

Figure 10.4: Declaration of the remote interface for the Blipper

In the main method of the implementation, the remote object is constructed and registered in the RMI *registry*, so that its methods can be activated by clients. Registration takes place by use of the `bind` or `rebind` methods of the class `java.rmi.Naming`, which correspond to the classic methods described above in Section 10.2. In the case of RMI, `(re)bind` associates a reference to a remote object with a network reference given as an URI, and therefore in principle specifying an access protocol (typically, but not necessarily, `rmi`), a host name, a port number, and a path to the object, according to the syntax:

```
URI ::= [<scheme> "://" ] [<host> [":" <port>]] <path>
```

As can be seen, most parts of the URI are optional. If the scheme is omitted, `rmi` is used, if the host name is omitted, the name of the host on which the object is executed is used, while if the portname is omitted, port 1099 is used. The path is taken relative to the directory specified by the `CLASSPATH` property in the shell from which the compiler is run. The implementation is compiled in the usual way; for example, if it lies in the file `Target.java`, it will be compiled into the class file `Target.class`. This should be stored in a directory accessible via the `CLASSPATH`, if any.

The client for such a remote object could then, for example, be as shown in Figure 10.6 on page 70. There are several features to take note of in connection with this program, which you should compare with Figure 10.3:

1. A reference to the server is found by using the method `lookup` of the class `java.rmi.Naming`, giving a suitable URI as argument to the method.
2. References to the remote object refer to the implemented interface `RemoteTarget`.
3. It is necessary to deal with issues of security. This requirement has been strengthened in Java 2, to avoid several potential risks associated with remote operations. In particular, it is usually necessary to set up a suitable *security manager* to check that the requested remote operations are permitted. In the example, this is the default RMI

```

import java.io.*;
import java.util.*;
import java.rmi.*;
import java.rmi.server.*;

public class Target extends UnicastRemoteObject
    implements RemoteTarget
{
    static int bcount;
    static boolean active;

    public Target() throws RemoteException
    { super();
    }

    public void start(int n)
    { System.out.println(new Date() + ": Target activated.");
      bcount = n;
      active = true;
    }

    public int add(int i)
    { if( active ) bcount = bcount + i;
      return bcount;
    }

    public void stop()
    { System.out.println(new Date() + ": Target deactivated.");
      active = false;
    }

    public static void main(String args[])
    { try
      { Target t = new Target();
        String url = "rmi://localhost/Target";
        Naming.rebind(url, t);
        System.out.println( "Bound server at " + url + " to registry" );
      }
      catch(Exception e){ e.printStackTrace(); }
    }
}

```

Figure 10.5: Implementation of the remote object for the Blipper

```
import java.io.*;
import java.util.*;
import java.rmi.*;

public class Blipper
{ public Target t;

  public void blip(RemoteTarget b, int i)
  { try
    { int nblip = b.add(i);
      System.out.println(new Date() + ": " + Integer.toString(nblip,10)
                          + " blips");
    }
    catch (RemoteException e) { System.out.println("blip: " + e); }
  }

  public static void main(String args[])
  { Blipper b = new Blipper();
    String server = "localhost";
    try
    { if (System.getSecurityManager() == null)
      { System.setSecurityManager(new RMISecurityManager());
      };
      if (args.length != 0) server = args[0];
      String url = "rmi://" + server + "/Target";
      RemoteTarget rTarget =
        (RemoteTarget) Naming.lookup( url );
      rTarget.start(20);
      b.blip(rTarget, 1);
      b.blip(rTarget, 4);
      rTarget.stop();
    }
    catch (SecurityException e)
    { System.out.println("Blipper: Security exception.");
      e.printStackTrace(); }
    catch (Exception e)
    { System.out.println("Blipper: Other exception.");
      e.printStackTrace(); }
  }
}
```

Figure 10.6: Implementation of an RMI client for the Blipper

security manager, created as an object of the class `java.rmi.RMISecurityManager`, and selected for use via a call of the method `System.setSecurityManager`. Since a variety of security exceptions may also occur, the implementation shown here also specifically attempts to catch them.

This implementation is also compiled in the usual way; for example if the code is in `Blipper.java`, the compiled code will appear in the class file `Blipper.class`, which must be stored in a directory accessible via the `CLASSPATH`, if any.

To get the entire system to work together, four important steps now have to be performed:

1. The code for the *client and server stubs* has to be created. This is done in RMI by using the `rmic stub compiler`, and specifying the class name of the remote object implementation. In our simple example, where the class is not defined as part of a package, this can be done by using the Unix command:

```
rmic Target
```

If the implementation is part of a package, the fully qualified package name of the class needs to be supplied. The `rmic` compiler produces two files, in the example here `Target_Stub.class` and `Target_Skel.class`, containing code for the client-side (proxy) stub and the server-side (skeleton) stub respectively. As indicated in Figure 10.2, these stubs implement exactly the same remote interface as the remote object itself. The class files should be stored in a directory accessible via the `CLASSPATH`, if any.

2. The *RMI registry* has to be started. This is actually a simple server-side name server, typically activated by using the Unix command:

```
rmiregistry &
```

As previously stated, communication to the registry goes by default via port 1099.

3. The *remote object* has to be activated. This can be done in our simple example by using the Unix command:

```
java Target &
```

Again, if the remote object class is part of a package, the full package name of the class needs to be given. It may also be necessary to give a value for:

- The `java.rmi.server.codebase` property, giving an URI which specifies the access scheme and path to the class files on the system hosting the remote object (the server). You can omit this information if the class files are in the current directory on the local host.
- The `java.security.policy` property, giving the path to the file containing security rules which regulate what Java programs are allowed to do. As a minimum, you will need the policy file to contain rules which allow both client and server to access the registry (which by default uses port 1099) and to contact one another, which they typically do via a port with a *dynamically allocatable* number (49152 or larger).

```
grant {
    // Allow socket operations on free ports
    permission java.net.SocketPermission "localhost:1024-",
        "connect, accept, resolve";
    permission java.net.SocketPermission "goofy.dtu.dk:1024-",
        "connect, accept, resolve";
};
```

Figure 10.7: A security policy file for simple RMI applications

To test out the RMI system, you will find it easiest to run both client and remote object on the local host on which you are doing the development. In this case you just need to keep a file called `.java.policy` in your home directory, with a content in the style of that shown in Figure 10.7. This policy file allows the client and server to send to and receive from sockets with port numbers from 1024 and up on the local host, here with the Internet name `goofy.dtu.dk`. Of course you will need to replace this by the Internet name of your actual local host.

4. One or more *clients* have to be activated. This can be done in our simple example by using the Unix command:

```
java Blipper
```

This client will access a “remote” object on the local host. If an IP address is supplied after the name of the client class, then the an object on the host with this specific IP address will be accessed. If all goes well, you are now in business!

This may all seem very complex – with many steps which have to be carried out in the right order. The advantage offered by RMI and other ROI systems in return for all this is that there is no need for the code to deal explicitly with communication between the client and the remote object whose methods are to be called. The way in which this is done has been abstracted into the stubs which, “convert” calls of the methods of the remote interface into appropriate exchanges of messages. The programmer has no need to know about what happens in detail.

The instructions above are adequate only in simple cases, and you will almost certainly need to read more about RMI in order to solve anything but the simplest problems. Sun Microsystems have produced a useful tutorial introduction and a FAQ, which you can find on the Web at:

```
http://java.sun.com/j2se/1.4/docs/guide/rmi/getstart.doc.html
http://java.sun.com/j2se/1.4/docs/guide/rmi/faq.html
```

The tutorial also illustrates how to use RMI in a Windows environment. Further details about security issues are dealt with at:

<http://java.sun.com/j2se/1.4/docs/guide/security/PolicyFiles.html>
<http://java.sun.com/j2se/1.4/docs/guide/security/permissions.html>

Finally, you should note that the instructions above apply to a remote object which (once started) runs continuously. Remote objects which are activated when a client request occurs are dealt with in:

<http://java.sun.com/j2se/1.4/docs/guide/rmi/activation.html>

11 CORBA

RPC and ROI/RMI introduce a level of abstraction into the software which enables the programmer to forget about the details of marshalling, the protocol used to exchange data between client and server, and other features which were very prominent in the simple network programming approach. In this section we shall look at a further approach to programming network applications which introduces even more abstraction into the software, by offering a software environment which can operate with software components irrespective of their *implementation language*.

CORBA is a software architecture and environment for developing and implementing distributed applications, which has been developed by a consortium known as the *Object Management Group (OMG)*, and is now widely accepted as an industry standard. The current version of CORBA is version 2.3.1 [31]. The acronym CORBA stands for *Common Object Request Broker Architecture*, where the Object Request Broker (*ORB* for short) refers to a “software bus” which can be used to connect many different kinds of *software component* in a software system. The same approach to software system design, sometimes known as *component-based programming*, lies behind Microsoft’s proprietary *DCOM* architecture. The CORBA documentation explains how these two systems can interwork.

11.1 The Object Request Broker

The ORB is defined via a specification of its interface, and can be implemented in any way the ORB implementer likes, as long as the interface follows the standard. In practice, the ORBs which are available from different sources differ substantially in their internal architecture; sometimes this even gives rise to differences which can be noticed at the application level, for example in the area of thread management. These notes are based on the Sun Java ORB, but follow a set of conventions designed to make the implementations *portable* to different ORBs. For more details of how to produce portable implementations, you should consult the documentation for the Java `org.omg.CORBA.portable` package.

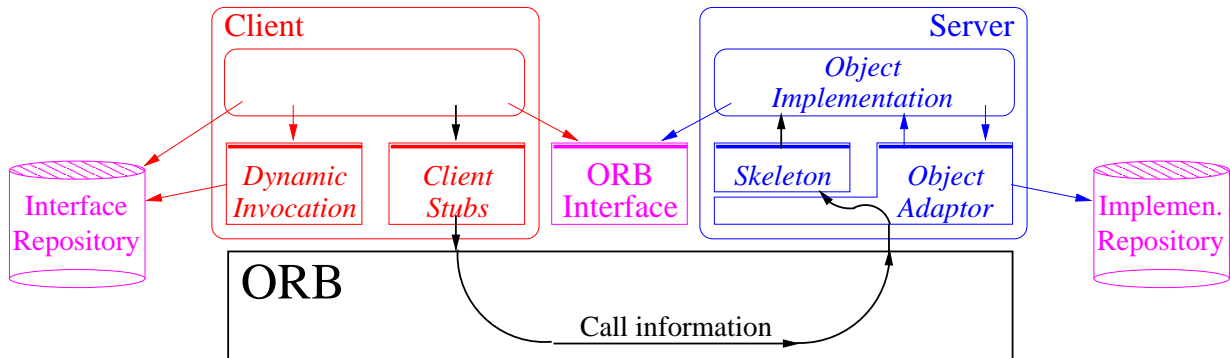

Figure 11.1: Architecture of a system based on CORBA

Figure 11.1 shows the internal structure of a system based on an ORB according to the CORBA standards, and the way in which call information passes from the caller to the called method. Features such as the stubs and skeleton should be familiar after our discussion of RMI, and have similar functions in the CORBA architecture. But in relation to Figure 10.2, you will notice that several new items have appeared:

- An *Interface Repository*, which contains information about all registered interfaces and the methods which they make available. The client can access this repository via a standard programming interface. This makes it possible for clients to invoke objects whose interface was not known when the client was compiled.
- An *Implementation Repository*, which provides a name service for objects, making it possible to register, locate and activate object implementations. The implementation repository will also typically be used in connection with installation of implementations, for controlling policies related to their activation and execution, and for storing information about the implementations, such as their resource requirements, security requirements and debugging information.
- An *Object Adaptor* on the server side, which acts as an interface to the ORB. This starts and instantiates the object implementations when required, manages the assignment of unique references to new object instances and passes calls up to the implementations. In principle, an ORB implementation can offer several object adaptors, but in CORBA version 2.3 there is a preferred object adaptor for standard use known as the *Portable Object Adaptor (POA)*, which is designed specifically for use with multiple ORB implementations. We shall discuss the POA in more detail below.
- A *Dynamic Invocation Interface (DII)*, which (in contrast to a stub) allows the client to activate a method in an object whose interface was *not* known at compile time.

Finally, both the client and the server have direct access to the ORB via an ORB interface, used primarily for starting and initialising the ORB.

An important feature of CORBA which is not explicitly shown in Figure 11.1 is that a

```
module BlipTarget
{ interface Blip
  { void start(in long n);
    long add (in long i);
    void stop ();
    oneway void shutdown();
  };
};
```

Figure 11.2: Interface definition for Blipper server in CORBA IDL

variety of services which are useful to many applications have been defined as part of the project of developing the CORBA framework. These are generally known as *Common Object Services (COS)*, and include such services as:

Naming Service: for registration of bindings between names and object references.

Event Service: for dealing with asynchronous events in CORBA-based systems, allowing components on the ORB to register and de-register their interest in receiving particular events.

Security Service: which provides security facilities, such as authentication, non-repudiation and audit trails.

Concurrency Service: which provides a lock manager.

Time Service: which offers a service for clock synchronisation over multiple computers, a feature necessary for accurate timestamping in distributed applications.

Like all other CORBA services, these appear as objects with specified interfaces, accessed via the ORB.

11.2 CORBA Interfaces and CORBA IDL

As in the case of RMI, it is necessary to define an *interface* which the server presents to its clients. This interface is defined using an IDL. The CORBA IDL has a syntax based on C++, with well-defined mappings of IDL types, constants and exceptions to constructs in a range of implementation languages such as C++ itself, Java, C, SmallTalk, Cobol and other languages. This makes CORBA especially valuable for developing applications where different parts of the application software have been (or will be) implemented in different languages. In these notes, we shall confine our attention to the IDL to Java mapping. For details of other mappings, you need to consult the CORBA documentation [31].

An interface definition for the Blipper server is shown in Figure 11.2. Comparing this with the RMI interface definition given in Figure 10.4, you notice:

IDL type	Java type
boolean	boolean
char	char
octet	byte
string	java.lang.String
long	int
long long	long
float	float
double	double
fixed	java.math.BigDecimal

Table 11.1: Mapping between CORBA IDL types and Java types

- The use of “C++” types. The mapping between some of the most important IDL and Java basic types is shown in Table 11.1.
- The annotations indicating the direction in which parameter values flow in relation to the server: `in` means that the parameter carries input to the server, `out` that it carries output from the server, and `in out` that the parameter carries both input and output.
- The addition of a method `shutdown`, whose implementation must shut down the server. This is a technical convenience which is standard practice in CORBA-based implementations.
- The removal of information about the generation of remote exceptions.

Although not shown in the example here, the interface may, in addition to definitions of methods which can be activated on the server, include definitions of exceptions and data types, and the methods may be declared as raising named exceptions.

If the aim is to produce a Java implementation, the interface definition needs to be compiled by using the *Java IDL* compiler. If the definition is in, say, `Blip.idl`, this can be done by using the Unix command:

```
idlj -fall Blip.idl
```

This will produce a number of `.java` files in the directory `BlipApp`, which are needed for the subsequent compilation of the client and server. Amongst other things, these files will include definitions of one or more helper classes, for example for dealing with complex types and with features of the IDL which Java does not directly support, such as `out` parameters and data type definitions.

11.3 CORBA Clients and Servers

Based on the required interface definition, client and server code are developed in a manner quite similar to that used for RMI. In rough terms, the server has to register its presence with the ORB and its naming service, and the client likewise has to register its presence and obtain a reference to the server by looking up in the naming service, after which it can invoke the methods of the server object. In detail, things look rather more complicated. An extra complication is that there are several quite different styles of writing servers, so if you look in other books on Java and CORBA you may find quite different sets of instructions for what to do. The instructions given here are based on the use of the *Portable Object Adapter (POA)*, which, as previously mentioned, is the standard way of implementing servers in Java 2 SE version 1.4, based on Corba version 2.3. The POA relies on what is known as an *Inheritance Model*, so that the implementation of the IDL interface uses an implementation class which extends the skeleton generated by the IDL compiler.

In the Blipper example, compilation of the interface `Blip` (see Figure 11.2) in file `Blip.idl` will produce a skeleton `BlipPOA.java` containing a definition of an abstract class `BlipPOA`. On the server side, `BlipPOA` is used as the superclass for a *servant class* `BlipImpl`, which contains implementations of the methods defined in the IDL. `BlipPOA` inherits in its turn from `org.omg.PortableServer.Servant`, the base class for all POA servant implementations. The servant, which is shown in Figure 11.3 on the following page, cooperates with the actual server class, `BlipServer`, shown in Figure 11.4 on page 79. As usual, the server class contains a `main()` method, which here must perform all the basic bookkeeping in connection with the ORB, including:

- Creating and initialising an instance of an ORB by calling the ORB's `init()` method. This is typically used to pass the server's command line arguments, which makes it possible to set properties for the server at runtime.
- Getting a reference to the root POA and activating the POA manager.
- Creating an instance of the servant and registering it with the ORB.
- Getting a CORBA object reference for a naming context in which to register the new CORBA object, and registering the object with the COS Naming Service.
- Waiting for calls from the client which invoke the new object.

It should be clear that large parts of this code are independent of the specific servant, and can be used in other applications. The servant and server code are kept in the same file, named after the server, here `BlipTarget.java`, and are compiled in the usual way to produce a class file `BlipTarget.class`.

The client code is shown in Figure 11.5 on page 81, and as in the RMI case (Figure 10.6) contains a `main` method, with a number of calls of server methods, embedded in administrative code related to the CORBA environment. The administrative code is responsible for:

```

// Package containing stubs
import BlipApp.*;
// Packages for using the COS Naming Service
import org.omg.CosNaming.*;
import org.omg.CosNaming.NamingContextPackage.*;
// Packages for general use in CORBA
import org.omg.CORBA.*;
// Packages for Portable Server inheritance model
import org.omg.PortableServer.*;
import org.omg.PortableServer.POA;

import java.util.*;

class BlipImpl extends BlipPOA
{ private ORB orb;
  static int bcount;
  static boolean active;

  public void setORB(ORB orb_val)
  { orb = orb_val;
  }

  public void start(int n)
  { System.out.println(new Date() + ": Target activated.");
    bcount = n;
    active = true;
  }

  public int add(int i)
  { if( active ) bcount = bcount + i;
    return bcount;
  }

  public void stop()
  { System.out.println(new Date() + ": Target deactivated.");
    active = false;
  }

  public void shutdown()
  { orb.shutdown( false );
  }
}

```

Figure 11.3: Implementation of the servant class for the Blipper

The remainder of the server code is shown in Figure 11.4.

```

public class BlipTarget
{ public static void main(String args[])
  { try
    { ORB orb = ORB.init(args, null);
      POA rootpoa =
        POAHelper.narrow( orb.resolve_initial_references("RootPOA") );
      rootpoa.the_POAManager().activate();
      // Create servant and register it with ORB
      BlipImpl blipImpl = new BlipImpl();
      blipImpl.setORB( orb );
      // Get object reference from servant
      org.omg.CORBA.Object ref = rootpoa.servant_to_reference( blipImpl );
      Blip href = BlipHelper.narrow( ref );
      // Get root naming context
      org.omg.CORBA.Object objRef =
        orb.resolve_initial_references( "NameService" );
      NamingContextExt ncRef = NamingContextExtHelper.narrow( objRef );
      // Bind object reference in Naming Service
      String service = "Blip";
      NameComponent path[] = ncRef.to_name( service );
      ncRef.rebind( path, href );
      // Wait for incoming calls from clients
      System.out.println(new Date() + ": Server "
                          + service + " waiting for calls.");

      orb.run();
    }
    catch(Exception e)
    { System.err.println("Blip server exception: " + e );
      e.printStackTrace(); }

    System.out.println(new Date() + ": Server "
                      + service + " closing down.");
  }
}

```

Figure 11.4: Implementation of a CORBA server for the Blipper

- Creating and initialising an instance of an ORB by calling the ORB's `init()` method. This is typically used to pass the client's command line arguments, which makes it possible to set properties for the client at runtime.
- Getting a CORBA object reference for a naming context in which to look up the new CORBA object, and looking up the object via the COS Naming Service.
- Shutting down the ORB after all the client calls have been made.

The client code is compiled in the usual way. If it is kept in the file `BlipClient.java`, the compiled code will appear in the class file `BlipClient.class`.

To put the entire application together, it is necessary, after compiling the interface and the server and client code as described above, also to compile the `.java` files produced by the IDL compiler from the interface definition. In relation to the directory containing the interface definition `Blip.idl`, these files are placed in subdirectory `BlipApp`, and can be compiled by the Unix command:

```
javac BlipApp/*.java
```

This produces a set of class files in the `BlipApp` directory. With these available, the application can be run by performing the following steps:

1. Start the name service daemon `orbd` as a background task by using the Unix command:

```
orbd -ORBInitialPort 1050 &
```

This starts the daemon and specifies that port 1050 is to be used for contacting the name service.
2. Start the server for the application as a background task. In this example, this can be done by using the Unix command:

```
java BlipTarget -ORBInitialPort 1050 -ORBInitialHost localhost &
```

This is appropriate if the name server is running on same machine as the Blip server. If the name server is to run on a remote host, the name of this host should be substituted for `localhost`.
3. Start the client. In this example, this can be done by using the Unix command:

```
java BlipClient -ORBInitialPort 1050 -ORBInitialHost localhost
```

As in the case of the server, this is appropriate if the name server is running on the same machine as the Blip client. If the name server is to run on a remote host, the name of this host should be substituted for `localhost`.
4. When the client has finished running, it will close the ORB down by invoking the `shutdown(false)` method. However, this still leaves the name server demon `orbd` running, waiting for things to do. You must explicitly kill the Unix process which is running the name server: Use the Unix `ps` command to look up the number of the `orbd` process, then kill the process explicitly, for example by using the Unix command:

```

import BlipApp.*;
import org.omg.CosNaming.*;
import org.omg.CosNaming.NamingContextPackage.*;
import org.omg.CORBA.*;
import java.util.*;

public class BlipClient
{ static Blip blipImpl;

  public void blip(Blip b, int i)
  {
    int nblip = b.add(i);
    System.out.println(new Date() + ": " + Integer.toString(nblip,10)
                      + " blips");
  }

  public static void main(String args[])
  { try
    { BlipClient b = new BlipClient();
      // Create and initialise the ORB
      ORB orb = ORB.init(args, null);
      // Get root naming context
      org.omg.CORBA.Object objRef =
        orb.resolve_initial_references("NameService");
      NamingContextExt ncRef = NamingContextExtHelper.narrow( objRef );
      // Resolve object reference in Naming Service
      String service = "Blip";
      blipImpl = BlipHelper.narrow( ncRef.resolve_str(service) );
      System.out.println("Got handle on server object: " + blipImpl );
      // Call server methods
      blipImpl.start(20);
      b.blip(blipImpl, 1);
      b.blip(blipImpl, 4);
      blipImpl.stop();
      blipImpl.shutdown();
    }
    catch (Exception e)
    { System.out.println("Blipper client exception: " + e );
      e.printStackTrace(System.out); }

  }
}

```

Figure 11.5: Implementation of a CORBA client for the Blipper

```
kill -9 12345
```

where 12345 (or whatever) is the number of the process.

As with RMI, you may like (or need) to find out more details about how to use CORBA in connection with Java. However, you need to be careful what you read: Although there are several books on the subject, many of them are not up to date, because they deal with how to use older versions of Java, or older versions of CORBA, or other techniques for implementing the server-side code. A current tutorial and a glossary of terms can be found on the Web at:

```
http://java.sun.com/j2se/1.4/docs/guide/idl/jidlExample.html
```

```
http://java.sun.com/j2se/1.4/docs/guide/idl/jidlGlossary.html
```

These contain a number of links to further material on CORBA, the CORBA-to-Java mapping and other useful topics.

This short presentation of CORBA has focussed on using CORBA in the classic manner, with interfaces described in the CORBA IDL, and using standard CORBA tools for producing an implementation in a particular programming language, in this case Java. This is not the only approach to combining CORBA and Java. One common alternative is to use the RMI-based Internet Inter-ORB Protocol, usually known as *RMI-IIOP*, which makes it possible to program using RMI conventions, but to use IIOP as the underlying transport mechanism. RMI-IIOP provides interoperability with other CORBA objects implemented in various languages *if all the remote interfaces are defined as Java RMI interfaces*. Documentation on RMI-IIOP and a tutorial covering this approach can be found on the Web at:

```
http://java.sun.com/j2se/1.4/docs/guide/rmi-iiop/index.html
```

```
http://java.sun.com/j2se/1.4/docs/guide/rmi-iiop/rmiiopexample.html
```

12 Web Services and SOAP

RMI and CORBA represent approaches to programming distributed systems which essentially build on standard network programming techniques for setting up socket-based communication between the client and server, and for passing serialised representations of values and objects between them. The focus is largely on hiding the details of how this is done from the programmer. A rather different approach to distributed object-oriented programming is the so-called Web Services paradigm, where the arguments and results are passed to the object via a Web server. The advantage of this is that in order to use

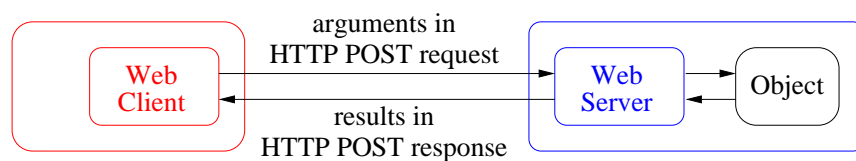

Figure 12.1: Object access in simple Web services

the technique you only need to have a Web server with suitable capabilities. The object itself is just a Web resource. Typically, the arguments for the method to be invoked are transmitted in an HTTP POST request (see page 52) from a Web client to a Web server, which passes them on to the object whose method is to be invoked; the results are passed back the opposite way in a POST response. This is illustrated in Figure 12.1.

A commonly used protocol for this purpose is the *Simple Object Access Protocol (SOAP)*, defined in [37]. This is in reality just an extension to HTTP, which introduces some new forms of header line which enable the remote object to be identified. The description of the method to be invoked and the arguments to be used is provided as a so-called *SOAP request* which forms the body of the HTTP POST request. Similarly, the results returned by the invoked method are returned in the form of a *SOAP response* which makes up the body of the HTTP POST response.

SOAP requests and responses are both examples of *SOAP messages*. These are encoded in *Extensible Markup Language (XML)* [36], a notation originally developed for describing the structure of documents, but now more generally employed for describing hierarchically structured data of any kind. Each SOAP message is syntactically an *XML document*, made up of a *SOAP envelope*, which contains zero or more header elements describing attributes, an optional *SOAP header* and a mandatory *SOAP body*. The header may contain one or more *header entries*, typically specifying instructions for how to process the body, and the body may contain one or more *body entries*. This hierarchical structure is illustrated in Figure 12.2. Each of the parts is syntactically an *XML element*. We shall describe the structure of such elements in more detail below.

Let us now return to the simple Blipper application, which we have seen implementations of based on RMI and CORBA. A complete HTTP request for invoking the `add` method of the Blipper could in a simple case then be as shown in Figure 12.3. The HTTP request header indicates that the resource is to be found via the URI `/Blipper` on host `www.blipper.dtu.dk`. The `SOAPAction:` header field characterises this request as being a SOAP request. The information after the keyword `SOAPAction` indicates the intent of the request. Typically this is just specified as the URI of the resource which will handle the request, and thus contains the same information as the path specified in the HTTP request header.

As the body of the HTTP request is an XML encoded SOAP message, the `Content-type`

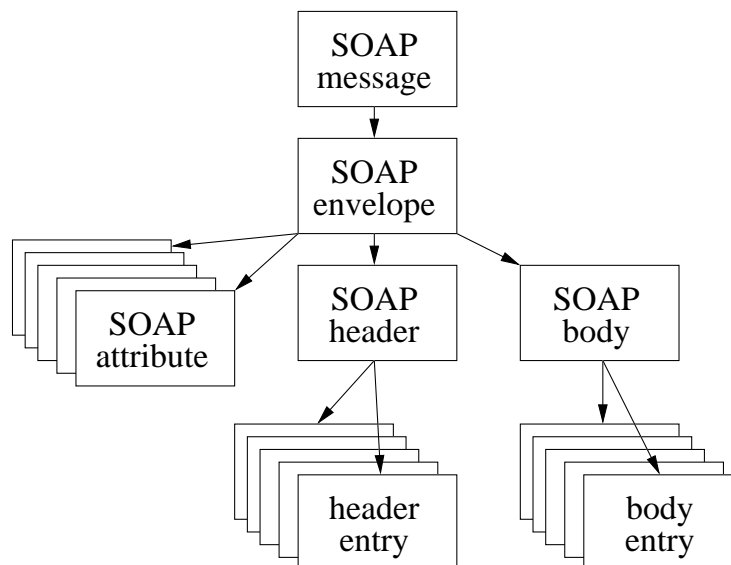

Figure 12.2: Hierarchical structure of a SOAP message

```

POST /Blipper HTTP/1.1
Host: www.blipper.dtu.dk
Content-type: text/xml; charset="utf-8"
Content-length: 448
SOAPAction: "/Blipper"

```

```

<?xml version="1.0"?>
<SOAP-ENV:Envelope
  xmlns:SOAP-ENC:encodingStyle="http://schemas.xmlsoap.org/soap/encoding/"
  xmlns:SOAP-ENV:encodingStyle="http://schemas.xmlsoap.org/soap/envelope/"
  xmlns:xsd="http://www.w3.org/2001/XMLSchema"
  xmlns:xsi="http://www.w3.org/2001/XMLSchema-instance">
  <SOAP-ENV:Body>
    <m:add xmlns:m="http://www.soapware.org/">
      <n xsi:type="xsd:int"> 3 </n>
    </m:add>
  </SOAP-ENV:Body>
</SOAP-ENV:Envelope>

```

Figure 12.3: An HTTP request to invoke the Blipper add method

The request header is in *typewriter* font and the request body is in *italic typewriter* font. This body has the form of an XML encoded SOAP message. The box contains the body of the message.

header field specifies that the body is of type `text/xml`. The character set defaults to `us-ascii`, but Unicode character sets such as `utf-8` or `utf-16` are usually chosen, as they generally ensure better interoperability.

12.1 XML Encoding of the Request Message

The body of the request must be a well-formed XML document. This starts with an *XML declaration* specifying the XML version being used. The remainder of the body is an XML element which represents the SOAP Envelope of the message. In this simple example, the SOAP Envelope contains a SOAP Body but no SOAP Header; these must also (if present) be XML elements. Like the HTML elements which we have seen earlier, such elements start and end with matching tags which identify the content of the element. Thus the SOAP Envelope starts with a `<SOAP-ENV:Envelope>` start tag and finishes with `</SOAP-ENV:Envelope>` end tag, and similarly for the other elements which appear. The names of the tags must be unique within the *XML namespace* which is specified by the namespace identifier at the beginning of the tag: In the case of the Envelope, the `SOAP-ENV:` namespace. Details of which namespaces are used are given by namespace declarations which are embedded in the Envelope start tag. Each namespace declaration starts with the name `xmlns:` (which is itself the name of a standard namespace) and specifies a resource where the relevant mapping between names and their meanings is to be found.

The SOAP Body within the Envelope of the request specifies the *method* to be invoked and the *argument values* to be used. The method is specified by an XML element delimited by `<m>` tags, which here of course refers to the method `add` as defined within the namespace specified by `http://www.soapware.org/`. The argument values are embedded within the method element, with tags identified by the names of the arguments. Since `add` has a single argument `n` of type integer, a single argument element is used, here with the content:

```
<n xsi:type="xsd:int"> 3 </n>
```

which specifies the type of the argument (here `int` from the standard XML schema definition namespace `xsd:`) and its value (here 3).

12.2 SOAP Response Messages

Whereas SOAP request messages are used to convey information to the object whose method is to be invoked, SOAP response messages correspondingly convey return information to the calling system. Responses fall into two categories:

1. Normal responses, carrying return values such as function values.

2. Fault responses, indicating that the method invocation has failed.

Examples in the case of the `add` method are shown in Figure 12.4. In the case of a normal response, the SOAP Body contains a single XML element whose tag name is derived from the name of the invoked method by appending the character sequence `Response`, here giving the tag `<m:addResponse>`. This element contains a single XML element which describes the return value from the invocation, here:

```
<addressresult xsi:type="xsd:int"> 27 </addressresult>
```

which describes a single integer with value 27. The tag for this return element must match the name of the object created by the Client to contain the return value (see Section 12.4 below).

In the case of a fault response, the SOAP body contains a single XML element with the tag `<SOAP-ENV:Fault>`, which contains a description of the fault. Typically, this description contains two XML elements: a *faultcode* (tag `<faultcode>`) and an explanatory text (tag `<faultstring>`). Currently, four standard faultcodes are defined, as listed in Table 12.1.

Faultcode	Explanation
VersionMismatch	An invalid namespace was referred to in the SOAP Envelope element.
MustUnderstand	One of the immediate children of the SOAP Header element contained a <i>mustUnderstand</i> attribute, but could not be dealt with.
Client	The SOAP request was incorrectly formed or contained insufficient information to enable it to be processed.
Server	The server was unable to process the SOAP request (even though it was correctly formed).

Table 12.1: Standard faultcodes in SOAP

12.3 SOAP Types

The types which may be used to specify method arguments and results in SOAP are a subset of the types permitted in XML, and described in reference [38]. As in most modern programming languages, SOAP types fall into two categories: *Simple types* and *compound types*. An element of a simple type describes a scalar value, i.e. a value without distinguishable inner parts, such as an integer, a real, or a string. Some of the simple types available in version 1.1 of SOAP are summarised in Table 12.2. The namespace `xsd` referred to in most of the type names is the XML standard namespace which contains the definitions of XML Schema Data types.

(a) HTTP/1.1 200 OK

Content-type: text/xml; charset="utf-8"

Content-length: 481

Date: Wed, 01 Oct 2003 04:05:06 GMT

```

<?xml version="1.0"?>
<SOAP-ENV:Envelope
  xmlns:SOAP-ENC:encodingStyle="http://schemas.xmlsoap.org/soap/encoding/"
  xmlns:SOAP-ENV:encodingStyle="http://schemas.xmlsoap.org/soap/envelope/"
  xmlns:xsd="http://www.w3.org/2001/XMLSchema"
  xmlns:xsi="http://www.w3.org/2001/XMLSchema-instance">
  <SOAP-ENV:Body>
    <m:addResponse xmlns:m="http://www.soapware.org/">
      <addresult xsi:type="xsd:int"> 27 </addresult>
    </m:addResponse>
  </SOAP-ENV:Body>
</SOAP-ENV:Envelope>

```

(b) HTTP/1.1 500 Server Error

Content-type: text/xml; charset="utf-8"

Content-length: 552

Date: Wed, 01 Oct 2003 04:05:08 GMT

```

<?xml version="1.0"?>
<SOAP-ENV:Envelope
  xmlns:SOAP-ENC:encodingStyle="http://schemas.xmlsoap.org/soap/encoding/"
  xmlns:SOAP-ENV:encodingStyle="http://schemas.xmlsoap.org/soap/envelope/"
  xmlns:xsd="http://www.w3.org/2001/XMLSchema"
  xmlns:xsi="http://www.w3.org/2001/XMLSchema-instance">
  <SOAP-ENV:Body>
    <SOAP-ENV:Fault>
      <faultcode>SOAP-ENV:Client</faultcode>
      <faultstring>Client error.
        Too many parameters in call of "add".
      </faultstring>
    </SOAP-ENV:Fault>
  </SOAP-ENV:Body>
</SOAP-ENV:Envelope>

```

Figure 12.4: HTTP responses to an invocation of the Blipper add method

- (a) Normal response with return value.
- (b) Fault response due to an error on the client side.

The response headers are in *typewriter* font and the response bodies in *italic typewriter* font. The body has the form of an XML encoded SOAP message. The box contains the body of the message.

Set of values in type	Type name	Value Example
Decimal fractions	xsd:decimal	12.345
Signed floating point numbers	xsd:float	-12.345E3
Signed double precision numbers	xsd:double	-12.345E3
Boolean values	xsd:boolean	true
Strings of characters	xsd:string	good morning
Date/times	xsd:dateTime	2001-10-01T04:05:06
Base64 encoded binary	SOAP-ENC:base64	GWaIP2A=
32-bit signed integers	xsd:int	-1234567
16-bit signed integers	xsd:short	-1234
Negative integers	xsd:negativeInteger	-32768

Table 12.2: Simple SOAP types

As in many programming languages, XML also makes it possible to derive *enumerations*, which are sets of values taken from some (simple) base type.

An element of a compound type is made up of one or more individually identifiable sub-parts. Examples are structs, arrays, vectors and objects. In SOAP, a *struct* is merely an XML element with named sub-elements, which themselves can be of any (possibly compound) types. The names of the sub-elements in a struct are significant; their order is not significant. For example:

```
<e:Bibentry>
  <author>Alfons Aaberg</author>
  <title>My life as a latchkey child</title>
  <pubyear>2015</pubyear>
</e:Bibentry>
```

is a value of a struct type with three elements, two strings and an integer.

An *array* is an ordered sequence of elements. Thus the order of the elements is significant, but the names of the elements are not. The elements may be of the same type, as in:

```
<Primes SOAP-ENC:arrayType="xsd:int [5]">
  <item xsi:type="xsd:int">2</item>
  <item xsi:type="xsd:int">3</item>
  <item xsi:type="xsd:int">5</item>
  <item xsi:type="xsd:int">7</item>
  <item xsi:type="xsd:int">11</item>
</Primes>
```

which is an example of an array with five elements of `int` type (i.e. an array of type `int[5]`). Or they may be of different types, as in:

```
<Notes SOAP-ENC:arrayType="xsd:ur-type[4]">
  <item xsi:type="xsd:decimal">11.3</item>
  <item xsi:type="xsd:float">-27.517E03</item>
  <item xsi:type="xsd:string">Monday morning</item>
  <item xsi:type="xsd:string">Friday after 3.00pm</item>
</Notes>
```

which is an example of an array with four elements of mixed types: a decimal fraction, a floating point number and two strings. Note that the type of the array is given as `ur-type[4]`, where `ur-type` denotes *the union of all types*.

In XML it is possible to define and give names to complex derived types and to new derived types. We shall not go into details here, but refer you to the XML documentation on datatypes [38].

12.4 Web Service Clients and Servers

It would obviously be possible to implement the Client and Server by means of programs which directly create and transmit or receive and interpret the HTTP requests and responses required. Not surprisingly, however, there are several programming environments which hide all this from the user, just as RMI provides a way of programming remote method invocations which hides the details of the underlying exchange of messages. In these notes we shall briefly describe the Java environment associated with the *Apache SOAP* system. Other well-known systems which support the use of SOAP are *SOAP::Lite*, which is based on Perl, and the Microsoft *.NET* environment; for details of these, you will need to consult the relevant documentation.

To implement the server using Apache SOAP, which is based on Java, it is necessary to define and implement a Java interface describing the service. In the case of the Blipper service, the interface and its implementation could be as shown in Figure 12.5. Note that this strongly resembles the non-distributed Blipper implementation shown in Figure 10.3. This interface and its implementation are compiled in the usual way. The web service then needs to be *deployed* on some suitable host system, so that it becomes available for use and can be found by the SOAP lookup service. In particular, this involves *publishing* the existence of the web service in a *service registry*, in a manner analogous to what we have seen in the case of Corba. Details of how to do this can be found on the Web at:

<http://xml.apache.org/soap/docs/index.html>

```
public interface IBlip
{ public void start(int n);
  public int  add(int i);
  public void stop();
}
```

=====

```
public class WSBlip implements IBlip
{
    static int bcount;
    static boolean active;

    public void start(int n)
    { System.out.println(new Date() + ": Target activated.");
      bcount = n;
      active = true;
    }

    public int add(int i)
    { if( active ) bcount = bcount + i;
      return bcount;
    }

    public void stop()
    { System.out.println(new Date() + ": Target deactivated.");
      active = false;
    }
}
```

Figure 12.5: The service interface and its implementation for the Blipper Web Service in Apache SOAP

The Client for an Apache SOAP web service has to construct the SOAP messages to be sent to the Server, and must receive and analyse the responses. To facilitate this, Apache SOAP provides a number of classes from packages under `org.apache.soap` for constructing and manipulating essential objects for SOAP. The most important of these are summarised in Figure 12.6.

Class	Objects
RPCMessage	SOAP requests.
Call	Remote method invocations.
Parameter	Arguments or return values of methods.
Response	Responses to calls.
Fault	SOAP fault elements.

Figure 12.6: Main classes in the Apache SOAP environment

A complete skeleton for a Client for the Blipper web service is shown in Figure 12.7. To complete the Client, it is necessary to provide implementations for all the methods; as an example, the complete implementation of the `add` method is shown in Figure 12.8. It is important to note that, in relation to the examples which we have seen previously, the methods all carry a URL as an extra parameter, namely the URL at which the service is available.

To make use of a web service in a practical application a description of the service must be produced in a standard format, encoded as an XML document. This document is structured according to the rules of the *Web Service Description Language (WSDL)*, and includes a definition of the service interface, a definition of the service implementation, and (if it is a concrete implementation rather than an abstract service description which is being described) a description of the service endpoint (typically the URL used for contacting the service). As in the cases of RMI and CORBA, the description must be propagated to the *service registry* as part of the process of *publication* of the service. A protocol known as the *Universal Description, Discovery and Integration (UDDI)* protocol is used by service providers for registering the description and by service requestors (i.e. Clients) for discovering the service. Thus in reality, the Web service architecture is considerably more complex than the simple description at the start of Section 12 might get you to imagine, as it essentially consists of several layers which are added on to the chosen data transfer protocol, which in full generality does not even need to be HTTP. The complete architecture of the Web Services protocol stack is illustrated conceptually in Figure 12.9. The function of the uppermost layer, associated with Service Flow, is to make it possible to *compose* simpler web services into more complex ones. The way in which this layer works is not yet 100% standardised among various suppliers of Web services, and we shall not go into details about it in these notes. A good review of the entire architecture from the perspective of one of the main players in the Web services arena (IBM) can be found on

```
import java.io.*;
import java.net.*;
import java.util.*;
import org.apache.soap.util.xml.*;
import org.apache.soap.*;
import org.apache.soap.rpc.*;

public class BlipClient
{ public void blip(URL url, int i) throws Exception
  { int nblip = add(url, i)
    System.out.println(new Date() + ": " + Integer.toString(nblip,10)
                      + " blips");
  }

  public static void main(String[] args)
  { try
    { URL url = new URL("http://xxxxxxxxx");
      start(url,20);
      blip (url, 1);
      blip (url, 4);
      stop (url);
    }
    catch (Exception e)
    { e.printStackTrace(); }
  }

  public static void start(URL url, int i) throws Exception
  { // implementation of start
  }

  public static int add(URL url, int n) throws Exception
  { // implementation of add
  }

  public static int stop(URL url) throws Exception
  { // implementation of stop
  }
}
```

Figure 12.7: Skeleton for a Java client for the Blipper web service

```
public static int add(URL url, int n) throws Exception
{ // Set up call of remote method
  Call call = new Call();
  // SOAP encoding specification
  String encodingStyleURI = Constants.NS_URI_SOAP_ENC;
  call.setEncodingStyleURI( encodingStyleURI );
  // Set parameters for service locator
  call.setTargetObjectURI( "urn:xmethods-Blipper" );
  call.setMethodName( "add" );

  // Create vector with parameter(s) and insert into Call object
  Parameter param1 = new Parameter("n", int.class, n, null);
  Vector params = new Vector();
  params.addElement( param1 );
  call.setParams( params );

  // Invoke the remote service
  Response resp = call.invoke(url, "/Blipper");

  // Deal with the response
  if( resp.generatedFault() )
  { // The call did not succeed.
    Fault f = resp.getFault();
    System.err.println( "Fault= " + f.getFaultCode()
                      + ", " + f.getFaultString() );
    throw new Exception();
  } else
  { // The call was successful. Retrieve return value.
    Parameter result = resp.getReturnValue();
    Int addobj = (Int) result.getValue();
    return addobj.intValue();
  }
}
```

Figure 12.8: Implementation of method add for the Blipper web service

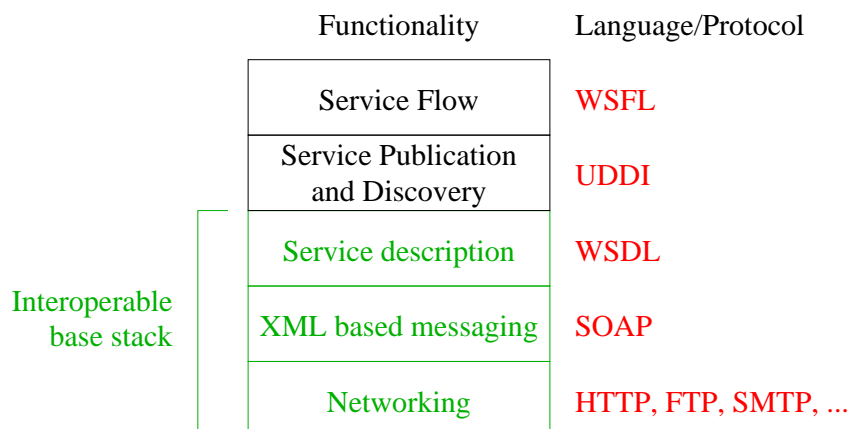

Figure 12.9: Web Services Architecture conceptual stack

the Web at:

<http://www-3.ibm.com/software/solutions/webservices/pdf/WSCA.pdf>

while organisations such as SoapWare, which acts as a forum for SOAP developers, have produced a number of more specialised tutorials on the use of SOAP, which can be found on SoapWare’s website at www.soapware.org.

13 Further Reading

There are many books and other sources for more information about the topics of these notes. For a gentle, but more detailed, introduction to Internet protocols, Comer’s “*Computer Networks and Internets*” [4] is an excellent starting point. More information about computer networks in general can be found in the books by Tanenbaum [35], Halsall [7] and Stallings [33], while local area networks are treated in detail in [34]. Of course, these books cover a lot of ground, and run to several hundred pages, so they are not really suitable as introductory material.

For full details of Internet protocols, you need to refer to the Internet *Requests for Comments* (RFC’s), of which several important ones are listed in the Bibliography. These can all be obtained from the Internet itself via the Web page:

<http://www.rfc-editor.org/rfcsearch.html>

from where you can search for and retrieve RFCs by number or keyword. It is not possible to see directly from an RFC which status it has, i.e. whether it describes an accepted

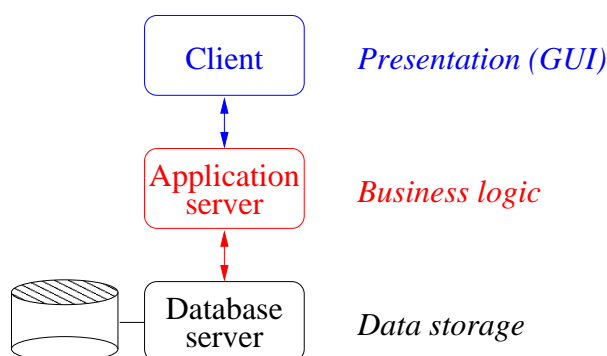

Figure 13.1: A multi-tier system with three tiers

The *Client* is a client of the middle-tier server, which deals with the actual application and is itself a client of the database server in the lowest tier.

standard, a proposed standard or just a draft for comment. To find this out, you need to look at the latest version of the list of Internet standards; this list is itself an RFC, currently RFC3300. Standards from the International Telecommunications Union (ITU-T), the International Organization for Standardization (ISO) and IEEE can be purchased from these organisations.

These notes have focussed on how to construct distributed applications based on the simplest form of client-server model, with one or more clients and a single server. While this is an important and very much used model, it is by no means the only one. Many interesting systems use *multi-tier* models, where a server can itself be a client for one or more other servers. A simple example of this is shown in Figure 13.1, which shows a three-tier architecture, involving presentation, an actual application and data storage.

A further development of this is to use hierarchical architectures, in which participating processes are organised in a tree-like structure, and where information passes up and down the branches of the tree. Other systems make use of a set of cooperating *agents*. Agents may be static (permanently resident on particular systems) or mobile, and exchange information in an intelligent manner in order to solve some problem. A good source of information about this type of system is the book by Omicini et al. [32], which describes the architecture of agent systems and how agents communicate in order to solve their given problems, while reference [2] gives a specific example of the use of agents for information retrieval in the Internet. Finally, you may find it interesting to look at the so-called *GRID* architecture, a recent trend in the design of very large distributed systems, which potentially offers users global access to computational power and other resources. The essence of a GRID is – by analogy with the electric grid – that it offers access to resources without the users having any idea where the resources actually come from. Reference [6] describes the ideas in detail.

References

- [1] Andrew D. Birrell and Bruce Jay Nelson. Implementing remote procedure calls. *ACM Transactions on Computer Systems*, 2(1):29–59, February 1984.
- [2] B. Brewington, R. Gray, K. Moizumi, D. Kotz, G. Cybenko, and D. Rus. Mobile agents for distributed information retrieval. In M. Klusch, editor, *Intelligent Information Agents*, pages 355–395. Springer-Verlag, 1999.
- [3] CCITT. *Recommendation G.711: Pulse Code Modulation (PCM) of Voice Frequencies*, 1972.
- [4] D. Comer. *Computer Networks and Internets*. Prentice Hall, second edition, 1999. ISBN 0-13-084222-2.
- [5] R. Fielding, J. C. Mogul, H. Frystyk, L. Masinter, P. Leach, and T. Berners-Lee. *RFC 2616: Hypertext Transfer Protocol – HTTP/1.1*, June 1999.
- [6] Ian Foster and Carl Kesselman, editors. *The Grid: Blueprint for a New Computing Infrastructure*. Morgan Kaufmann, 1999. ISBN 1-55860-475-8.
- [7] F. Halsall. *Data Communications and Computer Networks and OSI*. Addison-Wesley, fourth edition, 1995. ISBN 0-20-142293-X.
- [8] C. A. R. Hoare. *Communicating Sequential Processes*. Prentice-Hall International, 1985.
- [9] International Standards Organisation. *International Standard ISO7498: Information Processing Systems – Open Systems Interconnection – Basic Reference Model*, 1984. This is identical to CCITT Recommendation X.200.
- [10] International Standards Organisation. *International Standard ISO8807: Information Processing Systems – Open Systems Interconnection – LOTOS: A Formal Description Technique based on the Temporal Ordering of Observational Behaviour*, 1988.
- [11] International Standards Organisation. *International Standard ISO9074: Information Processing Systems – Open Systems Interconnection – Estelle (Formal Description Technique based on an Extended State Transition Model)*, 1989.
- [12] International Standards Organisation. *International Standard ISO8802-4: Information processing systems – Local area Networks – Part 4: Token bus access method and physical layer specification*, 1990. This is identical to IEEE Standard 802.4.
- [13] International Standards Organisation. *International Standard ISO8802-5: Information processing systems – Local area Networks – Part 5: Token ring access method and physical layer specification*, 1990. This is identical to IEEE Standard 802.5.
- [14] International Standards Organisation. *International Standard ISO11172-2: Information Technology – Coding of Moving Pictures and Associated Audio for Digital Storage Media at up to about 1,5 Mbit/s – Part 2: Video*, 1993.
- [15] International Standards Organisation. *International Standard ISO10918-1: Information Technology – Digital compression and coding of continuous-tone still images – Part 1: Requirements and guidelines*, 1994.
- [16] Internet. *RFC 768: User Datagram Protocol (UDP)*, August 1980.

- [17] Internet. *RFC 791: Internet Protocol*, September 1981. Identical to U.S. Department of Defense: MIL-STD 1777: *Military Standard Internet Protocol*.
- [18] Internet. *RFC 793: Transmission Control Protocol*, September 1981. Identical to U.S. Department of Defense: MIL-STD 1778: *Military Standard Transmission Control Protocol*.
- [19] Internet. *RFC 821: Simple Mail Transfer Protocol (SMTP)*, August 1982.
- [20] Internet. *RFC 1883: Internet Protocol: Version 6 (IPv6) Specification*, December 1995.
- [21] Internet. *RFC 1939: Post Office Protocol – Version 3*, May 1996.
- [22] Internet. *RFC 2045: Multipurpose Internet Mail Extensions (MIME) Part One: Format of Internet Message Bodies*, November 1996.
- [23] Internet. *RFC 2046: Multipurpose Internet Mail Extensions (MIME) Part Two: Media Types*, November 1996.
- [24] Internet. *RFC 2060: Internet Message Access Protocol, Version 4, rev.1*, December 1996.
- [25] Internet. *RFC 2131: Dynamic Host Configuration Protocol*, March 1997.
- [26] Internet. *RFC 2373: IP Version 6 Addressing Architecture*, July 1998.
- [27] Internet. *RFC 2396: Uniform Resource Identifiers (URI): Generic Syntax*, August 1998.
- [28] ITU-T. *Recommendation I.321: B-ISDN Protocol Reference Model*, 1972.
- [29] ITU-T. *Recommendation Z.100: Specification and Description Language SDL*, 2002.
- [30] R. Milner. *Communication and Concurrency*. Prentice-Hall International, 1989.
- [31] Object Management Group, Inc. *Common Object Request Broker Architecture, V2.3.1*, October 1999.
- [32] A. Omicini, F. Zambonelli, M. Klusch, and R. Tolksdorf, editors. *Coordination of Internet Agents: Models, Technologies, and Applications*. Springer-Verlag, 2001. ISBN 3-540-41613-7.
- [33] W. Stallings. *Data and Computer Communications*. Prentice Hall, fifth edition, 1997. ISBN 0-13-084370-9.
- [34] W. Stallings. *Local and Metropolitan Area Networks*. Prentice Hall, sixth edition, 2000. ISBN 0-13-012939-9.
- [35] A. Tanenbaum. *Computer Networks*. Prentice Hall, fourth edition, 2002. ISBN 0-13-066102-3.
- [36] W3C. *Extensible Markup Language (XML) 1.0*, second edition, October 2000.
- [37] W3C. *Simple Object Access Protocol (SOAP) 1.1*, May 2000.
- [38] W3C. *XML Schema Part 2: Datatypes*, May 2001.

Index

- Access Point, 26
- acknowledgment, 35
- active server page, 52
- agent, 96
- applet, 52
- assigned port, 34
- at-least-once semantics, 62
- at-most-once semantics, 62
- authentication, 14
- availability, 15

- base64 encoding, 46
- binding, 64–66
- Bit Error Rate (BER), 12
- bridge, 22
- Broadband ISDN (B-ISDN), 10
- BSD socket, 55

- client, 39, 63
- Common Object Services (COS), 75
- communication link, 3
- communication node, 3
- component-based programming, 73
- confidentiality, 14
- contention, 24
- CORBA, 73–82
 - client, 77–81
 - DII, 74
 - IDL, 75
 - interface, 75
 - object adapter, 74
 - servant, 77, 78
 - server, 77, 79
- country code, 34
- credit, 35
- CSMA/CD, 24–25

- data confidentiality, 14
- data integrity, 14
- DCOM, 73
- DECNET, 8
- despatcher, 63
- domain, 34

- Domain Name Service (DNS), 34
- Dynamic Host Configuration Protocol (DHCP), 32
- Dynamic Invocation Interface (DII), 74
- dynamically allocated port, 34, 71

- end system, 3
- entity, 4
- Ethernet, 24–25
 - gigabit, 24
 - shared, 25
 - switched, 25
- exactly-once semantics, 62
- expedited data, 13
- Extensible Markup Language (XML), 83

- filter, 22
- firewall, 22
- fragmentation, 17

- GRID, 96

- header, 17
- HTTP, 50–54
 - cache control, 52
 - compression, 52
 - credentials, 53
 - GET method, 53, 54
 - media type, 52
 - method, 50, 52
 - OPTIONS method, 54
 - request, 50, 83
 - response, 50, 83
- hyperlink, 50
- Hypertext Transfer Protocol (HTTP), 50–54
- HypertextMarkup Language (HTML), 50

- IANA, 34, 38
- implementation repository, 74
- inheritance model, 77
- integrity, 14
- interface, 75
- Interface Definition Language (IDL), 64, 75
- interface repository, 74

- International Organization for Standardisation (ISO), 20
- International Telecommunications Union (ITU-T), 20
- Internet, 8
 - protocol, 8
- Internet Application Layer, 37–38
- Internet Message Access Protocol (IMAP), 38
- Internet Protocol (IP), 28–34
- IPv4, 30
- IPv6, 30
- ISO, 20
- ITU-T, 20
- Java
 - codebase, 71
 - IDL, 75, 76
 - remote exception, 66
 - remote interface, 66, 68
 - remote object, 66, 69
 - RMI, 66–73
 - security manager, 68
 - security policy, 71, 72
- jitter, 16
- LAN, 14
 - layer, 4
 - layered architecture, 4–10
 - link, 50
- Local Area Network (LAN), 3, 14
- Logical Link Control (LLC), 23
- mailbox, 38
- mailer, 38
- marshalling, 63
- maybe semantics, 63
- MD5, 54
- Medium Access Control (MAC), 23
- method
 - accept, 58
 - HTTP, 50, 52
- Metropolitan Area Network (MAN), 3
- MIME, 42–48
 - body, 44
 - composite type, 44, 45
 - discrete type, 44, 45
 - entity, 44
 - header, 44
 - subtype, 44, 45
 - type, 44, 45, 52
- multi-tier model, 95
- multiplexing, 13
- (N)-entity, 4
- (N)-protocol, 4
- name, 34
- naming authority, 34
- naming domain, 34
- netmask, 32
- network class, 32
- node, 3
 - communication, 3
- non-repudiation, 14
- object, 63
- object adapter, 74
- Object Management Group (OMG), 73
- Object Request Broker (ORB), 73
- Open Systems Interconnection (OSI), 4
- OSI Reference Model, 4–8
- packing, 17
- path, 47
- PDU format, 19
- port, 34, 37, 47
 - assigned, 34
 - dynamically allocated, 34, 71
 - registered, 34
- portable implementation, 73
- Portable Object Adapter (POA), 74, 77
- Post Office Protocol (POP), 38
- Private Network (PN), 32
- protocol, 4, 10
- Protocol Control Information (PCI), 16–18
- Protocol Data Unit (PDU), 16
- proxy
 - object, 65
- Quality of Service (QoS), 15–16
- query, 47
- reassembly, 17

- receive window, 35
- registered port, 34
- registry, 64, 68, 71, 89, 91
- remote interface, 66, 68
- Remote Method Invocation (RMI), 66–73
- remote object, 65, 66, 71
- Remote Object Invocation (ROI), 65–73
- Remote Procedure Call (RPC), 62–64
- Residual Error Rate (RER), 12
- resource, 47
- RFC, 95
- RMI-IIOP, 82
- rmic, 71
- ROI, 65–73
- router, 21
- RPC, 62–64
 - call semantics, 62
 - idempotent, 63
 - marshalling, 63
 - stub, 63
- Rules of procedure, 19

- scheme, 47
- sec:intro, 2
- secure service, 14
- security, 14
- security manager, 68
- security policy, 71, 72
- segmentation, 17
- sequence number, 35
- sequence preservation, 14
- serialise, 66
- servant, 77
- server, 39, 63, 77
- server script, 52
- service, 4, 10–16
 - authenticated, 14
 - block oriented, 11
 - broadcast, 13
 - confidential, 14
 - connection-mode, 12
 - connectionless-mode, 12
 - duplex, 13
 - integrity of, 14
 - inverse broadcast, 13
 - message oriented, 11
 - multi-peer, 13
 - multicast, 13
 - multiplex, 13
 - non-repudiating, 14
 - peer-to-peer, 13
 - secure, 14
 - sequence preserving, 10
 - simplex, 13
 - stream oriented, 11
 - two-peer, 13
- Service Data Unit (SDU), 17
- Simple Mail Transfer Protocol (SMTP), 38–47
- Simple Object Access Protocol (SOAP), 82–95
- skeleton, 74
- SMTP
 - command, 39–40
 - extensions, 42
 - reply, 39, 42–43
- SNA, 8
- SOAP, 82–95
 - Apache, 89
 - body, 83
 - body entry, 83
 - compound type, 86
 - envelope, 83
 - faultcode, 86
 - header, 83
 - header entry, 83
 - message, 83
 - request, 83
 - response, 83
 - simple type, 86
 - type, 86–89
- socket, 55
 - BSD, 55
 - Java client, 55–58
 - Java server, 58–61
- software component, 73
- stream, 11
- stream filter, 57
- stub, 63, 65, 71, 74
- stub compiler, 71
- Sun RPC, 64

- switch, 25
- thread, 61, 64
- timeout, 58
- token bus, 14
- token ring, 14
- trader, 64
- trailer, 17
- Transmission Control Protocol (TCP), 34–37
- type
 - serialisable, 66
- Uniform Resource Identifier (URI), 47–49
- Universal Description, Discovery and Integration (UDDI), 91
- urgent data, 13
- URI, 47–49, 66, 68
 - path, 47
 - port, 47
 - query, 47
 - scheme, 47
- User Datagram Protocol (UDP), 37
- Web resource, 47
- Web service, 82–83, 91–95
 - publication, 89, 91
 - registry, 89, 91
- Web Service Description Language (WSDL), 91
- Wide Area Network (WAN), 3
- window, 35
- window protocol, 35
- Wireless LAN, 26–28
- World Wide Web, 47
- XML
 - array, 88
 - datatype, 86–89
 - derived type, 89
 - document, 83
 - element, 83
 - enumeration type, 88
 - namespace, 85
 - struct, 88
 - ur-type, 89