



## **Recommended assessment framework, method and characterisation and normalisation factors for ecosystem impacts of eutrophying emissions: phase 3 (report, model and factors)**

**Azevedo, L.B.; Cosme, Nuno Miguel Dias; Hauschild, Michael Zwicky; Henderson, A.D.; Huijbregts, M.A.J.; Jolliet, Olivier ; Larsen, Henrik Fred; van Zelm, R.**

*Publication date:*  
2013

*Document Version*  
Publisher's PDF, also known as Version of record

[Link back to DTU Orbit](#)

*Citation (APA):*  
Azevedo, L. B., Cosme, N. M. D., Hauschild, M. Z., Henderson, A. D., Huijbregts, M. A. J., Jolliet, O., Larsen, H. F., & van Zelm, R. (2013). *Recommended assessment framework, method and characterisation and normalisation factors for ecosystem impacts of eutrophying emissions: phase 3 (report, model and factors)*.

---

### **General rights**

Copyright and moral rights for the publications made accessible in the public portal are retained by the authors and/or other copyright owners and it is a condition of accessing publications that users recognise and abide by the legal requirements associated with these rights.

- Users may download and print one copy of any publication from the public portal for the purpose of private study or research.
- You may not further distribute the material or use it for any profit-making activity or commercial gain
- You may freely distribute the URL identifying the publication in the public portal

If you believe that this document breaches copyright please contact us providing details, and we will remove access to the work immediately and investigate your claim.

## DELIVERABLE FRONTPAGE

*Project number:* 243827 FP7-ENV-2009-1

*Project acronym:* LC-IMPACT

*Project title:* Development and application of environmental Life Cycle Impact assessment Methods for imProved sustAinability Characterisation of Technologies.

*Deliverable number:* D3.7 (T3.1: Aquatic eutrophication)

*Deliverable name:* Recommended assessment framework, method and characterisation and normalisation factors for ecosystem impacts of eutrophying emissions: phase 3 (report, model and factors)

*Version:* Final

*WP number:* 3

*Lead beneficiary:* DTU

*Nature:* R + O <sup>1</sup>

*Dissemination level:* PU <sup>2</sup>

*Delivery date:* Month 41

*Actual delivery date:* 01/05/2013

*Authors:* Azevedo LB, Cosme N, Hauschild MZ, Henderson AD, Huijbregts MAJ, Jolliet O, Larsen HF, van Zelm R

*Comments:*

---

<sup>1</sup> Please indicate the nature of the deliverable using one of the following codes: **R** = Report, **P** = Prototype, **D** = Demonstrator, **O** = Other

<sup>2</sup> Please indicate the dissemination level using one of the following codes: **PU** = Public, **PP** = Restricted to other programme participants (incl. the Commission Services), **RE** = Restricted to a group specified by the consortium (incl. the Commission Services), **CO** = Confidential, only for members of the consortium (incl. the Commission Services)

## List of abbreviations

### *Used for freshwater eutrophication:*

AEF	Average effect factor
CF	Characterisation factor
cPNOF	Calculated potentially not occurring fraction
EF	Effect factor
ePNOF	Empirical potentially not occurring fraction
FEOW	Freshwater ecoregions of the world
FF	fate factor
LCIA	Life cycle impact assessment
LEF	Linear effect factor
MEF	Marginal effect factor
MHT	Major freshwater habitat types
P	Phosphorus
PNOF	Potentially not occurring fraction
SR	Species richness
TP	Total phosphorus

### *Used for marine eutrophication:*

BOD	Biological Oxygen Demand
BGE	Bacterial Growth Efficiency
CF	Characterisation Factor
DO	Dissolved Oxygen
DO	Dissolved Oxygen
EE	Effect Factor
FF	Fate Factor
HC50	Hazard Concentration with 50% of the population exposed above its EC50
LC50	Lethal Concentration with effect on 50% of the population
LCA	Life Cycle Assessment
LCIA	Life Cycle Impact Assessment
LME	Large Marine Ecosystem
LT <sub>50</sub>	Median Lethal Time required to 50% of population to die
N	Nitrogen
NIE	Nitrogen Incorporation Efficiency
NOEC	No-Observed-Effect Concentration
PAF	Potentially Affected Fraction of species
SLC <sub>50</sub>	Sub-Lethal Concentration with effect on 50% of the population
SSD	Species Sensitivity Distribution
VCC	Volume Correction Coefficient
XF	Exposure Factor

## Table of contents

<b>DELIVERABLE FRONTPAGE</b> .....	<b>1</b>
<b>List of abbreviations</b> .....	<b>2</b>
<b>Table of contents</b> .....	<b>3</b>
<b>1. EXECUTIVE SUMMARY</b> .....	<b>6</b>
1.1 Overall summary .....	6
1.2 The environmental mechanism of freshwater eutrophication .....	7
1.2.1 Spatial aggregation of CF .....	8
1.2.2 Spatial aggregation of normalization factors.....	8
1.2.3 Species and freshwater type aggregation .....	8
1.3 Main findings of the freshwater eutrophication method .....	8
1.4 The environmental mechanism of marine eutrophication .....	9
1.5 Main findings of the marine eutrophication method .....	10
1.6 References.....	10
<b>2. SPATIALLY-EXPLICIT CHARACTERISATION FACTORS FOR FRESHWATER EUTROPHICATION ON A GLOBAL SCALE</b> .....	<b>11</b>
Abstract .....	11
2.1 Introduction .....	12
2.2 Material and methods.....	12
2.2.1 Characterisation models.....	12
2.2.2 Fate factors .....	13
2.2.3 Effect factors.....	13
2.2.4 Input data .....	14
2.2.5 Normalization .....	15
2.3 Results .....	18
2.4 Discussion.....	18
2.4.1 Differences between characterisation factor types .....	18
2.4.2 Effect factor uncertainties .....	19
2.4.3 Relevance, applicability and further research recommendations .....	20
2.4.4 Concluding remarks .....	20
2.5 Published peer-reviewed deliverables.....	21
2.6 Tables and figures .....	22
2.7 Supporting information.....	26
Appendix 2-I: Allocation of grids to their respective region .....	26
Appendix 2-II: Environmental concentration data .....	39
Appendix 2-III: Comparison between characterisation factors types for lake heterotrophs and stream autotrophs and heterotrophs .....	42
Appendix 2-IV: Grid, country, continent, and world characterisation factors .....	53
Appendix 2-V: Grid, country, continent, and world emission estimates .....	54
Appendix 2-VI: Grid, country, continent, and world normalization factors .....	55

2.8	References for freshwater eutrophication.....	56
<b>3.</b>	<b>SPATIALLY-EXPLICIT CHARACTERISATION FACTORS FOR MARINE EUTROPHICATION.....</b>	<b>58</b>
	Abstract .....	58
3.1	Introduction .....	59
3.1.1	Background .....	59
3.1.2	Eutrophication as a function of nutrients or organic matter enrichment? .....	60
3.1.3	Marine productivity and eutrophication .....	60
3.1.4	Organic loading.....	61
3.1.5	Nutrients enrichment .....	62
3.1.6	Nitrogen cycle .....	62
3.1.7	Effects of nitrogen in marine waters .....	63
3.1.8	Data search .....	65
3.1.9	Research goals .....	66
3.2	Methodology.....	66
3.2.1	Framework.....	66
3.2.2	Unit areas for spatial differentiation .....	68
3.2.3	Fate Factors (FF) and the fate model.....	69
3.2.4	Exposure Factors (XF) .....	72
3.2.5	Effect Factors (EF) .....	76
3.2.6	Normalisation .....	79
3.2.7	Sensitivity analysis .....	79
3.2.8	Uncertainty analysis.....	80
3.3	Results.....	81
3.3.1	Fate Factors (FF).....	81
3.3.2	Exposure Factors (XF) .....	81
3.3.3	Effect Factors (EF) .....	81
3.3.4	Characterisation Factors (CF).....	81
3.3.5	Normalization References (NR) .....	82
3.3.6	Sensitivity test.....	82
3.3.7	Uncertainty estimation .....	83
3.4	Discussion.....	84
3.4.1	Estimations and modelling .....	84
3.4.2	The biogeographical classification system.....	85
3.4.3	Issues concerning biological data .....	85
3.4.4	Comparison with existing and recommended methods.....	85
3.4.5	Analysis of the spatial differentiation of the Characterisation Factors (CF) .....	86
3.4.6	Normalisation References (NR) .....	88
3.4.7	Environmental relevance, completeness, and consistency .....	89
3.4.8	Sensitivity and uncertainty .....	89
3.5	Final considerations .....	93
3.6	References for the Marine Eutrophication chapter .....	93

3.7	Appendices.....	99
	Appendix 3-I. Large Marine Ecosystems (LMEs) .....	99
	Appendix 3-II: Climate Zones .....	100
	Appendix 3-III. Nitrogen losses in the marine compartment.....	101
	Appendix 3-IV: Nitrogen conversion in the photic zone .....	106
	Appendix 3-V: Testing normality of species sensitivity data: goodness-of-fit test .....	107
	Appendix 3-VI: Generation of Species Sensitivity Distributions (SSD) .....	109
	Appendix 3-VII: Species Sensitivity Distribution (SSD) curves.....	111
	Appendix 3-VIII: Residence time variation range.....	114
	Appendix 3-IX: Fate.....	115
	Appendix 3-X: Exposure .....	118
	Appendix 3-XI: Effect.....	122
	Appendix 3-XII: Characterisation Factors.....	123
	Appendix 3-XIII: Aggregation of Characterisation Factors .....	142
	Appendix 3-XIV: Normalisation .....	144
	Appendix 3-XV: Uncertainty quantification .....	149

# Recommended assessment framework, method and characterisation and normalisation factors for ecosystem impacts of eutrophying emissions

## 1. EXECUTIVE SUMMARY

### 1.1 Overall summary

The eutrophication process of aquatic ecosystems, either marine or freshwater, is characterized by an excessive growth and accumulation of algae and other aquatic plants in response to an increased input of nutrients (Seppälä et al. 2004). Once the plant nutrients, mainly nitrogen (N) and phosphorous (P) are available to assimilation and growth, the excessive biomass produced can decrease the water quality and bring undesirable effects to resident biological communities (OSPAR 2008).

Nutrients availability acts as a limiting factor in freshwater, estuarine and marine ecological systems. In principle, the concept of 'limiting nutrient' states that one nutrient is limiting the growth (size and number) of a resident population and that all other nutrients are available in excess. If an additional amount of the limiting nutrient is introduced into the system, this will promote an increase in growth. On the other hand, an introduction of any of the other nutrients will have no reflection on growth as they are already in excess (Finnveden & Potting 1999).

Freshwater systems are often limited by phosphorous, marine systems by nitrogen, and estuarine systems by either or both. For modelling purposes the 'limiting nutrient' concept is a simplification, as exceptions can be found, other nutrients can be limiting in specific conditions, variations along the annual seasons, and different species can show different requirements (Finnveden & Potting 1999).

Excessive nutrients enrichment is likely to stimulate an undesirable growth of phytoplankton and macroalgae. The senescence and decay of this plant biomass will use a large amount of oxygen during bacterial degradation, especially in bottom waters, where degradation is more intense and reaeration less effective.

Life Cycle Assessment is an environmental assessment tool used to address and evaluate the exchanges between the technosphere and the environment, and thus the resulting potential impacts of a product or service from 'cradle to grave', i.e. the entire life cycle.

Life Cycle Impact Assessment (LCIA) is a crucial phase because it quantifies the potential for environmental impacts by an evaluation of impact scores ( $S_i$ ) for each impact category that result from the multiplication of the emission inventories by the specific characterisation factor (CF). The evaluation can take place either at the midpoint or endpoint level: midpoints (e.g. amount of nutrients in the water) correspond to early links in the cause-effect chain that potentially evolve into individual impacts, or endpoints (e.g. loss of biodiversity) (Bare et al. 2000).

Data from the inventory (i.e. emitted quantities) are thus converted into impact category indicators by application of the CFs.

Even though aquatic eutrophication has worldwide repercussions (Björklund *et al.*, 2009), the currently recommended method in the context of LCIA is only available for European emissions (Struijs *et al.*, 2009; Struijs *et al.*, 2011).

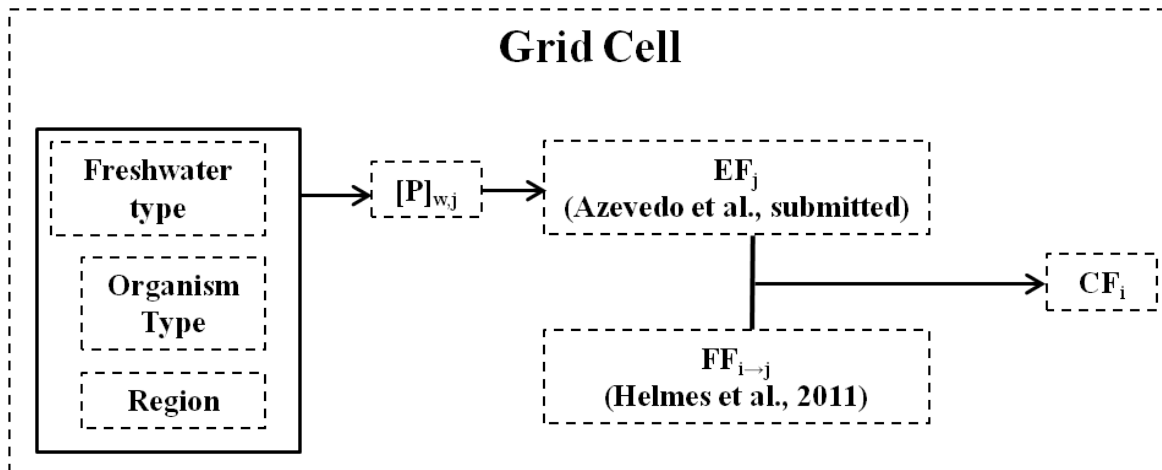
Here, we developed spatially-explicit global CFs for freshwater eutrophication impacts related to phosphorus emissions. Differences in hydrological, climatic, and ecological processes across regions at a 0.5° x 0.5° spatial resolution were taken into account in the CF development.

On its turn, marine eutrophication is still lacking a sound methodology in LCIA to link the midpoint and endpoint indicators in an overall model to assess the potential impact of the over-enrichment of marine ecosystems by nitrogen.

Here, a new endpoint model with global applicability is presented to account for the potential impacts of nitrogen loadings to coastal marine waters, translated into oxygen consumption and in effect to resident biota, at a country-to-receiving ecosystem resolution scale.

## 1.2 The environmental mechanism of freshwater eutrophication

The fate factor includes three pathways by which phosphorus can be transported downstream. These are: retention, advection, and water use (Fig. 1). Retention occurs due to biological uptake of phosphorus and adsorption to suspended particles. Advection and water use are the processes of downstream transport and water withdraw from freshwaters. Effect factors were separately derived for four regions [(sub)tropical, xeric, temperate, and cold], two species groups (which perform and do not perform photosynthesis, respectively), and two freshwater types (lakes and streams). The transport mechanism (described by fate factors) and the ecological impact (described by the effect factors) are then combined to derive spatially-explicit characterization factors (CF<sub>*i*</sub>) in a given world grid *i* (Figure 1.1).



**Figure 1.1:** Main pathways by which phosphorus is transported downstream and ecological components (region and species group and freshwater type) considered in the endpoint characterization factors. The concentration of phosphorus in freshwater type *w* in grid *j*, the effect factor in grid *j*, the net transport of phosphorus from emitting grid *i* to receiving grid *j*, and the characterization factor of emitting grid *i* are described as, respectively,  $[P]_{w,j}$ ,  $LEF_j$ ,  $FF_{i \rightarrow j}$ , and  $CF_i$ .

The characterization factors are derived by summing the individual products of the partial fate factor from emitting grid *i* in grid *j* ( $PF_{i \rightarrow j}$ ) with the linear effect factor type  $LEF_{j,s,w}$  in grid *j* of species group *s* (autotrophs or heterotrophs) in freshwater type *w* (lake or stream) as



$$CF_{i,s,w} = \sum_j (PFF_{i \rightarrow j} \cdot LEF_{j,s,w}) \quad (1)$$

The effect factors  $LEF_{j,s,w}$  depend upon the species group  $s$ , freshwater type  $w$ , and region of the receiving grid  $j$  [(sub)tropical, xeric, temperate, or cold].

### 1.2.1 Spatial aggregation of CF

We calculated region-specific (i.e. country, continent, and world) CFs as the mean of CF of grids within them. Note that we also report grid-specific CFs.

### 1.2.2 Spatial aggregation of normalization factors

We estimated region-specific (i.e. country, continent, and world) emissions by summing estimates of emission across grids within each region. Finally, we calculated normalization factors per region (i.e. country, continent, and world) by multiplying the CF and the emission estimate relative to the region. Note that we also report grid-specific emission and normalization factors.

### 1.2.3 Species and freshwater type aggregation

Given that we provide up to four types of CF (based on lake autotrophs, lake heterotrophs, stream autotrophs, and stream heterotrophs), in this work we propose that they are aggregated as

$$CF_i = \sum_{j,s,w} (PFF_{i \rightarrow j} \cdot LEF_{j,s,w} \cdot v_{j,w}) \quad (2)$$

where  $v_{j,w}$  is the fraction of water volume in grid  $j$  residing in freshwater type  $w$ . The aggregation based on all four biotic endpoints, however, was only possible in temperate regions. In (sub)tropical and xeric regions, the CF is based on one biotic endpoint only (i.e. stream autotrophs and lake autotrophs, respectively). In cold regions, the CF is based on aggregating heterotrophs and autotrophs in lakes.

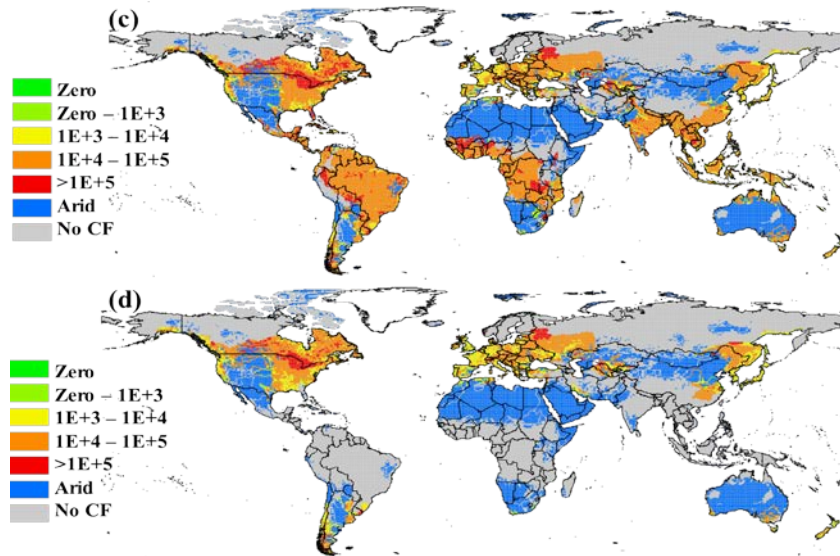
## 1.3 Main findings of the freshwater eutrophication method

We were able to provide more spatially-detailed CFs (per grid, country, and continent) than those available up to now (only European-generic CFs). However, as opposed to the current recommended method by ILCD (Struijs *et al.*, 2009), we were not able to account for the transport of phosphorus in the terrestrial compartment prior to its discharge to water bodies, e.g. via surface runoff. This means that CFs for emissions to agricultural soils are currently lacking and warrant further research. In addition, the transport of nitrogen is not considered since we assumed that nitrogen does not play a role in the damage to freshwater ecosystems.

We were also able to include ecosystem damages to lakes in addition to streams, which were the only freshwater body taken into account in the current recommended method. We also include an important taxonomic group (autotrophs) as part of the species influences by phosphorus surpluses. Furthermore, we added fish species and other invertebrates to the existing macroinvertebrate species group upon which the current recommended method is currently based.

There are, however, also constraints to the method we propose in LC-IMPACT. Although these constraints are also present in the current recommended method, it is important to emphasize

where further research efforts by LCIA should be. First, we do not further differentiate effect factors in more specific species groups, such as cyanobacteria and macrophytes with the broad species group of autotrophs. Furthermore, we do not further differentiate in the ecological variability within a given region. Third, although we are able to provide species and freshwater type aggregated endpoint CF for freshwaters outside Europe, effect factors are not available for all organisms and freshwater types (Figure 1.2). For example, we were not able to determine the effect of phosphorus in streams in the cold region but only in lakes.



**Figure 1.2:** Characterization factors (CFs) for autotrophs and heterotrophs in streams using the linear effect factor (LEFa), independent of phosphorus concentration levels. CFs for lakes are not shown. Units are given as  $\text{day} \cdot \text{kgP}^{-1} \cdot \text{m}^3$ . Note that no CFs are available for high latitude regions of the Northern Hemisphere.

#### 1.4 The environmental mechanism of marine eutrophication

The estimation of the potential impacts for marine eutrophication for use in LCIA is built on the application of Characterisation Factors (CF, unit:  $(\text{PAF})[\text{m}^3 \cdot \text{d}/\text{kgN}]$ ), defined by:

$$CF_{ij} = FF_{ij} \times XF_j \times EF_j$$

Where FF is the Fate Factor (unit: [d]) for emission route  $i$  to receiving ecosystem  $j$ , XF is the Exposure Factor (unit:  $[\text{kgO}_2/\text{kgN}]$ ) in receiving ecosystem  $j$ , and EF is the Effect Factor (unit:  $(\text{PAF})[\text{m}^3/\text{kgO}_2]$ ) in receiving ecosystem  $j$ .

The emission routes of N include “N to air”, “N to surface freshwater”, “N to groundwater” and “N to coastal marine waters”, and the receiving ecosystems considered are the Large Marine Ecosystems (LME) spatial units developed by NOAA (Sherman, 1991)

The FF estimates the N fraction exported to marine waters and the N losses in the marine compartment, thus expressing how N loadings into this compartment vary. The FF depends on the N fate in soil, the atmospheric fate, the fate in freshwater systems, and on the losses once in the marine compartment (denitrification, advection and sedimentation).

The XF expresses the conversion from nitrogen to organic matter (phytoplankton biomass) in the photic zone and to dissolved oxygen consumption in bottom waters.

The EF represents the change in the potentially affected fraction of species (PAF) in the receiving marine ecosystem due to the change in dissolved oxygen.

The marine eutrophication model framework can be seen as a combination of an environmental mechanism that governs the N fate processes and delivers the FF, and another environmental mechanism that governs the exposure from N to OM and oxygen depletion, delivering the XF. The processes that lead to the impacts on biota deliver the EF.

## 1.5 Main findings of the marine eutrophication method

The model delivers CFs for the “N to air”, “N to freshwater”, “N to groundwater”, and “N to marine coastal waters” inventory flows for 214 countries-to-LME combinations, 143 countries, 13 aggregated regions/continents, and a global default.

Sensitivity analysis shows higher contribution of Primary Production (PP) rate datasets to the resulting CFs. The uncertainty arising from choosing the correct fractions of N emissions for each of receiving ecosystems (for countries exporting to multiple receiving LMEs) and the PP rate datasets are the most significant.

The combination of sensitivity and uncertainty have been identified as key issues for improvement of the model framework, the PP rate datasets, N-export splitting rules for multiple receiving ecosystems, and the residence time in the marine compartment.

The proposed methodology covers all the processes of relevance to the marine eutrophication of N-emissions and delivers CFs at a considerably high geographic applicability, with good environmental relevance and reproducibility.

## 1.6 References

Bare JC, Hofstetter P, Pennington DW, Udo de Haes HA. 2000. Midpoints versus Endpoints: The Sacrifices and Benefits. *The International Journal of Life Cycle Assessment* 5(6): 319-326.

Björklund G, Burke J, Foster S, Rast W, Vallée D, van der Hoek W. 2009. 3rd UN World Water Development Report: Water in a Changing World (WWDR-3). Chapter 8: Impacts of water use on water systems and the environment. (ed. by Unesco), pp 432. UN World Water Assessment Programme.

Finnveden G, Potting J. 1999. Eutrophication as an Impact Category – State of the Art and Research Needs. *The International Journal of Life Cycle Assessment* 4(6): 311-314.

OSPAR. 2008. Second Integrated Report on the Eutrophication Status of the OSPAR Maritime Area. OSPAR Commission. Eutrophication Series 372/2008, 107 pp.

Seppälä J, Knuuttila S, Silvo K. 2004. Eutrophication of Aquatic Ecosystems: A New Method for Calculating the Potential Contributions of Nitrogen and Phosphorus. *International Journal of Life Cycle Assessment* 9: 90-100.

Sherman K. 1991. The Large Marine Ecosystem Concept: Research and Management Strategy for Living Marine Resources. *Ecological Applications* 1(4): 350-360.

Struijs J, Beusen A, de Zwart D, Huijbregts M. 2011. Characterization factors for inland water eutrophication at the damage level in life cycle impact assessment. *International Journal of Life Cycle Assessment*, 16, 59-64.

Struijs J, Beusen A, van Jaarsveld H, Huijbregts, MAJ. 2009. Chapter 6. ReCiPe 2008 A life cycle impact assessment method which comprises harmonised category indicators at the midpoint and the endpoint level. Report I: Characterisation factors, first edition. *Aquatic Eutrophication* (ed. by M Goedkoop, R Heijungs, MAJ Huijbregts, A De Schryver, J Struijs, R Van Zelm).

## 2. SPATIALLY-EXPLICIT CHARACTERISATION FACTORS FOR FRESHWATER EUTROPHICATION ON A GLOBAL SCALE

Ligia B. Azevedo\*<sup>1</sup>, Andrew D. Henderson<sup>2,3</sup>, Rosalie van Zelm<sup>1</sup>, Olivier Jolliet<sup>2</sup>, Mark A. J. Huijbregts<sup>1</sup>

<sup>1</sup> Department of Environmental Science, Institute for Water and Wetland Research, Radboud University Nijmegen, P.O. Box 9010, 6500 GL, Nijmegen, The Netherlands

<sup>2</sup> Department of Environmental Health Sciences, School of Public Health, University of Michigan, 1415 Washington Heights, Ann Arbor, MI 48109, USA

<sup>3</sup> Division of Epidemiology, Human Genetics and Environmental Sciences, School of Public Health, The University of Texas Health Science Center at Houston, 1200 Herman Pressler, Houston, Texas 77030, USA

\*Corresponding author:

Ligia B. Azevedo; Tel: +31 (0)243653291; Fax: +31 (0)243553450; e-mail: l.azevedo@science.ru.nl

### Abstract

This study derives spatially-explicit endpoint characterisation factors (CF) for freshwater eutrophication for phosphorus (P) on a global scale and on an European scale. The CF were derived separately for autotrophs and heterotrophs residing in lakes and streams as the change in the potentially not occurring fraction (PNOF) of species relative to a change in the emission of P. Additionally, we tested how three different effect models, i.e. linear (LEF), marginal (MEF), and average (AEF) effect factors, representing the change in the potentially not occurring fraction of species (PNOF) with changing total P levels, would affect CFs in P emitting areas of Europe. The effect models differed in respect to their assumption of linear/non-linear responses of PNOF to P increases, inclusion of an environmental target and of monitored total P levels, and their biotic endpoints (species richness of autotrophs and heterotrophs in lakes and streams). Although we successfully derived CF using the three effect factor methods for Europe, the effect factors elsewhere were limited to the linear effect factor method, which does not require the concentration of P as an input parameter. For Europe, we derived CF for the two organisms in the two freshwater types. Our results show that colder areas, i.e. of high latitude and altitude, comprising large quantities of lacustrine water bodies have higher CF due to the high sensitivity of freshwater organisms in these areas plus the long residence time of P in lakes. In Europe, CFs based on the effect models generally differed up to two orders of magnitude, with AEF-based CFs generally lower than those based on MEF and on LEF (with the exception of those based on lake autotrophs). This study points towards the deviations between current effect models currently used in life cycle impact assessment.

## 2.1 Introduction

The flow of phosphorus through the Earth's surface has increased dramatically (Liu et al., 2008). As a result, aquatic eutrophication is currently the primary water quality issue worldwide (Björklund et al., 2009). In freshwaters, algal growth is mainly attributed to phosphorus (P) but shifts in taxa richness as a result of increasing P levels may also occur (Schindler, 1977; Struijs et al., 2011b).

Given that the relationship between species richness and P concentrations differ across world's regions (Amarasinghe and Welcomme, 2002; Azevedo et al., in press), it is important that spatial specificity is taken into account in estimating the ecological effects of eutrophication. Currently, spatially-explicit models of the ultimate effects of emissions of P to species richness in freshwaters are not available on large spatial scales (i.e. continent or worldwide).

The goal of this study was to develop spatial-explicit quantitative relationships between the emission of P and relative species richness losses in inland freshwaters on the global scale, described in life-cycle impact assessment (LCIA) by the use of characterisation factors (Udo de Haes et al., 2002). Endpoint CF are available for European freshwaters yet they are site-generic and do not address potential differences across regions exposed to nutrient increases (Payet, 2006; Struijs et al., 2011a). This step is crucial to understanding the extent of the potential effects of P discharges to freshwater biodiversity and to identifying which world's regions may trigger the highest impacts via eutrophication. For that reason, it is important to consider site-specificity in LCIA (Seppälä et al., 2004).

Given that characterisation factors can be determined in different ways, their results may depend on which method was employed. For example, the relationship between the levels of a stressor and the ecological effects may be considered to be linear or not (Pennington et al., 2004). In addition, the target levels of a stressor may have been specified or not (Huijbregts et al., 2011); or the actual level of a stressor in the environment may be known or not.

## 2.2 Material and methods

### 2.2.1 Characterisation models

We derived endpoint CFs ( $\text{day} \cdot \text{m}^3 \cdot \text{kg}^{-1}$ ) for four different biotic endpoints: autotrophs in lakes, autotrophs in streams, heterotrophs in lakes and heterotrophs in streams. The CFs were derived for total phosphorus (TP) with a  $0.5^\circ \times 0.5^\circ$  grid resolution as

$$CF_{i,s,w} = \sum_j (FF_{i \rightarrow j} \cdot EF_{j,s,w}) \quad (1)$$

where  $CF_{i,s,w}$  is the characterisation factor of emitting grid  $i$  for species group  $s$  (autotrophs or heterotrophs) in freshwater type  $w$  (lake or stream),  $FF_{i \rightarrow j}$  (day) is the partial fate factor for grid  $i$  to downstream grid  $j$  and  $EF_{j,s,w}$  is the effect factor for species group  $s$  in freshwater type  $w$  (lake or stream) in grid  $j$  ( $\text{m}^3 \cdot \text{kg}^{-1}$ ). Hereafter, all references to P stand for the total P (TP), which is the summation of dissolved and particulate fractions of organic and inorganic P fractions.

Within LC-IMPACT, we also derived midpoint CFs (days), described by Helmes et al. (2012) as

$$CF_i = \sum_j (FF_{i \rightarrow j})$$

### 2.2.2 Fate factors

The partial fate factors ( $FF_{i \rightarrow j}$ , unit: day) were derived by Helmes et al. (2012) and they describe the transport of P emitted to water compartment as

$$FF_{i \rightarrow j} = f_{i \rightarrow j} \cdot \tau_j \quad (2)$$

where  $f_{i \rightarrow j}$  is the fraction of P transported from emitting grid  $i$  to downstream grid  $j$  and  $\tau_j$  is the persistence of P in grid cell  $j$  (days). The fraction of P transported from  $i$  to  $j$  was defined by Helmes et al. (2012) as

$$f_{i \rightarrow j} = \prod_{l=i}^{j-1} \frac{k_{adv,l}}{k_{adv,l} + k_{ret,l} + k_{use,l}} \quad (3)$$

and

$$\tau_j = \frac{1}{k_{adv,l} + k_{ret,l} + k_{use,l}} \quad (4)$$

where advection ( $k_{adv,l}$ ) is the rates at which water volume in rivers and lakes is transported to a downstream grid, retention ( $k_{ret,l}$ ) is the rate of biotic uptake and particle adsorption or sedimentation, and water use ( $k_{use,l}$ ) is the withdraw rate of human water consumption (Helmes et al., 2012). The transport of P from an emitting grid  $i$  to  $j$  could have occurred into and through one or both freshwater types  $w$  (lakes or streams) within a given grid. A more detailed description of the derivation of  $FF_{i \rightarrow j}$  is described by Helmes et al. (2012).

### 2.2.3 Effect factors

Three types of effect factors were developed based on observational field observations described as the potentially not occurring fraction (PNOF, dimensionless) (van Zelm et al., 2007) of freshwater species and total P (TP) concentrations. PNOF – TP log-logistic relationships are reported as

$$PNOF_{j,s,w} = 1 - RSR_{j,s,w} \quad (6)$$

and

$$RSR_{j,s,w} = \frac{1}{1 + e^{-\left(\frac{\log_{10} C_{j,s,w} - \alpha_{j,s,w}}{\beta_{j,s,w}}\right)}} \quad (7)$$

where  $RSR_{j,s,w}$  is the relative species richness of group  $s$  in freshwater type  $w$  in grid  $j$ ;  $C_{j,w}$  is the TP concentration in freshwater  $w$  in grid  $j$  ( $\text{kgP} \cdot \text{m}^{-3}$ ),  $\alpha$  is the  $^{10}\log$  concentration of TP at which PNOF equals 0.5,  $\beta$  is the slope of the log-logistic function. RSR is described for the two freshwater types (lakes and streams), two species groups (autotrophs and heterotrophs), in four different world's regions [cold, temperate, (sub)tropical, and xeric] by Azevedo et al. (in press). We



allocated each region to its respective grid  $j$  using their geographical location in ArcGIS (see Appendix 2-I of the Supporting Information for the description of the allocation procedure).

The linear  $EF$  model, hereafter named  $LEF$  (unit:  $\text{m}^3 \cdot \text{kgP}^{-1}$ ), assumes a linear change of PNOF with increasing TP levels. It is commonly used in ecotoxicology (Rosenbaum et al., 2008) and it represents the average effect between the TP concentration at which PNOF equals to 0.5 and a TP target level equal to zero. It is described as

$$LEF_{j,s,w} = \frac{\Delta PNOF_{j,s,w}}{\Delta C_{j,w}} = \frac{(0.5-0)}{(10^{\alpha_{j,s,w}}-0)} \quad (8)$$

where  $10^{\alpha_{j,s,w}}$  is the TP concentration that affects 50% of the species  $s$  in freshwater  $w$  in grid  $j$  ( $\text{kg P} \cdot \text{m}^{-3}$ ).

The marginal effect factor model, hereafter named  $MEF$  ( $\text{m}^3 \cdot \text{kgP}^{-1}$ ), is the change in PNOF with a marginal increase in TP in  $C_{j,w}$  ( $\text{kgP} \cdot \text{m}^{-3}$ ) (Van de Meent and Huijbregts, 2005). It is described as

$$MEF_{j,s,w} = \frac{\partial PNOF_{j,s,w}}{\partial C_{w,j}} = PNOF_{j,s,w} \cdot (1 - PNOF_{j,s,w}) \frac{1}{\frac{C_{j,w}}{10^{\alpha_{j,s,w}}} \beta_{j,s,w} \cdot \ln(10)} \cdot \frac{1}{10^{\alpha_{j,s,w}}} \quad (9)$$

The average EF,  $AEF$  ( $\text{m}^3 \cdot \text{kgP}^{-1}$ ), assumes a linear change in PNOF with increasing TP as does  $LEF$ . However, as opposed to  $LEF$ , where the default concentration in the environment is  $10^{\alpha_{j,s,w}}$ ,  $AEF$  employs the actual concentration of TP in grid  $j$  (Huijbregts et al., 2011) to estimate the average distance between PNOF at  $C_{j,w}$  and at the TP target level. It is described as

$$AEF_{j,s,w} = \frac{\Delta PNOF_{j,s,w}}{\Delta C_{j,w}} = \frac{(PNOF_{j,s,w}-0)}{(C_{j,w}-0)} \quad (10)$$

#### 2.2.4 Input data

The input data for the fate factors necessary to compute the  $FF_{i \rightarrow j}$ , which include water use, water advection, and phosphorus retention rates, are described in detail by Helmes et al. (2012). The input parameters for the  $EF$  are the log-logistic regression coefficients  $\alpha_{j,s,w}$  and  $\beta_{j,s,w}$  and TP levels  $C_{j,w}$  and they are described below.

We allocated each region, i.e. cold, temperate, xeric, and (sub)tropical, to its respective grid  $j$ . This classification of regions was based on the work by Azevedo and colleagues (in press) (see Appendix 2-I of the Supporting Information for the description of the allocation procedure). The input parameters  $\alpha$  and  $\beta$  relative to species group  $s$  in freshwater  $w$  in each region are shown in Table 2.1. Grid-specific EFs were not computed in case log-logistic regression parameters ( $\alpha$  and  $\beta$ ) were not available for the organism group in the given freshwater type and region. That was the case for autotrophs in (sub)tropical lakes and in xeric and cold streams and heterotrophs in (sub)tropical and xeric lakes and in (sub)tropical, xeric, and cold streams.

For the calculation of the CFs based on  $MEF$  and the  $AEF$ , mean TP concentrations of lakes and streams were used as the concentration in freshwater  $w$  in grid  $j$  ( $C_{j,w}$ ). For that, we obtained the annual mean TP concentration data measured at lake and stream monitoring stations reported by the European Environment Agency (EEA), see Appendix 2-II. Grid-specific  $C_{j,w}$  are shown in Figure 2.5 (Appendix 2-II).

We compared how  $CF_{i,s,w}$  results across the three types of effect factors ( $LEF$ ,  $MEF$ , and  $AEF$ ) using spearman correlation. We used the ratio between  $CF_{i,s,w}$  results to compare the relative difference between the EF types.

### 2.2.5 Normalization

The CFs described above relate to the fraction of P that is discharged into the water compartment hence the transport of P in the terrestrial compartment, i.e. before P is discharged to water bodies, is not taken into account in the characterization model (Eq. 1). Of the two emission sources contributing to freshwater eutrophication (i.e. point and non-point), the fate of P in the terrestrial compartment is relevant for non-point sources, which can be further divided into manure and industrial agricultural fertilizers. In the following, we describe how the transport of P within the soil compartment can be included in order to derive normalization scores (NS) for non-point sources. In addition, we describe the methodology and the data employed to derive NS for urban wastewater plants and manure and synthetic fertilizers.

#### **Emission data - Point sources**

We calculated emissions from sewage treatment plants to the water compartment ( $E_{Sew}$ ,  $\text{kgP} \cdot \text{day}^{-1}$ ) for the year 2000 for three different urban wastewater sources, i.e. human sewage and laundry and dishwasher detergent (Van Drecht et al., 2009) in each grid ( $0.5^\circ \times 0.5^\circ$  spatial resolution).  $E_{Sew}$  can be described as

$$E_{Sew} = E_{Hum} + E_{Det} + E_{Dish} \quad (11)$$

The emissions from human waste ( $E_{Hum}$ ), laundry detergent ( $E_{Det}$ ), and dishwasher detergent ( $E_{Dish}$ ),  $\text{kgP} \cdot \text{day}^{-1}$ , depend on the fraction of the population that is connected to a wastewater treatment plant ( $D$ , dimensionless), efficiency of P removal rate at the wastewater treatment plant ( $R$ , dimensionless), the load of sewage entering the treatment plant, i.e.  $S_{Hum}$ ,  $S_{Det}$ , and  $S_{Dish}$  ( $\text{kgP} \cdot \text{person}^{-1} \cdot \text{day}^{-1}$ ), the number of inhabitants in the grid ( $Pop$ ), among other factors (Van Drecht et al., 2009). They can be individually calculated as

$$E_{Hum} = \left( \frac{S_{Hum}}{D} \right) \cdot (1 - R) \cdot Pop \quad (12)$$

for human sewage emissions

$$E_{Det} = \left( \frac{S_{Det}}{D} \right) \cdot (1 - R) \cdot Pop \quad (13)$$

for laundry detergent and

$$E_{Dish} = S_{Dish} \cdot (1 - R) \cdot Pop \quad (14)$$

for dishwasher detergent.



Grid-specific population count data (Pop, unit: person) was obtained with the CIESIN and CIAT (2005) raster dataset for the year 2000. We used the spatial analyst tool in ArcGIS to sum the UN-adjusted 2.5'-resolution raster dataset to acquire 0.5° x 0.5° grid-specific Pop data.

Since van Drecht et al. (2009) report country-specific emissions, we employed the UN-adjusted 2.5'-resolution population density data for the year 2000 (CIESIN and CIAT 2005) to weight the emission sources across grids within each individual country and to obtain grid-specific emission data from the dataset from van Drecht et al. (2009). Thus, we assume that emissions of P to the water compartment from sewage treatment plants occur proportionally to the density of the population of a country.

### **Emission data - Non-point sources**

The emission of manure and synthetic fertilizer to soil ( $\text{kgP} \cdot \text{day}^{-1}$ ) is given as

$$E_{Fert,soil} = E_{Man} + E_{fert} \quad (15)$$

In the case of non-point emissions of P applied into soil (via manure and synthetic fertilizer applications, unit:  $\text{kgP} \cdot \text{day}^{-1}$ ), we should estimate the fraction of P which is lost from the soil into the water compartment. The fate factor  $SF$  (dimensionless) represents the fraction of P emitted from non-point source (i.e. manure or synthetic fertilizer) from the terrestrial to the freshwater compartments. Here, we consider  $SF$  equals to 0.1 (Bouwman et al., 2009) and it has been recently used as a default global transfer fraction elsewhere, i.e. Sattari (2012). A  $SF$  equal to 0.1 implies that 10% of the P fertilizer applied into agricultural soils is lost to freshwater bodies while the remaining fraction can be either taken up by crops as nutrient or retained in the soil compartment after adsorption to soil particles. As opposed to nitrogen, P does not have a relevant fraction that is transported via the atmospheric compartment. We assume the lost of P from the terrestrial to the freshwater compartment occurs immediately after its application as fertilizer. Thus, the emission from the two fertilizer types to water can be given as

$$E_{Fert,water} = SF \cdot E_{Fert,soil} \quad (16)$$

We collected data on synthetic P fertilizer consumption ( $\text{kgP}_2\text{O}_5 \text{ yr}^{-1}$ ) in 2010 from the FAOSTAT database (<http://faostat.fao.org>) on March 12<sup>th</sup>, 2013. We converted the FAO data from  $\text{kgP}$  as  $\text{P}_2\text{O}_5$  (containing 43.7% in atomic weight of P) to  $\text{kgP}$ . We here assume that all the consumed synthetic P fertilizer in 2010 was emitted to soil ( $E_{NP}$ ,  $\text{kgP} \cdot \text{yr}^{-1}$ ) in the same year. Similarly to van Drecht et al. (2009), the FAO does not report consumption per grid but per country. Hence, we calculated the relative contribution of synthetic fertilizer consumption across grids within each individual country by employing a dataset of 0.5°-specific yearly synthetic P fertilizer application rates (Potter et al. 2011).

For manure fertilizers, we employed the 0.5°-specific yearly manure P fertilizer application rates (Pottery et al. 2011), relative to the period of 1994 to 2001 ( $\text{kgP} \cdot \text{ha}^{-1}$ ). We converted the unit of the application rate from  $\text{kgP} \cdot \text{ha}^{-1} \cdot \text{yr}^{-1}$  to  $\text{kgP}^{-1} \cdot \text{day}^{-1}$  in a given grid using the relationship of 0.5° equal to 1.852 km.

**Normalization scores**

Not weighted by inhabitant

Non-weighted grid-specific normalization scores (NS, unit:  $m^3$ ) for the three types of point sources of P are described as:

$$NS_{Non-weight} = (E_{Sew} + E_{Fert,water}) \cdot CF_{s,w} \tag{17}$$

where  $CF_{s,w}$  ( $day \cdot m^3 \cdot kg^{-1}$ ) is the average of the available linear effect factor (LEF) based characterization factors for species group  $s$  in freshwater type  $w$  in a given grid. The number of available CFs in a grid can be one, i.e. in (sub)tropical and xeric grids, two, i.e. in cold grids, or four, i.e. in temperate grids (Table 2.2). In this study, we report  $CF_{s,w}$  based on three effect factor types ( $LEF$ ,  $MEF$ , and  $AEF$ ) and for four biotic endpoints (autotrophs and heterotrophs in lakes and streams). For individual life cycle impact assessments on a global scale, we recommend the use of the CF based on the linear effect factor  $LEF$  since it is the only of the three effect factors described above which could be determined on a global scale. The choice between the group biotic endpoints will depend on the location of the emission. For example, if the emission occurred in northern Canada, it can be based in either autotrophs or heterotrophs in lakes while those occurring in (sub)tropical South America would be based on autotrophs in streams.

To obtain NS on the country, continent, and world resolution, grid-specific NS located within the spatial unit of interest (e.g. country), should be summed. The geographical location of the grid is given in the excel file, with latitude and longitude data on the grid’s centroid.

**Table 2.2** Available CFs for each world region. The CF ( $day \cdot m^3 \cdot kg^{-1}$ ) to be used to derive normalization scores is the average of the available CFs for the grid, which depends on the species group, freshwater type, and region where the grid is located.

Region	Autotroph		Heterotroph	
	Lake	Stream	Lake	Stream
(Sub)tropical	Not available	Available	Not available	Not available
Xeric	Available	Not available	Not available	Not available
Temperate	Available	Available	Available	Available
Cold	Available	Not available	Available	Not available

Weighted by inhabitant

Inhabitant-weighted grid-specific normalization scores (NS, unit:  $m^3 \cdot person^{-1}$ ) are described as:

$$NS_{Weight} = \frac{NS_{Non-weight}}{Pop} \tag{18}$$

Similarly to non-weighted NS, grid-specific NS values should be summed across the grids located within the spatial unit of interest, i.e. country, continent, and world, in order to obtain country, continent, or world-specific NS.

## 2.3 Results

Our results show that the *LEF* in the temperate region ranged from 397 to 1733 d·kgP<sup>-1</sup>·m<sup>3</sup> for lake autotrophs and stream heterotrophs, respectively (Figure 2.1). The highest *MEF* and *AEF* occur at TP concentrations ranging from 3.2E-4 to 1.0E-3 kgP·m<sup>-3</sup> for lake heterotrophs (Figure 2.1b), and 3.0E-4 to 5.0E-4 kgP·m<sup>-3</sup> for stream organisms (Figure 2.1c-d). Given that a high frequency of grids comprised  $C_{j,w}$  levels below the level which maximizes *MEF* and *AEF* (Figure 2.1b-d), our results show that CFs based on *LEF* are generally higher than those based on *MEF* and *AEF* (Figure 2.3 and Appendix 2-III). The differences between CFs based on *LEF* and those based on *MEF* and *AEF* were up to two orders of magnitude (Figure 2.9, Figure 2.10, Figure 2.11, and Figure 2.12 in Appendix 2-III). At  $C_{j,w}$  between 1.0E-3 and 1.0E-2 kgP·m<sup>-3</sup>, *AEF* was higher than *MEF* despite the fact that such TP levels were not frequent. This resulted in *MEF* and *AEF* differences within one order of magnitude in European grids.

As opposed to the other biotic endpoints, the lowest EFs for temperate lake autotrophs were found at the most eutrophic conditions (i.e. high  $C_{j,w}$ , Figure 2.1a). This is caused by a rapid decrease in PNOF values at decreasing  $C_{j,w}$  as opposed to the slower decrease in PNOF in other biotic endpoints. The four biotic endpoints generally differed up to two orders of magnitude for the concentration-dependent CFs, i.e. *MEF* and *AEF*, with heterotrophs comprising lower CFs than those for autotrophs in streams (Figure 2.14 and Figure 2.15 in Appendix 2-III).

CFs results based on *LEF* show that the highest impacts on lakes due to discharge of P to freshwaters would occur from emissions in high latitudes of the northern hemisphere, mountainous areas such as the Andes, the Himalayas, and the Zagros, and world's regions comprising high fractions of lake water, e.g. lakes Victoria and Baikal (Figure 2.2a-b). Grid, country, continent, and world CFs, emission data, and normalization scores can be found in Appendix 2-IV, Appendix 2-V, and Appendix 2-VI, respectively.

## 2.4 Discussion

We derived 0.5° x 0.5° endpoint CFs for freshwater eutrophication using three different types of EFs, i.e. linear (*LEF*), marginal (*MEF*), and average (*AEF*). The types differed in respect to the slope of the PNOF changes following TP increases, inclusion of a target TP level, and consideration of TP levels in the environment. In the following, we discuss the main factors driving (1) the differences between the CF types in a given region and (2) the differences of CFs results across regions. We also discuss the main uncertainties of our study and provide recommendations on the most appropriate effect factor to be used in LCIA methodology. Given that the *LEF* method is the only one that does not require that the actual P concentration in the environment  $C_{j,w}$  is known, comparisons of CFs across regions were limited to those based on *LEF*. Additionally, we limited the comparison between CFs based on *LEF*, *MEF*, and *AEF* to Europe, where  $C_{j,w}$  were widely available.

### 2.4.1 Differences between characterisation factor types

The EFs based on *LEF* were mostly larger compared to those based on actual TP levels, which resulted in higher CFs. That occurred because the majority of grids comprise  $C_{j,w}$  below the level which maximizes EFs. That reveals that, at current trophic conditions, the *LEF* method is a

conservative approach to quantify the impacts of P emissions to freshwaters. Ultimately, the choice of which EF to be employed drives is therefore crucial in determining CFs.

The *MEF* represents the change in PNOF due to a marginal change in  $C_{j,w}$  and, as opposed to *AEF*, it does not specify a target TP level ( $C_{j,w}=0$ ). As a result, for P increases in already eutrophic freshwaters (i.e.  $C_{j,w}$  above  $1.0E-3 \text{ kgP}\cdot\text{m}^{-3}$ ), *AEF*-based CFs of generally one order of magnitude higher than CFs based on *MEF*. Ultimately, a LCIA practitioner employing *MEF* might find little damage from further P discharges into freshwaters that were already subjected to past eutrophication (Huijbregts et al., 2011). Such eutrophic conditions, nevertheless, were seldom reported by the EEA.

The regional differences in CFs based on *LEF* for a similar biotic endpoint (i.e. autotrophs or heterotrophs in lakes or streams) are due to the differentiated fate factors in each grid cell and thermal differences in freshwaters. Given the slow flow of waters in lakes compared to rivers, P is retained for a longer period of time before being transported downstream (Helmes et al., 2012). In addition, environmental impacts may be reduced if species are exposed to more mild temperatures, as observed in fish in Finish lakes (Posch et al., 2012). Ultimately, regions of the world comprising large fractions of lake water, e.g. the African or North American Great Lakes areas, or with more adverse temperature regimes, e.g. cold regions, will encompass larger CFs.

#### 2.4.2 Effect factor uncertainties

The effect models of this study imply that the best-case scenario for P control in freshwaters is at environmental target ( $C_{j,w}$ ) equals zero. Nevertheless, a qualitative interpretation of what this target stands for is vital. In the *MEF* and *AEF*, the environmental footprint of eutrophication decreases with decreasing  $C_{j,w}$  (with the exception of temperate lake autotrophs). However, P is also an essential nutrient that is necessary at levels above zero (Azevedo et al., in press). In this study, we do not employ the target TP level as defined by Azevedo and colleagues (Unpublished) as this would imply that no environmental impact takes place following a TP level increase from current oligotrophic conditions to a target TP level. Furthermore, it is important to note that PNOF should be strictly interpreted as the inverse of relative species richness and it does not take into account specific changes to species composition, e.g. favoring of cyanobacteria or competitive exclusion of endemic species.

We used annual mean TP data per grid to represent  $C_{j,w}$ . Especially in cold regions (i.e. high latitude and altitude areas) there can be considerable variability in TP exposure throughout the year. As opposed to warmer freshwaters, the ecological damage in cold areas is mostly occurring in the summer months, when biological uptake is activated (Carpenter et al., 2001). For reasons of consistency, we employed mean annual concentration data despite the fact that colder regions may comprise larger temporal variability in their effect factors than warmer areas.

We used  $C_{j,w}$  from neighboring monitoring stations to account for the lack of monitoring data in certain grids. 32.14% and 60.16% of European grids contained at least one lake or stream monitoring station within it, respectively (Figure 2.4 in Appendix 2-II). The extrapolation of monitoring TP data to adjacent grids lacking monitoring stations was a necessary step since a CF is the summation of the impact to downstream grids and, by not accounting for grids where TP was not reported, their associated emitting grid would be underestimated compared to emitting grids having monitored downstream water bodies.

The results for heterotrophs in European streams obtained in this study can be compared with existing European-generic endpoint CFs based on MEF for stream macroinvertebrates (Struijs et al., 2011a). The TP levels used to derive our EFs (average TP in grids equals  $0.06 \text{ mg P}\cdot\text{L}^{-1}$ ) were generally lower TP levels than did Struijs and colleagues (average TP in river catchments equals  $2.1\text{E-}4 \text{ kg P}\cdot\text{m}^{-3}$ ) (Struijs et al., 2011a). We attribute that to the fact that Struijs and colleagues (Struijs et al., 2011a) use the main river catchments in Europe, that encompass stronger stream flow and higher quantities of (P-rich) soil particles than less polluted upstream tributaries (Nour et al., 2006) included in our study. Even so, the average *MEF* they find (average of  $163 \text{ m}^{-3}\cdot\text{kg P}$ ) is considerably lower than the *MEF* reported in our study (average in European grids equaled  $323 \text{ kg}\cdot\text{m}^{-3}$ ). An important model choice difference between our study and the study of Struijs and colleagues is that they attribute a no-effect ( $MEF = 0$ ) to TP levels below the optimum of  $1.0\text{E-}4 \text{ kg P}\cdot\text{m}^{-3}$  while we still derive *MEF* for changes in PNOF due to marginal changes in TP in oligotrophic conditions. A second motive is attributed to the fact that the PNOF is not based on richness of genera but on a lower taxonomic level (i.e. species). Biological monitoring also reported a lack of sensitivity to stream impairment at the family taxonomic level but not at the species level (Lenat and Resh, 2001). This discrepancy was attributed to intensive adaptive radiation (Lenat and Resh, 2001).

#### 2.4.3 Relevance, applicability and further research recommendations

This work derived endpoint CFs for freshwater eutrophication on a global scale using linear effect factors and, on an European scale, using linear, marginal, and average effect factors. The results of this work are relevant for the assessment of the impacts of P-triggered eutrophication in freshwaters. In the context of LCIA, the added value of this work compared to the currently recommended endpoint characterisation model (Struijs et al., 2011a) is (1) that it extends endpoint characterisation models to the global scale, which, up to know, were restricted to Europe, (2) it includes effects to autotrophs as well as heterotrophs and lakes as well as streams, and (3) it provides region-dependent effect factors. On a global scale, we were able to derive CFs based on linear effect factors that did not require the environmental concentration of P as an input parameter. On the European level, we were able to derive CFs based on two species types (autotrophs and heterotrophs) and two freshwater types (lakes and streams).

#### 2.4.4 Concluding remarks

Despite the increase in model complexity and parameter requirement compared to the *LEF*, we recommend that future LCIA methodologies take into account the actual TP concentration in freshwater by using the TP-dependent effect factors (*MEF* or *AEF*) in the derivation of CFs because the EFs are highly dependent on the actual TP levels. Meanwhile, the use of the concentration-independent *LEF* may be used for LCIA on a global scale until the thorough monitoring of TP levels in freshwaters is made. Finally, it is important for disparate water quality monitoring efforts worldwide to expand their geographic scope and improve data sharing.

We suggest that future research for effect factors for freshwater eutrophication should include (1) an expanded water quality monitoring data to non-European freshwaters, (2) a further description of the PNOF – TP relationships that were not available in this study, e.g. heterotrophs in (sub)tropical freshwaters, and, as already recommended by others (Helmes et al., 2012), and (3)

a thorough discussion on what the target P level should be and if species richness is an appropriate biotic endpoint in LCIA (Curran et al., 2010).

## **2.5 Published peer-reviewed deliverables**

Azevedo, L.A., Van Zelm, R., Elshout, P.M.F., Hendriks, A.J., Leuven, R.S.E.W., Struijs, J., de Zwart, D., Huijbregts, M.A.J., In press. Species richness – phosphorus relationships for lakes and streams worldwide. *Global Ecology and Biogeography*.

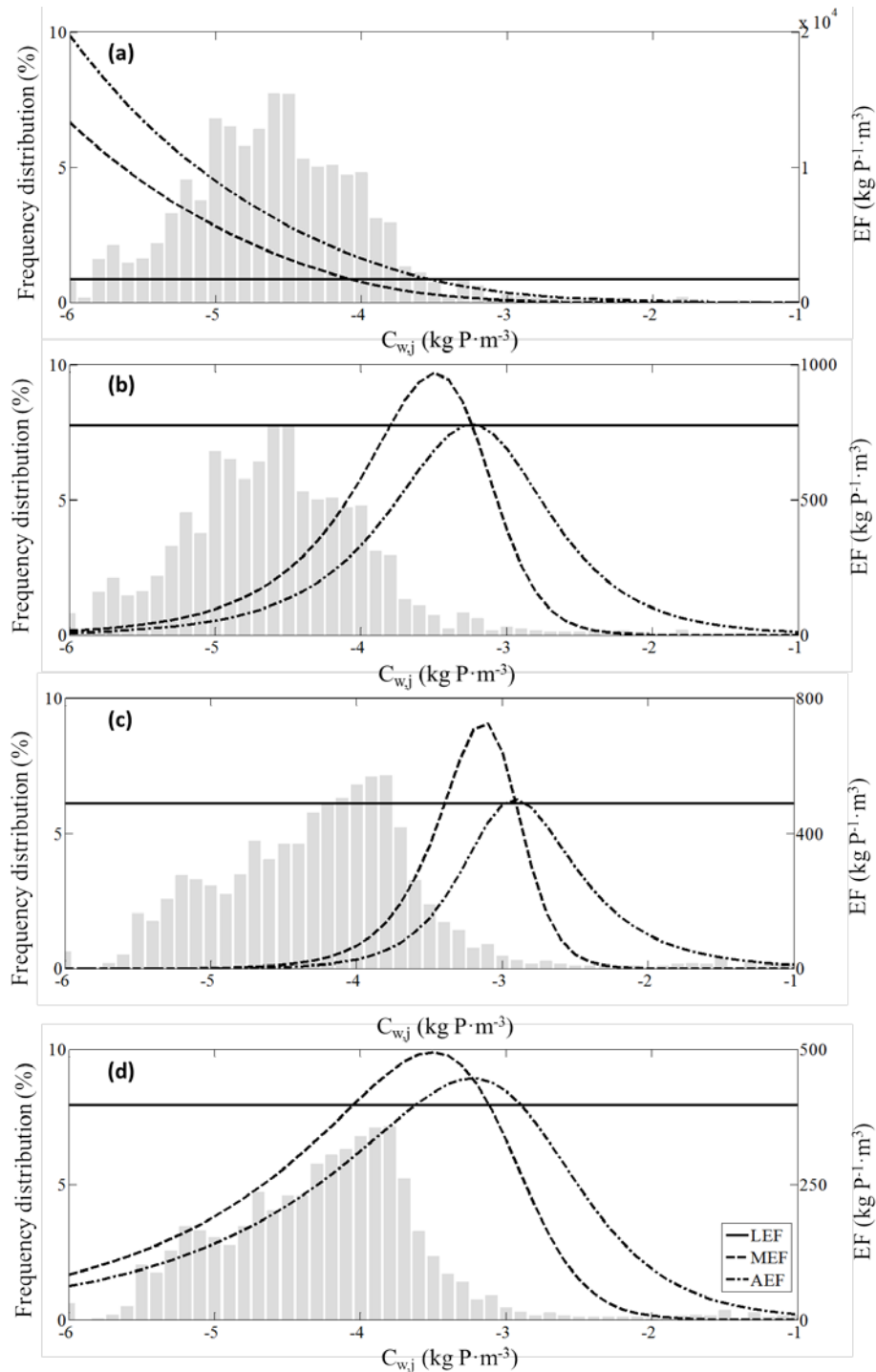
Helmes, R.J.K., Huijbregts, M.A.J., Henderson, A.D., Jolliet, O., 2012. Spatially explicit fate factors of phosphorous emissions to freshwater at the global scale. *International Journal of Life Cycle Assessment* 17, 646-654.

Struijs, J., De Zwart, D., Posthuma, L., Leuven, R.S.E.W., Huijbregts, M.A.J., 2011. Field sensitivity distribution of macroinvertebrates for phosphorus in inland waters. *Integrated Environmental Assessment and Management* 7, 280-286.

## 2.6 Tables and figures

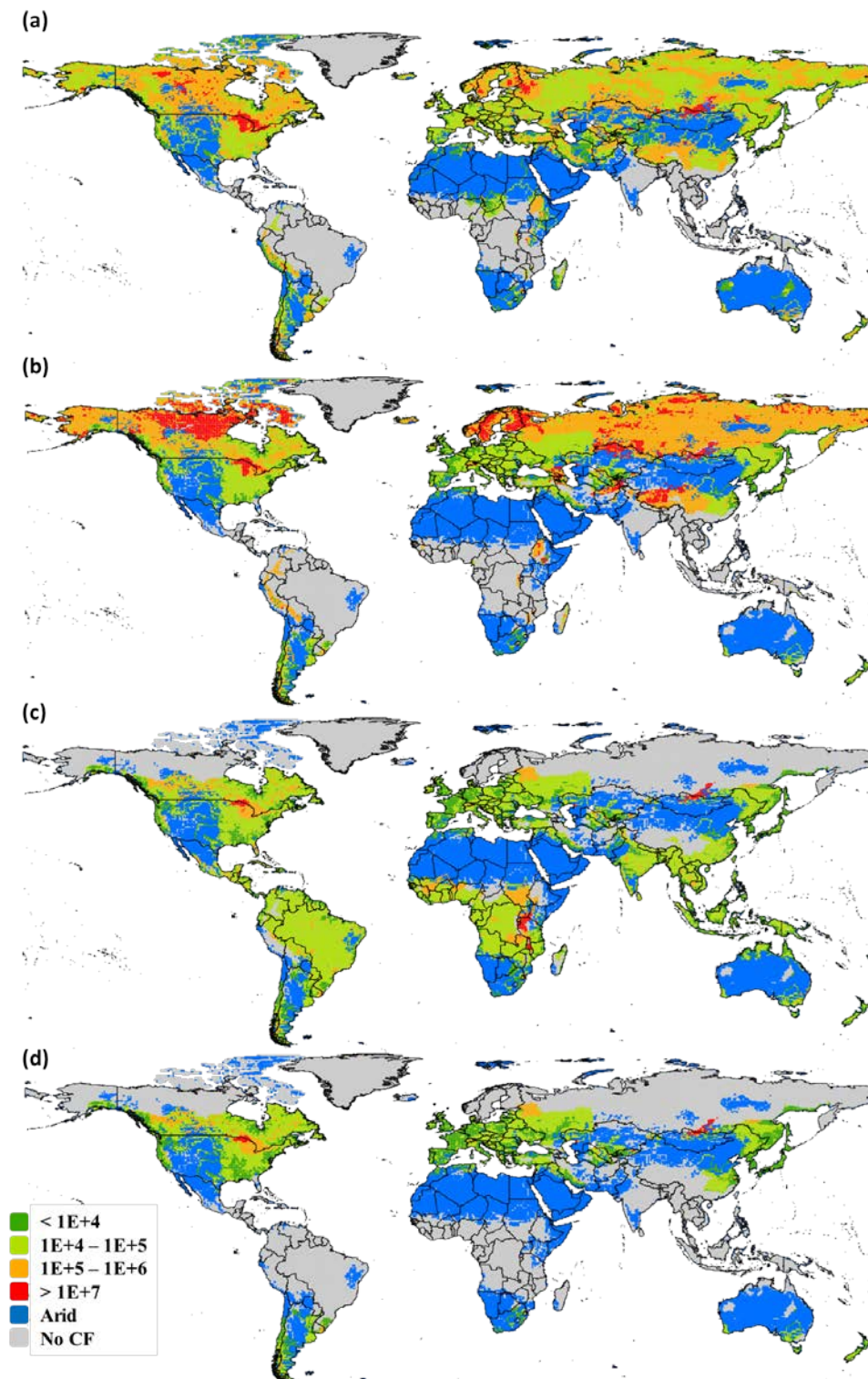
**Table 2.1:** Coefficients  $\alpha$  and  $\beta$  for autotrophs and heterotrophs based on TP concentrations ( $\text{kg P}\cdot\text{m}^{-3}$ ) reported by Azevedo and colleagues (Unpublished).

Region	$\alpha$	$\beta$
<b>Lake autotrophs</b>		
Temperate	-3.52 (-3.66 to -3.38)	-0.63 (-0.78 to -0.48)
Cold	-3.64 (-3.76 to -3.52)	-0.53 (-0.67 to -0.40)
Xeric	-2.97 (-3.07 to -2.86)	-0.39 (-0.50 to -0.28)
<b>Lake heterotrophs</b>		
Temperate	-3.19 (-3.23 to -3.15)	-0.24 (-0.281 to -0.21)
Cold	-4.37 (-4.43 to -4.31)	-0.12 (-0.18 to -0.07)
<b>Stream autotrophs</b>		
(Sub)tropical	-3.56 (-3.64 to -3.48)	-0.41 (-0.50 to -0.33)
Temperate	-2.99 (-3.02 to -2.96)	-0.17 (-0.20 to -0.15)
<b>Stream heterotrophs</b>		
Temperate	-2.87 (-3.02 to -2.71)	-0.32 (-0.36 to -0.29)

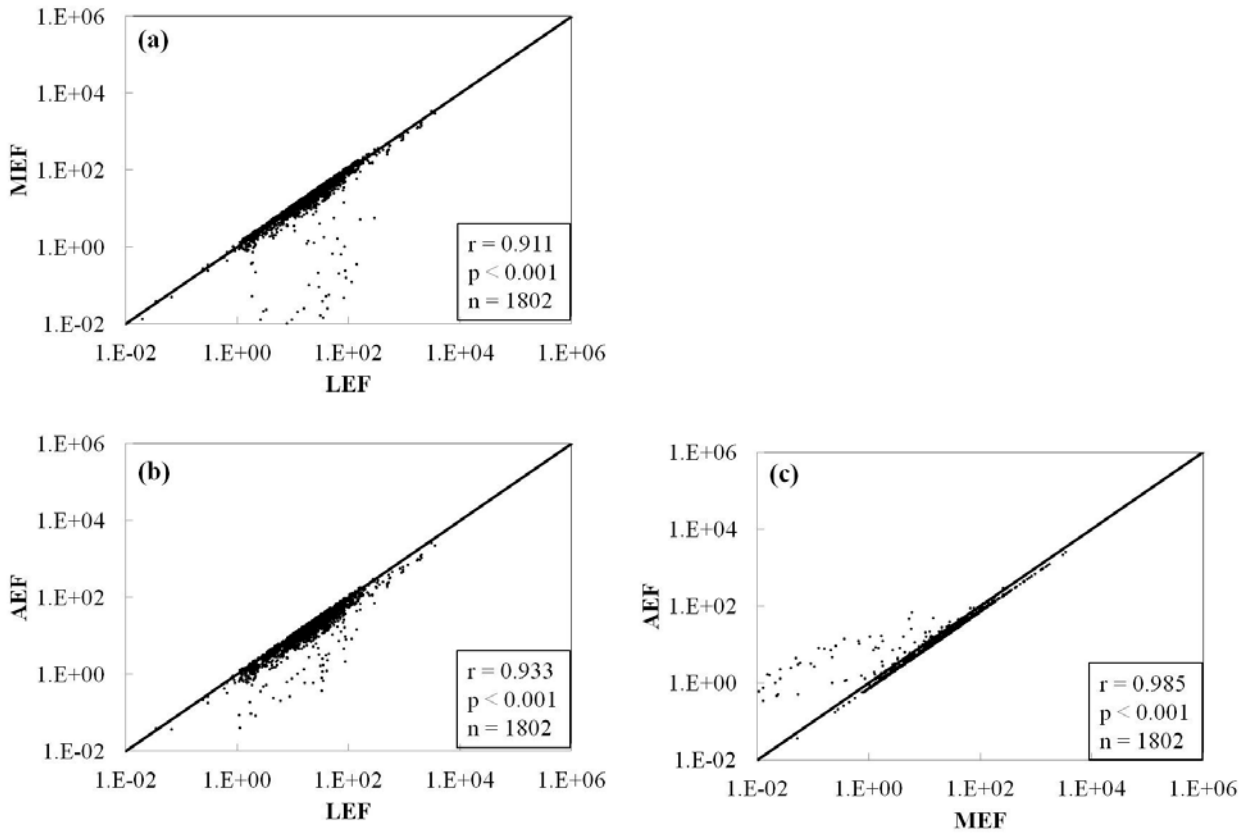


**Figure 2.1:** The linear (*LEF*), marginal (*MEF*), and average (*AEF*) effect factors (EF, right axis) represented by the continuous, dashed, and dot-dashed lines, respectively for (a) lake autotrophs, (b) lake heterotrophs, (c) stream autotrophs, and (d) stream heterotrophs along TP levels ( $^{10}\log C_{w,j}$ ) in temperate European grids. The frequency distribution (left axis,) of TP concentration in temperate lakes (a-b) and streams (c-d) in European grids is shown by the grey bars.





**Figure 2.2:** Characterisation factors (CFs,  $\text{day}\cdot\text{kg}\cdot\text{P}^{-1}\cdot\text{m}^3$ ) using the linear effect factors (*LEF*) for (a) lake autotrophs, (b) lake heterotrophs, (c) stream autotrophs, and (d) stream heterotrophs. For grey areas log-logistic regression coefficients were not available.



**Figure 2.3:** Comparison between characterisation factors (CFs,  $\text{day}\cdot\text{kgP}^{-1}\cdot\text{m}^3$ ) using the linear (*LEF*), marginal (*MEF*), and average (*AEF*) effect factors in each emitting grid for stream heterotrophs. Results of the spearman correlation (correlation coefficient, sample size, and p value) are shown on the bottom right of each graph. The same comparisons for lake autotrophs and heterotrophs and stream autotrophs are shown in Appendix 2-III.

## 2.7 Supporting information

### Appendix 2-I: Allocation of grids to their respective region

First, each 0.5° x 0.5° grid was allocated to its respective freshwater ecoregion using the map provided by Robin Abell and colleagues (2008) in ArcGIS 9.2 and classified each MHT type into four regions following Azevedo and colleagues (Unpublished). The list of freshwater ecoregions, their respective MHT class, and the re-classified habitat type is shown in Table 2.2 of this appendix. All oceanic islands MHT classes were re-classified to the (sub)tropical region. The ecoregions within large lakes and large river deltas MHT classes were re-classified based on their closest ecoregion.

**Table 2.2:** Allocation of each ecoregion to its respective original MHT (following the Freshwater Ecoregions Of The World definition, <http://www.feow.org>) and the new habitat name for the purpose of this study.

Ecoregion as defined by Abell and colleagues (2008)	Original MTH name as defined by FEOW	Region
Aceh	tropical and subtropical coastal rivers	(sub)tropical
Aegean Drainages	temperate coastal rivers	temperate
Alaska & Canada Pacific Coastal	temperate coastal rivers	temperate
Alaskan Coastal	polar freshwaters	cold
Albertine Highlands	montane freshwaters	cold
Amatolo - Winterberg Highlands	montane freshwaters	cold
Amazonas Estuary & Coastal Drainages	large river deltas*	(sub)tropical
Amazonas Guiana Shield	tropical and subtropical upland rivers	(sub)tropical
Amazonas High Andes	montane freshwaters	cold
Amazonas Lowlands	tropical and subtropical floodplain rivers and wet	(sub)tropical
Ameca - Manantlan	tropical and subtropical coastal rivers	(sub)tropical
Anadyr	polar freshwaters	cold
Andaman Islands	oceanic islands*	(sub)tropical
Apalachicola	temperate floodplain rivers and wetlands	temperate
Appalachian Piedmont	temperate coastal rivers	temperate
Arabian Interior	xeric freshwaters and endorheic (closed) basins	xeric
Arafura - Carpentaria	tropical and subtropical coastal rivers	(sub)tropical
Aral Sea Drainages	large lakes*	temperate
Argun	temperate upland rivers	temperate
Ashanti	tropical and subtropical coastal rivers	(sub)tropical
Atacama	xeric freshwaters and endorheic (closed) basins	xeric

<b>Ecoregion as defined by Abell and colleagues (2008)</b>	<b>Original MTH name as defined by FEOW</b>	<b>Region</b>
Atlantic Northwest Africa	temperate coastal rivers	temperate
Bahama Archipelago	tropical and subtropical coastal rivers	(sub)tropical
Balkash - Alakul	xeric freshwaters and endorheic (closed) basins	xeric
Baluchistan	xeric freshwaters and endorheic (closed) basins	xeric
Bangweulu - Mweru	tropical and subtropical floodplain rivers and wet	(sub)tropical
Barents Sea Drainages	polar freshwaters	cold
Bass Strait Drainages	temperate coastal rivers	temperate
Bight Drainages	tropical and subtropical coastal rivers	(sub)tropical
Bismarck Archipelago	tropical and subtropical coastal rivers	(sub)tropical
Bonaerensean Drainages	temperate coastal rivers	temperate
Bonneville	xeric freshwaters and endorheic (closed) basins	xeric
Borneo Highlands	tropical and subtropical upland rivers	(sub)tropical
Canadian Arctic Archipelago	polar freshwaters	cold
Canadian Atlantic Islands	temperate coastal rivers	temperate
Cantabric Coast - Languedoc	temperate coastal rivers	temperate
Cape Fold	temperate coastal rivers	temperate
Caspian Highlands	xeric freshwaters and endorheic (closed) basins	xeric
Caspian Marine	large lakes*	temperate
Central & Eastern Java	tropical and subtropical coastal rivers	(sub)tropical
Central & Western Europe	temperate floodplain rivers and wetlands	temperate
Central Anatolia	xeric freshwaters and endorheic (closed) basins	xeric
Central Andean Pacific Slopes	xeric freshwaters and endorheic (closed) basins	xeric
Central Arctic Coastal	polar freshwaters	cold
Central Prairie	temperate upland rivers	temperate
Chaco	tropical and subtropical floodplain rivers and wet	(sub)tropical
Chagres	tropical and subtropical coastal rivers	(sub)tropical
Chao Phraya	tropical and subtropical floodplain rivers and wet	(sub)tropical
Chesapeake Bay	temperate coastal rivers	temperate
Chiapas - Fonseca	tropical and subtropical coastal rivers	(sub)tropical
Chin Hills - Arakan Coast	tropical and subtropical coastal rivers	(sub)tropical
Chiriqui	tropical and subtropical coastal rivers	(sub)tropical
Chuya	montane freshwaters	cold
Coastal Amur	temperate coastal rivers	temperate
Coastal East Africa	tropical and subtropical coastal rivers	(sub)tropical

<b>Ecoregion as defined by Abell and colleagues (2008)</b>	<b>Original MTH name as defined by FEOW</b>	<b>Region</b>
Coastal Fujian - Zeijang	tropical and subtropical coastal rivers	(sub)tropical
Coastal Levant	xeric freshwaters and endorheic (closed) basins	xeric
Coatzacoalcos	tropical and subtropical coastal rivers	(sub)tropical
Colorado	xeric freshwaters and endorheic (closed) basins	xeric
Columbia Glaciated	temperate upland rivers	temperate
Columbia Unglaciated	temperate floodplain rivers and wetlands	temperate
Crimea Peninsula	temperate coastal rivers	temperate
Cuanza	tropical and subtropical coastal rivers	(sub)tropical
Cuba - Cayman Islands	tropical and subtropical coastal rivers	(sub)tropical
Cumberland	temperate upland rivers	temperate
Cuvette Centrale	tropical and subtropical floodplain rivers and wet	(sub)tropical
Cuyan - Desaguadero	montane freshwaters	cold
Dalmatia	temperate coastal rivers	temperate
Death Valley	xeric freshwaters and endorheic (closed) basins	xeric
Dnieper - South Bug	temperate floodplain rivers and wetlands	temperate
Dniester - Lower Danube	temperate floodplain rivers and wetlands	temperate
Don	temperate floodplain rivers and wetlands	temperate
Drakensberg - Maloti Highlands	montane freshwaters	cold
Dry Sahel	xeric freshwaters and endorheic (closed) basins	xeric
Dzungaria	xeric freshwaters and endorheic (closed) basins	xeric
East Chukotka	polar freshwaters	cold
East Texas Gulf	temperate coastal rivers	temperate
Eastern Borneo	tropical and subtropical floodplain rivers and wet	(sub)tropical
Eastern Coastal Australia	tropical and subtropical coastal rivers	(sub)tropical
Eastern Gulf of Thailand Drainages	tropical and subtropical coastal rivers	(sub)tropical
Eastern Hudson Bay - Ungava	temperate coastal rivers	temperate
Eastern Iberia	temperate coastal rivers	temperate
Eastern Taiwan	tropical and subtropical coastal rivers	(sub)tropical
Eastern Yellow Sea Drainages	temperate coastal rivers	temperate
Eastern Zimbabwe Highlands	montane freshwaters	cold
Eburneo	tropical and subtropical coastal rivers	(sub)tropical
English - Winnipeg Lakes	large lakes*	temperate
Er Hai	montane freshwaters	cold
Esfahan	xeric freshwaters and endorheic (closed)	xeric

Ecoregion as defined by Abell and colleagues (2008)	Original MTH name as defined by FEOW	Region
	basins	
Essequibo	tropical and subtropical upland rivers	(sub)tropical
Estero Real - Tempisque	tropical and subtropical coastal rivers	(sub)tropical
Ethiopian Highlands	montane freshwaters	cold
Etosha	xeric freshwaters and endorheic (closed) basins	xeric
Fiji	oceanic islands*	(sub)tropical
Florida Peninsula	tropical and subtropical coastal rivers	(sub)tropical
Fluminense	tropical and subtropical coastal rivers	(sub)tropical
Fouta - Djallon	montane freshwaters	cold
Galapagos Islands	oceanic islands*	(sub)tropical
Ganges Delta & Plain	tropical and subtropical floodplain rivers and wet	(sub)tropical
Ganges Himalayan Foothills	tropical and subtropical upland rivers	(sub)tropical
Gila	xeric freshwaters and endorheic (closed) basins	xeric
Grijalva - Usumacinta	tropical and subtropical coastal rivers	(sub)tropical
Guapore - Itenez	tropical and subtropical upland rivers	(sub)tropical
Guianas	tropical and subtropical upland rivers	(sub)tropical
Gulf of St.Lawrence Coastal Drainages	temperate coastal rivers	temperate
Gulf of Venice Drainages	temperate coastal rivers	temperate
Guzman - Samalayuca	xeric freshwaters and endorheic (closed) basins	xeric
Hainan	tropical and subtropical coastal rivers	(sub)tropical
Hamgyong - Sanmaek	temperate coastal rivers	temperate
Hawaiian Islands	oceanic islands*	(sub)tropical
Helmand - Sistan	xeric freshwaters and endorheic (closed) basins	xeric
Hispaniola	tropical and subtropical coastal rivers	(sub)tropical
Honshu - Shikoku - Kyushu	temperate coastal rivers	temperate
Horn of Africa	xeric freshwaters and endorheic (closed) basins	xeric
Huang He Great Bend	temperate floodplain rivers and wetlands	temperate
Iceland - Jan Mayen	polar freshwaters	cold
Iguassu	tropical and subtropical upland rivers	(sub)tropical
Indian Ocean Slope of Sumatra & Java	tropical and subtropical coastal rivers	(sub)tropical
Indus Himalayan Foothills	tropical and subtropical upland rivers	(sub)tropical
Inner Mongolia Endorheic Basins	xeric freshwaters and endorheic (closed) basins	xeric
Inner Niger Delta	tropical and subtropical floodplain rivers and wet	(sub)tropical



<b>Ecoregion as defined by Abell and colleagues (2008)</b>	<b>Original MTH name as defined by FEOW</b>	<b>Region</b>
Ionian Drainages	temperate coastal rivers	temperate
Irgyz -Turgai	xeric freshwaters and endorheic (closed) basins	xeric
Isthmus Caribbean	tropical and subtropical coastal rivers	(sub)tropical
Italian Peninsula & Islands	temperate coastal rivers	temperate
Jamaica	tropical and subtropical coastal rivers	(sub)tropical
Jordan River	xeric freshwaters and endorheic (closed) basins	xeric
Kafue	tropical and subtropical floodplain rivers and wet	(sub)tropical
Kalahari	xeric freshwaters and endorheic (closed) basins	xeric
Kamchatka & Northern Kurils	polar freshwaters	cold
Kapuas	tropical and subtropical floodplain rivers and wet	(sub)tropical
Karoo	xeric freshwaters and endorheic (closed) basins	xeric
Karstveld Sink Holes	xeric freshwaters and endorheic (closed) basins	xeric
Kasai	tropical and subtropical floodplain rivers and wet	(sub)tropical
Kavir & Lut Deserts	xeric freshwaters and endorheic (closed) basins	xeric
Khorat Plateau (Mekong)	tropical and subtropical floodplain rivers and wet	(sub)tropical
Kimberley	tropical and subtropical coastal rivers	(sub)tropical
Kolyma	polar freshwaters	cold
Koryakia	polar freshwaters	cold
Kratie - Stung Treng (Mekong)	tropical and subtropical floodplain rivers and wet	(sub)tropical
Kuban	montane freshwaters	cold
Kura - South Caspian Drainages	montane freshwaters	cold
Laguna dos Patos	temperate coastal rivers	temperate
Lahontan	xeric freshwaters and endorheic (closed) basins	xeric
Lake Baikal	large lakes*	temperate
Lake Chad	xeric freshwaters and endorheic (closed) basins	xeric
Lake Eyre Basin	xeric freshwaters and endorheic (closed) basins	xeric
Lake Issyk Kul - Upper Chu	large lakes*	temperate
Lake Malawi	large lakes*	(sub)tropical
Lake Onega - Lake Ladoga	large lakes*	temperate
Lake Rukwa	large lakes*	(sub)tropical

<b>Ecoregion as defined by Abell and colleagues (2008)</b>	<b>Original MTH name as defined by FEOW</b>	<b>Region</b>
Lake Tana	montane freshwaters	cold
Lake Tanganyika	large lakes*	(sub)tropical
Lake Turkana	large lakes*	(sub)tropical
Lake Van	xeric freshwaters and endorheic (closed) basins	xeric
Lake Victoria Basin	large lakes*	(sub)tropical
Laurentian Great Lakes	large lakes*	temperate
Lena	polar freshwaters	cold
Lerma - Chapala	xeric freshwaters and endorheic (closed) basins	xeric
Lesser Sunda Islands	oceanic islands*	(sub)tropical
Liao He	temperate floodplain rivers and wetlands	temperate
Llanos El Salado	xeric freshwaters and endorheic (closed) basins	xeric
Lower & Middle Indus	tropical and subtropical floodplain rivers and wet	(sub)tropical
Lower & Middle Salween	tropical and subtropical upland rivers	(sub)tropical
Lower & Middle Syr Darya	temperate upland rivers	temperate
Lower Amur	temperate floodplain rivers and wetlands	temperate
Lower Congo	tropical and subtropical floodplain rivers and wet	(sub)tropical
Lower Huang He	temperate floodplain rivers and wetlands	temperate
Lower Lancang (Mekong)	tropical and subtropical floodplain rivers and wet	(sub)tropical
Lower Mackenzie	polar freshwaters	cold
Lower Mississippi	temperate floodplain rivers and wetlands	temperate
Lower Niger - Benue	tropical and subtropical floodplain rivers and wet	(sub)tropical
Lower Nile	xeric freshwaters and endorheic (closed) basins	xeric
Lower Parana	temperate floodplain rivers and wetlands	temperate
Lower Rio Grande - Bravo	temperate floodplain rivers and wetlands	temperate
Lower Tigris & Euphrates	temperate floodplain rivers and wetlands	temperate
Lower Uruguay	tropical and subtropical upland rivers	(sub)tropical
Lower Yangtze	temperate floodplain rivers and wetlands	temperate
Lower Zambezi	tropical and subtropical floodplain rivers and wet	(sub)tropical
Madagascar Eastern Highlands	montane freshwaters	cold
Madagascar Eastern Lowlands	tropical and subtropical coastal rivers	(sub)tropical
Madeira Brazilian Shield	tropical and subtropical upland rivers	(sub)tropical
Mae Khlong	tropical and subtropical floodplain rivers and wet	(sub)tropical
Magdalena - Sinu	tropical and subtropical upland rivers	(sub)tropical



<b>Ecoregion as defined by Abell and colleagues (2008)</b>	<b>Original MTH name as defined by FEOW</b>	<b>Region</b>
Mai Ndombe	tropical and subtropical floodplain rivers and wet	(sub)tropical
Malagarasi - Moyowosi	tropical and subtropical floodplain rivers and wet	(sub)tropical
Malay Peninsula Eastern Slope	tropical and subtropical floodplain rivers and wet	(sub)tropical
Malebo Pool	tropical and subtropical floodplain rivers and wet	(sub)tropical
Malukku	oceanic islands*	(sub)tropical
Mamore - Madre de Dios Piedmont	tropical and subtropical upland rivers	(sub)tropical
Mar Chiquita - Salinas Grandes	xeric freshwaters and endorheic (closed) basins	xeric
Maracaibo	large lakes*	(sub)tropical
Mascarenes	oceanic islands*	(sub)tropical
Mayran - Viesca	xeric freshwaters and endorheic (closed) basins	xeric
Mediterranean Northwest Africa	temperate coastal rivers	temperate
Mekong Delta	tropical and subtropical floodplain rivers and wet	(sub)tropical
Middle Amu Darya	temperate upland rivers	temperate
Middle Amur	temperate upland rivers	temperate
Middle Brahmaputra	tropical and subtropical upland rivers	(sub)tropical
Middle Missouri	temperate floodplain rivers and wetlands	temperate
Middle Saskatchewan	temperate upland rivers	temperate
Middle Yangtze	montane freshwaters	cold
Middle Zambezi - Luangwa	tropical and subtropical floodplain rivers and wet	(sub)tropical
Mindanao	tropical and subtropical coastal rivers	(sub)tropical
Mobile Bay	temperate floodplain rivers and wetlands	temperate
Mosquitia	tropical and subtropical coastal rivers	(sub)tropical
Mulanje	montane freshwaters	cold
Murray - Darling	temperate floodplain rivers and wetlands	temperate
Namak	xeric freshwaters and endorheic (closed) basins	xeric
Namib	xeric freshwaters and endorheic (closed) basins	xeric
Namuda - Tapi	tropical and subtropical floodplain rivers and wet	(sub)tropical
New Caledonia	tropical and subtropical coastal rivers	(sub)tropical
New Guinea Central Mountains	montane freshwaters	cold
New Guinea North Coast	tropical and subtropical coastal rivers	(sub)tropical

<b>Ecoregion as defined by Abell and colleagues (2008)</b>	<b>Original MTH name as defined by FEOW</b>	<b>Region</b>
New Zealand	temperate coastal rivers	temperate
Niger Delta	large river deltas*	(sub)tropical
Nile Delta	large river deltas*	xeric
North Andean Pacific Slopes - Rio Atrato	tropical and subtropical coastal rivers	(sub)tropical
Northeast US & Southeast Canada Atlantic Drainages	temperate coastal rivers	temperate
Northeastern Borneo	tropical and subtropical coastal rivers	(sub)tropical
Northeastern Caatinga & Coastal Drainages	tropical and subtropical coastal rivers	(sub)tropical
Northeastern Mata Atlantica	tropical and subtropical coastal rivers	(sub)tropical
Northern Anatolia	temperate coastal rivers	temperate
Northern Annam	tropical and subtropical coastal rivers	(sub)tropical
Northern Baltic Drainages	polar freshwaters	cold
Northern British Isles	temperate coastal rivers	temperate
Northern Central Asian Highlands	temperate upland rivers	temperate
Northern Central Sumatra - Western Malaysia	tropical and subtropical coastal rivers	(sub)tropical
Northern Deccan Plateau	tropical and subtropical floodplain rivers and wet	(sub)tropical
Northern Eastern Rift	xeric freshwaters and endorheic (closed) basins	xeric
Northern Gulf of Guinea Drainages - Bioko	tropical and subtropical coastal rivers	(sub)tropical
Northern Hormuz Drainages	temperate coastal rivers	temperate
Northern Philippine Islands	tropical and subtropical coastal rivers	(sub)tropical
Northern Upper Guinea	tropical and subtropical coastal rivers	(sub)tropical
Northwestern Borneo	tropical and subtropical coastal rivers	(sub)tropical
Northwestern Madagascar	tropical and subtropical floodplain rivers and wet	(sub)tropical
Norwegian Sea Drainages	polar freshwaters	cold
Ob	polar freshwaters	cold
Ogooue - Nyanga - Kouilou - Niari	tropical and subtropical coastal rivers	(sub)tropical
Okavango	tropical and subtropical floodplain rivers and wet	(sub)tropical
Okhotsk Coast	temperate coastal rivers	temperate
Oman Mountains	xeric freshwaters and endorheic (closed) basins	xeric
Oregon & Northern California Coastal	temperate coastal rivers	temperate
Oregon Lakes	xeric freshwaters and endorheic (closed) basins	xeric

<b>Ecoregion as defined by Abell and colleagues (2008)</b>	<b>Original MTH name as defined by FEOW</b>	<b>Region</b>
Orinoco Delta & Coastal Drainages	large river deltas*	(sub)tropical
Orinoco Guiana Shield	tropical and subtropical upland rivers	(sub)tropical
Orinoco Llanos	tropical and subtropical floodplain rivers and wet	(sub)tropical
Orinoco Piedmont	montane freshwaters	cold
Orontes	temperate coastal rivers	temperate
Orumiyeh	xeric freshwaters and endorheic (closed) basins	xeric
Ouachita Highlands	temperate upland rivers	temperate
Ozark Highlands	temperate upland rivers	temperate
Palawan - Busuanga - Mindoro	tropical and subtropical coastal rivers	(sub)tropical
Paleo	xeric freshwaters and endorheic (closed) basins	xeric
Pangani	tropical and subtropical coastal rivers	(sub)tropical
Panuco	tropical and subtropical coastal rivers	(sub)tropical
Papaloapan	tropical and subtropical coastal rivers	(sub)tropical
Papuan Peninsula	tropical and subtropical coastal rivers	(sub)tropical
Paraguay	tropical and subtropical floodplain rivers and wet	(sub)tropical
Paraiba do Sul	tropical and subtropical coastal rivers	(sub)tropical
Parnaiba	tropical and subtropical coastal rivers	(sub)tropical
Patagonia	temperate coastal rivers	temperate
Pecos	xeric freshwaters and endorheic (closed) basins	xeric
Pilbara	xeric freshwaters and endorheic (closed) basins	xeric
Puerto Rico - Virgin Islands	tropical and subtropical coastal rivers	(sub)tropical
Qaidan	montane freshwaters	cold
Quintana Roo - Motagua	tropical and subtropical coastal rivers	(sub)tropical
Ribeira de Iguape	tropical and subtropical coastal rivers	(sub)tropical
Rio Balsas	tropical and subtropical coastal rivers	(sub)tropical
Rio Conchos	xeric freshwaters and endorheic (closed) basins	xeric
Rio Negro	tropical and subtropical floodplain rivers and wet	(sub)tropical
Rio Salado	xeric freshwaters and endorheic (closed) basins	xeric
Rio San Juan (Mexico)	xeric freshwaters and endorheic (closed) basins	xeric
Rio Santiago	tropical and subtropical coastal rivers	(sub)tropical
Rio Tuira	tropical and subtropical coastal rivers	(sub)tropical
S. Francisco	tropical and subtropical upland rivers	(sub)tropical
Sabine - Galveston	temperate coastal rivers	temperate

<b>Ecoregion as defined by Abell and colleagues (2008)</b>	<b>Original MTH name as defined by FEOW</b>	<b>Region</b>
Sacramento - San Joaquin	temperate coastal rivers	temperate
Sahara	xeric freshwaters and endorheic (closed) basins	xeric
Sakhalin, Hokkaido, & Sikhote - Alin Coast	temperate coastal rivers	temperate
San Juan (Nicaragua/Costa Rica)	tropical and subtropical coastal rivers	(sub)tropical
Sangha	tropical and subtropical floodplain rivers and wet	(sub)tropical
Santa Maria	tropical and subtropical coastal rivers	(sub)tropical
Scotia - Fundy	temperate coastal rivers	temperate
Senegal - Gambia	tropical and subtropical floodplain rivers and wet	(sub)tropical
Shebelle - Juba	xeric freshwaters and endorheic (closed) basins	xeric
Shilka (Amur)	temperate upland rivers	temperate
Sierra Madre del Sur	tropical and subtropical coastal rivers	(sub)tropical
Sinai	xeric freshwaters and endorheic (closed) basins	xeric
Sinaloa	tropical and subtropical coastal rivers	(sub)tropical
Sitang - Irawaddy	tropical and subtropical floodplain rivers and wet	(sub)tropical
Solomon Islands	tropical and subtropical coastal rivers	(sub)tropical
Song Hong	tropical and subtropical floodplain rivers and wet	(sub)tropical
Songhua Jiang	temperate floodplain rivers and wetlands	temperate
Sonora	xeric freshwaters and endorheic (closed) basins	xeric
South America Caribbean Drainages - Trinidad	tropical and subtropical coastal rivers	(sub)tropical
South Andean Pacific Slopes	temperate coastal rivers	temperate
Southeast Adriatic Drainages	temperate coastal rivers	temperate
Southeastern Borneo	tropical and subtropical floodplain rivers and wet	(sub)tropical
Southeastern Ghats	tropical and subtropical coastal rivers	(sub)tropical
Southeastern Korean Peninsula	temperate coastal rivers	temperate
Southeastern Mata Atlantica	tropical and subtropical coastal rivers	(sub)tropical
Southern Anatolia	temperate coastal rivers	temperate
Southern Annam	tropical and subtropical coastal rivers	(sub)tropical
Southern Baltic Lowlands	temperate floodplain rivers and wetlands	temperate
Southern California Coastal - Baja California	xeric freshwaters and endorheic (closed) basins	xeric
Southern Central Sumatra	tropical and subtropical floodplain rivers and wet	(sub)tropical

<b>Ecoregion as defined by Abell and colleagues (2008)</b>	<b>Original MTH name as defined by FEOW</b>	<b>Region</b>
Southern Deccan Plateau	tropical and subtropical floodplain rivers and wet	(sub)tropical
Southern Eastern Rift	xeric freshwaters and endorheic (closed) basins	xeric
Southern Gulf of Guinea Drainages	tropical and subtropical coastal rivers	(sub)tropical
Southern Hudson Bay	temperate coastal rivers	temperate
Southern Iberia	temperate coastal rivers	temperate
Southern Kalahari	xeric freshwaters and endorheic (closed) basins	xeric
Southern Madagascar	xeric freshwaters and endorheic (closed) basins	xeric
Southern Sumatra - Western Java	tropical and subtropical floodplain rivers and wet	(sub)tropical
Southern Tasmania	temperate coastal rivers	temperate
Southern Temperate Highveld	temperate upland rivers	temperate
Southern Upper Guinea	tropical and subtropical coastal rivers	(sub)tropical
Southwest New Guinea - Trans-Fly Lowland	tropical and subtropical coastal rivers	(sub)tropical
Southwestern Arabian Coast	xeric freshwaters and endorheic (closed) basins	xeric
Southwestern Australia	temperate coastal rivers	temperate
Sri Lanka Dry Zone	tropical and subtropical coastal rivers	(sub)tropical
Sri Lanka Wet Zone	tropical and subtropical coastal rivers	(sub)tropical
St.Lawrence	temperate coastal rivers	temperate
Sudanic Congo - Oubangi	tropical and subtropical floodplain rivers and wet	(sub)tropical
Sulawesi	tropical and subtropical coastal rivers	(sub)tropical
Taimyr	polar freshwaters	cold
Tana, Athi & Coastal Drainages	tropical and subtropical coastal rivers	(sub)tropical
Tapajos - Juruena	tropical and subtropical upland rivers	(sub)tropical
Tarim	xeric freshwaters and endorheic (closed) basins	xeric
Teays - Old Ohio	temperate upland rivers	temperate
Tennessee	temperate upland rivers	temperate
Thrace	temperate coastal rivers	temperate
Tibetan Plateau Endorheic Drainages	montane freshwaters	cold
Titicaca	xeric freshwaters and endorheic (closed) basins	xeric
Tocantins - Araguaia	tropical and subtropical upland rivers	(sub)tropical
Tumba	tropical and subtropical floodplain rivers and wet	(sub)tropical
Turan Plain	xeric freshwaters and endorheic (closed)	xeric

<b>Ecoregion as defined by Abell and colleagues (2008)</b>	<b>Original MTH name as defined by FEOW</b>	<b>Region</b>
	basins	
Ucayali - Urubamba Piedmont	montane freshwaters	cold
Uele	tropical and subtropical upland rivers	(sub)tropical
Upper Amu Darya	montane freshwaters	cold
Upper Brahmaputra	montane freshwaters	cold
Upper Congo	tropical and subtropical upland rivers	(sub)tropical
Upper Danube	temperate floodplain rivers and wetlands	temperate
Upper Huang He	montane freshwaters	cold
Upper Huang He Corridor	montane freshwaters	cold
Upper Indus	montane freshwaters	cold
Upper Irtysh	temperate upland rivers	temperate
Upper Lancang (Mekong)	tropical and subtropical upland rivers	(sub)tropical
Upper Lualaba	tropical and subtropical floodplain rivers and wet	(sub)tropical
Upper Mackenzie	temperate floodplain rivers and wetlands	temperate
Upper Mississippi	temperate floodplain rivers and wetlands	temperate
Upper Missouri	temperate upland rivers	temperate
Upper Niger	tropical and subtropical upland rivers	(sub)tropical
Upper Nile	tropical and subtropical floodplain rivers and wet	(sub)tropical
Upper Parana	tropical and subtropical upland rivers	(sub)tropical
Upper Rio Grande - Bravo	temperate upland rivers	temperate
Upper Salween	tropical and subtropical upland rivers	(sub)tropical
Upper Saskatchewan	temperate upland rivers	temperate
Upper Snake	temperate upland rivers	temperate
Upper Tigris & Euphrates	temperate floodplain rivers and wetlands	temperate
Upper Uruguay	tropical and subtropical upland rivers	(sub)tropical
Upper Usumacinta	tropical and subtropical upland rivers	(sub)tropical
Upper Yangtze	montane freshwaters	cold
Upper Yukon	polar freshwaters	cold
Upper Zambezi Floodplains	tropical and subtropical floodplain rivers and wet	(sub)tropical
US Southern Plains	temperate upland rivers	temperate
Valdivian Lakes	temperate coastal rivers	temperate
Vanuatu	oceanic islands*	(sub)tropical
Vardar	temperate coastal rivers	temperate
Vegas - Virgin	xeric freshwaters and endorheic (closed) basins	xeric
Vogelkop - Bomberai	tropical and subtropical coastal rivers	(sub)tropical
Volga - Ural	temperate floodplain rivers and wetlands	temperate
Volga Delta - Northern Caspian Drainages	large lakes*	temperate

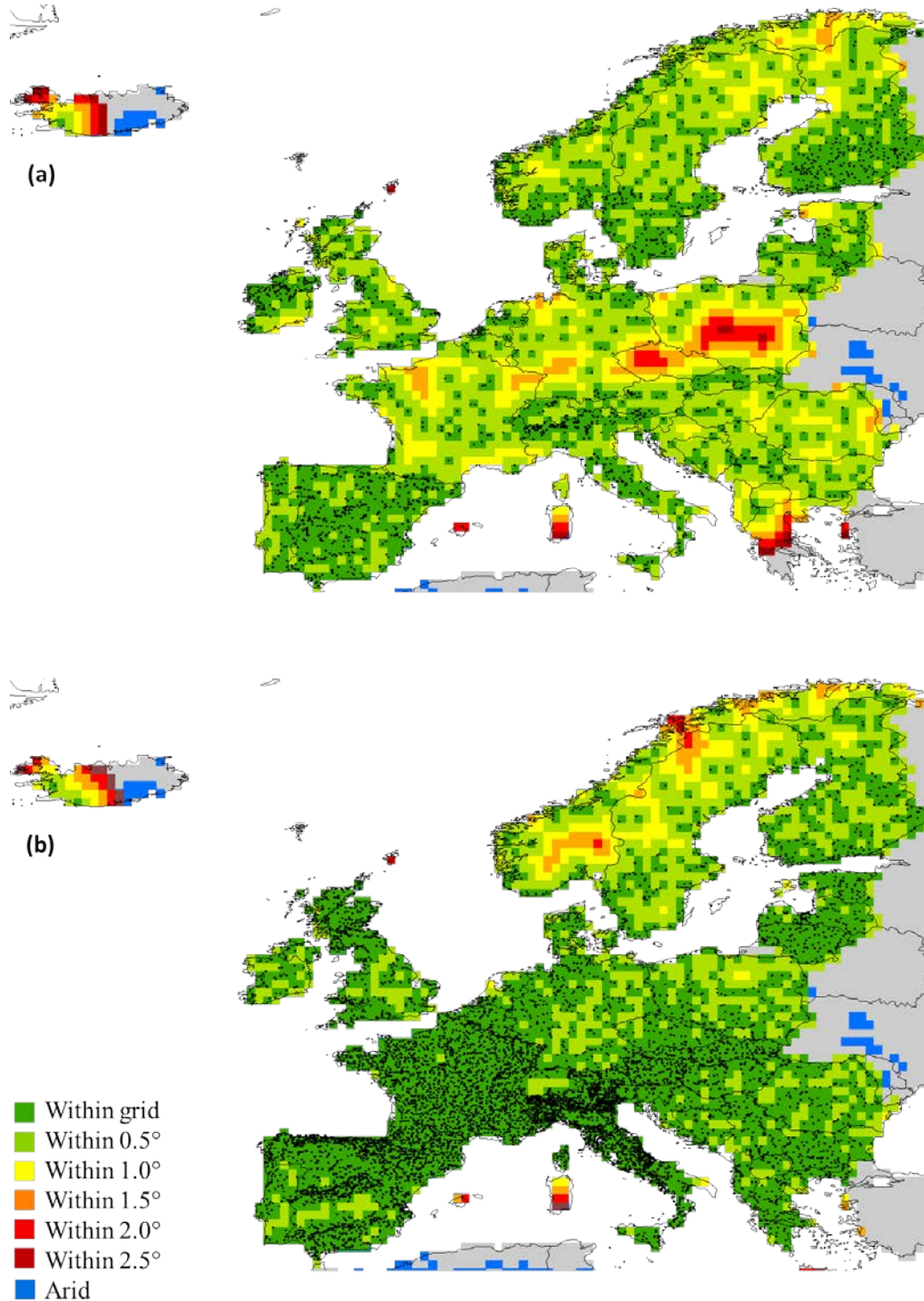
<b>Ecoregion as defined by Abell and colleagues (2008)</b>	<b>Original MTH name as defined by FEOW</b>	<b>Region</b>
Volta	tropical and subtropical floodplain rivers and wet	(sub)tropical
West Florida Gulf	temperate coastal rivers	temperate
West Texas Gulf	tropical and subtropical coastal rivers	(sub)tropical
Western Amazon Piedmont	montane freshwaters	cold
Western Anatolia	temperate coastal rivers	temperate
Western Caspian Drainages	montane freshwaters	cold
Western Equatorial Crater Lakes	montane freshwaters	cold
Western Ghats	tropical and subtropical coastal rivers	(sub)tropical
Western Hudson Bay	polar freshwaters	cold
Western Iberia	temperate coastal rivers	temperate
Western Madagascar	xeric freshwaters and endorheic (closed) basins	xeric
Western Mongolia	xeric freshwaters and endorheic (closed) basins	xeric
Western Orange	xeric freshwaters and endorheic (closed) basins	xeric
Western Red Sea Drainages	xeric freshwaters and endorheic (closed) basins	xeric
Western Taiwan	tropical and subtropical coastal rivers	(sub)tropical
Western Transcaucasia	temperate coastal rivers	temperate
Xi Yiang	tropical and subtropical floodplain rivers and wet	(sub)tropical
Xingu	tropical and subtropical upland rivers	(sub)tropical
Yaghistan	montane freshwaters	cold
Yenisei	polar freshwaters	cold
Yucatan	tropical and subtropical coastal rivers	(sub)tropical
Zambeian Headwaters	tropical and subtropical upland rivers	(sub)tropical
Zambeian Highveld	tropical and subtropical upland rivers	(sub)tropical
Zambeian Lowveld	tropical and subtropical coastal rivers	(sub)tropical

\* Ecoregions that belong to the large lakes or large river deltas MHT classes were manually allocated to one of the four new habitats based on their geographical location. All ecoregions that belong to the Oceanic Islands MHT were allocated to the (sub)tropical habitat.

## Appendix 2-II: Environmental concentration data

Given the few mean annual TP data available outside Europe, we limited the analysis of the effect factors (EF) which required the concentration of P as an input parameter to the European continent. We included the latest mean annual TP record at each monitored station reported by the European Environment Agency ([www.eea.europa.eu](http://www.eea.europa.eu)) up to January 2013. The locations of the monitoring stations reporting mean annual TP data are shown in Figure 2.4. In a second step, we determined the concentration of P in each  $0.5^\circ \times 0.5^\circ$  grid in Europe as TP as the mean average of the TP concentrations of the monitoring stations for lakes and streams separately. For grids where no monitoring station was present, we used the mean average of the TP concentrations in the monitoring stations within a  $0.5^\circ$  distance from the grid. For grids where no monitoring station was present within a  $0.5^\circ$  distance, we used the monitoring stations within a  $1.0^\circ$  distance, and so on, until all continental European grids were given a TP concentration estimate. Finally, we determined the concentration of TP in freshwater  $w$  in grid  $j$  ( $C_{w,j}$ ) as the mean of the individual annual mean TP concentrations in monitored lake or stream stations within  $j$ .





**Figure 2.4:** Distance from grids to their nearest (a) lake (n = 2375) and (b) stream (n = 9194) monitoring station (dots) in Europe. The percentage of grids comprising a lake monitoring station within the grid and within 0.5°, 1.0°, 1.5°, 2.0°, and 2.5°, respectively, is 32.14, 43.45, 12.43, 3.50, 1.55, and 0.64. The percentage of grids comprising a stream monitoring station within the grid and within 0.5°, 1.0°, 1.5°, 2.0°, and 2.5°, respectively are 60.16, 26.56, 4.87, 2.01, 0.67, and 0.25.

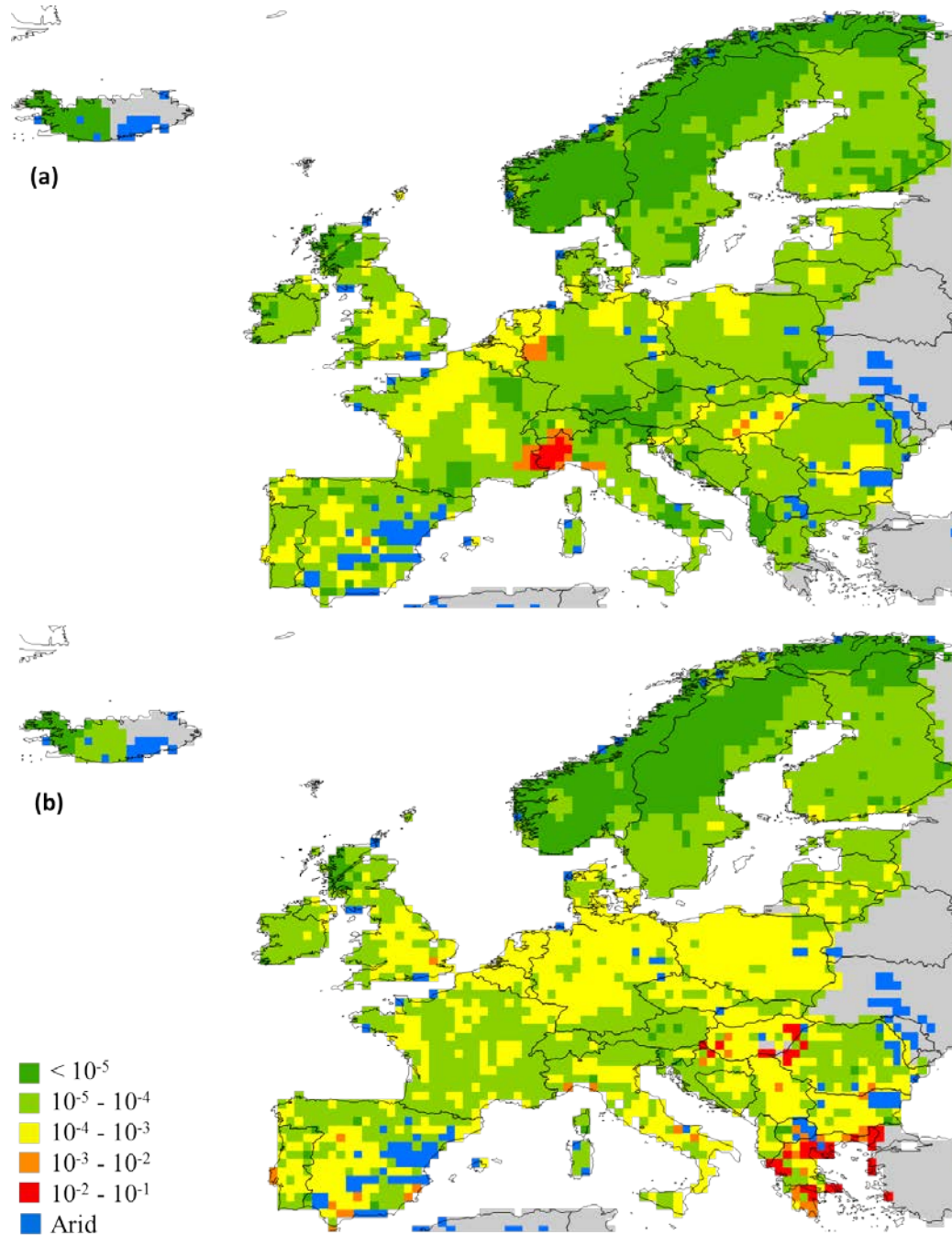
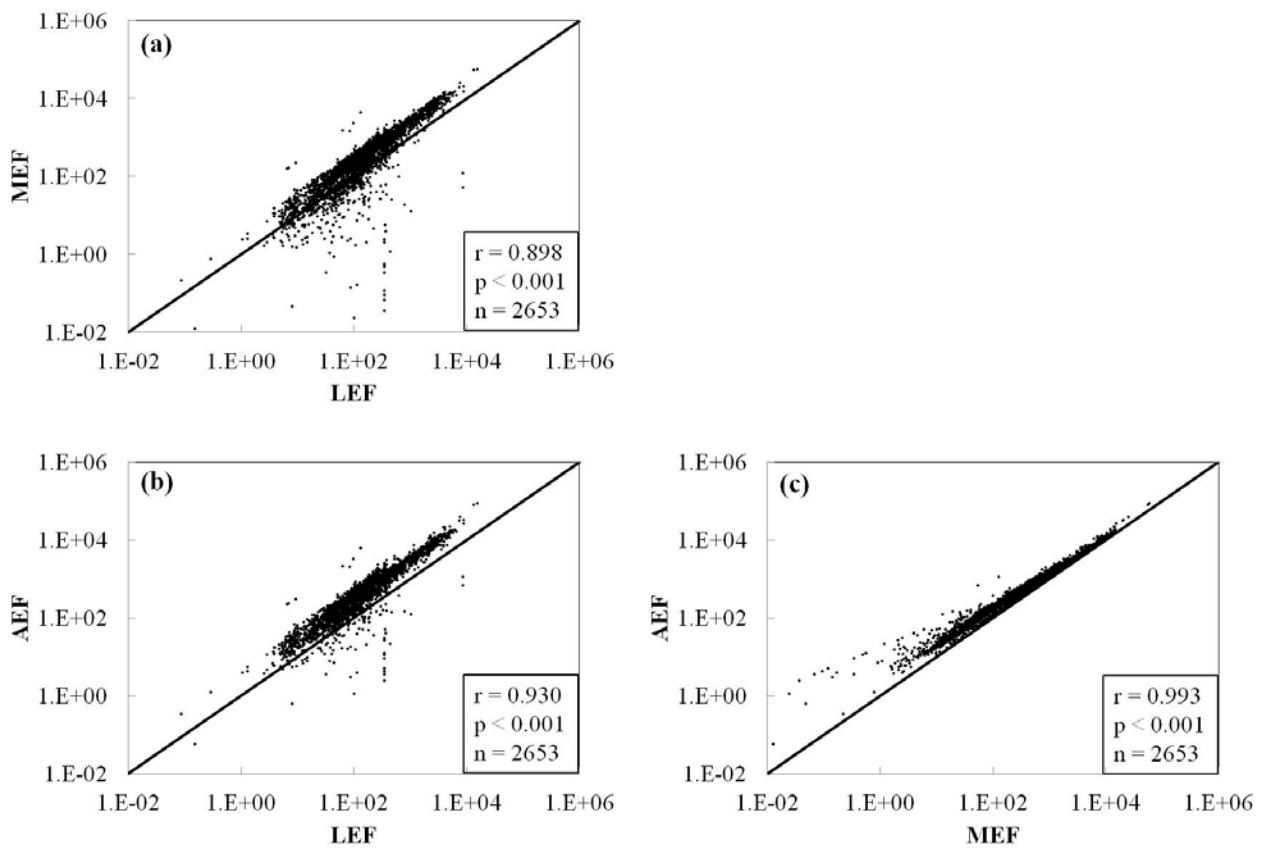


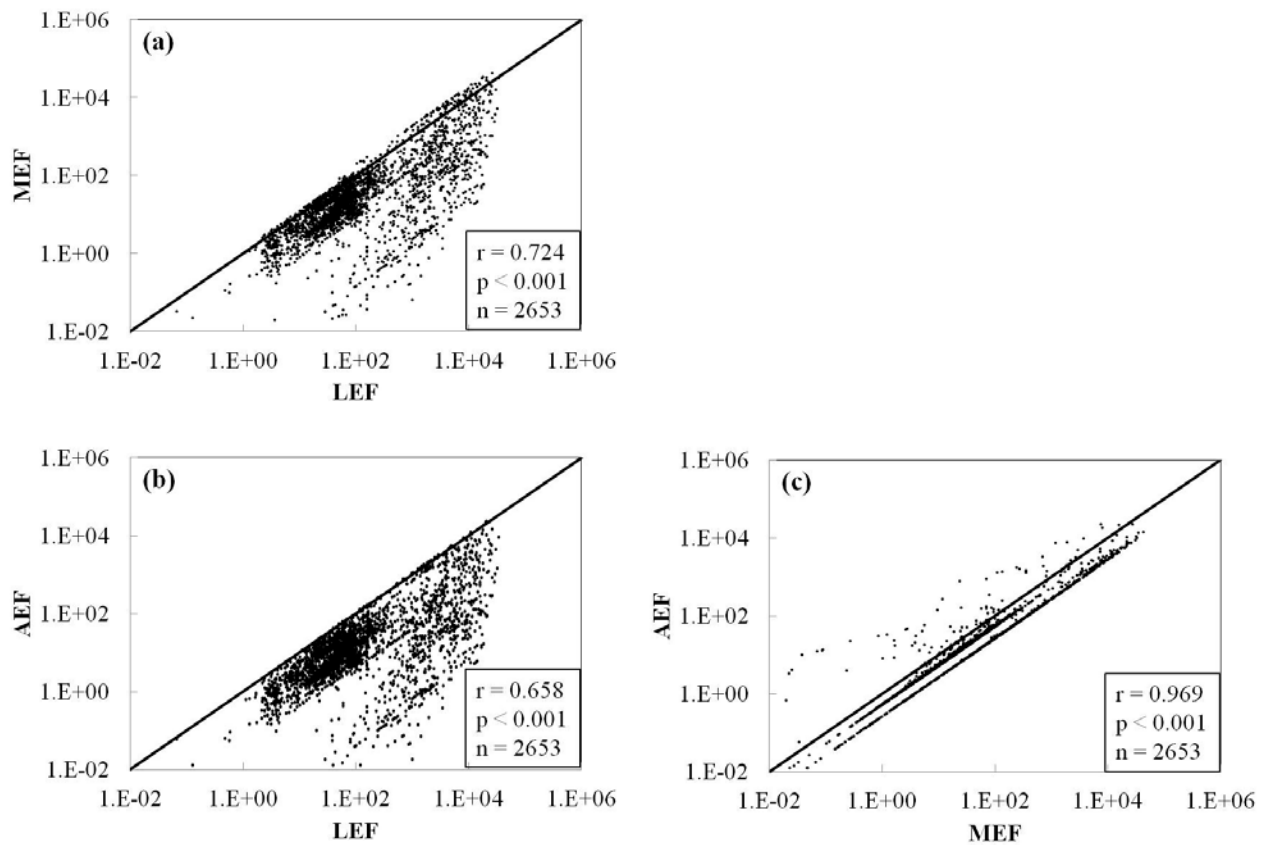
Figure 2.5: Concentrations of mean annual TP,  $C_{w,j}$  ( $\text{kg P}\cdot\text{m}^{-3}$ ), for (a) lakes and (b) streams in Europe.

## **Appendix 2-III: Comparison between characterisation factors types for lake heterotrophs and stream autotrophs and heterotrophs**

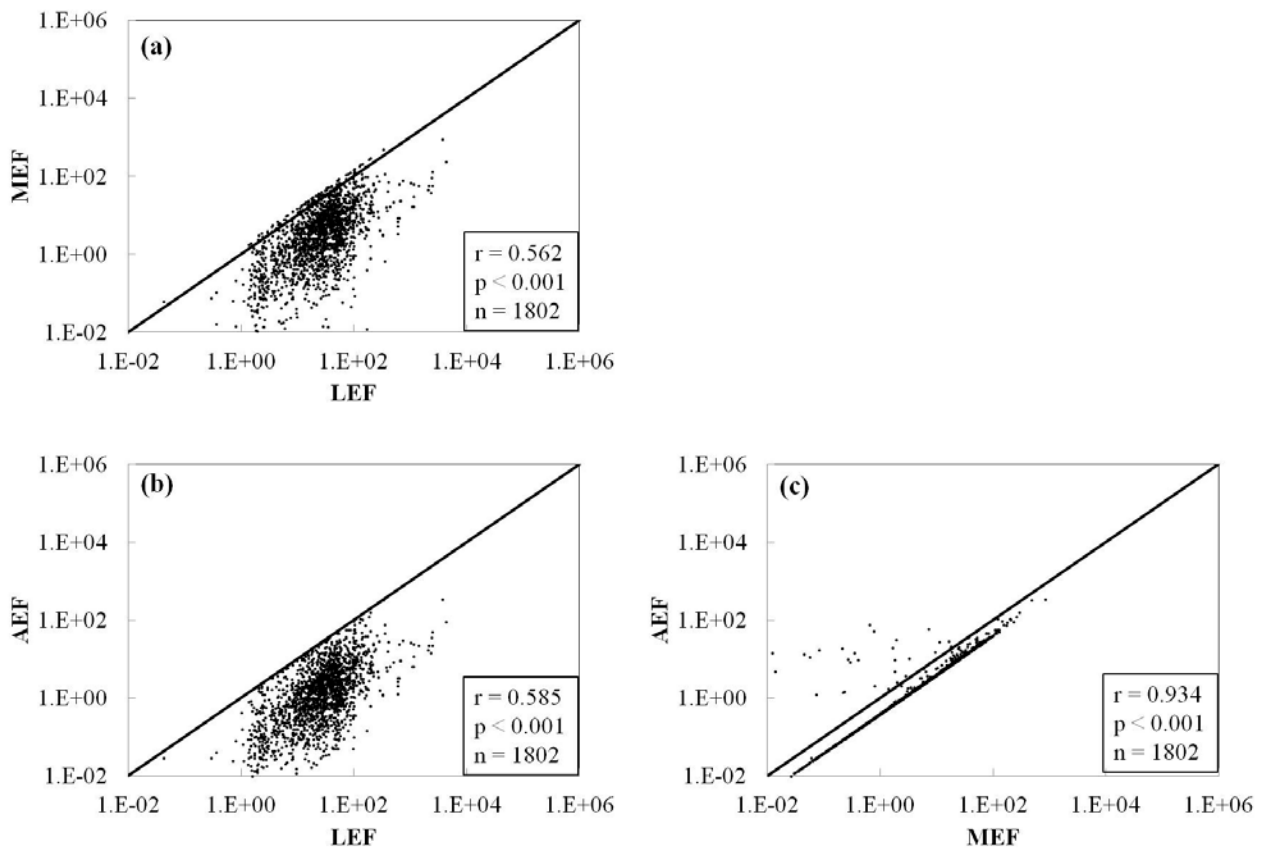
The results of the Pearson correlation between the CFs derived by the linear (*LEF*), marginal (*MEF*), and average (*AEF*) effect factors for lake autotrophs, lake heterotrophs and stream autotrophs are shown in Figure 2.6: **Comparison between characterisation factors (CFs) based on the linear (LEF), marginal (MEF), and average (AEF) effect factors in each emitting grid for lake autotrophs. The Pearson correlation coefficient (r), p value, and number of samples (n) is shown in the bottom right corner.** Figure 2.6, Figure 2.7, and Figure 2.8, respectively. The ratio between the CFs results based on the three effect factor types are shown in Figure 2.9, Figure 2.10, and Figure 2.11, respectively. The Pearson correlation results for stream heterotrophs can be found in Figure 2.3 of the main text and the cumulated difference for this organism and freshwater group is shown in Figure 2.12 of this appendix.



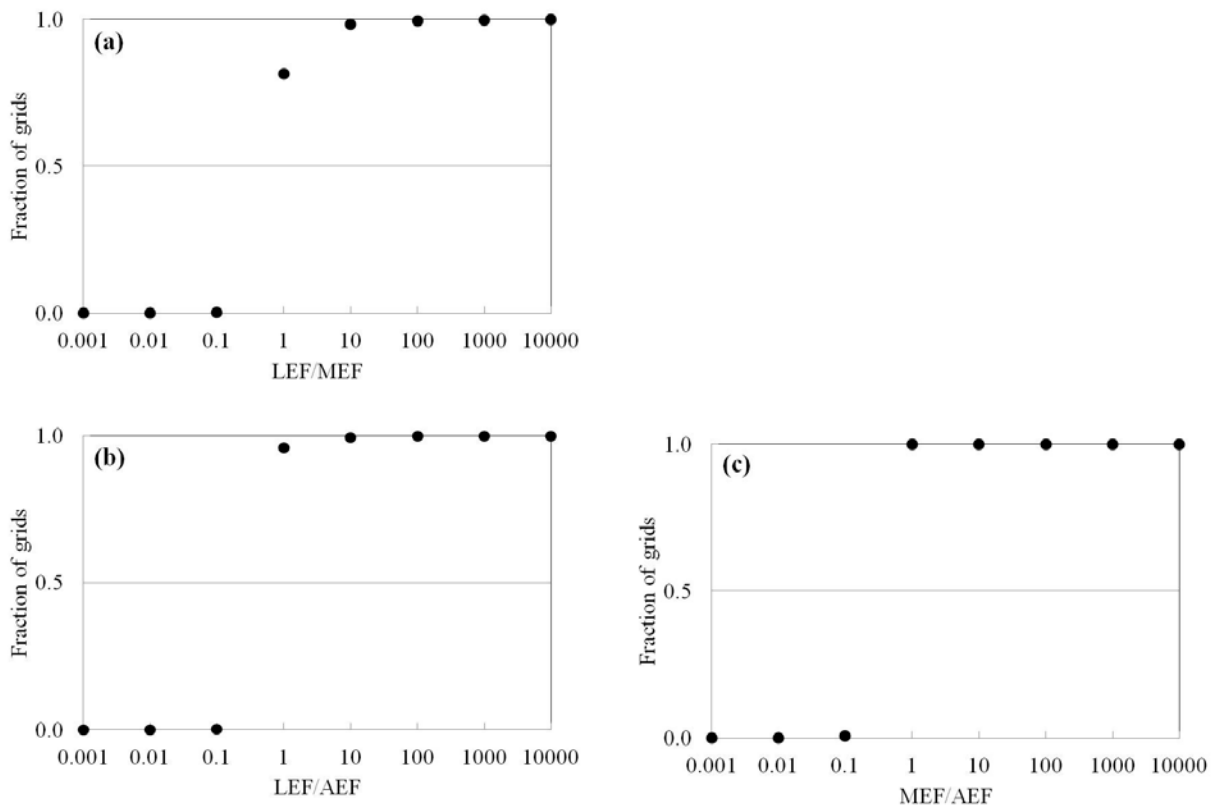
**Figure 2.6:** Comparison between characterisation factors (CFs) based on the linear (*LEF*), marginal (*MEF*), and average (*AEF*) effect factors in each emitting grid for lake autotrophs. The pearson correlation coefficient ( $r$ ),  $p$  value, and number of samples ( $n$ ) is shown in the bottom right corner.



**Figure 2.7:** Comparison between characterisation factors (CFs) based on the linear (**LEF**), marginal (**MEF**), and average (**AEF**) effect factors in each emitting grid for lake heterotrophs. The Pearson correlation coefficient ( $r$ ),  $p$  value, and number of samples ( $n$ ) is shown in the bottom right corner.

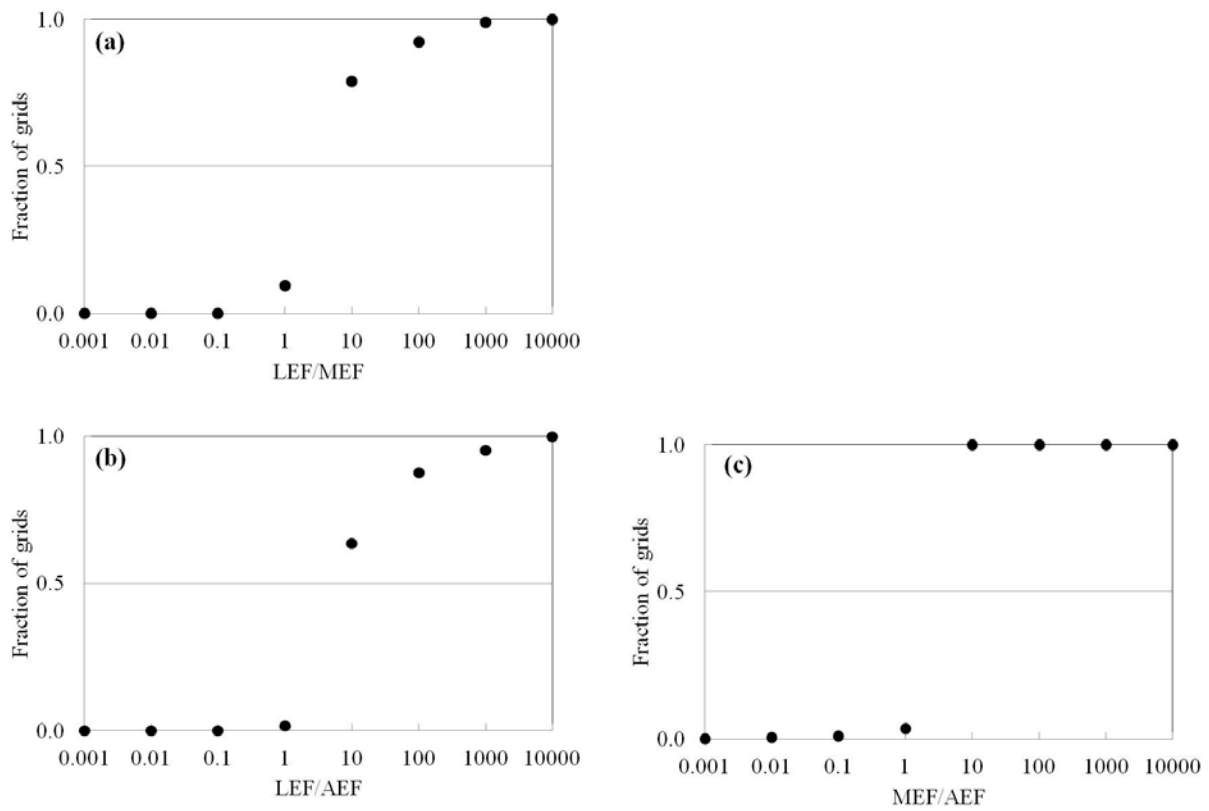


**Figure 2.8:** Comparison between characterisation factors (CFs) based on the linear (*LEF*), marginal (*MEF*), and average (*AEF*) effect factors in each emitting grid for stream autotrophs. The pearson correlation coefficient ( $r$ ),  $p$  value, and number of samples ( $n$ ) is shown in the bottom right corner.



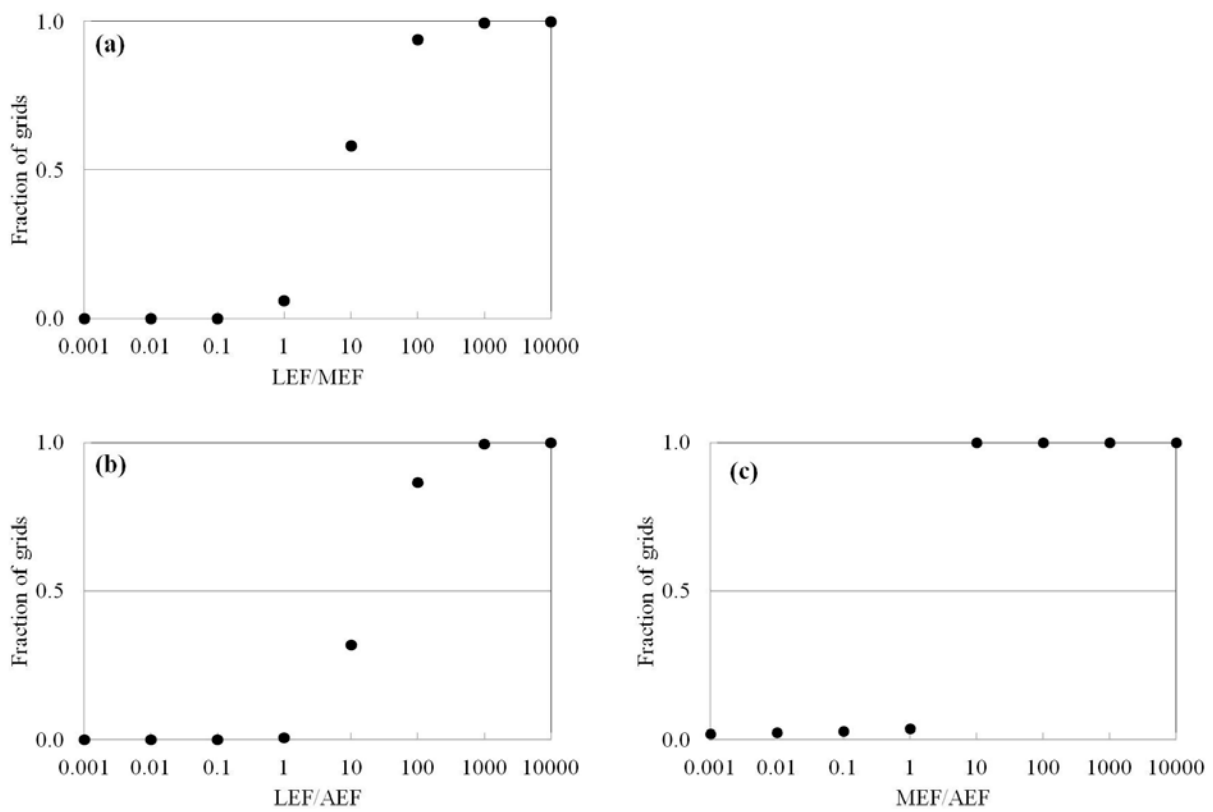
**Figure 2.9:** Cumulative frequency distribution of the ratio between characterisation factors (CFs) based on the linear (*LEF*), marginal (*MEF*), and average (*AEF*) for lake autotrophs.



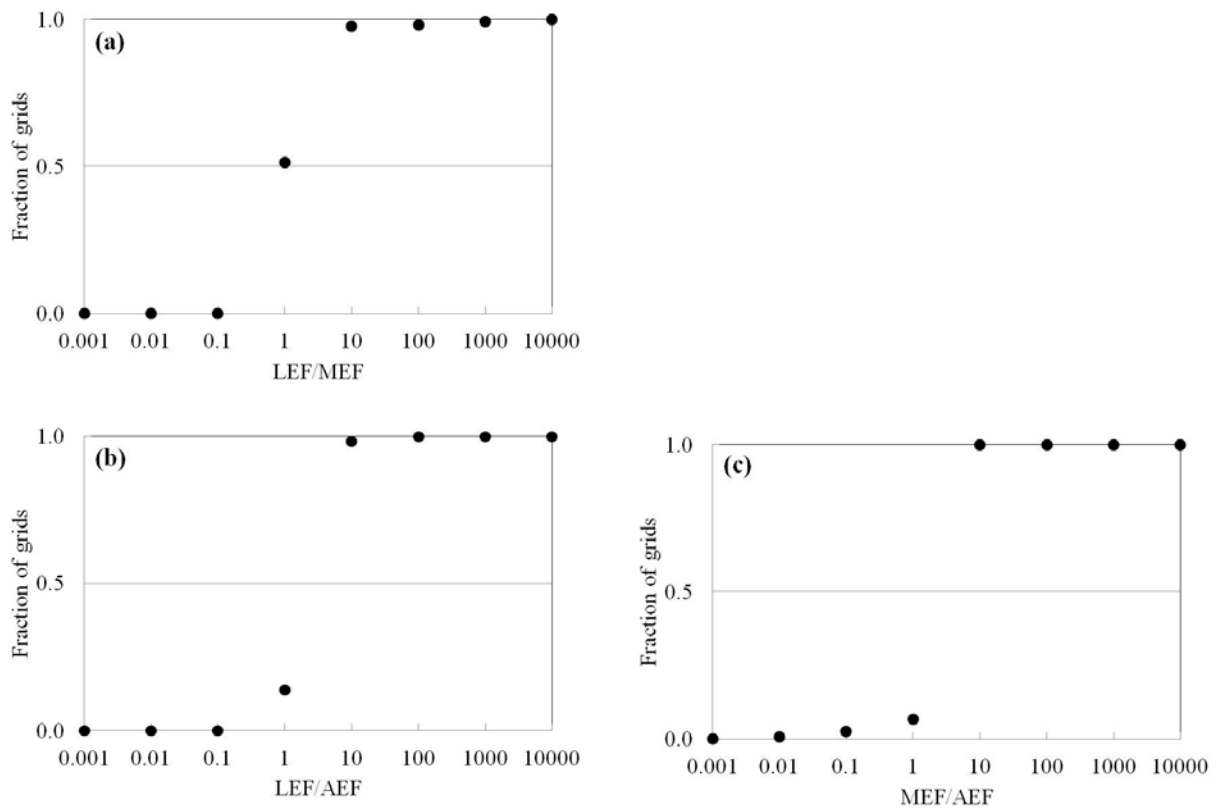


**Figure 2.10:** Cumulative frequency distribution of the ratio between characterisation factors (CFs) based on the linear (*LEF*), marginal (*MEF*), and average (*AEF*) for lake heterotrophs.

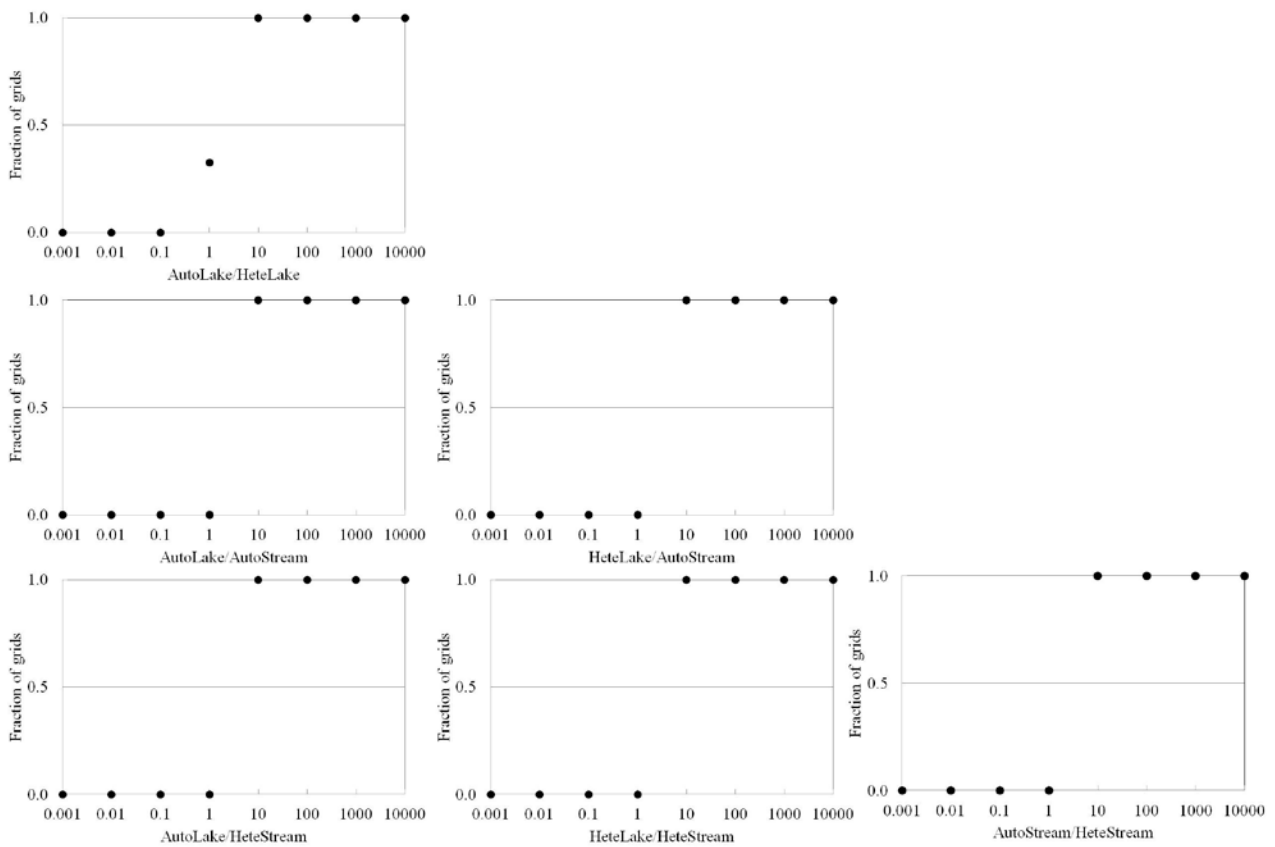




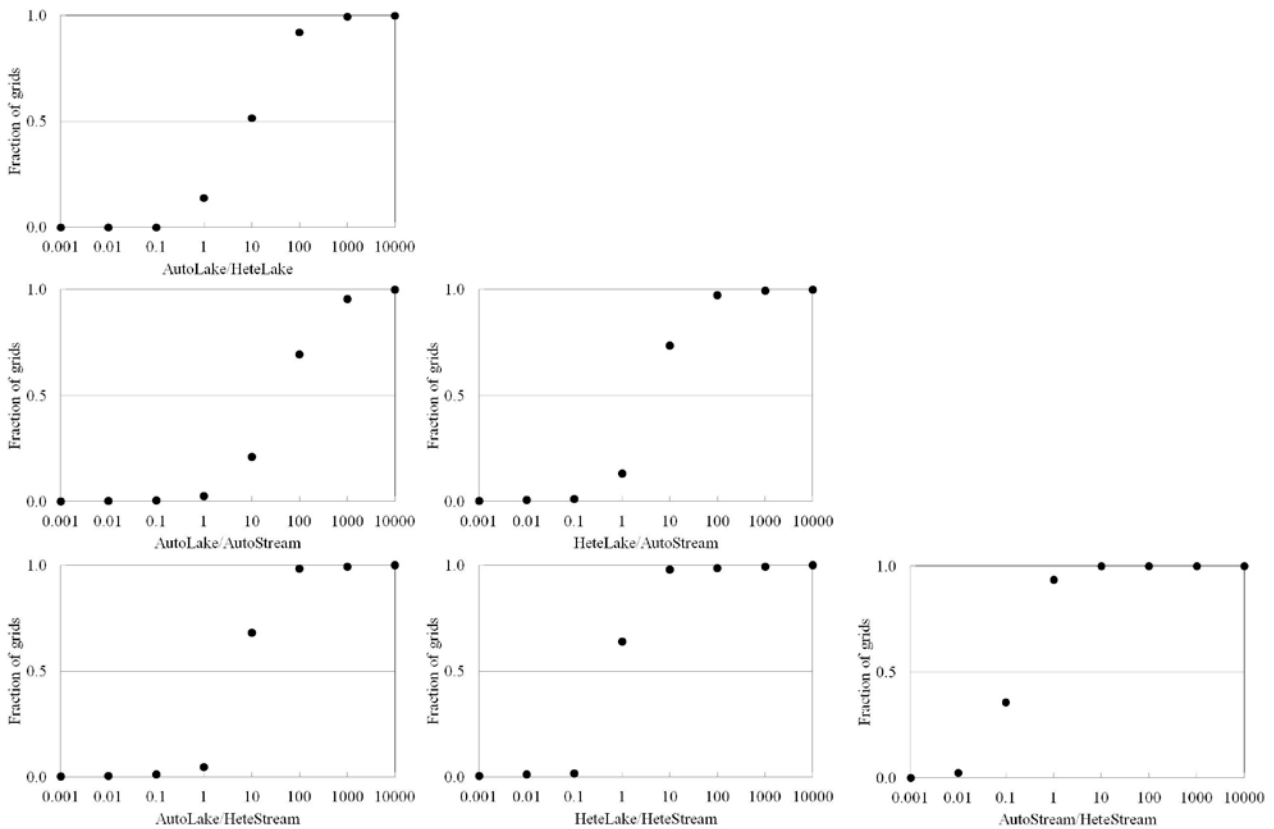
**Figure 2.11:** Cumulative frequency distribution of the ratio between characterisation factors (CFs) based on the linear (*LEF*), marginal (*MEF*), and average (*AEF*) for stream autotrophs.



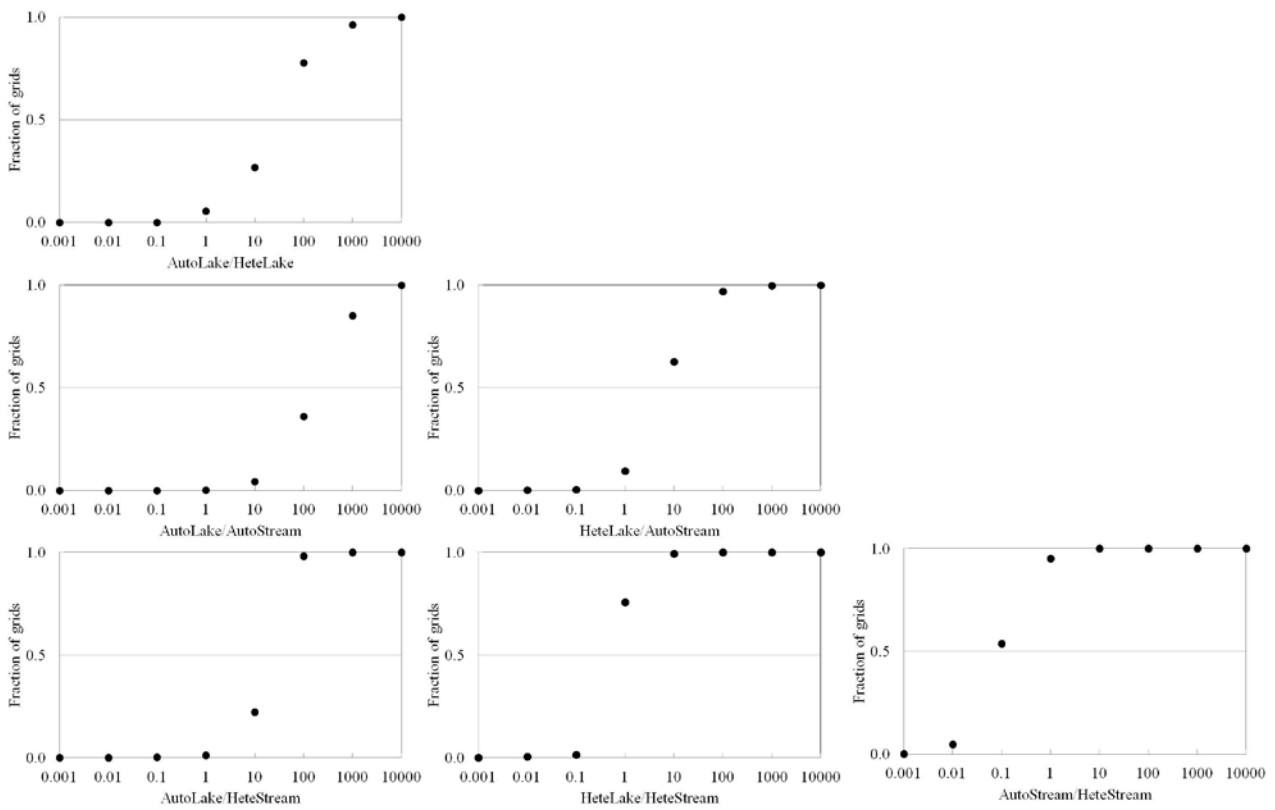
**Figure 2.12:** Cumulative frequency distribution of the ratio between characterisation factors (CFs) based on the linear (*LEF*), marginal (*MEF*), and average (*AEF*) for stream heterotrophs.



**Figure 2.13:** Cumulative frequency distribution of the ratio between characterisation factors of autotrophs in lakes (AutoLake), heterotrophs in lakes (HeteLake), autotrophs in streams (AutoStream), and heterotrophs in streams (HeteStream) based on linear effect factors.



**Figure 2.14:** Cumulative frequency distribution of the ratio between characterisation factors of autotrophs in lakes (AutoLake), heterotrophs in lakes (HeteLake), autotrophs in streams (AutoStream), and heterotrophs in streams (HeteStream) based on marginal effect factors.



**Figure 2.15:** Cumulative frequency distribution of the ratio between characterisation factors of autotrophs in lakes (AutoLake), heterotrophs in lakes (HeteLake), autotrophs in streams (AutoStream), and heterotrophs in streams (HeteStream) based on average effect factors.

## Appendix 2-IV: Grid, country, continent, and world characterisation factors

Grid, country, continent, and world midpoint CF (day) and endpoint CFs ( $\text{day}\cdot\text{kg}^{-1}\cdot\text{m}^3$ ) based on the linear (*LEF*), marginal (*MEF*), and average (*AEF*) effect factors are shown in excel file ‘CF.xlsx’ (see description of dataset in Table 2.3).

**Table 2.3:** Description of the worksheets in the CF excel table.

Worksheet name	Description
GridMidCF	Grid-specific midpoint CF
GridEndCF	Grid-specific endpoint CF
CountryMidCF	Country-specific midpoint CF
CountryEndCF	Country -specific endpoint CF
ContinentMidCF	Continent-specific midpoint CF
ContinentEndCF	Continent -specific endpoint CF
WorldMidCF	World midpoint CF
WorldEndCF	World endpoint CF
Readme	Details of the excel document

## Appendix 2-V: Grid, country, continent, and world emission estimates

Grid, country, continent, and world emission estimates point-sources  $S_{Sew}$  ( $\text{kgP}\cdot\text{person}^{-1}\cdot\text{yr}^{-1}$ ) (from human sewage and laundry and dishwasher detergent) are shown in excel file ‘Sewage.xlsx’ (see description of dataset in Table 2.4). Grid, country, continent, and world emission estimates non-point-sources from manure fertilizer are shown in excel file ‘ManureFertilizer.xlsx’ (see description of dataset in Table 2.5). Grid, country, continent, and world emission estimates non-point-sources from synthetic fertilizer are shown in excel file ‘SyntheticFertilizer.xlsx’ (see description of dataset in Table 2.6).

**Table 2.4:** Description of the worksheets in the ‘Sewage.xlsx’ file.

Worksheet name	Description
EmissionGrid	Grid-specific emissions
EmissionCountry	Country-specific emissions
EmissionContinent	Continent-specific emissions
EmissionWorld	World emissions

**Table 2.5:** Description of the worksheets in the ‘ManureFertilizer.xlsx’ file.

Worksheet name	Description
EmissionGrid	Grid-specific emissions
EmissionCountry	Country-specific emissions
EmissionContinent	Continent-specific emissions
EmissionWorld	World emissions

**Table 2.6:** Description of the worksheets in the ‘SyntheticFertilizer.xlsx’ file.

Worksheet name	Description
EmissionGrid	Grid-specific emissions
EmissionCountry	Country-specific emissions
EmissionContinent	Continent-specific emissions
EmissionWorld	World emissions

## Appendix 2-VI: Grid, country, continent, and world normalization factors

Grid, country, continent, and world normalization factors NS estimates point-sources (from human sewage and laundry and dishwasher detergent) as shown in excel file 'NS.xlsx' (see description of dataset in Table 2.7).

**Table 2.7:** Description of the worksheets in the 'NS.xlsx' file.

Worksheet name	Description
GridMidNS	Grid-specific midpoint NS
GridEndNS	Grid-specific endpoint NS
CountryMidNS	Country-specific midpoint NS
CountryEndNS	Country -specific endpoint NS
ContinentMidNS	Continent-specific midpoint NS
ContinentEndNS	Continent -specific endpoint NS
WorldMidNS	World midpoint NS
WorldEndNS	World endpoint NS
Readme	Details of the excel document



## 2.8 References for freshwater eutrophication

Abell, R., Thieme, M.L., Revenga, C., Bryer, M., Kottelat, M., Bogutskaya, N., Coad, B., Mandrak, N., Balderas, S.C., Bussing, W., Stiassny, M.L.J., Skelton, P., Allen, G.R., Unmack, P., Naseka, A., Ng, R., Sindorf, N., Robertson, J., Armijo, E., Higgins, J.V., Heibel, T.J., Wikramanayake, E., Olson, D., Lopez, H.L., Reis, R.E., Lundberg, J.G., Perez, M.H.S., Petry, P., 2008. Freshwater ecoregions of the world: A new map of biogeographic units for freshwater biodiversity conservation. *Bioscience* 58, 403-414.

Amarasinghe, U.S., Welcomme, R.L., 2002. An analysis of fish species richness in natural lakes. *Environmental Biology of Fishes* 65, 327-339.

Azevedo, L.A., Van Zelm, R., Elshout, P.M.F., Hendriks, A.J., Leuven, R.S.E.W., Struijs, J., de Zwart, D., Huijbregts, M.A.J., In Press. Species richness – phosphorus relationships for lakes and streams worldwide. *Global Ecology and Biogeography*.

Björklund, G., Burke, J., Foster, S., Rast, W., Vallée, D., van der Hoek, W., 2009. 3<sup>rd</sup> UN World Water Development Report: Water in a Changing World (WWDR-3). Chapter 8: Impacts of water use on water systems and the environment, in: UNESCO (Ed.). *UN World Water Assessment Programme*, p. 432.

Bouwman, A.F., Beusen, A.H.W., Billen, G., 2009. Human alteration of the global nitrogen and phosphorus soil balances for the period 1970-2050. *Global Biogeochemical Cycles* 23, 16.

Carpenter, S.R., Cole, J.J., Hodgson, J.R., Kitchell, J.F., Pace, M.L., Bade, D., Cottingham, K.L., Essington, T.E., Houser, J.N., Schindler, D.E., 2001. Trophic cascades, nutrients, and lake productivity: whole-lake experiments. *Ecological Monographs* 71, 163-186.

CIESIN, CIAT, 2005. Center for International Earth Science Information Network (CIESIN)/Columbia University, and Centro Internacional de Agricultura Tropical (CIAT). *Gridded Population of the World, Version 3 (GPWv3): Population Density Grid*. Palisades, NY: NASA Socioeconomic Data and Applications Center (SEDAC).

<http://sedac.ciesin.columbia.edu/data/set/gpw-v3-population-density>. Accessed March 12th, 2013.

Curran, M., de Baan, L., De Schryver, A.M., van Zelm, R., Hellweg, S., Koellner, T., Sonnemann, G., Huijbregts, M.A.J., 2010. Toward Meaningful End Points of Biodiversity in Life Cycle Assessment. *Environmental Science & Technology* 45, 70-79.

Helmes, R.J.K., Huijbregts, M.A.J., Henderson, A.D., Jolliet, O., 2012. Spatially explicit fate factors of phosphorous emissions to freshwater at the global scale. *International Journal of Life Cycle Assessment* 17, 646-654.

Huijbregts, M.A.J., Hellweg, S., Hertwich, E., 2011. Do We Need a Paradigm Shift in Life Cycle Impact Assessment? *Environmental Science & Technology* 45, 3833-3834.

Lenat, D.R., Resh, V.H., 2001. Taxonomy and stream ecology - The benefits of genus- and species-level identifications. *Journal of the North American Benthological Society* 20, 287-298.

Liu, Y., Villalba, G., Ayres, R.U., Schroder, H., 2008. Global phosphorus flows and environmental impacts from a consumption perspective. *Journal of Industrial Ecology* 12, 229-247.

Nour, M.H., Smith, D.W., El-Din, M.G., Prepas, E.E., 2006. Neural networks modelling of streamflow, phosphorus, and suspended solids: application to the Canadian Boreal forest. *Water Science and Technology* 53, 91-99.

Payet, J., 2006. Report Describing a Method for the Quantification of Impacts on Aquatic Freshwater Ecosystems Resulting from Different Stressors (e.g., Toxic Substances, Eutrophication,

Etc). Novel Methods for Integrated Risk Assessment of Cumulative Stressors in Europe (NOMIRACLE). École Polytechnique Fédérale de Lausanne.

<http://nomiracle.jrc.ec.europa.eu/webapp/ViewPublicDeliverables.aspx>.

Pennington, D.W., Payet, J., Hauschild, M., 2004. Aquatic ecotoxicological indicators in life-cycle assessment. *Environmental Toxicology and Chemistry* 23, 1796-1807.

Posch, M., Aherne, J., Forsius, M., Rask, M., 2012. Past, Present, and Future Exceedance of Critical Loads of Acidity for Surface Waters in Finland. *Environmental Science & Technology* 46, 4507-4514.

Potter, P., Ramankutty, N., Bennett, E.M., Donner, S.D., 2011. Global Fertilizer and Manure, Version 1: Phosphorus in Manure Production. Palisades, NY: NASA Socioeconomic Data and Applications Center (SEDAC). <http://sedac.ciesin.columbia.edu/data/set/ferman-v1-phosphorus-in-manure-production>. Accessed March 12th, 2013.

Rosenbaum, R.K., Bachmann, T.M., Gold, L.S., Huijbregts, M.A.J., Jolliet, O., Juraske, R., Koehler, A., Larsen, H.F., MacLeod, M., Margni, M., McKone, T.E., Payet, J., Schuhmacher, M., van de Meent, D., Hauschild, M.Z., 2008. USEtox-the UNEP-SETAC toxicity model: recommended characterisation factors for human toxicity and freshwater ecotoxicity in life cycle impact assessment. *International Journal of Life Cycle Assessment* 13, 532-546.

Sattari, S.Z., Bouwman, A.F., Giller, K.E., van Ittersum, M.K., 2012. Residual soil phosphorus as the missing piece in the global phosphorus crisis puzzle. *Proceedings of the National Academy of Sciences of the United States of America* 109, 6348-6353.

Schindler, D.W., 1977. Evolution of phosphorus limitation in lakes. *Science* 195, 260-262.

Seppälä, J., Knuutila, S., Silvo, K., 2004. Eutrophication of aquatic ecosystems - A new method for calculating the potential contributions of nitrogen and phosphorus. *International Journal of Life Cycle Assessment* 9, 90-100.

Struijs, J., Beusen, A., de Zwart, D., Huijbregts, M., 2011a. Characterization factors for inland water eutrophication at the damage level in life cycle impact assessment. *International Journal of Life Cycle Assessment* 16, 59-64.

Struijs, J., De Zwart, D., Posthuma, L., Leuven, R.S.E.W., Huijbregts, M.A.J., 2011b. Field sensitivity distribution of macroinvertebrates for phosphorus in inland waters. *Integrated Environmental Assessment and Management* 7, 280-286.

Udo de Haes, H.A., Finnveden, G., Goedkoop, M., Hauschild, M., Hertwich, E., Hofstetter, P., Jolliet, O., Klöpffer, W., Krewitt, W., Lindeijer, E., Müller-Wenk, R., Olsen, S.I., Pennington, D.W., Potting, J., Steen, B., 2002. *Life Cycle Impact Assessment: Striving towards best practice*. SETAC Press, 2002, Pensacola, Florida.

Van de Meent, D., Huijbregts, M.A.J., 2005. Calculating life-cycle assessment effect factors from potentially affected fraction-based ecotoxicological response functions. *Environmental Toxicology and Chemistry* 24, 1573-1578.

Van Drecht, G., Bouwman, A.F., Harrison, J., Knoop, J.M., 2009. Global nitrogen and phosphate in urban wastewater for the period 1970 to 2050. *Global Biogeochem. Cycles* 23, GB0A03.

van Zelm, R., Huijbregts, M.A.J., Van Jaarsveld, H.A., Reinds, G.J., De Zwart, D., Struijs, J., Van de Meent, D., 2007. Time horizon dependent characterization factors for acidification in life-cycle assessment based on forest plant species occurrence in Europe. *Environmental Science & Technology* 41, 922-927.

### 3. SPATIALLY-EXPLICIT CHARACTERISATION FACTORS FOR MARINE EUTROPHICATION

*Nuno Cosme\*, Henrik Fred Larsen, Michael Zwicky Hauschild*

Division for Quantitative Sustainability Assessment (QSA), Department of Management Engineering (DTU-MAN), Technical University of Denmark (DTU), Building 426, 2800 Kgs. Lyngby, Denmark

\*Corresponding author:

Nuno Cosme; Tel: +45 45 25 47 29; Fax: +45 45 93 34 35; e-mail: nmhc@dtu.dk

#### **Abstract**

Marine eutrophication processes include the excessive growth of phytoplankton biomass in response to increased availability of nitrogen (N) in the photic zone of marine coastal waters. The eventual degradation of this biomass results in oxygen consumption in bottom waters by bacterial respiration. The excessive depletion of dissolved oxygen (DO) poses a potential impact to ecology, economy, and water quality. Land based human interventions are increasing the N loadings to marine coastal systems and overrunning their natural capacity to absorb N. Life Cycle Impact Assessment (LCIA) methodologies have been developed to assess and comparatively quantify the potential environmental impacts in different categories. Marine eutrophication is still lacking a sound methodology to link midpoint and endpoint indicators and an overall model to assess the potential impact of the over-enrichment of marine ecosystems by N. A model was built for the estimation of endpoint CF for marine eutrophication: Fate Factors (FF) were estimated for both airborne and waterborne N emissions based on modelling of river-N and marine-N losses to deliver the midpoint category indicator (i.e. increase of N in the marine compartment); Exposure Factors (XF) were estimated based on incorporation of N into biomass in the photic zone to DO consumption in the benthic habitat. Finally, Effect Factors (EF) were estimated by applying the statistical Distribution of the Species Sensitivity (SSD) to hypoxia delivering the endpoint category indicator (i.e. species diversity loss). The product of the three factors, FF·XF·EF delivers the CF with the desired damage dimension, i.e. (PAF·)[m<sup>3</sup>·d/kg], to be applied to the emitted amount of N [kg] from Life Cycle Inventory (LCI). The model provides CFs for the “N to air”, “N to surface freshwater”, “N to groundwater”, and “N to marine water” LCI flows for 214 country-to-LME (Large Marine Ecosystems), 143 countries, 13 regions/continents, and a global default. The sensitivity and uncertainty analyses identified key issues for data quality improvement, namely Primary Production (PP) datasets, residence time, and N-export splitting rules for multiple receiving ecosystems. Further improvements point to the inclusion of spatial differentiation to the N-losses within the fate models.

## 3.1 Introduction

### 3.1.1 Background

Life Cycle Assessment (LCA) has been dealing with the environmental performance of products and services throughout their life cycle (Hauschild 2005; Curran et al. 2011). However, accounting for all the resulting environmental impacts has not been covered in full extent. Impact assessment methodology is still lacking for several of the impact categories, including eutrophication (Huijbregts 2011).

It is widely acknowledged that marine eutrophication involves natural processes leading to an excessive growth of algal biomass in response to nutrient enrichment of marine systems. Once the plant nutrients, mainly nitrogen (N) are available to assimilation and growth, the excessive biomass produced can decrease the water quality (along with the degradation of organic matter from other sources) and bring undesirable effects to biological communities both in the water column and at the bottom (OSPAR 2008). While being true this broad definition falls short in addressing the sources, processes, and effects involved.

Kitsiou & Karydis (2011) compiled a comprehensive historical evolution of the definition of marine eutrophication. In broad terms, this evolution started early in 1919 when Naumann focused on the increase of phosphorous and nitrogen in lake systems (cited in Hutchinson 1967), later extended to “*any and all nutritive substances*” (Hasler 1947, p. 383). As the marine eutrophication processes were being studied and knowledge expanded, the definition also evolved to include the algal growth in response to the increase of nutrients in the marine environment as well as introducing the idea of its immediate consequences (Steele 1974). The inclusion of the impacts in the definition was proposed by Vollenweider (1992, p. 3) by referring to algal blooms in response to “*the process of enrichment of waters with plant nutrients, primarily nitrogen and phosphorus that stimulates aquatic primary production*”. At the same time, Gray (1992) pursued the photosynthesis concept and nutrients loadings as a source provided that the nutrients are not toxic compounds. Nixon (1995, p. 201) then defined marine eutrophication as a process, instead of a trophic state, and introduced the organic matter concept when proposing his short definition: “*Eutrophication is an increase in the rate of supply of organic matter to an ecosystem*”. Sharing the same considerations, Heip (1995) included the impacts elsewhere, namely in the benthos, by expanding the nutrients loadings and productivity to include the indirect impacts of oxygen depletion and ecological changes (species composition and interaction).

The above definitions were developed in a scientific perspective. International official entities have further contributed with practical and assertive definitions:

- The European Environmental Agency (EEA) directed the concept to anthropogenic causes: “*Eutrophication means enhanced primary production due to excess supply of nutrients from human activities, independent of the natural productivity level for the area in question*” (EEA 2001, p. 8);
- The European Council focused on compounds of nitrogen and phosphorous as the cause for the “*accelerated growth of algae and higher forms of plant life to produce an undesirable disturbance to the balance of organisms present in the water and to the quality of the water concerned*” (EC 1991, p. 41). The novelty was the ‘disturbance’ perspective and the need for management of these nutrients in sewage treatment;

- The UNEP (2003), agreeing with the historical development of the concept, introduced the 'excess' term over 'increase' when referring to the nutrients availability and the system's natural thresholds by mentioning that the cause is "*the load of nutrients (...) from human activities in quantity exceeding the carrying capacity of the receiving environment*" (UNEP, 2003, 2) while recognizing Nixon's concept and generalizing it with: "*caused by an excess rate of supply of organic matter, including excessive primary production*" (EEA 1999, p. 16; UNEP 2003, p. 1).

### 3.1.2 Eutrophication as a function of nutrients or organic matter enrichment?

Despite the effort in finding a clear operational definition for eutrophication over the years, the concept is used in a blurry way by scientists and managers (Nixon & Fulweiler 2009).

As seen above, the concept of marine eutrophication has evolved into two major mindsets (although intertwined) – the one based on the nutrients loadings signalling primary productivity, and the other based on the degradation of organic matter. While both share the rationale of the biological processes and interesting topics for discussion, the nutrients approach seems to be restricting the sources of organic matter to the degradation of the newly produced biomass (autochthonous, i.e. locally produced biomass from non-anthropogenic available nutrients) resulting from the addition of nutrients to a nutrient-limited system. Indeed, marine eutrophication has its roots in the nutrients loadings and their limiting availability in dictating plant biomass growth and thus carbon fixation. However, the regeneration and recycling of nutrients and its accountability to the biomass production is not mentioned. This has been addressed and worked upon both in the scientific and regulatory frameworks resulting in contributions to understand, mitigate, and manage the processes and results.

On its turn, Nixon's proposed definition directs focus to organic matter in the ecosystem, in the sense that it is a result from a dynamic process, from sources (fate) to effects. It also reminds that nutrients enrichment is not the only cause of eutrophication (although the most common) and that organic matter can be autochthonous but also allochthonous (organic loads from outside the ecosystem, like sewage water and industrial wastes for instance), thus better reflecting the fate dynamics (Nixon 2009). Moreover, this approach skips the considerations about regeneration and recycling of nutrients by focusing on a single parameter on the net result of production, i.e. biomass. This simple definition eases the distinction from causes to consequences: the causes are diverse and may include increase in inorganic nutrients inputs or organic matter loadings, decrease in grazing pressure over phytoplankton, alterations on system's dynamics or water residence time, while the consequences may include changes in the ecosystems' populations structure, increased oxygen demand, mass mortalities, harmful algal blooms, and others (Hinga et al. 1995). Finally, Nixon argues that explaining eutrophication as responses to "*nutrients concentrations, chlorophyll levels or species composition confuses symptoms with the underlying phenomenon*" (Nixon 2009, p. 5).

### 3.1.3 Marine productivity and eutrophication

The basis for primary production is the photosynthetic process by phytoplankton. Productivity relates to the system's capacity to utilize available nutrients and generate organic matter by fixating carbon. The main sources of N can be nitrate (the oxidised form) or ammonia and urea

(the reduced forms) that are natural metabolic waste products of respiration (degradation of e.g. amino acids/proteins) supplied internally in the surface mixed layer (Platt & Sathyendranath 2007). Nitrate is externally supplied from deeper waters where OM is remineralized, from terrestrial/freshwater runoff (where the anthropogenic contribution is significant), or in less extent by atmospheric  $N_2$ -fixation.

According to the mentioned sources of N, productivity consists of *new production* ( $P_{new}$ ), which uses nutrients that are supplied externally (allochthonous sources), and *regenerated production* ( $P_r$ ), which uses nutrients that are recycled within the surface mixed layer. The sum of the two components equals *total productivity* ( $P_t$ ). The organic carbon that sinks to the aphotic zone is an *export production* ( $P_E$ ) (Wassmann 1990). This fraction is important because it constitutes a source of organic matter (particulate organic carbon, POC) for bacterial degradation in the bottom layers.

$$P_t = P_{new} + P_r$$

In a steady-state perspective,  $P_r$  is referred as the component of  $P_t$  that meets the metabolic demands of the community of pelagic primary producers. The remaining component ( $P_{new}$ ) is the production that can be used to increase phytoplankton's biomass (Platt & Sathyendranath 1988). This assumption is of key importance to understand the potential effect on phytoplankton populations of the anthropogenic input of N to the marine system and to the "biological pump" responsible for the sink effect for carbon from atmospheric carbon dioxide to deeper waters, thus helping to regulate greenhouse effect and global climate. Again, under the same steady-state assumption, the downward flux of sinking POC is equivalent to  $P_{new}$  (Wassmann 1990; Platt & Sathyendranath 2007).

Eutrophy characterizes the level of productivity of a system, meaning that systems holding high rates of carbon fixation by primary producers into biomass from nutrients and carbon dioxide are known as eutrophic (Nixon & Fulweiler 2009). Possibly the most adopted productivity scale for classification of marine ecosystems is the one proposed by Nixon (1995):

- Oligotrophic systems, with productivity rate  $<100 \text{ gC}\cdot\text{m}^{-2}\cdot\text{y}^{-1}$ ;
- Mesotrophic systems, with productivity rate ranging from  $100\text{-}300 \text{ gC}\cdot\text{m}^{-2}\cdot\text{y}^{-1}$ ;
- Eutrophic systems, with productivity rate ranging from  $301\text{-}500 \text{ gC}\cdot\text{m}^{-2}\cdot\text{y}^{-1}$ ;
- Hypertrophic, with productivity rate  $>500 \text{ gC}\cdot\text{m}^{-2}\cdot\text{y}^{-1}$ .

Alone, these values are not indicative of ecological degradation or problems associated with eutrophication. Highly productive systems (i.e. eutrophic) associated with upwelling conditions to feed and renew their biogeochemical processes may be far from cultural eutrophication (i.e. with anthropogenic causes), as can be found in the Patagonian shelf ( $>500 \text{ gC}\cdot\text{m}^{-2}\cdot\text{yr}^{-1}$ ), the Benguela Current off Southwest Africa ( $>500 \text{ gC}\cdot\text{m}^{-2}\cdot\text{yr}^{-1}$ ), the Canary Current off Northwest Africa ( $>400 \text{ gC}\cdot\text{m}^{-2}\cdot\text{yr}^{-1}$ ), and the Humboldt Current off Peru and Chile ( $>300 \text{ gC}\cdot\text{m}^{-2}\cdot\text{yr}^{-1}$ ) mainly powered by upwelling resurface of nutrients (and recycling) allied to longitudinal currents that prevent stratification.

### 3.1.4 Organic loading

With the increasing human pressure caused by excessive population growth on coastal areas (de Jonge et al. 2002) and the installation of urban water infrastructures and sewage systems, especially in Europe and North America, together with industrial wastewater (e.g. food



processing, paper, textiles), a significant load of organic matter is delivered to coastal waters (Nixon & Fulweiler 2009).

Historically, the first concern was directed to human health and aesthetics, and a reduction of its pathogenicity was achieved. The same did not happen to the organic matter input to coastal ecosystems, where bottom waters gradually became hypoxic and the ecological impacts soon turned visible (Nixon & Fulweiler 2009).

While starting up to tackle the problem in the 1960s and 1970s with secondary treatment aiming at reducing BOD of discharged wastewaters, several regions of the world (mainly developing countries) are still facing a similar impact (Nixon & Fulweiler 2009).

Moreover, when modelling the organic carbon loadings for places with significant sources of allochthonous carbon, like estuaries or highly populated coastal areas, the carbon input to bottom processes may be relevant, but the uncertainty associated with determining the labile fraction is very high (Nixon 1995).

### **3.1.5 Nutrients enrichment**

Nutrients enrichment of coastal ecosystems originated from freshwater runoff after the large-scale introduction of inorganic fertilizers and detergents worldwide (de Jonge et al. 2002) has been identified as the main cause for marine eutrophication (Nixon 1995; Smith et al. 1999). Apart from less significant causes the human mobilization of N and P to coastal waters has grown into a serious environmental concern because of its ability to stimulate primary production and disrupt the production/metabolism balance of organic matter in coastal areas (Cloern 2001).

The anthropogenic nutrient enrichment is recognized as highly widespread and more damaging than organic loading (Nixon & Fulweiler 2009), especially due to the nutrients recycling/regeneration in the recipient ecosystem. While organic matter is degraded once by heterotrophic bacteria (Levin et al. 2009) nutrients can be incorporated into biomass several times, increasing its retention time before eventually being flushed away from the regeneration cycle (or abstracted, e.g. biomass capture by fishing, or deep buried in sediments). Nutrients are turned available as organic matter is degraded (and oxygen is consumed) and by excretion products from heterotrophic grazers (Clark et al. 2008), and can be recycled into 'regenerated production' (Wassmann 1990; Domine et al. 2010).

### **3.1.6 Nitrogen cycle**

Studies have shown that N availability acts as a limiting and controlling factor of primary production in estuarine and marine waters (Vitousek et al. 2002; Howarth & Marino 2006). In principle, the concept of 'limiting nutrient' states that one nutrient is limiting the growth (size and number) of a resident population and that all other nutrients are available in excess. If an additional amount of the limiting nutrient is introduced into the system, this will promote an increase in growth. On the other hand, an introduction of any of the other nutrients will have no reflection on growth as they are already in excess (Finnveden & Potting 1999). Freshwater systems are often limited by phosphorous, marine systems by nitrogen, and estuarine systems by either or both. For modelling purposes the 'limiting nutrient' concept is a simplification, as exceptions can be found, other nutrients can be limiting in specific conditions, variations along the annual seasons, and different species can show different requirements (Finnveden & Potting 1999).

While this N limitation in ecosystems is a natural process, human interventions have greatly interfered with the N cycling in the various environmental compartments, from a local to a global scale (Howarth & Marino 2006). Anthropogenic sources of N to natural systems have increased greatly in the recent decades to accommodate the demand for food of a fast growing human population by means of production of reactive N for fertilizer use, and inadvertently, from combustion of fossil fuels (Galloway et al. 2004).

Food production activities have increased fixation of atmospheric N<sub>2</sub> (by legumes and rice cultivation) and intensive agricultural activities that lead to the industrial production of reactive N. Energy production emits NO<sub>x</sub> during combustion of fossil fuels, either by an oxidation process of atmospheric N<sub>2</sub> or fuel's organic N (mainly in coal and biomass burning) (Socolow 1999; Galloway et al. 2002). While intensive use of fertilizers in food production introduces new N into the environment, fossil fuels combustion simply mobilizes once sequestered N.

Vitousek et al. (1997) and Scavia et al. (2002) have recognized the anthropogenic introduction of N in the environment as "*one of the greatest consequences of human-accelerated global change on the coastal oceans of the world*" (Howarth & Marino 2006, p. 364)

Facing a patently growing (and unavoidable) demand for food and energy production to such an alarming magnitude, the sustainability of natural and man-made productive ecosystems raises critical concerns about the current and future fate and impacts of further introductions of N in the environment. The complexity of an accurate assessment of emissions, transport, transformation, and deposition processes of the various N forms makes monitoring, modelling, and damage estimation a challenging exercise. Life cycle thinking and methodologies can be applied here in the attempt to contribute to understand and estimate the importance of potential impacts of such emissions. Still, the broad reach of the N cycle in the geochemical fluxes of C and P, and on a variety of biological cycles, significantly impacts the human economy, society, and environment in regional to global changes, like carbon balance, acidification, terrestrial and marine eutrophication, that are currently being addressed by scientist, managers, and regulators.

### 3.1.7 Effects of nitrogen in marine waters

The biological response to nutrients loadings to the marine system is phytoplankton growth, shown either by increased individual biomass or population numbers. Ecologically, this means that photosynthesis in the photic zone by primary producers is enhanced by newly-available nutrients. In oligotrophic waters the enhanced growth of this primary production is mainly consumed by the secondary production (Powers et al. 2005) rendering little negative impacts off the nutrients enrichment. However, in eutrophic waters (already bearing high productivity) nutrients loadings may result in excessive phytoplankton biomass and significant ecological impacts.

High productivity in the photic zone may (i) change communities' composition and species interaction, enhancing the growth of toxic and harmful algal species, triggering harmful algal blooms (HAB) events, (ii) decrease water quality, by high turbidity, colour, and smell, hindering water uses, fish production, and aesthetic value, and (iii) deplete dissolved oxygen in bottom waters with resulting impact on the benthic species survival (Kelly 2008).

The effects addressed in this report refer to those related to the photosynthesis in the photic zone and those that potentially occur in bottom waters affecting benthic, demersal, or benthopelagic species, in coastal marine systems that are sufficiently eutrophic to be negatively affected by further anthropogenic nutrients enrichment. This excludes the impacts (either positive



or negative) in oligotrophic systems seasonally affected by natural upwelling-fed nutrients inputs for instance.

In this section, the focus is put on the fate of the excessive phytoplankton biomass as it is degraded in bottom waters resulting in dissolved oxygen depletion and hypoxia.

### **Hypoxia**

Hypoxia of marine coastal waters is a shortage of dissolved oxygen (DO) that can be caused by natural processes or by human interventions that promote an excessive consumption of oxygen, or by the interaction of both (Levin et al. 2009). The processes are basically the same and involve a biological demand of oxygen (i.e. BOD) greater than its supply, thus the depletion. In the case of marine eutrophication, the oxygen near the sediments is consumed as aerobic bacteria decompose the organic matter (the senescent biomass from above) (Levin et al. 2009; Middleburg & Levin 2009) potentially developing into hypoxic conditions.

As suggested by EC (2009) following OSPAR's (2008) proposal, hypoxia occurs as DO drops below 6 mg/L in bottom waters. Alternative classifications have been produced (*cf.* Riedel et al. 2008), with normoxia for  $DO > 2$  ml/L) but not adopted here.

In highly stratified waters the DO depletion under the pycnocline can bring the water masses to severe hypoxia and even anoxia closer to the bottom. Severe anoxia is conventionally defined as the threshold below which the impacts on biota are significant (Thibodeau et al. 2006) and DO drops below 2 mg/L (or 1.42 ml/L, 62.5  $\mu$ M, approximately 30% oxygen saturation), i.e. fisheries collapse (Diaz & Rosenberg 1995; Rabalais et al. 2001; Vaquer-Sunyer & Duarte 2008; Levin et al. 2009). Reviews of experimental data (Gray et al. 2002; Vaquer-Sunyer & Duarte 2008) point for an inadequacy of such threshold for the description of hypoxia stress triggering, as many species show significant responses and mortality at higher DO concentrations. Data show that responses significantly vary across taxa and that the conventional 2 mg/L of DO to define hypoxic waters falls "*below the empirical sublethal and lethal  $O_2$  thresholds for half of the species tested*" (Vaquer-Sunyer & Duarte 2008, p. 15452).

Coastal hypoxia is a major threat to shallow coastal ecosystems and shown to be responsible for mortality events resulting in wide depletion of metazoans in some ecosystems ('dead zones') (Rabalais et al. 2002; Diaz & Rosenberg 2008). Moreover, the proliferation of hypoxic zones along populated coastal areas and estuaries has been associated with nutrients loading from anthropogenic sources and coastal eutrophication (Turner & Rabalais 1994; Diaz & Rosenberg 1995; Cloern 2001; Gray et al. 2002; Thibodeau et al. 2006).

### **Impacts of hypoxia on biota**

The impacts of hypoxia on biota depend much on the severity (intensity), frequency and duration of the exposure to reduced DO in marine ecosystems (Powers et al. 2005; Haselmair et al. 2010). Both acute and chronic effects can be mentioned, including behaviour and physiological adaptations (Diaz & Rosenberg 1995; Burnett & Stickle 2001; Gray et al. 2002; Wu 2002).

In general, crustaceans show the highest sensitivity to lower oxygen saturation rates (with high  $LC_{50}$  results and low  $LT_{50}$ ) followed by fishes (with high  $SLC_{50}$  results). Larval stages are also referred as more sensitive than adults (Miller et al. 2002). On their turn, molluscs (with the lowest  $LC_{50}$ ), cnidarians (with the lowest  $SLC_{50}$ ) and priapulids (with the highest  $LT_{50}$ ) show more tolerance to oxygen depletion.

Mortality is observed for the majority of benthic organisms at  $DO < 3$  mg/L, which corresponds to the 83<sup>rd</sup> percentile of the distribution of their  $LC_{50}$  values (Vaquer-Sunyer & Duarte 2008). Exposure to extreme or prolonged hypoxia leads to mass mortalities, however hypoxia induces many different sub-lethal responses on organisms at the:

- Behavioural level – triggering behavioural changes (Riedel et al. 2008) and avoidance strategies (Vaquer-Sunyer & Duarte 2008);
- Physiological level – reduced tolerance to other stressors, limiting energy budget, growth rate, activity and respiration rate (Burnett & Stickle 2001);
- Ecological level - altering structure, function, and services of benthic communities (Levin et al. 2009; Sala & Knowlton 2006).

On the ecological level, Levin et al. (2009) present a comprehensive review of the effects of both natural and human-induced hypoxia on coastal benthos species over several regional studies. In general, the ecological impact on benthic communities related to hypoxia leads to the loss of the buffer species that contribute to resilience. Moreover, benthic communities normally increase oxygen penetration into the soft bottom sediments through bioirrigation and bioturbation (Steckbauer et al. 2011) and their loss may lead to changes in the sediment chemistry, mainly shifting to anaerobic metabolic pathways (mostly sulphate reduction) intensifying the biological impacts (Vaquer-Sunyer & Duarte 2010), imposing a positive feedback on oxygen depletion (trapping oxygen) (Steckbauer et al. 2011), releasing stocked nutrients (Conley et al. 2009), and impacting elemental cycling (Middleburg & Levin 2009).

### 3.1.8 Data search

Specific information about species sensitivity, distribution, ecology, and LME was mainly found by searching the following data sources:

- Vaquer-Sunyer & Duarte (2008) – Review of species sensitivity data to hypoxia, including laboratory  $SLC_{50}$  values for 65 species;
- The World Register of Marine Species (WoRMS) ([marinespecies.org](http://marinespecies.org)) – A taxonomic database for marine species with ecological and distribution information (Appeltans et al. 2012);
- The Species 2000 & ITIS Catalogue of Life ([www.catalogueoflife.org](http://www.catalogueoflife.org)) – A comprehensive catalogue of known species and compilation from 66 other source databases with useful taxonomic and distribution information (Bisby et al. 2009);
- Fishbase ([www.fishbase.org](http://www.fishbase.org)) – Database on fish species with taxonomic, distribution and ecology information (Froese & Pauly 2012);
- Large Marine Ecosystems of the World (<http://www.lme.noaa.gov/>) – The compiled information and reports on the LMEs and the LME biogeographical classification system;
- Sea Around Us Project (<http://www.searoundus.org/lme/>) – Database for Fisheries, Ecosystems and Biodiversity of the LME biogeographical classification system.

All the remaining information and data used in the present study was found in the sources cited in the text and later listed under the Section *References*.

### 3.1.9 Research goals

The eutrophication impacts of anthropogenic N inputs to marine ecosystems depend on the fate processes and the sensitivity of receiving environments. Spatial differentiation is also important to discriminate the distribution of impact estimation results, to improve the fate model accuracy and the overall model applicability. A suitable impact assessment methodology for global marine eutrophication at endpoint is still lacking in LCIA. While the fate modelling has been the subject of advances and contributions, it has not yet been feasible to fully relate nitrogen concentrations in marine coastal waters to the effects on resident species of these ecosystems, meaning that the estimation of an ecological damage factor for nitrogen enrichment of marine coastal waters in terms of loss of biodiversity would be scientifically relevant.

Facing these needs and the available information, the present study aims at (i) understanding the fate processes affecting nitrogen loading to coastal waters, (ii) defining and estimating factors for the impact characterisation (CFs), (iii) introducing spatial differentiation at a suitable scale, in order to (iv) build a marine eutrophication damage model for application as a LCIA methodology.

## 3.2 Methodology

### 3.2.1 Framework

The system boundaries defined for the present study were set to solely include the processes regarding marine eutrophication. The inputs to this system are derived from the global processes involving atmospheric nitrogen and freshwater/terrestrial fate of N from inorganic fertilizers used in agriculture, manure used in agriculture, N-fixation in agriculture, air emissions as NH<sub>3</sub>, air emissions as NO<sub>x</sub>, and sewage discharges.

The relevant processes in the cause-effect chain for marine eutrophication are presented in Figure 3.1, which also identifies the processes that are included in the modelling of fate, exposure, and effect factors.

The estimation of potential impacts for marine eutrophication is built on the application of Characterisation Factors (CF, unit: (PAF·)[m<sup>3</sup>·d/kgN]), defined by:

$$CF_{ij} = FF_{ij} \times XF_j \times EF_j$$

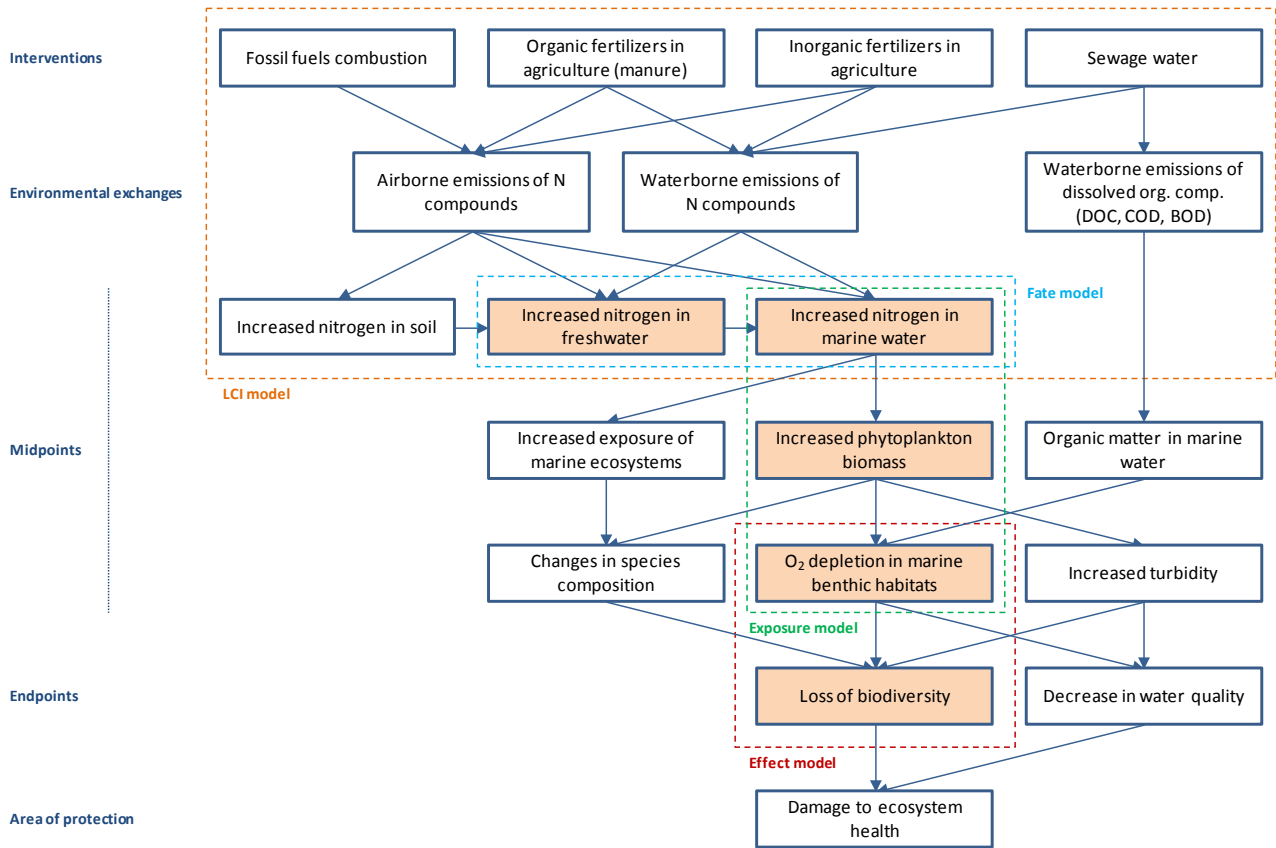
Where FF is the Fate Factor (unit: [d]) for emission route *i* to receiving ecosystem *j*, XF is the Exposure Factor (unit: [kgO<sub>2</sub>/kgN]) in receiving ecosystem *j*, and EF is the Effect Factor (unit: (PAF·)[m<sup>3</sup>/kgO<sub>2</sub>]) in receiving ecosystem *j*.

Emission routes include “N to air”, “N to surface freshwater”, “N to groundwater” and “N to coastal marine waters”. The receiving ecosystems considered in the present study are the Large Marine Ecosystems (LME) spatial units (see 3.2.2).

The FF estimates the N fraction exported to marine waters and the N losses in the marine compartment, thus expressing how N loadings into this compartment vary. The FF depends on the N fate in soil, the atmospheric fate, the fate in freshwater systems, and on the losses once in the marine compartment (denitrification, advection and sedimentation).

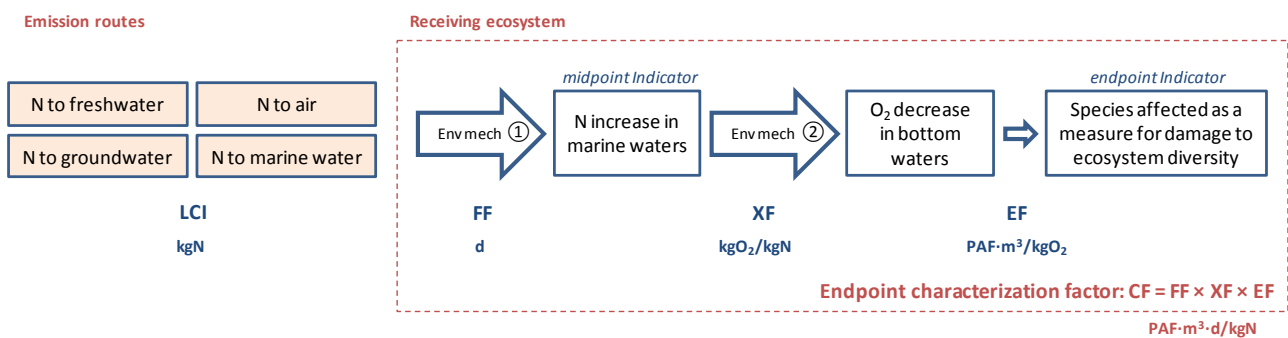
The XF expresses the conversion from nitrogen to organic matter (phytoplankton biomass) in the photic zone and to dissolved oxygen consumption in bottom waters.

The EF represents the change in the potentially affected fraction of species (PAF) in the receiving marine ecosystem due to the change in dissolved oxygen.



**Figure 3.1:** Cause-effect chain for marine eutrophication from sources of N emissions, midpoint, and endpoint processes, also showing those included in the fate, exposure and effect models (orange-shaded boxes).

The marine eutrophication model (Figure 3.2) may be seen as a combination of an environmental mechanism governing the fate of nitrogen and another environmental mechanism governing the oxygen depletion that results in impact on biota.



**Figure 3.2:** Harmonized midpoint-endpoint model for marine eutrophication linking human interventions to ecosystem damage.

The diagram above is the basis for the LCIA calculations and estimation of CF and ultimately builds up on the cause-effect chain (Figure 3.1).

As seen above, the proposed model deals with the fate and effect components of nitrogen involved in the marine eutrophication processes at both midpoint and endpoint levels. Additions of N to the marine system results in enhanced phytoplankton biomass that eventually sink and decay by the action of bacterial degradation consuming dissolved oxygen; the benthic habitat is affected by the low dissolved oxygen levels and biota is affected at different scales depending on their specific sensitivity to hypoxia.

These fate and effect processes try to explain the marine eutrophication phenomenon and are the basis to the present damage model. Further details are described later in this chapter.

### 3.2.2 Unit areas for spatial differentiation

#### *The biogeographical classification system*

The delimitation of the applicable study areas, with special relevance for the spatially differentiated modelling, is drawn from a biogeographical classification system proposed by the U.S. National Oceanic and Atmospheric Administration (NOAA) identifying 64 Large Marine Ecosystems (LME), set for areas of the oceans defined for conservation purposes (Sherman 1991).

Spalding et al. (2007) and UNESCO (2009) reviewed some of these biogeographic classification systems.

Overall, the availability and dispersion of data sources, geographic coverage and representativeness, ecological relevance, and adaptation to the needs of the present study, were the criteria for selecting the most suitable option. The LME classification system was adopted here as better suiting the study purpose as they refer to the marine area from the coastal areas (neritic zone) plus river basins and estuaries to the seaward boundaries of the continental shelf with a particular influence of mixing processes that promote a good oxygenation and stable temperature and salinity. Additionally, the presence of light (fundamental in the continental shelf) and nutrients (from freshwater and terrestrial run-off) promotes the occurrence of phytoplanktonic species. Overall, LMEs are characterized by its *“distinct bathymetry, hydrography, productivity and trophically dependent populations”* (Sherman & Duda 1999, p. 15). LMEs are mainly aiming at providing a basis for practical application of transboundary management issues in 5 modules (productivity and oceanography, fish and fisheries, pollution and ecosystem health, socioeconomics, and governance (Spalding et al. 2007). The 64 LMEs were developed and presented as ecologically rational units of ocean space in which ecosystem-based management can be applied (Mahon et al. 2010), and it is this integrated approach that builds the criteria for choosing LMEs as suitable study areas for marine eutrophication.

The identification of the 64 LMEs and their geographical location can be found in Figure 3.6 (Appendix 3-I).

Spalding et al. (2007) point to some criticisms to the LME classification system, including the fact that it is an *“expert-derived system without a rigorous, replicable core definition”* and that it is focused on *“productivity and oceanographic processes, and in its present form omits substantial areas of islands in the Pacific and the Indian oceans”* (Spalding et al. 2007, p. 574). However, considering the suitability of the LME classification system to represent the receiving compartment of terrestrial/freshwater N, the amount of data available for productivity, and ease

of adaptation to a climate zonation, overcomes the referred weaknesses. No classification system is perfect, but using the LME system seems like an opportunity rather than a challenge.

A necessary assumption here is that the sea bottom area is set to correspond to the sea surface area, disregarding slope profile and roughness of the bottom, thus underestimating the bottom area. Nevertheless, it seems a good proxy considering the purposes of the study, the effort needed to calculate the bottom area, and the resulting associated uncertainty.

### ***Grouping spatial units into climate zones***

Spatial units (LMEs) were grouped in climate zones (Tropical, Subtropical, Temperate, Subpolar, and Polar) to provide regional assessment of impacts on biota. The basis for the grouping was mainly geographic coverage and water temperature, as explained next:

- Latitudinal distribution: Tropical from Equator to  $\approx 20^{\circ}\text{N}$ , Subtropical from  $\approx 20^{\circ}\text{--}30^{\circ}\text{N}$ , Temperate from  $\approx 30^{\circ}\text{--}50^{\circ}\text{N}$ , Subpolar from  $\approx 50^{\circ}\text{--}70^{\circ}\text{N}$ , and Polar from  $\approx 70^{\circ}\text{--}90^{\circ}\text{N}$  (and the same for the Southern Hemisphere);
- Mean annual sea surface temperature (maSST): based on the information included in the LME briefs (data collection of specific distinctive characteristics) provided by NOAA (2012) where maSST is presented as a dataset extending from 1975-2005 and a regression curve fitted to assess variation trends in each LME. Individual regression equations were used to estimate maSST for 2012 for each LME, which were the used to complement the grouping of LMEs into the 5 climate zones (Table 3.5 in Appendix 3-II);
- To help on the classification of certain LMEs, complementary information was found on the Marine Ecoregions of the World (MEOW) classification system (Spalding et al. 2007) and on the Köppen-Geiger climate classification system (Peel et al. 2007).

### **3.2.3 Fate Factors (FF) and the fate model**

The  $FF_{i,j}$  (unit: [d]) is obtained by:

$$FF_{i,j} = \frac{f_{\text{exp } i}}{\lambda_j}$$

Where:

$f_{\text{exp } i}$  (fraction, [-]) is the fraction of N exported to coastal marine waters calculated for each emission route  $i$ , and

$\lambda_j$  (unit: [ $\text{d}^{-1}$ ]) is the N loss rate coefficient in receiving ecosystem  $j$

The receiving ecosystems considered in this study are the Large Marine Ecosystems (LME) defined by NOAA (Sherman 1991).

The FFs were estimated at a country-to-LME level per emission route, i.e. factors for an emitting country to a receiving LME, e.g. “Canada to LME#2. Gulf of Alaska” and “Canada to LME#63. Hudson Bay” (x4 emission routes: “N to air”, “N to surface freshwater”, “N to groundwater” and “N to marine coastal water”).

The fate model is composed of a land based component and a marine based component. The first deals with the loss/transformations processes affecting N forms from air emissions and its deposition, agricultural and natural land, groundwater, and surface freshwater systems. The



marine component deals with N losses due to denitrification, advection, and sedimentation in marine coastal waters.

### ***Estimation of N export to coastal marine waters ( $f_{exp}$ )***

Atmospheric emissions of either NO<sub>x</sub> or NH<sub>3</sub> will deposit differently in natural soil, agricultural soil, surface freshwater, and sea (oceanic and coastal) waters. Roy (2012) has provided a model dataset that delivers the amounts of these N forms being deposited in various countries from any emitting country (data available for 236 countries).

The model estimates the N amount deposited in marine waters and land. The fraction deposited on marine waters can be further differentiated in 0.9 to coastal marine waters (mw) and 0.1 to oceanic waters (Roy et al. 2012). The fraction deposited inland is then further divided into 0.604 to natural soil (ns) and 0.362 to agricultural soil (as) (Bouwman et al 2011a), and 0.034 to surface freshwater (sfw) (Larsen et al 2009).

Leaching to sfw is estimated at 0.142 (from ns) and 0.081 (from as) after accounting for harvesting/grazing, topsoil denitrification, and infiltration to groundwater (gw), which also applies to the N forms amount emitted from agricultural systems.

Denitrification losses in gw is estimated at 0.646 (Bouwman 2011b) and at 0.527 (Wollheim et al. 2008) in sfw.

The estimation of the exported amount of N to marine coastal waters for each of the emission routes, which are identified as “N to air”, “N to sfw”, “N to gw”, and “N to mw”, is obtained by applying the mentioned fractions (see also Table 3.1 below).

**Table 3.1:** N fractions applicable in the calculation of N export to coastal marine waters.

<b>Fraction</b>	<b>Value</b>	<b>Source</b>
<b>Deposition (1.000)</b>		
$f_{dep}$ to sea	× country $f$	Roy (2012)
$f_{dep}$ to mw	× 0.900	Roy et al. (2012)
$f_{dep}$ to inland	× (1-country $f$ )	Roy (2012)
<b>Deposition inland</b>		
$f_{dep}$ to ns	× 0.604	Bouwman et al. (2011a)
$f_{dep}$ to as	× 0.362	Bouwman et al. (2011a)
$f_{dep}$ to sfw	× 0.034	Larsen et al. (2009)
<b>Leaching to sfw</b>		
$f_{leach}$ from ns	× 0.142	Bouwman et al. (2011b)
$f_{leach}$ from as	× 0.081	Bouwman et al. (2011b)
<b>Denitrification</b>		
Denitr in gw	× 0.354	Bouwman et al. (2011b)
Denitr in sfw	× 0.473	Wollheim et al. (2008)

The calculations lead to an exported fraction of N to mw originated from the N emission to air obtained by:

$$\begin{aligned}
 & (LCI N_{to\ air}) * f_{dep\ to\ sea} * f_{dep\ to\ mw} + \\
 & (LCI N_{to\ air}) * f\ to\ inland * f_{dep\ to\ ns} * f_{leach\ from\ ns} * Denitr\ in\ sfw + \\
 & (LCI N_{to\ air}) * f\ to\ inland * f_{dep\ to\ as} * f_{leach\ from\ as} * Denitr\ in\ sfw + \\
 & (LCI N_{to\ air}) * f\ to\ inland * f_{dep\ to\ sfs} * Denitr\ in\ sfw
 \end{aligned}$$

The exported fraction of N to mw originated from the N emission to sfw is obtained by:  
 $(LCI N_{to\ sfw}) * Denitr\ in\ sfw$

The exported fraction of N to mw originated from the N emission to gw is obtained by:  
 $(LCI N_{to\ gw}) * Denitr\ in\ gw * Denitr\ in\ sfw$

The exported fraction of N to mw originated from direct N emission to mw is obtained by:  
 $(LCI N_{to\ mw}) * 1$

Overall, the exported amount of N involves the application of a loss fraction, or exported fraction ( $f_{exp}$ ), to the N amount emitted and identified with the help of an LCI model.

A suitable LCI model should be applied to estimate relevant outputs from human interventions, such as fertilizer application in agriculture, air emissions, treated sewage discharges. Examples of such LCI models can be found in Van Drecht et al. (2003) and Bouwman et al. (2009) – agriculture exports, Van Drecht et al. (2009) – sewage emissions, Roy et al. (2012) – atmospheric emissions and deposition, Wollheim et al. (2006, 2008) – N losses in freshwater systems.

#### ***Data sources for N-emissions and N-export calculations***

Nitrogen emissions per country were provided by Bouwman and co-workers (Bouwman 2011a).

Export rates of N from non-point sources to rivers (leaching and denitrification rates) were provided by Bouwman and co-workers (Bouwman 2011b) as the result of the modelling work described by Van Drecht et al. (2003) and Bouwman et al. (2009).

Atmospheric nitrogen emissions and deposition rates at country level were provided by Roy and co-workers (Roy 2012) following the model by Roy et al. (2012).

Nitrogen losses in river systems were obtained from the removal model implemented with FrAMES-N by Wollheim et al. (2006, 2008).

#### ***Estimation of the nitrogen loss rate coefficient ( $\lambda$ ) in the marine compartment***

Nitrogen losses in marine coastal waters can be caused by:

- Denitrification, which is the reduction of oxidized forms of nitrogen ( $NO_3^-$ ,  $NO_2^-$  and NO) into  $N_2$  in a microbial-mediated process in the bottom sediments;
- Advection, which represents the transport of nitrogen forms from the considered spatial unit by the effect of local hydrodynamics (equivalent to flushing);
- Sedimentation, which represents a loss to mineralization of nitrogen forms into bottom sediments.

The nitrogen losses estimation applies the same denitrification rates as for rivers (30%) calculated by Van Drecht et al. (2003) and sedimentation rates (5%) in literature (Nixon et al. 1996). The hydraulic residence times for some of the receiving LME were found in literature (listed in Table 3.6 in Appendix 3-III), while four archetypes were applied to the LME for which no data was found or to settle high variability data, based on coastal exposure to currents and regional ocean circulation, depth, and coastal profile, as follows:



- High dynamics and exposure to regional currents: residence time estimated of 3 months (archetype 1);
- Medium dynamics and exposure to local currents: estimated residence time of 2 years (archetype 2);
- Low dynamics: estimated residence time of 25 years (archetype 3);
- Very low dynamics or embayment: estimated residence time of 90 years (archetype 4).

The N-loss routes 'denitrification' ( $\lambda_{denitr}$ ) and 'sedimentation' ( $\lambda_{sed}$ ) are obtained from the equation for the expected first-order kinetics with a constant removal rate ( $\lambda$ ):

$$N_t = N_0 \cdot e^{-\lambda_r t}$$

Where  $N_0$  is initial nitrogen amount [kgN],  $N_t$  is the nitrogen amount [kgN] after time  $t$  [yr], and  $\lambda_r$  is the removal rate [ $\text{yr}^{-1}$ ] per loss route  $r$  (*denitr*, *sed*).

The loss route 'advection' ( $\lambda_{adv}$ ) can be estimated using the LME residence time ( $\lambda_{adv j} = 1/\tau_{LME j}$ ).

The overall N loss rate for receiving ecosystem ( $j$ ) is then calculated by:

$$\lambda_{LME j} = \lambda_{denitr j} + \frac{1}{\tau_{LME j}} + \lambda_{sed j}$$

The calculations, data, and results of the N loss rate coefficients estimations for the various LMEs can be found in Table 3.7 in Appendix 3-III.

### 3.2.4 Exposure Factors (XF)

The  $XF_j$  [unit:  $\text{kgO}_2/\text{kgN}$ ] for any receiving ecosystem  $j$  is obtained by:

$$XF_j = \frac{\text{kgOM}}{\text{kgN}} \times \frac{\text{kgO}_2 \times (1 - BGE)}{\text{kgOM}} \times NIE_j \times VCC$$

The nitrogen in the photic zone is incorporated into phytoplankton biomass (OM:N ratio) which induces a consumption of dissolved oxygen in the benthic habitat ( $\text{O}_2$ :OM ratio) with its degradation. This N: $\text{O}_2$  conversion is affected by a bacterial growth efficiency (BGE) coefficient.

The XF expresses the potential exposure of the target species to the available N (resulting from the fate estimations), relating nitrogen in the photic zone to dissolved oxygen (DO) consumption in bottom waters (benthic habitat). It further applies a site-dependent Nitrogen Incorporation Efficiency (NIE) concept, which depends on the response of individual receiving LME  $j$ , i.e the differentiated productivity rates in response to the combined effect of the different local environmental factors. A volume conversion coefficient (VCC) was included to account for the different volumes of the photic zone and the benthic habitat at the bottom

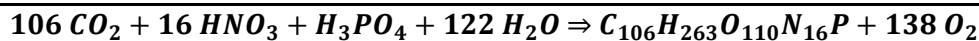
#### **The OM:N ratio**

The correlation between N incorporation and DO consumption in bottom waters is obtained from the stoichiometry of both photosynthesis and organic matter (OM) degradation (bacterial respiration) governing reactions. It is assumed that OM degradation is the only DO-loss process in the bottom layer.

The estimation of the production of phytoplankton biomass is obtained from photosynthesis, where inorganic nutrients, carbon dioxide, and water are converted into organic matter and oxygen.

The elemental composition of marine phytoplankton biomass was found similar to the major dissolved inorganic nutrients in the deep ocean by Alfred Redfield (Redfield 1934) supporting the concept of reciprocity between organisms and environment (Redfield 1958). The initially proposed molar ratio for nitrate:phosphate (N:P) of 16:1 was supported by remineralization of phytoplankton with release of N and P to the environment at this specific ratio. Later, this ratio was extended to include carbon (C) on a C:N:P ratio of 106:16:1 (Arrigo 2005) as shown in the OM term. The Redfield ratio is still adopted in modelling studies and it is often assumed that the average phytoplankton stoichiometry is consistent with it, despite the oversimplification involved and the many studies challenging the ratio in different locations, species, or life stages (Arrigo 2005).

The OM:N ratio assumes the Redfield ratio to define the average stoichiometry of the production of biomass of marine primary producers (Sand-Jensen 2000) from a certain amount of input of N.



Using molar masses ( $M$ ):

$$\text{Biomass: } \text{C}_{106}\text{H}_{263}\text{O}_{110}\text{N}_{16}\text{P} = 12.0107_{106} + 1.00794_{263} + 15.9994_{110} + 14.0067_{16} + 30.973762 = 3553.2$$

$$N_{\text{input}} : 16\text{N} = 16 * 14.00674 = 224.1$$

$$\text{Conversion rate} = \frac{M(\text{Biomass})}{M(N_{\text{input}})} \approx \frac{3553}{224} \approx 15.86 \text{ gOM/gN}$$

#### Application

The hypothetical input of 1 kg of N:

$$\text{Biomass} = \text{mass } N_{\text{input}} \times \text{conv rate} = 10^3 \text{ gN} \times 15.86 \text{ gOM/gN} = 1.59 \cdot 10^4 \text{ gOM}$$

results in an hypothetical production of 15.9 kg of phytoplankton biomass.

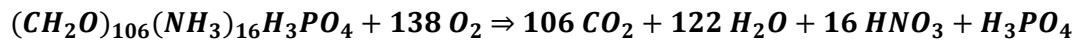
---

### **The O<sub>2</sub>:OM ratio**

The phytoplankton biomass produced in the photic zone goes through a senescence phase. This decay results in the sinking of degradable organic matter to bottom waters where degradation by heterotrophic bacteria (respiration) takes place. In this process, oxygen is consumed, and carbon dioxide, nitrate, and phosphate are released to the water mass, explaining both the depletion of DO in bottom waters and the potential 'recycling' of nutrients after remineralization. Some of the nutrients end in a refractory fraction that becomes part of the sediment (Gulliver et al. 2010).

Based on the stoichiometry of the OM degradation equation and on the specific molar mass ( $M$ ) of the reaction's components the ratio between the amount of degradable OM and the oxygen required for its degradation is  $\approx 1:1.24$  (OM:O<sub>2</sub>) (cf. calculations shown next).

Degradation of organic matter (heterotrophic bacteria respiration):



Organic matter shown as:  $(CH_2O)_{106}(NH_3)_{16}H_3PO_4$  i.e.  $M = 3553.2 \text{ gOM} \cdot \text{mol}^{-1}$

Oxygen consumed:  $138 O_2$  i.e.  $M = 4415.8 \text{ gO} \cdot \text{mol}^{-1}$

$$O_2:OM \text{ ratio: } \frac{O_2}{OM} \approx \frac{4416}{3553} \approx 1.24 \text{ gO}_2/\text{gOM}$$

#### Application

Following the hypothetical input of N from before, using 15.9 kg of OM:

$$\begin{aligned} \text{total } O_2 \text{ consumed} &= \text{mass of OM} \times O_2:OM \text{ ratio} \\ &= 1.59 \cdot 10^4 \text{ gOM} \times 1.24 \text{ gO}_2/\text{gOM} = 1.97 \cdot 10^4 \text{ gO}_2 \end{aligned}$$

results in the consumption of 19.7 kgO<sub>2</sub> assuming 100% of OM respired

### **Bacterial Growth Efficiency (BGE)**

An additional coefficient (1-BGE) is added here to express the fraction of organic matter that is not respired. Some of the OM (26%) is incorporated into bacterial biomass and later mineralized into bottom sediments thus not contributing to DO consumption (del Giorgio & Cole 1998).

Following the hypothetical input of N from before, using 15.9 kg of OM:

$$\begin{aligned} \text{total } O_2 \text{ consumed} &= \text{mass of OM} \times O_2:OM \text{ ratio} \times (1 - BGE) \\ &= 1.59 \cdot 10^4 \text{ gOM} \times 1.24 \text{ gO}_2/\text{gOM} \times 0.74 = 1.46 \cdot 10^4 \text{ gO}_2 \end{aligned}$$

then actually resulting in the consumption of 14.6 kgO<sub>2</sub>

### **Estimating the Nitrogen Incorporation Efficiency (NIE) per LME**

As the modelling of the input/output balance is recognized as highly complex, a proxy for the net N-balance was here defined and found useful. This approach deals with the concept of Nitrogen Incorporation Efficiency (NIE) as a response of individual receiving water masses (LMEs in the present case) to the N loadings and N availability to primary production.

The productivity (primary production) rate is determined by the combined influence of many environmental factors, including light availability to power photosynthesis, water temperature, currents and advection regulating horizontal and vertical mixing of gases, nutrients, salinity, etc. The interaction of these factors is the subject of some dedicated models (like DHI's MIKE model and others) in the attempt to explain and describe the global outcome of the biogeochemical processes involved. Ultimately, these models can estimate biological parameters, such as productivity rates, with the necessary data input requirements, generally highly demanding. The NIE concept shows up as a possible tool to understand and roughly compare the responses of different LME exposed to different environmental conditions (light, temperature, mixing, nutrients, etc.) to the available nitrogen. The NIE involves the use of site-specific productivity rates that lead to the calculation of an expected amount of nitrogen incorporated obtained from an empirical PP-N relationship by Nixon *et al.* (1996), compared to the theoretical (stoichiometry-based) nitrogen needed in the system to generate the measured biomass and works as a proxy for the potential regeneration of N (i.e. reuse in further incorporation-mineralization cycles). In other

words, the ratio between how much N is actually incorporated in each considered ecosystem (or spatial unit) and how much N had to be available.

With NIE's application, LMEs showing environmental conditions favouring primary production will present higher nitrogen utilization possibly due to higher onwelling N supply. Less favourable conditions will lead to lower nitrogen use efficiency meaning that the environmental conditions are either limiting the biological processes, leading to more nitrogen losses (transformation or export), or the LME gets less onwelling N supply.

As the objective is not to determine exact figures for the N inputs and outputs but rather to compare different study areas by estimating NIE values of the various LME, the concept provides comparative information about the fate of N in marine waters. Additionally, it expresses the ecosystems' relative response and does not bring further complexity and uncertainty that modelling individual environmental factors (or combination of factors) would have. NIE calculations are explained below:

---

Starting from the PP rate available from the LME briefs by NOAA and using Nixon's equation (Nixon, 1996) relating PP and  $N_{input}$  ( $\log PP = 0.442 \times \log DIN + 2.332$ ) and Seitzinger's estimation (Seitzinger, 2010) of 40% of DIN in Total-N ( $DIN = 0.4 \times N_{tot}$ ), the Empirical  $N_{input}$  calculates as:

$$EmpN_{input} = \frac{DIN}{DIN \text{ content in } N_{tot}} \times M_N \times A_{LME}$$

Where  $DIN = 10^{(\log PP - 2.332)/0.442}$  in  $[\text{molN} \cdot \text{m}^{-2} \cdot \text{yr}^{-1}]$ , PP is the productivity rate of the study area  $[\text{gC} \cdot \text{m}^{-2} \cdot \text{yr}^{-1}]$ ,  $M_N$  the molar mass of nitrogen  $[\text{gN/mol}]$  and  $A_{LME}$  the area of the study area (or Large Marine Ecosystem)  $[\text{m}^2]$ .  $EmpN_{input} [\text{gN} \cdot \text{yr}^{-1}]$  expresses the N loading to marine coastal waters based on Nixon's empirical equation to support the given PP rate.

The theoretical  $N_{input}$  is estimated from the maximum conversion of N into biomass based on the stoichiometry of the photosynthesis equation and the Redfield ratio.

$$TheorN_{input} = PP \times \frac{M_N}{M_C} \times A_{LME}$$

Where PP is the productivity rate of the study area  $[\text{gC} \cdot \text{m}^{-2} \cdot \text{yr}^{-1}]$ ,  $M_N$  and  $M_C$  are molar masses of N and C respectively  $[\text{gC} \cdot \text{mol}^{-1}/\text{gN} \cdot \text{mol}^{-1}]$ , and  $A_{LME}$  the area of the study area (or Large Marine Ecosystem)  $[\text{m}^2]$ .  $TheorN_{input} [\text{gN} \cdot \text{yr}^{-1}]$  expresses the stoichiometric incorporation of N into biomass.

By comparing the empirical and the theoretical  $N_{input}$  it is possible to assess the net balance of losses and input rates within the specific ecosystem boundaries (study area or LME) as:

$$NIE = \frac{EmpN_{input}}{TheorN_{input}}$$


---

The NIE concept reads as: A certain incorporation rate of carbon through photosynthetic primary production into phytoplankton biomass (productivity rate) is the result of an addition of an average amount of nitrogen ( $EmpN_{input}$ ) estimated by an empirical relationship from various marine ecosystems. Although every study area uses nitrogen with different conversion efficiencies, a theoretical amount of nitrogen ( $TheorN_{input}$ ) is expected to feed that productivity rate, based on the stoichiometry of the photosynthetic governing equation.

Primary production rates per LME were obtained from NOAA and the 'Sea Around Us Project'. The NIE results per LME are shown in Table 3.8 in Appendix 3-IV.

### ***The volume correction coefficient (VCC)***

The photic zone is defined as the top layer of the water column exposed to sufficient solar radiation to support photosynthesis, downward to a depth where only 1% of the light intensity penetrates. The photic zone may extend down to ca. 200 m (open ocean) (NOAA, 2011) but varies with the light penetration (function of turbidity). As the spatial units considered in the present study are coastal zones, generally the neritic zone over the continental platform, the photic depth is highly reduced (assumed to half). As 100 m is deeper than the average photic zone depth of various of the considered LME and assuming that more than half of the LME area is on shallow waters (due to depth profile of the littoral zonation of the platform) an average photic zone of 30 m deep (for any LME) is assumed.

The thickness of the bottom layer is defined as 0.3 m assumed as providing a suitable benthic habitat layer to accommodate living species, either submerged aquatic vegetation (SAV), sessile animal species, bottom dependent animal species and free-swimming species that feed, reproduce, hide, or somehow spend there a part of their life cycle or habits.

The volume correction coefficient is then defined by:  $VCC = \frac{V_{benthic\ habitat}}{V_{photic\ zone}}$

### **3.2.5 Effect Factors (EF)**

The correlation between the dissolved oxygen depletion in the benthic habitat and the potential effect on biota is based on an extrapolation model of the sensitivity of single species to dissolved oxygen concentrations in the water, in accordance to what is defined by Posthuma et al. (2002).

The Species Sensitivity Distribution (SSD) methodology is a probabilistic model that estimates the variability of the sensitivity of biological species to a specific environmental stressor by means of a statistical or empirical distribution function of responses of a sampled group (Posthuma et al. 2002). Moreover, the distribution function is solely based on single species sensitivity (usually obtained by laboratorial experiments) and does not reflect ecosystem-level responses or ecological interactions (Blanck 1984).

In the present report, it is assumed that the dissolved oxygen depletion in the water mass triggers the stress effect and the sensitivity of biological species to it is used to estimate an effect on general populations. The practical results of such an analysis are either the estimation of a target concentration of dissolved oxygen in a perspective of protection of the occurring species, or the assessment of the risk associated with low dissolved oxygen concentrations.

The SSD concept usually assumes a parametric distribution (such as log-logistic) of the individual species sensitivity to hypoxia, from where the SSD parameters are estimated and ultimately the stressor concentration that is expected to result in a certain amount of effect. The same rationale is shared by Ecological Risk Assessment (ERA) predicting an effect from a known intensity of the stressor (like the estimation of PAF), or in establishing Environmental Quality Criteria (EQC) where a 'safe' concentration is defined bearing a known expected (and acceptable) effect (Posthuma et al. 2002).

The SSD-based methodology is commonly applied in ecotoxicology and species sensitivity to contaminants. In the present case, the effect posed by hypoxia (resulting from dissolved oxygen depletion in the water mass composing the marine benthic habitat) is understood as a stress agent similar to the physical and chemical effects of a 'traditional' contaminant. The basis for SSD is the

assumption that different species show different sensitivities to hypoxia and its application requires log-normality of the distribution of the sample's sensitivity data in order to assure representativeness of the natural target community (Posthuma et al. 2002). Statistical goodness-of-fit tests should be applied to the data before using and discussing SSD results. The goodness-of-fit test for log-normality of data distribution is included in Appendix 3-V.

The 'Species Sensitivity Distribution Generator' developed by The Causal Analysis/Diagnosis Decision Information System (CADDIS) of the U.S. Environmental Protection Agency (cf. USEPA 2004) was used for the calculation of SSD curves. The methodology and calculations follow those proposed by Posthuma et al. (2002). Details on the method can be found in Appendix 3-VI.

The SSD calculations are used to plot sensitivity data on a cause-effect perspective, i.e. stressor intensity (decreasing dissolved oxygen concentrations in the present case) is plotted as species'  $EC_{50}$  to a Potentially Affected Fraction (PAF) of species. From the resulting plots and curves fitting, the  $HC50_{EC50}$  and the Effect Factor (EF) are obtained.

The species sensitivity dataset was obtained from a comprehensive review by Vaquer-Sunyer & Duarte (2008) including sublethal concentrations ( $SLC_{50}$ ) of low dissolved oxygen concentrations (i.e. response to hypoxia) for 65 different species of the following taxa:

- Fish species (15): 12 Osteichthyes (bony fishes, *Superclass*) and 3 Chondrichthyes (cartilaginous fishes, *Class*);
- Echinoderms (7): 4 Ophiuroidea (brittle stars, *Class*), 1 Asteroidea (starfishes, *Class*), 1 Echinoidea (sea urchins, *Class*) and 1 Holothuroidea (sea cucumbers, *Class*);
- Crustaceans (13): 10 Decapoda (crabs, lobsters, prawns, shrimps, *Order*), 1 Isopoda (pillbugs, woodlice, *Order*), 1 Amphipoda (amphipods, *Order*), and 1 Stomatopoda (mantis shrimps, *Order*);
- Molluscs (7): 5 Bivalvia (bivalves, *Class*), 1 Gastropoda (sea snails and sea slugs, *Class*), and 1 Cephalopoda (octopuses, squids, cuttlefish, nautilus, *Class*);
- Annelida (7): 7 Polychaeta (polychaete worms, *Class*);
- Cnidarians (15): 9 Hydrozoa (hydroids, *Class*), 3 Scyphozoa (jellyfish, *Class*), and 3 Anthozoa (sea anemones, corals, *Class*);
- Plant (1): *Zostera marina* (eelgrass, *Species*).

$SLC_{50}$  are considered equivalent to  $EC_{50}$  to feed the SSD calculations. In short, the effects identified by Vaquer-Sunyer & Duarte (2008) include:

- Avoidance of hypoxic waters or anoxic sediments, depressed activity, shift to anaerobic metabolism, increased ventilatory water flow, reduced growth, reduced predation rates, lethargy (on fish and crustaceans);
- Reduction of burial depth, climbing on structures (e.g. echinoderms, polychaetes, annelids, crustaceans, gastropods, bivalves, priapulids, and anemones);
- Depression of activity (e.g. echinoderms);
- Reduced feeding activity (e.g. some crustaceans, molluscs, and polychaetes);
- Reduced metabolic rates (e.g. cnidarians) and heartbeat rate (some crustaceans);
- Temporary shifts to anaerobic metabolism (e.g. bivalves, polychaetes, oligochaetes, echinoderms, and some crustaceans).

The representativeness of the reported taxa might be questionable facing all the existing benthic, demersal, and benthopelagic species in marine coastal waters worldwide, but the results compiled in Vaquer-Sunyer & Duarte (2008) represent the most comprehensive dataset available to date.



The geographical distribution of all the 65 species was found on several biology/ecology databases and attributed to their respective large marine ecosystem(s) (LME) and later grouped in climate zones (Tropical, Subtropical, Temperate, Subpolar, and Polar). SSD curves were calculated for the 5 climate zones and for a global zone (results in) based on:

- Polar climate zone: 20 species in 11 LMEs;
- Subpolar climate zone: 33 species in 7 LMEs;
- Temperate climate zone: 55 species in 16 LMEs;
- Subtropical climate zone: 41 species in 13 LMEs;
- Tropical climate zone: 19 species in 17 LMEs;
- Global zone: 65 species in 64 LMEs.

The criteria for the grouping of LMEs into climate zones was primarily its geographic coverage and water temperature:

- Latitudinal distribution: Tropical from Equator to  $\approx 20^\circ\text{N}$ , Subtropical from  $\approx 20^\circ\text{-}30^\circ\text{N}$ , Temperate from  $\approx 30^\circ\text{-}50^\circ\text{N}$ , Subpolar from  $\approx 50^\circ\text{-}70^\circ\text{N}$ , and Polar from  $\approx 70^\circ\text{-}90^\circ\text{N}$  (and the same for the Southern Hemisphere);
- Mean annual sea surface temperature (maSST): based on the information included in the LME briefs (data collection of specific distinctive characteristics) provided by NOAA (2012), where maSST is presented as a dataset extending from 1975-2005 with regression curves fitted to assess variation trends per LME. The individual regression equations were then used to calculate maSST for 2005 for each LME and used to complement the grouping of LMEs into the 5 climate zones (Figure 3.6 in Appendix 3-II);
- To help on the classification of some LMEs, complementary information was found on the MEOW classification system (Spalding et al. 2007) and on the Köppen-Geiger climate classification system (Peel et al. 2007).

Adapting the definitions from Trass et al. (2002) and Larsen & Hauschild (2007) to the present study, the PAF is the fraction of species in a generic ecosystem/community that is expected to be potentially affected above its no-effect level (NOEC) or a predefined effect level for a given intensity of the environmental stressor. The PAF approach assumes that the distribution of the species' sensitivity values ( $EC_{50}$ ) in the SSD methodology can be described by a Probability Distribution Function (PDF), which can be integrated into a Cumulative Distribution Function (CDF) (Larsen & Hauschild 2007).

The Effect Factor (EF, unit:  $\text{PAF}\cdot\text{m}^3/\text{kgO}_2$ ) represents the variation of effect ( $\Delta\text{PAF}$ ) due to a variation of the stressor intensity ( $\Delta[\text{O}_2]$ ) and is calculated as:

$$EF = \frac{\Delta\text{PAF}}{\Delta[\text{O}_2]} = \frac{0.5}{\text{HC}_{50}}$$

Where  $\text{HC}_{50}$  is obtained by calculating  $\text{HC}_{50} = 10^{\log(\text{EC}_{50})}$  or by calculating the geometric mean of the  $\text{EC}_{50}$  data, in accordance to the average gradient method as described by (Pennington et al. 2004).

Traditionally, the aim in ecotoxicology is to estimate the effect of a contaminant. Roughly, the increase in its concentration results in more effect or more organisms/species affected – therefore PAF is used to express that resulting effect. In the present case, where the effects result from hypoxia (i.e. DO depletion), as the DO concentration increases (within a reasonable range) less

effect is expected and more species are 'safe'. This fraction should be seen as the proportion of non-affected fraction of species (or PNAF) where:  $PNAF = 1 - PAF$

The SSD curves and the global results obtained from their analysis can be found in Figure 3.7 through to Figure 3.12 and Table 3.10 in Appendix 3-VII.

### 3.2.6 Normalisation

All environmental emissions from human intervention resulting in nitrogen export to marine coastal waters constitute the relevant inputs to the normalisation phase. As seen before, the identified routes of N emissions to receiving compartments that ultimately build into increased N loadings to the marine system are "N to air", "N to surface freshwater (sfw)", "N to groundwater (gw)", and "N to coastal marine waters (mw)".

Data of N emissions in those routes were obtained from the sources and years indicated in Table 3.2 and multiplied by the respective CFs and then aggregated to find the overall impact score for the selected spatial scale (country, region/continent, or global). This overall impact score is then divided by the population reference (for the respective scale) to find an average impact per inhabitant of the spatial scale used, which constitutes the Normalisation Reference (NR).

Emissions should be divided by NR or multiplied by the Normalisation Factor (NF, for  $NF=1/NR$ ).

Practitioners should apply NRs after aggregation of the impact scores from the different identified emission routes in the inventory, calculated by applying the respective CFs to the LCI emissions. The resulting normalised impact scores can be compared more effectively with other categories, as pointed out by Sleeswijk et al. (2008).

Population data for year 2005 retrieved from UN statistics (UN 2013).

**Table 3.2:** Data sources for the nitrogen emissions per emission route.

Emission routes	Method	Notes on data source
Agriculture N application per country	Bouwman et al. (2009) Van Drecht et al. (2003)	Year 2000. Supplementary material provided in data files by Bouwman (2011a, 2011b)
N exports to fresh- and groundwater	Bouwman et al. (2009) Van Drecht et al. (2003)	Year 2000. Supplementary material provided in data files by Bouwman (2011a, 2011b)
Air emissions as NH <sub>3</sub>	Roy et al. (2012)	Year 2005. Supplementary material provided in data files by Roy (2012)
Air emissions as NO <sub>x</sub>	Roy et al. (2012)	Year 2005. Supplementary material provided in data files by Roy (2012)

Nitrogen emissions from sewage water directly to marine waters is not available, so no normalisation references were calculated.

### 3.2.7 Sensitivity analysis

A sensitivity analysis was performed to identify the parameters of the model with the highest influence on the resulting CFs. The analysis was achieved by changing the selected model parameters and comparing the outcomes ( $CF_{end}$ ) with the otherwise modelled results ( $CF_{start}$ ). The sensitivity of these parameters was assessed separately.

The chosen parameters consisted of the N export fraction ( $f_{exp}$ , a relevant component of the FF term, expressing the N exported to marine waters compared to the total emitted from land and



freshwater systems), the sedimentation rate, the denitrification rate, and the residence time of each of the receiving LMEs (these last three parameters refer to the marine ecosystem and compose the marine-N losses due to sedimentation, denitrification, and advection, completing the FF term together with  $f_{exp}$ ), the Primary Production rate (PP, applied in the NIE term calculations, part of the XF), the Bacterial Growth Efficiency (BGE, applied in the OM:O<sub>2</sub> conversion, also part of the XF), the Volume Correction Coefficient (VCC, also part of the XF), and the HC<sub>50</sub> value (the damage dimension of the EF).

All the parameters were independently increased by 10% and the Sensitivity Ratios (SR) calculated by:

$$SR_X = \frac{(CF_{end} - CF_{start})/CF_{start}}{(X_{end} - X_{start})/X_{start}}$$

Where  $CF_{start}$  is the original CF calculated (also referred as modelled CF),  $CF_{end}$  is the CF obtained after increasing parameter  $X$ ,  $X_{start}$  is the original value for the studied parameter, and  $X_{end}$  is the final value of the changed parameter (Strandesen et al. 2007).

### 3.2.8 Uncertainty analysis

The nitrogen export from a country to multiple receiving LMEs may range from null to total export. The present model uses an even split rule in the estimation of the FF by dividing  $f_{exp}$  by the number of receiving LMEs. The range of variation of the N-export for multiple LMEs, as a source of uncertainty, was calculated for the extreme values (minimum and maximum  $f_{exp}$ ) to each of the receiving LMEs. Only the countries exporting to multiple LMEs were tested.

The N-losses terms for sedimentation, denitrification, and advection, together constitute the nitrogen degradation rate (see Section 3.2.3) in the marine compartment, hence it is a critical term for the estimation of CFs. From their correct estimation much depends the confidence on the CFs and the overall model.

To test the possible propagation of the uncertainty associated with the marine-N loss rate, the sedimentation rate, denitrification rate, and residence time were varied to the lower and upper limits of their possible variation range based on the criteria shown next:

- The global average sedimentation rate was varied from 5% (average for coastal areas and estuaries compiled by Nixon et al. 1996) to 8% (as for the North Atlantic also reported by Nixon et al. 1996);
- The global average denitrification rate was varied from 30% (reported by Van Drecht et al. 2003) to 52.7% (reported by Wollheim et al. 2008);
- The residence time was varied for every receiving marine ecosystem (LME) either based on the variation of reported estimations/calculations in literature, using residence times of the lower and upper archetypes, or when that was not possible or reasonably probable (based on the depth, width, and currents exposure characteristics of each LME) on -50% of the used residence time (for the lower limit) or +50% (for the upper limit), or a mix of these options. All the used criteria are shown in Table 3.11 in Appendix 3-VIII.

BGE was varied from 0.01 to 0.69 following the variation range published by del Giorgio & Cole (1998).

Primary Production (PP) is an important parameter to calculate the NIE term and the XF. The uncertainty of this parameter is inherently associated with its estimation method (depth integrated PP rate based on chlorophyll pigment concentration as derived from SeaWiFS satellite remote sensing data and photosynthetically active radiation, as described by Sherman & Hempel (2009) or 'Sea Around Us' Project @ <http://www.searoundus.org/lme/>). The uncertainty of the various models applied to deliver the PP rates is not clearly reported and the effort to assess the resulting combined uncertainty is fairly large. Additionally, after comparing PP rates produced by the two sources mentioned above, significant variations of PP for the same ocean areas (LMEs) were found. These discrepancies were also found highly inconsistent from an expert judgment perspective when analysing the data. In this sense, the PP rates values used in the present model are classified as highly uncertain. The PP rates reported in the 'Sea Around Us' Project's database were used in the present model as they were the least inconsistent.

The Volume Correction Coefficient (VCC) is a model decision-based parameter. The choice of defining 30 meters for the photic zone depth and 0.3 m for the benthic habitat height is described in Section 3.2.4. The uncertainty associated with using average thicknesses for these two layers is classified as low. The effort required to reduce the uncertainty on this parameter would involve the assessment of light penetration depths and continental platform's depth profile for all the LME (or categories of LME) for the photic zone, and continental platform's depth profile, bottom profile, type of substrat, typical resident benthic species, and more, for the benthic habitat height. It is recognised that the required effort exceeds the potential benefits, and therefore the use of the mentioned average figures are adopted and the uncertainty set to low.

### **3.3 Results**

#### **3.3.1 Fate Factors (FF)**

The results of the Fate Factors (FF) estimations are included in Table 3.12 in Appendix 3-IX.

#### **3.3.2 Exposure Factors (XF)**

The results of the Exposure Factors (XF) estimations are shown in Table 3.13 in Appendix 3-X.

#### **3.3.3 Effect Factors (EF)**

The results of the Effect Factors (EF) estimations are included in Table 3.14 in Appendix 3-XI.

#### **3.3.4 Characterisation Factors (CF)**

The results of the Characterisation Factors (CF) estimations per emission rate and at Country-to-LME and Country scales can be found in Table 3.15 in Appendix 3-XII, and per emission route with reference N emissions at the various scales in Table 3.16 through to Table 3.23 in Appendix 3-XII. Aggregated results for the region/continent and global scales are included in Table 3.24 through to Table 3.27 in Appendix 3-XIII.

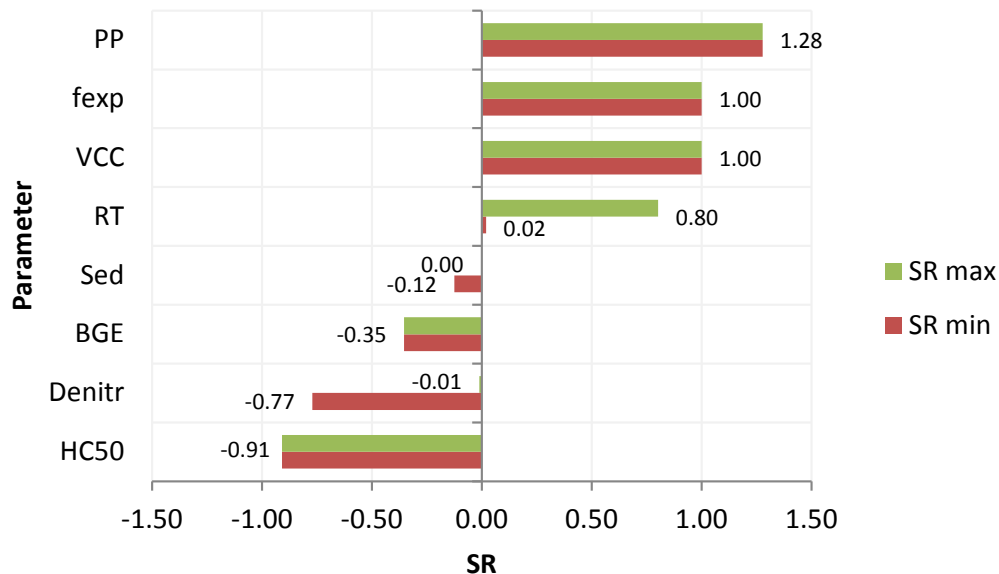
### 3.3.5 Normalization References (NR)

Normalisation References were calculated and included in Table 3.28 for the country-to-LME scale, in Table 3.29 for the country scale, and Table 3.30 for the region/continent and global scales (Appendix 3-XIV).

For practical reasons practitioners may find useful to normalise results at the country-to-LME scale, especially when the emission location is well defined within this scale. For this purpose, the relevant NRs are included in Table 3.28 assuming a simple country population even split by the number of possible receiving LMEs. Improvements can be added here by estimation a more accurate number of inhabitants on the relevant emitting region to that LME.

### 3.3.6 Sensitivity test

The sensitivity ratio (SR) results (Figure 3.3) are equal for any considered N emissions route (“N to air”, “N to sfw”, “N to gw”, and “N to mw”), so the results are generically shown per varying parameter.



**Figure 3.3:** Sensitivity analysis results: Sensitivity Ratios (SR) for the tested parameters: Primary Production (PP), N-export fraction ( $f_{exp}$ ), Volume Correction Coefficient (VCC), residence time (RT), sedimentation rate (Sed), Bacterial Growth Efficiency (BGE), denitrification rate (Denitr), and effect component of the EF (HC50).  $SR_{max}$  and  $SR_{min}$  represent the upper and lower limit of the variation of the results obtained.

A negative SR value indicates that input and output are inversely related, i.e. increasing the input value will decrease the output value (Strandesen et al. 2007) and the absolute values show the impact contribution of the parameter to the model outputs.

The SR(PP) of 1.28 means that output (CF) is highly sensitive to the input parameter and therefore the uncertainty associated with the input parameter is amplified at the CF level contributing to a larger uncertainty there, and lower confidence on the results. This amplification

is given by the exponential effect introduced in the NIE calculation (where PP is applied) affecting the resulting CF (see NIE equations in Section 3.2.4)

The  $SR(f_{exp})$  and  $SR(VCC)$  (both equal to 1.00) show that the output vary in the same proportion as the variation applied to the input data, revealing that the CFs are insensitive to these parameters. This fact is expected as both parameters are applied linearly as simple multiplication terms in the calculations of the CFs.

The SR results for the three parameters composing the marine-N loss rate coefficient (sedimentation, denitrification, and residence time) show very low contribution of the sedimentation rate, and low contribution of denitrification and residence time (below the neutral contribution of 1.00). This fact is explainable by the low values used for the sedimentation and denitrification rates (5% and 30%, respectively). Even though, the RT term is the one originating the variability of the FF and, the high variation of  $SR(RT)$  and  $SR(denitr)$  is mostly depending on the productivity of the receiving LME (differentiation given by the PP and NIE values).

The  $SR(BGE)$  and  $SR(HC50)$  results show that these parameters do not contribute significantly to the CF, as it falls below the neutral contribution of  $SR=1.00$ , and that its uncertainty is propagated equally to the results of any of the receiving ecosystems.

### 3.3.7 Uncertainty estimation

The variation range of the possible N-export scenarios (from null export  $f_{exp}=0$ , through to total export  $f_{exp}=\text{country N export}$ , to each of the multiple receiving LMEs) expresses the uncertainty associated with this model choice. The model estimation uses an even-split rule from one country to multiple LMEs. The uncertainty of the term, which is used to calculate the FF, is quantified by calculating the extreme values of the possible outcome of the CFs (when the even-split rule is not adopted) per emission route and only for the countries exporting to multiple receiving LMEs. The results are included in Table 3.32 (Appendix 3-XV) and note that the variation range (i.e. uncertainty) is logically in direct proportion to the number of possible receiving LMEs.

The extreme values of uncertainty of the marine-N loss rate were also calculated by applying the combined upper (lower) limits of the sedimentation and denitrification rates and the lower (upper) limit of the residence time simultaneously to estimate the impact of applying a maximised (minimised) N-loss rate to obtain the lowest (highest) set possible of CFs, i.e. the lower (upper) limit of the uncertainty range for the resulting CFs for each combination of Country-to-LME. The results are shown in Table 3.33 (Appendix 3-XV) and the (CF variation weighted) average of variation due to RT is ca. 0.82 (82%). The uncertainty range thus calculated expresses the best-case and worst-case scenarios of the potential impacts to marine eutrophication from anthropogenic N-emissions, based on the present modelling framework for even-splitting of countries N emissions to multiple receiving coastal ecosystems.

The uncertainty associated with the BGE parameter was tested with the estimation of the variation range of the extreme values of BGE contributing to the XF term. The published BGE data values (del Giorgio & Cole 1998) represent a possible range of scenarios for receiving ecosystems and were adopted here as obtaining/finding individual LME BGE values is not feasible. The results are shown in Table 3.34 (Appendix 3-XV) and the (CF variation weighted) average of variation due to BGE is ca. 0.92 (92%).

### 3.4 Discussion

The present damage model is built on the use of explainable natural ecological processes (biogeochemical) supporting a LCIA methodology to make them useful for practical applications. Correlating nitrogen inputs and primary production in marine ecosystems at a midpoint level, and degradation of organic matter and oxygen depletion to statistically significant effects on marine organisms at an endpoint level, is intended to draw the basis for an endpoint characterisation method and a way to address management options as a decision-support tool.

#### 3.4.1 Estimations and modelling

The link between FF and XF assumes an incorporation of nitrogen into phytoplankton biomass. As nitrogen loadings are used to estimate the nitrogen present in the water mass it is also assumed that the nitrogen availability to primary producers is fairly constant in the input forms, i.e. the fraction of bioavailable forms in the Total-N input should be constant for all the receiving ecosystems (LME). The significance of this assumption involves potential different loss rates or flushing times for different forms, with resulting overestimations of primary production (and subsequent nitrogen incorporation, biomass produced, oxygen consumed, and effect on biota).

In the estimation of nitrogen losses, it seems that net sedimentation (or burial) is generally a small fraction (Hinga et al. 1995) while denitrification appears to be a critical term. Studies have shown that denitrification can exceed the sum of land fluxes and atmospheric deposition (Nixon et al. 1996) and that the negative net balance of anthropogenic nitrogen is compensated by deeper ocean waters (upwelling). This extra input brings into the study systems an amount (or loading) of nitrogen whose source (natural or anthropogenic) cannot be defined (although primarily natural might seem right). Therefore the primary production and organic matter posteriorly degraded has a potential non-anthropogenic source, which should not be covered by the LCIA model.

Furthermore, the systems' dynamics governing the residence time may also have a unquantified influence on the nitrogen losses by denitrification. In principle, highly dynamic ecosystems show a shorter residence time and thus less time for denitrification processes to take place, as less nitrogen sinks to bottom sediments. On its turn, oxygenation by vertical mixing of the bottom benthic layer (right above the sediment) also contributes to lower denitrification rates. Inversely, low dynamic ecosystems potentially show higher denitrification rates due to longer residence times and less oxygenation of the bottom waters due to stratification. In the present model, nitrogen losses are individually modelled as denitrification-, net sedimentation-, and advection-driven, thus only the latter is dynamics-dependent, and no other influence is included, especially to the denitrification rate (which is assumed constant for all LMEs). Applying differentiated denitrification rates to the model would contribute to improve the spatial differentiation of the FF (and sedimentation rate likewise but with a lower impact on the results).

No temporal differentiation is included in the damage model. The occurrence of hypoxia conditions after the spring and autumn algal blooms, allied to temperature and nitrogen availability, and the seasonality of phytoplankton growth due to light and temperature patterns, especially at higher latitudes, suggest differentiated damage patterns over an annual cycle. Although very relevant for management purposes, also due to the seasonal patterns of the nitrogen loadings (e.g. application of fertilizers in agriculture, or atmospheric deposition profiles),

the aim of the present model is to focus on the average annual fluxes and impact scenarios. This means that loadings are treated as evenly spread over time, and severe hypoxia (and possibly anoxia) due to extreme point consumption of DO are avoided by dispersion of oxygen consumption figures over time.

In the same line, specific local conditions favouring extreme DO depletion in bottom waters are avoided by assuming an evenly distribution of oxygen consumption within the benthic layer volume. This simplification may bring significant underestimations on localized damage to biota, and may pose relevant management consideration in terms of water quality.

### **3.4.2 The biogeographical classification system**

The LME biogeographical classification system was chosen based on the advantages discussed in Section 3.4.2. Even though other classification systems can be used in the present damage model, the data availability, the modelling feasibility, and the size (and number) of other spatial units may bring unnecessary work or uncertainty to the modelling and spatial differentiation.

### **3.4.3 Issues concerning biological data**

The Fate Factors are built on SSD curves based on a limited number of SLC<sub>50</sub> results. This dataset is composed of only 65 species distributed unevenly by the 5 considered climate zones. In fact, this constraint is the reason for the necessity of adopting the climate zones grouping, as some of the LME show no occurring species.

The limited dataset may also contribute to low representativeness of the sampled species and reduce validity of the EF estimations. The sensitivity to hypoxia results compiled in the dataset and the SSD methodology may also raise questions regarding the equal weight given to abundant and rare species, the dominance of some groups over others (e.g. 15 fish species vs. 1 plant species) the dominance of diversity of some climate zones (e.g. 55 species in 16 temperate climate LMEs vs. 19 species in 17 tropical climate LMEs), the dominance of species that can be reared or survive in laboratory conditions, the dominance of more abundant species, or the skewed distribution of species due to the location and resources of laboratory facilities or research groups.

### **3.4.4 Comparison with existing and recommended methods**

From the analysis of the existing characterisation methods, the present proposed method shows up as the only including both airborne and waterborne emissions fate models with spatial differentiation at individual country level and global applicability.

The proposed model uses the N increase in marine waters as midpoint indicator, like ReCiPe for marine eutrophication or EDIP2003 for aquatic eutrophication, but it is not limited to European emissions (like ReCiPe is) and it is dedicated to marine eutrophication (while EDIP2003 is generic for aquatic eutrophication).

The proposed endpoint characterisation includes species diversity loss as the endpoint indicator and (presently) provides CFs for 143 countries and 6 nitrogen emissions routes, and CFs for 214 individual Country-to-LME spatial combinations rendering an extensive coverage and spatial representativeness, as well as different ecosystem types and local/regional environmental



conditions. The number of CFs can grow to include more countries and further Country-to-LME providing that national emission rates are found/turned available and data processed.

A further application of the model results could be the aggregation of impacts per receiving LME, where estimations of the damage to each LME would integrate contributions from different countries (multiple countries to each receiving LME instead of each country to multiple receiving LMEs). The information thus obtained would be mostly aimed at ecosystem protection.

### 3.4.5 Analysis of the spatial differentiation of the Characterisation Factors (CF)

After the estimation of CFs aggregated at a country level, an analysis was conducted to assess the countries with the highest and the lowest CF per emission route. The top 10 countries for each of the nitrogen emission routes are shown below (Table 3.3), and the bottom 10 countries are shown next (Table 3.4). In these sets of tables is also included a short note on the analysis of the parameters dominating the high or low CF results.

**Table 3.3:** Countries showing the highest 10 Characterisation Factors (CF) and analysis of the parameters possibly governing such high rankings, per nitrogen emission route.

Emission route: <b>N to Air</b>			Emission route: <b>N to sfw</b>		
Spatial scale: Country			Spatial scale: Country		
Top10 CFs	PAF.m3.d/kgN	Receiving ecosystem's features	Top10 CFs	PAF.m3.d/kgN	Receiving ecosystem's features
Finland	38,643.28	high $f_{exp}$ ; RT=25yr; NIE=4.1 (highest)	Russian Federation	99,924.93	Comb high RT+NIE for LME 50, 52, 62
Estonia	38,535.67	RT=25yr; NIE=4.1 (highest)	Denmark	93,854.51	avg RT=9.1yr; avg NIE=2.3
Latvia	35,828.36	RT=25yr; NIE=4.1 (highest)	Germany	92,574.02	avg RT=13.5yr; high avg NIE=3.1
Poland	35,107.62	RT=25yr; NIE=4.1 (highest)	Sweden	92,574.02	avg RT=13.5yr; high avg NIE=3.1
Lithuania	33,510.99	RT=25yr; NIE=4.1 (highest)	Switzerland	73,923.07	high avg RT=60.1yr; avg NIE=1.5
Belarus	29,863.38	RT=25yr; NIE=4.1 (highest)	Belarus	71,378.35	RT=25yr; NIE=4.1 (highest)
Sri Lanka	25,932.46	high $f_{exp}$ ; avg RT=12yr; avg NIE=1.2	Estonia	71,378.35	RT=25yr; NIE=4.1 (highest)
Oman	21,274.65	avg RT=6.5yr; high avg NIE=1.98	Finland	71,378.35	high $f_{exp}$ ; RT=25yr; NIE=4.1 (highest)
Sweden	21,154.72	avg RT=13.5yr; high avg NIE=3.1	Latvia	71,378.35	RT=25yr; NIE=4.1 (highest)
United Arab Emirates	20,715.44	avg RT=6.5yr; high avg NIE=1.98	Lithuania	71,378.35	RT=25yr; NIE=4.1 (highest)

Emission route: <b>N to gw</b>			Emission route: <b>N to mw</b>		
Spatial scale: Country			Spatial scale: Country		
Top10 CFs	PAF.m3.d/kgN	Receiving ecosystem's features	Top10 CFs	PAF.m3.d/kgN	Receiving ecosystem's features
Russian Federation	35,377.15	Comb high RT+NIE for LME 50, 52, 62	Russian Federation	211,257.79	Comb high RT+NIE for LME 50, 52, 62
Denmark	33,227.99	avg RT=9.1yr; avg NIE=2.3	Denmark	198,423.91	avg RT=9.1yr; avg NIE=2.3
Germany	32,774.65	avg RT=13.5yr; high avg NIE=3.1	Germany	195,716.75	avg RT=13.5yr; high avg NIE=3.1
Sweden	32,774.65	avg RT=13.5yr; high avg NIE=3.1	Sweden	195,716.75	avg RT=13.5yr; high avg NIE=3.1
Switzerland	26,171.52	high avg RT=60.1yr; avg NIE=1.5	Switzerland	156,285.57	high avg RT=60.1yr; avg NIE=1.5
Belarus	25,270.60	RT=25yr; NIE=4.1 (highest)	Belarus	150,905.61	RT=25yr; NIE=4.1 (highest)
Estonia	25,270.60	RT=25yr; NIE=4.1 (highest)	Estonia	150,905.61	RT=25yr; NIE=4.1 (highest)
Finland	25,270.60	high $f_{exp}$ ; RT=25yr; NIE=4.1 (highest)	Finland	150,905.61	high $f_{exp}$ ; RT=25yr; NIE=4.1 (highest)
Latvia	25,270.60	RT=25yr; NIE=4.1 (highest)	Latvia	150,905.61	RT=25yr; NIE=4.1 (highest)
Lithuania	25,270.60	RT=25yr; NIE=4.1 (highest)	Lithuania	150,905.61	RT=25yr; NIE=4.1 (highest)

The high ranking of CF results of the countries showed above is justified by the dominance of the effect of high residence times in the estimation of the marine N-loss rate, and high productivity (seen from the very high NIE value), meaning that nitrogen is kept within the ecosystem long enough to promote biomass production either by long availability or by several

reuse cycles (suspension, incorporation, mineralization, and resuspension). As the CFs are resulting from the varying effect of N-export fraction and HC50 (apart from the residence time and NIE already mentioned) smaller variations of the CFs (and rankings) may also be explained by the combination (with cumulative effect) of the various parameters without necessarily showing one that dominates the estimation.

Overall, countries exporting N to the Baltic Sea and the Black Sea show the highest CFs and tend to occupy the top ranks for all the emission routes. For the atmospheric deposition route (“N to air”) there is a further influence of the export fractions (more deposition) in some of the top ranks ( $f_{air\ Finland}=0.750$  and  $f_{air\ Sri\ Lanka}=0.579$ , above the average  $f_{air\ avg}$  of 0.313).

The practical meaning of analysing the CFs results is to identify patterns in the geographical location (see figure ) and possible explanations for a potential high prevalence in specific regions that ultimately quantifies the impact of a potential increment in the nitrogen emissions from those countries.

**Table 3.4:** Countries showing the lowest 10 Characterisation Factors (CF) and analysis of the parameters possibly governing such low rankings, per nitrogen emission route.

Emission route: <b>N to Air</b>			Emission route: <b>N to sfw</b>		
Spatial scale: Country			Spatial scale: Country		
Bottom10 CFs	PAF.m3.d/kgN	Receiving ecosystem's features	Bottom10 CFs	PAF.m3.d/kgN	Receiving ecosystem's features
Belize	1,097.00	RT=0.21yr; NIE=0.7	Dominican Republic	1,163.28	RT=0.21yr; NIE=0.7
Nicaragua	1,070.72	avg RT=0.23yr; avg NIE=0.9	Haiti	1,163.28	RT=0.21yr; NIE=0.7
Guatemala	1,007.93	avg RT=0.23yr; avg NIE=0.9	Honduras	1,163.28	RT=0.21yr; NIE=0.7
Brazil	974.66	avg RT=0.25yr	Jamaica	1,163.28	RT=0.21yr; NIE=0.7
Venezuela	874.99	RT=0.21yr; NIE=0.7	Puerto Rico	1,163.28	RT=0.21yr; NIE=0.7
Colombia	809.98	avg RT=0.23yr; avg NIE=0.9	Venezuela	1,163.28	RT=0.21yr; NIE=0.7
Australia	550.68	avg RT=0.25yr; avg NIE=0.8	New Caledonia	966.37	RT=0.25yr; NIE=0.5
Chile	369.57	low RT (0.03 - lowest)	Bolivia	422.52	low RT (0.03 - lowest)
Peru	301.05	low RT (0.03 - lowest)	Chile	422.52	low RT (0.03 - lowest)
Bolivia	214.72	low RT (0.03 - lowest)	Peru	422.52	low RT (0.03 - lowest)

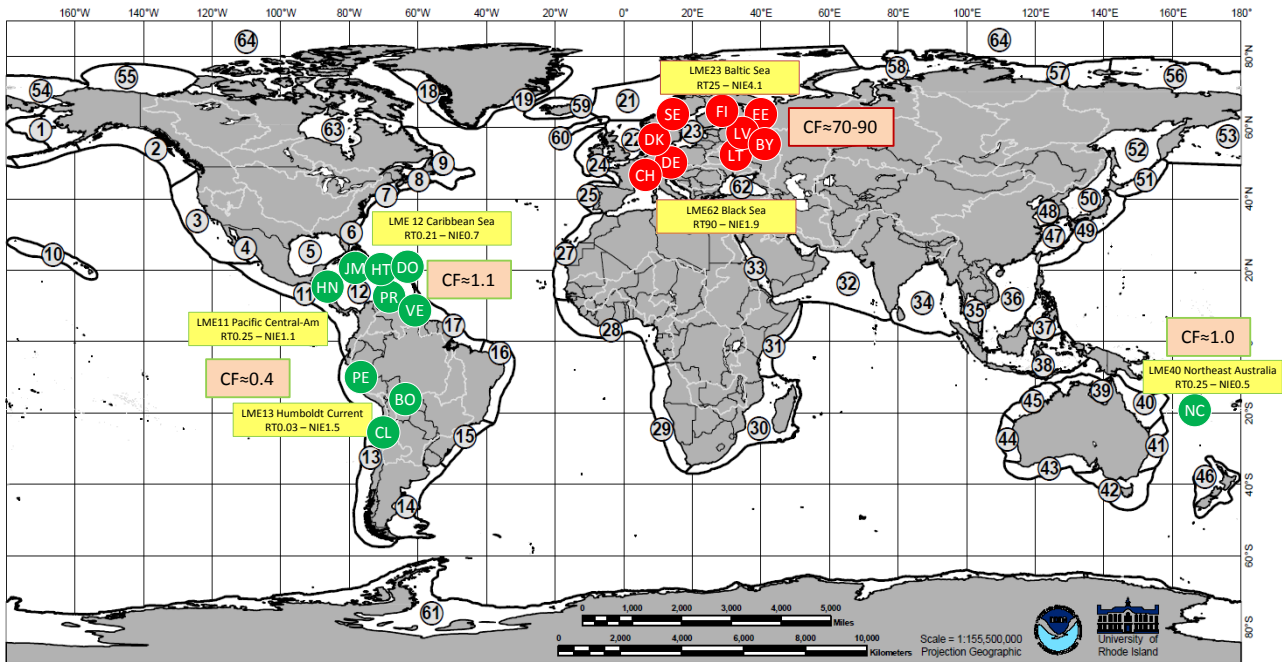
Emission route: <b>N to gw</b>			Emission route: <b>N to mw</b>		
Spatial scale: Country			Spatial scale: Country		
Bottom10 CFs	PAF.m3.d/kgN	Receiving ecosystem's features	Bottom10 CFs	PAF.m3.d/kgN	Receiving ecosystem's features
Dominican Republic	411.84	RT=0.21yr; NIE=0.7	Dominican Republic	2,459.37	RT=0.21yr; NIE=0.7
Haiti	411.84	RT=0.21yr; NIE=0.7	Haiti	2,459.37	RT=0.21yr; NIE=0.7
Honduras	411.84	RT=0.21yr; NIE=0.7	Honduras	2,459.37	RT=0.21yr; NIE=0.7
Jamaica	411.84	RT=0.21yr; NIE=0.7	Jamaica	2,459.37	RT=0.21yr; NIE=0.7
Puerto Rico	411.84	RT=0.21yr; NIE=0.7	Puerto Rico	2,459.37	RT=0.21yr; NIE=0.7
Venezuela	411.84	RT=0.21yr; NIE=0.7	Venezuela	2,459.37	RT=0.21yr; NIE=0.7
New Caledonia	342.13	RT=0.25yr; NIE=0.5	New Caledonia	2,043.07	RT=0.25yr; NIE=0.5
Bolivia	149.59	low RT (0.03 - lowest)	Bolivia	893.27	low RT (0.03 - lowest)
Chile	149.59	low RT (0.03 - lowest)	Chile	893.27	low RT (0.03 - lowest)
Peru	149.59	low RT (0.03 - lowest)	Peru	893.27	low RT (0.03 - lowest)

From the analysis of the CF results and the different parameters contributing to the lowest 10 rank positions, Peru, Chile, and Bolivia consistently show the lowest CFs. All the lowest CF rank positions are taken by countries exporting nitrogen to very dynamic ecosystems, with low capacity of retaining nitrogen long enough to promote high biomass production or total use of the supplied N forms. This fact reveals the influence of the residence time and the productivity of the receiving ecosystems in the model results and the critical relevance of the nitrogen losses/use in the marine



compartment. This assessment, together with the sensitivity analysis and the uncertainty quantification (discussed ahead) contributes to find key issues.

Again, by analysing patterns in the distribution of low CF countries and understanding the most probable reasons for such results may help mapping critical regions and categorize coastal ecosystems regarding their potential capacity to withstand the effect of eutrophying nitrogen loadings, as they show little impact from incremental N emissions.



**Figure 3.4:** Spatial differentiation of the model results – example of the geographical distribution of the countries showing the Top10 (red) and Bottom10 (green) Characterisation Factors (CFs) for source emissions to surface freshwater (cf. Table 3.3 and Table 3.4). Distribution pattern is similar to emissions to groundwater and marine water, but CF values vary. **CF unit =  $\times 10^3$  PAF·m<sup>3</sup>·d/kgN.**

The geographical distribution showed in Figure 3.4 points to a concentration of high potential impacts from countries exporting nitrogen to receiving ecosystems with longer residence time and higher productivity, and lower potential impacts from countries exporting to highly dynamic (low residence time), low productivity, or a combination of both.

### 3.4.6 Normalisation References (NR)

Normalisation is an optional step in LCIA (ISO 14044:2006) and provides a way to meaningfully compare impact scores of different impact categories.

The calculated normalisation references (NR) are available at the country-to-LME (214), country (143), region/continent (13), and world (1) scale, and depending on the scale practitioners are working with the characterised scores, the NRs can be applied to obtain normalised impacts for marine eutrophication.

### 3.4.7 Environmental relevance, completeness, and consistency

The present model integrates a river-N fate model, a marine-N fate model, a NIE environmental model (included in the exposure model) and an Effect component built on experimental SLC<sub>50</sub> and statistical SSD curves. The integration of these various components forms a comprehensive damage model that covers all the recognisable involved biogeochemical processes. It is fed by sufficient data, although some provided by external models for emission or deposition, with no significant assumptions that hinder interpretation.

The N loss processes and the NIE modelling components bring environmental relevance to the results. Additionally, the model provides CFs for 4 different emission routes widening its relevance and applicability. Although some minor data gaps are identifiable these do not hamper the CFs estimation, e.g. national N emissions missing resulting in some countries not being accounted in the CF calculations, or denitrification and leaching rates to river missing for 52 countries (hence not included), or the use of an average river denitrification rate instead of spatially differentiated rates.

In what regards to data consistency, the N emissions, leaching, and export to sfw are based on the IMAGE 2.4 model for the year 2000, and the atmospheric N-fate deposition of NH<sub>3</sub> and NO<sub>x</sub> used a dataset simulated for year 2005, normalisation references were calculated from 2005 population data, and some other assorted data, e.g. maSST data (2005) for the climate zone grouping, and PP data from SeaWiFS remote sensing (monthly averages from 1997-2004) were also used.

The most relevant inconsistency is found in the 5-years discrepancy between the agriculture model governing the exports to sfw and gw (by Bouwman 2011a, 2011b), and the atmospheric depositions model governing export data soil, sfw and mw (by Roy 2011; Roy et al. 2012). Nevertheless, this discrepancy is expected to have a minor impact in the results.

### 3.4.8 Sensitivity and uncertainty

The assumption of an even split of the N-export ( $f_{exp}$ ) when dealing with countries with N exports to multiple LMEs is a simplification of a complex estimation. It can be seen as a model choice and different scenarios may arise from choosing other export splitting rules. The uncertainty raised from the range of possible CF outcomes when testing the minimum and maximum CF scenarios variation (Table 3.32 in Appendix 3-XV) was found as of medium uncertainty, as the range can be estimated, but the true splitting rule is unknown. However, it is possible to improve the estimation of this term by considering several factors. Possible approaches may include the estimation of the area, volume, and discharge points of all the national watersheds, in order to determine the potential N loadings received from agricultural and natural land being leached (by surface and groundwater) to rivers, the potential atmospheric deposition on that land area and directly into surface freshwater, the use of country-specific individual or averaged denitrification rates on topsoil and freshwater systems, to ultimately know the amount of nitrogen being exported from a particular country to a specific receiving LME. Additionally, improved estimations of N emissions may also be assigned to different regions in the country based on the local concentration of industrial or agricultural activities. The complexity and feasibility of these estimations may vary from country to country depending on the availability of

data and national statistics, but overall it is definitely highly time- and resources-consuming (effort), hence the need for the above mentioned simplification.

The impact of using split N  $f_{\text{exp}}$  is particularly significant when the receiving LMEs show different marine-N loss rates combined with highly distinct NIE (due to different productivity rates). Countries exporting nitrogen to LMEs exposed to similar conditions, e.g. to contiguous LMEs in fairly similar coastal conditions may show minor variations in the resulting CFs (then the N-loss rates are dictated the residence time and the environmental conditions governing the NIE term). In some cases, however, high variation of the CFs may show if significantly different residence times and NIE occur. Once again, the impact of the N exported (or the certainty of the N-export splitting rule) is very important here.

An example of the uncertainty of exporting to significantly different LMEs can be built for Denmark, with discharges to both the North Sea (to the West) and the Baltic Sea (to the East). Both LMEs share the same sedimentation and denitrification rates (because average rates are used) but show significantly different residence times (2 yr for the North Sea vs. 25 yr for the Baltic Sea) and therefore different N-loss rates (and FFs) are expected. In addition, the NIE term is also significantly different (2.075 vs. 4.095 respectively, due to higher productivity in the Baltic Sea resulting in different XFs). While the EFs show similar figures, after applying the FF and XF the resulting CFs are significantly different (3.4 times higher for exports to the Baltic Sea).

Furthermore, the inclusion of the Faroe Plateau (LME#60) on the Danish statistics induces an overestimation of the CFs there (and underestimations to the North and Baltic Seas CFs). While the model estimation is delivering equal FFs for all the three receiving LMEs (North Sea, Baltic Sea, and Faroe Plateau) an improved N-export splitting rule would reflect the different loadings and LME conditions in the FF instead (with much fewer emissions to be assigned to the Faroe Plateau). This example points to possible refinements of the model and in particular to the FF estimation. Using the even split exports' method LME#60 is receiving one third of the Danish N-exports, which is not only incorrect but also unrepresentative for the potential impacts to marine eutrophication from the actual local activities.

Similarly to the example given for Denmark, finding the correct splitting of N exports for e.g. Japan, Morocco, or Saudi Arabia would also improve the results, as these countries N-export to LMEs with highly distinct N-loss rates due to local residence time (Japan, varying from 0.25-25 yr, Morocco, varying from 0.25-90 yr, and Saudi Arabia varying from 6.5-40 yr). More countries can be found with such variations and all the 34 countries exporting to multiple LMEs should be reviewed and the individual  $f_{\text{exp}}$  improved.

In opposition, countries like Norway or Australia split the N export to multiple LMEs with equal residence time (2 yr and 0.25 yr, respectively) and where only the NIE term varies (0.737-2.075 and 0.495-1.584, respectively) due to local productivity rates, and  $\text{HC}_{50}$  (1.357-1.611  $\text{mgO}_2/\text{L}$  for both countries) reflecting the climate zones grouping. In these cases the N-export splitting rules are not affecting the FF but only the XF and EF terms.

These examples and their discussion, extendable to several other point issues, show the importance of improving the estimations of national N exports to multiple receiving LMEs (especially relevant when these bear significantly different characteristics).

As mentioned, uncertainty quantification in the estimation of CFs indicates the confidence on the model results. The combination of uncertainty assessment and the sensitivity analysis should provide an overview of the key issues of the model and the critical aspects for improvement, by

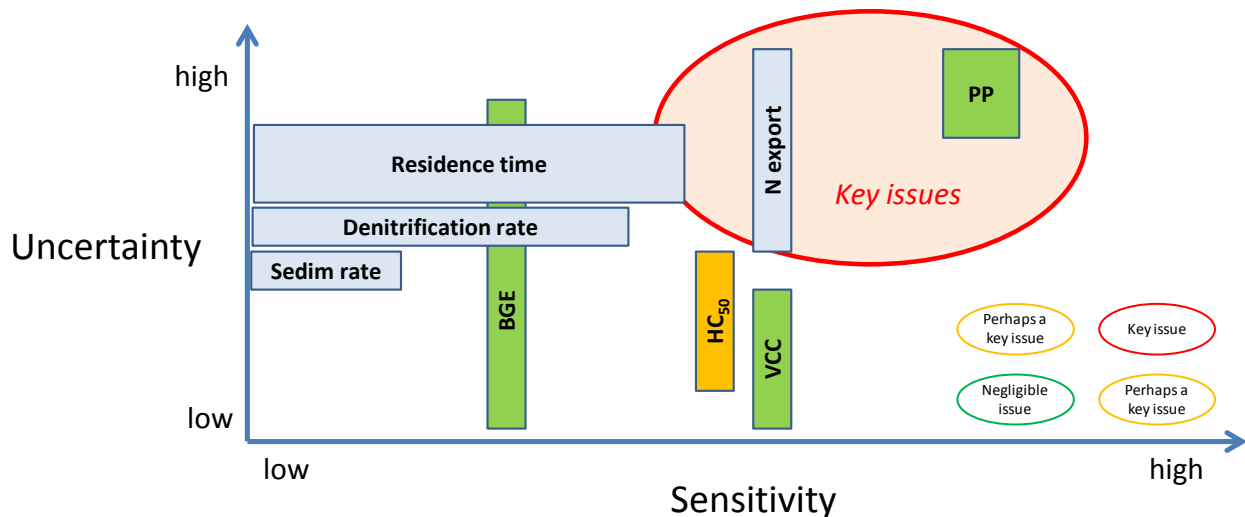
identifying the most relevant parameters for possible refinements on an effort investment-return basis, to ultimately improve transparency and robustness of the overall model.

The model refinements may involve:

- Improving data quality, either at data collection phase (quality and efficiency) or changing/improving the way to estimate non-existing data;
- The choices made within the model, such as compartment boundaries (e.g. depth of photic zone or benthic habitat) and biogeographical zonation systems (e.g. LME, MEO, others), or sources and type of data to use (e.g. measured or estimated);
- Improving certainty of the model components (or sub-models), such as modelling river-N fate, N-losses in the marine compartment, exposure, or effects.

### Key issues

The combination of the sensitivity and the uncertainty analyses results in the identification of the key issues of the present model framework (Figure 3.5), which can point to the best options for improvement.



**Figure 3.5:** Combined analysis of sensitivity and uncertainty for the model input parameters. Components of the FF (light blue), XF (green), and EF (yellow) depicted.

The PP meta-data is of major importance on the CFs estimation both due to possible high sensitivity (SR) and high variability of the reported values.

The parameters governing the marine-N loss rate are considered “perhaps a key issue” due to the uncertainty found when searching for averaged rates of sedimentation and denitrification, to the variation of published residence times for several of the LMEs, and the uncertainty that comes from using archetypes for some others, despite the low sensitivity assigned. However, the residence time is important for the CF results, as seen in Section 3.4.5.

The estimation of HC<sub>50</sub> (and the EF) may be improved if the EC<sub>50</sub> dataset is expanded. Using only 65 species to support such a damage model may underestimate some taxa and overestimate others. Worth of note is the fact that climate zones were included due to the low number of

species representativeness on several of the LMEs. Assigning EFs per climate zone comes with a non-quantified uncertainty that might conceal a significant effect on the CFs.

The significance of the issues identified should be addressed and data quality improved for the most relevant ones. Considering the effort required to achieve an overall improvement of data quality and uncertainty reduction:

- Finding the correct PP dataset would require a low investment by consulting the appropriate experts and assessing the methods to its calculation;
- Improving data quality for the estimation of specific VCC (photic zone and benthic layer boundaries) for each of the LMEs and to estimate LMEs average residence times would be time-consuming to search for available and confident datasets, but returning a good accuracy improvement of the results;
- Improving the sedimentation and denitrification rates estimation would require a large effort, as these rates vary with local conditions and specificities of the involved systems as diverse as temperature, organic content, type and geochemistry of the sediments, influence from estuaries, currents, and others. Additionally, the return of such high investment would be affected by a low sensitivity of the parameters to the model output;
- Expanding the EC<sub>50</sub> dataset to improve the EF estimation would require a major investment in time- and resources-consuming extensive experimental laboratorial work.

Overall, PP should be prioritized in the data quality improvement due to high contribution to the CF (sensitivity) and associated uncertainty. Residence time has been found as a possible issue but its high uncertainty and the relevance in governing marine-N losses, which is critical to the FF, makes it a target for improvement. An important note should be addressed to the N-export splitting rules, considering high relevant to the model. The overall model is supported by the output of terrestrial, freshwater, and atmospheric fate models for which no uncertainty was quantified. To several of the parameters of these 'third-party' models, average rates (related to e.g. leaching, denitrification, volatilisation) are applied when individual and more adequate rates should be developed to better reflect the spatial differentiation. The BGE term may also be improved by adding spatial differentiation, as only an average value was used in the model.

The importance of understanding and improving the spatial differentiation within these models is recognised here and the investment in this direction should also be prioritised.

### ***Transparency and reproducibility***

The data treatment and necessary calculations are easily understandable and can be used to include further data, further countries, or further receiving ecosystems.

In the case new data is available and rate coefficients updated (improved) or any different dataset tested in the present format, the model is easily adaptable, providing that the spreadsheets are corrected accordingly.

### ***Applicability***

The method principles are defined and described in the present report. While the results can be easily obtained the applicability of the model is still constrained by data sources quality and its availability, namely emissions and leaching/export to sfw from agriculture activities – Bouwman's

model (Bouwman 2011a, 2011b), and the atmospheric deposition rates by Roy's model (Roy 2011; Roy et al. 2012).

Improvements or refinements of the underlying exports to river and loss rates can definitely improve applicability and quality of the resulting CFs.

At the present version, the model renders a wide applicability providing CFs for 143 countries and 4 emissions routes, enhanced by 214 Country-to-LME spatial combinations, and aggregation into 13 regions or continents, and a global default. CF aggregation can be performed for any desired geographical grouping.

NRs/NFs are provided at a country (143), region/continent (13) and world (1) scale.

### 3.5 Final considerations

An ecosystem-based approach can bridge between a decision-support tool, such as LCA, and a management/regulatory framework. LCA can, in fact, produce usable results and support decision-making processes further down the science-management bumpy road.

The present methodology aims at modelling the increment of nitrogen loadings in receiving compartments, such as the LMEs. The immediate value of the present approach is to allow the inclusion of marine eutrophication impact in the calculation of environmental impacts from products or services in a more qualified way than what is currently used.

Coastal systems managers, on a local, regional, or global reach, can also benefit from scientifically sound (cause-effect) predictions of the impacts of their management and operational decisions.

### 3.6 References for the Marine Eutrophication chapter

Appeltans W, Bouchet P, Boxshall GA, De Broyer C, De Voogd NJ, Gordon DP, Hoeksema BW, Horton T, Kennedy M, Mees J, Poore GCB, Read, G, Stöhr S, Walter, TC, Costello MJ (eds.). 2012. World Register of Marine Species. Retrieved from <http://www.marinespecies.org> [February 23rd, 2012].

Arrigo KR. 2005. Marine microorganisms and global nutrient cycles. *Nature* 437: 349-355.

Bisby FA, Roskov YR, Orrell TM, Nicolson D, Paglinawan LE, Bailly N, Kirk PM, Bourgoin T, Baillargeon G (eds.). 2009. Species 2000 & ITIS Catalogue of Life: 2009 Annual Checklist. Reading, UK: Species 2000. Retrieved from [www.catalogueoflife.org/annual-checklist/2009/](http://www.catalogueoflife.org/annual-checklist/2009/) [February 23rd, 2012].

Blaas M, Kerkhoven D, de Swart HE. 2001. Large-scale circulation and flushing characteristics of the North Sea under various climate forcings. *Climate Research* 18: 47–54.

Blanck H. 1984. Species dependent variation among aquatic organisms in their sensitivity to chemicals. *Ecological Bulletin* 36: 107-119.

Bouwman AF, Beusen AHW, Billen G. 2009. Human alteration of the global nitrogen and phosphorus soil balances for the period 1970–2050. *Global Biogeochemical Cycles*, 23, GB0A04, doi:10.1029/2009GB003576.

Bouwman AF, Kram T, Klein Goldewijk K (Eds.). 2006. Integrated modelling of global environmental change. An overview of IMAGE 2.4. Publication 500110002/2006, Netherlands Environmental Assessment Agency, Bilthoven.



Bouwman AF, Van Drecht G, Knoop JM, Beusen AHW, Meinardi CR. 2005. Exploring changes in river nitrogen export to the world's oceans. *Global Biogeochemical Cycles*, 19, GB1002, doi:10.1029/2004GB002314.

Bouwman AF. 2011a. Personal communication with AF Bouwman. Excel file: "nutdata2000\_out", version 1.2.3, 7 May 2007.

Bouwman AF. 2011b. Personal communication with AF Bouwman. DAT-files with leaching factors, denitrification factors and more in 0.5° by 0.5° spatial resolution. Calculated for the 1995 situation by IMAGE 2.2 as described in Bouwman et al. 2006.

Burnett LE, Stickle WB. 2001. Physiological responses to hypoxia. In NN Rabalais & RE Turner (eds.), *Coastal Hypoxia: Consequences for Living Resources and Ecosystems*. Washington DC: American Geophysical Union. *Coastal and Estuarine Studies* 58: 101-114.

Clark DR, Rees AP, Joint I. 2008. Ammonium regeneration and nitrification rates in the oligotrophic Atlantic Ocean: Implications for new production estimates. *Limnology and Oceanography* 53(1): 52-62.

Cloern JE 2001. Our evolving conceptual model of the coastal eutrophication problem. *Marine ecology Progress Series* 210: 223-53.

Conley DJ, Carstensen J, Vaquer-Sunyer R, Duarte CM. 2009. Ecosystem thresholds with hypoxia. *Hydrobiologia* 629: 21-29.

Curran M, de Baan L, de Schryver AM, van Zelm R, Hellweg S, Koellner T, Sonnemann G, Huijbregts MAJ. 2011. Toward meaningful end points of biodiversity in life cycle assessment. *Environmental Science and Technology* 45: 70-79.

de Jonge VN, Elliott M, Orive E. 2002. Causes, historical development, effects and future challenges of a common environmental problem: eutrophication. *Hydrobiologia* 475/476: 1-19.

del Giorgio PA, Cole JJ. 1998. Bacterial growth efficiency in natural aquatic ecosystems. *Annu. Rev. Ecol. Syst.* 29: 503-541.

Diaz RJ, Rosenberg R. 1995. Marine benthic hypoxia: a review of its ecological effects and the behavioural responses of benthic macrofauna. *Oceanography and Marine Biology: Annual Review* 33: 245-303.

Domine, LM, Vanni MJ, Renwick WH. 2010. New and regenerated primary production in a productive reservoir ecosystem. *Canadian Journal of Fisheries and Aquatic Sciences* 67: 278-287.

EC. 2009. Common implementation strategy for the Water Framework Directive (2000/60/EC). Guidance Document on eutrophication assessment in the context of European Water policies. European Communities. Guidance Document No. 23, 136 pp.

EEA. 2001. Eutrophication in Europe's coastal waters. Copenhagen: European Environmental Agency. Topic Report No. 7, 86 pp.

Finnveden G, Potting J. 1999. Eutrophication as an Impact Category – State of the Art and Research Needs. *The International Journal of Life Cycle Assessment* 4(6): 311-314.

Froese R, Pauly D (eds.). 2012. FishBase. World Wide Web electronic publication version (04/2012). Retrieved from [www.fishbase.org](http://www.fishbase.org) [April 24<sup>th</sup>, 2012].

Galloway JN, Cowling EB, Seitzinger SP, Socolow RH. 2002. Reactive Nitrogen: Too Much of a Good Thing? *Ambio* 31(2): 60-63.

Galloway JN, Dentener FJ, Capone DG, Boyer EW, Howarth RW, Seitzinger SP, Asner GP, Cleveland CC, Green PA, Holland EA, Karl DM, Michaels AF, Porter JH, Townsend AR, Vörösmarty CJ. 2004. Nitrogen cycles: past, present, and future. *Biogeochemistry* 70: 153-226.

Gray JS, Wu RS, Or YY. 2002. Effects of hypoxia and organic enrichment on the coastal marine environment. *Marine Ecology Progress Series* 238: 249-279.

Gray SJ. 1992. Eutrophication in the sea. In G. Colombo & Viviani R. (eds.), *Marine Eutrophication and Pollution Dynamics*. Fredensborg: Olsen & Olsen, pp. 3-16.

Gulliver JS, Wilson BN, Mohseni O, Erickson AJ, Hozalski RM. 2010. Biological Processes. In JS Gulliver, AJ Erickson, PT Weiss (eds.), *Stormwater Treatment: Assessment and Maintenance*. Minneapolis MN: University of Minnesota, St. Anthony Falls Laboratory. Retrieved from <http://stormwaterbook.safl.umn.edu/> [April 15th, 2012].

Haselmair A, Stachowitsch M, Zuschin M, Riedel B. 2010. Behaviour and mortality of benthic crustaceans in response to experimentally induced hypoxia and anoxia in situ. *Marine Ecology Progress Series* 414: 195-208.

Hasler AD. 1947. Eutrophication of lakes by domestic drainage. *Ecology* 28(4): 383-95.

Hauschild MZ (2005). Assessing environmental impacts in a life-cycle perspective. *Environmental Science & Technology* 39: 81A-88A.

Haye S, Slaveykova VI, Payet J. 2007. Terrestrial ecotoxicity and effect factors of metals in life cycle assessment (LCA). *Chemosphere* 68: 1489-1496.

Heip C. 1995. Eutrophication and Zoobenthos dynamics. *Ophelia* 41: 113-36.

Hinga KR, Heon J, Lewis NF. 1995. *Marine Eutrophication Review - Part 1: Quantifying the Effects of Nitrogen Enrichment on Phytoplankton in Coastal Ecosystems*. NOAA Coastal Ocean Program Decision Analysis Series No. 4. NOAA Coastal Ocean Office: Silver Spring MD, 36 pp.

Howarth RW, Marino R. 2006. Nitrogen as the Limiting Nutrient for Eutrophication in Coastal Marine Ecosystems: Evolving Views over Three Decades. *Limnology and Oceanography* 51(1, Pt.2 Eutrophication of Freshwater and Marine Ecosystems): 364-376.

Huijbregts MAJ. 2011. Editorial: Working on the global applicability of Life Cycle Impact Assessment. In LC-IMPACT Newsletter June 2011. Retrieved from <http://www.lc-impact.eu/en/newspage/newsletter-june-2011> [29th January, 2012].

Hutchinson GE. 1967. *A treatise on limnology. Introduction to lake biology and the limnoplankton, Volume II*. New York: John Wiley & Sons Inc., 1115 pp.

ISO 14044:2006. *Environmental management — Life cycle assessment — Requirements and guidelines*. Geneva, Switzerland: International Organisation for Standardisation.

Jansson B-O. 1980. Natural Systems of the Baltic Sea. *Ambio* 9: 128.

Kelly JR. 2008. "Nitrogen in the Environment: Chapter 10. Nitrogen Effects on Coastal Marine Ecosystems". U.S. Environmental Protection Agency Papers. Paper 50. Retrieved from <http://digitalcommons.unl.edu/usepapapers/50> [May 10th, 2012].

Kitsiou D, Karydis M. 2011. Coastal marine eutrophication assessment: A review on data analysis. *Environmental International* 37: 778-801.

Larsen HF, Hauschild M. 2007. Evaluation of Ecotoxicity Effect Indicators for Use in LCIA. *International Journal of Life Cycle Assessment* 12(1): 24-33.

Larsen HF, Olsen SI, Hauschild MZ, Laurent A. 2009. Deliverable 4.2 – Methodology for including specific biological effects and pathogen aspects into LCA. Work Package 4 – Assessment of environmental sustainability and best practice. EC Project "NEPTUNE", contract No.: 036845. [www.eu-neptune.org](http://www.eu-neptune.org).

Levin LA, Ekau W, Gooday AJ, Jorissen F, Middelburg JJ, Naqvi SWA, Neira C, Rabalais NN, Zhang J. 2009. Effects of natural and human-induced hypoxia on coastal benthos. *Biogeosciences* 6: 2063-2098.



- Mahon R, Fanning L, McConney P, Pollnac R. 2010. Governance characteristics of large marine ecosystems. *Marine Policy* 34: 919-927.
- Middleburg J, Levin LA. 2009. Coastal hypoxia and sediment bio-geochemistry. *Biogeosciences* 6: 1273–1293.
- Miller DC, Poucher SL, Coiro L. 2002. Determination of lethal dissolved oxygen levels for selected marine and estuarine fishes, crustaceans, and a bivalve. *Marine Biology* 140: 287-296.
- Nixon SW, Ammerman JW, Atkinson LP, Berounsky VM, Billen G, Boicourt WC, Boynton WR, Church TM, Ditoro DM, Elmgren R, Garber JH, Giblin AE, Jahnke RA, Owens NJP, Pilson MEQ & Seitzinger SP. 1996. The fate of nitrogen and phosphorous at the land-sea margin of the North Atlantic Ocean. *Biogeochemistry* 35: 141-180.
- Nixon SW, Fulweiler RW. 2009. Nutrient pollution, eutrophication, and the degradation of coastal marine ecosystems. In C.M. Duarte (ed.), *Global Loss of Coastal Habitats: Rates, Causes and Consequences*. Bilbao, Spain: Fundación BBVA, pp. 23-58.
- Nixon SW. 1995. Coastal marine eutrophication: A definition, social causes, and future concerns. *Ophelia* 41: 199-219.
- Nixon SW. 2009. Eutrophication and the microscope. *Hydrobiologia* 629(1): 5-19.
- NOAA. 2011. Ocean facts. Retrieved from [http://oceanservice.noaa.gov/facts/light\\_travel.html](http://oceanservice.noaa.gov/facts/light_travel.html) [August 30th, 2012].
- NOAA. 2012. LME Briefs. Large Marine Ecosystems of the World. Retrieved from <http://www.lme.noaa.gov/> [April 24th, 2012].
- OSPAR. 2008. Second Integrated Report on the Eutrophication Status of the OSPAR Maritime Area. OSPAR Commission. *Eutrophication Series 372/2008*, 107 pp.
- Payet J. 2005. Assessing Toxic Impacts on Aquatic Ecosystems in LCA. *International Journal of Life Cycle Assessment* 10(5): 373.
- Peel MC, Finlayson BL, McMahon TA. 2007. Updated world map of the Köppen-Geiger climate classification. *Hydrology and Earth System Sciences* 11: 1633-1644.
- Pennington DW, Payet J, Hauschild M. 1994. Aquatic ecotoxicological indicators in life-cycle assessment. *Environmental Toxicology and Chemistry* 23(7): 1796-1807.
- Pinet PR. 2008. *Invitation to Oceanography*. Jones & Barlett Learning, 220 pp.
- Platt T & Sathyendranath S. 1988. Oceanic Primary Production: Estimation by Remote Sensing at Local and Regional Scales. *Science* 241(4873): 1613-1620.
- Platt T, Sathyendranath S. 2007. Calculation of Primary Production from Remotely-sensed Data on Ocean Colour. In *Modelling Primary Production Series*, vol. XXIV, pp. 205-215. Retrieved from <http://www.geosafari.org/kochi/Forms/PPMOMNI.pdf> [May 1st, 2012].
- Posthuma L, Suter II GW, Traas TP (eds.). 2002. *Species Sensitivity Distributions in Ecotoxicology*. Boca Raton FL: Lewis Publishers.
- Powers SP, Peterson CH, Christian RR, Sullivan E, Powers MJ, Bishop MJ & Buzzelli CP. 2005. Effects of eutrophication on bottom habitat and prey resources of demersal fishes. *Marine Ecology Progress Series* 302: 233-243.
- Rabalais NN, Turner RE, Wiseman WJ. 2002. Gulf of Mexico hypoxia, aka “The dead zone”. *Annual Review of Ecology and Systematics* 33: 235-263.
- Redfield AC. 1934. On the proportions of organic derivations in sea water and their relation to the composition of plankton. In RJ Daniel (ed.), *James Johnson Memorial Volume*. Liverpool: University Press of Liverpool, pp. 177-192.

Redfield AC. 1958. The biological control of chemical factors in the environment. *American Scientist* 46: 205-221.

Riedel B, Zuschin M, Haselmair A, Stachowitsch M. 2008. Oxygen depletion under glass: behavioural responses of benthic macrofauna to induced anoxia in the Northern Adriatic. *Journal of Experimental Marine Biology and Ecology* 367: 17-27.

Roy P-O, Huijbregts MAJ, Deschênes L, Margni M. 2012. Spatially-differentiated atmospheric source-receptor relationships for nitrogen oxides, sulfur oxides, and ammonia emissions at the global scale for life cycle impact assessment. *Atmospheric Environment* 62: 74-81

Roy P-O. 2012. Personal communication with P-O Roy. Excel file: "country\_resolution\_SRMs (jan\_2012)", 27 April 2012.

Sala E, Knowlton N. 2006. Global marine biodiversity trends. *Annual Review of Environment and Resources* 31:93-122.

Sand-Jensen K. 2000. *Økologi og biodiversitet - overordnede mønstre for individer, bestande og økosystemer*. Copenhagen: Gad Publishers, 509 pp (in Danish).

Scavia D, Field JC, Boesch DF, Buddemeier RW, Burkett V, Cayan DR, Fogarty M, Harwell MA, Howarth RW, Mason C, Reed DJ, Royer TC, Sallenger AH, Titus JG. 2002. Climate Change Impacts on U. S. Coastal and Marine Ecosystems. *Estuaries* 25(2): 149-164.

Sherman K & Hempel G (eds.). 2009. *The UNEP Large Marine Ecosystem Report: A Perspective on Changing Conditions in LMEs of the World's Regional Seas*. UNEP Regional Seas Report and Studies No. 182. Nairobi, Kenya: UNEP, 872 p.

Sherman K, Duda AM. 1999. Large Marine Ecosystems: An Emerging Paradigm for Fishery Sustainability. *Fisheries* 24(12): 15-26.

Sherman K. 1991. The Large Marine Ecosystem Concept: Research and Management Strategy for Living Marine Resources. *Ecological Applications* 1(4): 350-360.

Sleeswijk AW, van Oers LFCM, Guinée JB, Struijs J, Huijbregts MAJ. 2008. Normalisation in Product Life Cycle Assessment: An LCA of the Global and European Economic Systems in the Year 2000. *Science of The Total Environment* 390: 227-240.

Smith VH, Tilman GD, Nekola JC. 1999. Eutrophication: impacts of excess nutrient inputs on freshwater, marine, and terrestrial ecosystems. *Environmental Pollution* 100: 179-196.

Socolow RH. 1999. Nitrogen management and the future of food: Lessons from the management of energy and carbon. *Proceedings of the National Academy of Sciences USA* 96: 6001-6008.

Spalding MD, Fox, HE, Allen GR, Davidson N, Ferdaña ZA, Finlayson M, Halpern BS, Jorge MA, Lombana A, Lourie SA, Martin KD, McManus E, Molnar J, Recchia CA, Robertson J. 2007. Marine Ecoregions of the World: A Bioregionalization of Coastal and Shelf Areas. *BioScience* 57(7): 573-583.

Steckbauer A, Duarte CM, Carstensen J, Vaquer-Sunyer R, Conley DJ. 2011. Ecosystem impacts of hypoxia: thresholds of hypoxia and pathways to recovery. *Environmental Research Letters* 6: 025003.

Steele JH. 1974. *The structure of marine ecosystems*. Cambridge: Harvard University Press, 128 pp.

Strandesen M, Birkved M, Holm PE, Hauschild MZ. 2007. Fate and distribution of metals in life cycle impact assessment. *Ecological Modelling* 203: 327-338.

Thibodeau B, de Vernal A, Mucci A. 2006. Recent eutrophication and consequent hypoxia in the bottom waters of the Lower St. Lawrence Estuary: Micropaleontological and geochemical evidence. *Marine Geology* 231: 37-50.

Turner RE, Rabalais NN. 1994. Coastal eutrophication near Mississippi River Delta. *Nature* 368: 216-619.

UN 2013. National Accounts Main Aggregates Database. Retrieved from <http://unstats.un.org/unsd/snaama/selbasicFast.asp> [August 30th, 2012].

UNEP. 2003. Eutrophication monitoring and strategy of MED POL. Athens: UNEP(DEC)/MED WG.231/14.

UNESCO. 2009. Global Open Oceans and Deep Seabed (GOODS) Biogeographical Classification. Marjo Vierros, Ian Cresswell, Elva Escobar Briones, Jake Rice & Jeff Ardron (eds). Intergovernmental Oceanographic Commission, IOC Technical Series No. 84, 96 pp.

USEPA. 2004. Species Sensitivity Distribution Generator (SSD\_Generator\_V1.xlt). CADDIS Volume 4: data Analysis. U.S. Environmental Protection Agency. Retrieved from [http://www.epa.gov/caddis/da\\_software\\_ssdmacro.html](http://www.epa.gov/caddis/da_software_ssdmacro.html) [March 23rd, 2012].

Van Drecht G, Bouwman AF, Harrison J, Knoop JM. 2009. Global nitrogen and phosphate in urban wastewater for the period 1970 to 2050. *Global Biogeochemical Cycles*, 23, GB0A03, doi:10.1029/2009GB003458.

Van Drecht G, Bouwman AF, Knoop JM, Beusen AHW, Meinardi CR. 2003. Global modeling of the fate of nitrogen from point and nonpoint sources in soils, groundwater, and surface water. *Global Biogeochemical Cycles*, 17(4), 1115, doi:10.1029/2003GB002060.

Vaquer-Sunyer R, Duarte CM. 2010. Sulphide exposure accelerates hypoxia-driven mortality. *Limnology and Oceanography* 55: 1075-1082.

Vaquer-Sunyer R, Duarte CM. 2008. Thresholds of hypoxia for marine biodiversity. *Proceedings of the National Academy of Sciences USA* 105: 15452–15457.

Vitousek PM, Hättenschwiler S, Olander L, Allison S. 2002. Nitrogen and Nature. *Ambio* 31(2): 97-101.

Vollenweider RA (1992). Coastal marine eutrophication: principles and control. In RA Vollenweider, R Marchetti & R Viviani (eds.), *Marine coastal eutrophication*. London: Elsevier, pp. 1-20.

Wassmann P. 1990. Calculating the Load of Organic Carbon to the Aphotic Zone in Eutrophicated Coastal Waters. *Marine Pollution Bulletin* 21(4): 183-187.

Wilke CR, Chang P. 1955. Correlation of diffusion coefficients in dilute solutions. *American Institute of Chemical Engineers Journal* 1: 264-270.

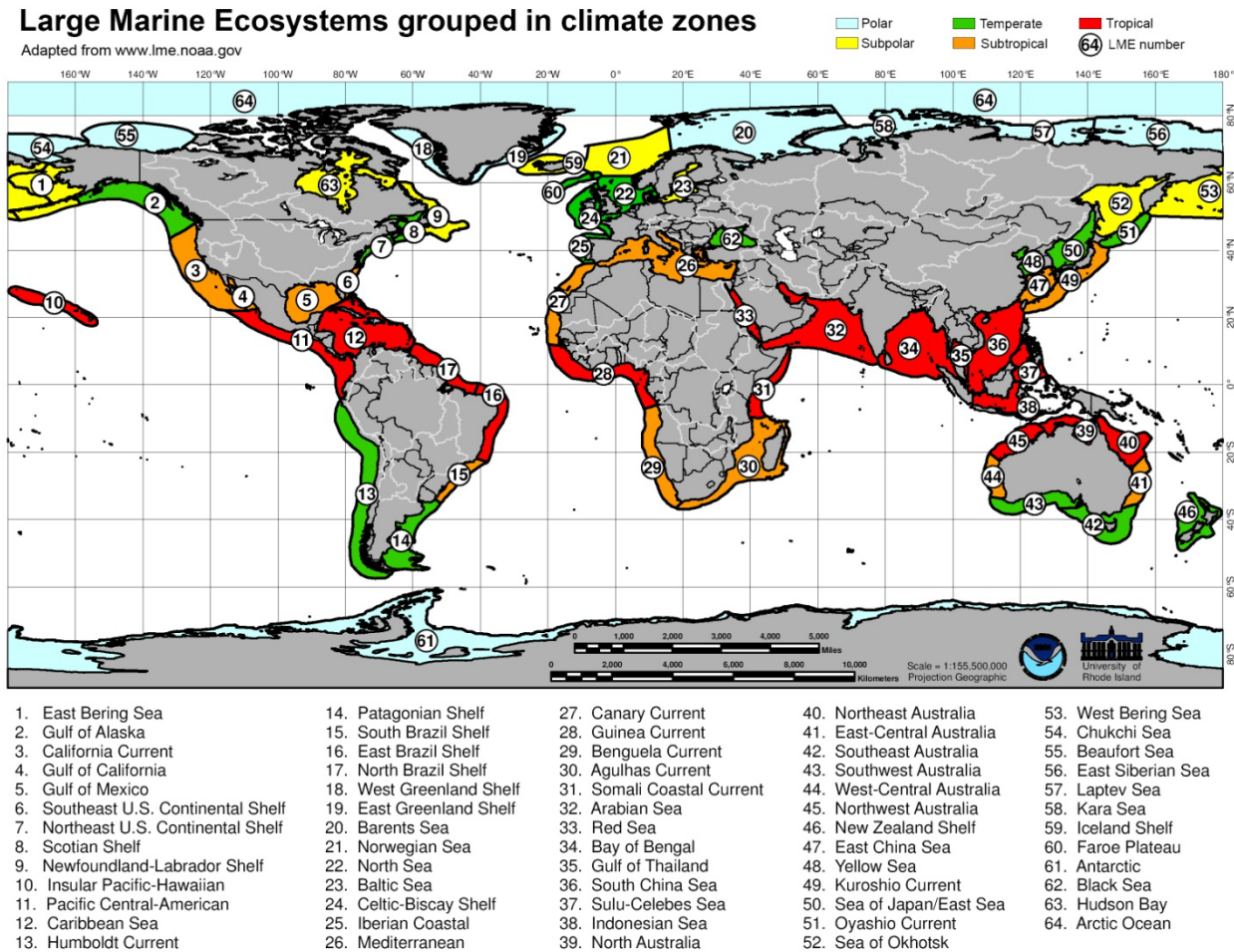
Wollheim WM, Vörösmarty CJ, Bouwman AF, Green P, Harrison J, Linder E, Peterson BJ, Seitzinger SP, Syvitski JPM. 2008. Global N removal by freshwater aquatic systems using a spatially distributed, within-basin approach, *Global Biogeochemical Cycles*, 22, GB2026, doi:10.1029/2007GB002963.

Wollheim WM, Vörösmarty CJ, Peterson BJ, Seitzinger SP, Hopkinson CS. 2006. Relationship between river size and nutrient removal, *Geophysical Research Letters*, 33, L06410, doi:10.1029/2006GL025845.

Wu RSS. 2002. Hypoxia: from molecular responses to ecosystem responses. *Marine Pollution Bulletin* 45: 35-45.

### 3.7 Appendices

#### Appendix 3-I. Large Marine Ecosystems (LMEs)



**Figure 3.6:** Geographical location of the 64 Large Marine Ecosystems (LMEs) grouped in the proposed 5 climate zones as per criteria shown in Table 3.5 (Appendix 3-II) (*adapted from [www.lme.noaa.gov](http://www.lme.noaa.gov)*).

### Appendix 3-II: Climate Zones

**Table 3.5:** Classification and grouping of Large Marine Ecosystems (LME) into Climate Zones. Calculations refer to the estimation of the mean annual sea surface temperature (maSST) for 2005, based on the regression parameters of maSST data from 1957-2005 (data source: LME briefs, from NOAA, 2012).

ID LME name	Regression coefficients		Calculation: $maSST_{2012} = b \times 2005 + a$ Estimation mean annual SST 2005	Classification Climate zone
	b	a		
64. Arctic Ocean			ice covered all year	Polar
55. Beaufort Sea	0.0034	-8.1379		Polar
61. Antarctic	0.0023	-5.7893		Polar
56. East Siberian Sea	0.0075	-16.1415		Polar
57. Laptev Sea	0.0065	-13.6953		Polar
58. Kara Sea	0.0061	-12.8746		Polar
54. Chukchi Sea	0.0118	-23.6389		Polar
63. Hudson Bay	0.0120	-23.1076		Polar
18. West Greenland Shelf	0.0086	-16.2938		Polar
19. East Greenland Shelf	0.0104	-18.9583		Polar
20. Barents Sea	-0.0008	4.8359		Polar
52. Sea of Okhotsk	0.0100	-15.4208		Subpolar
1. East Bering Sea	0.0094	-13.6712		Subpolar
53. West Bering Sea	0.0097	-14.3607		Subpolar
9. Newfoundland-Labrador Shelf	0.0157	-25.9772		Subpolar
59. Iceland Shelf	-0.0022	10.3775		Subpolar
23. Baltic Sea	0.0153	-22.3495		Subpolar
21. Norwegian Sea	0.0036	1.2815		Subpolar
51. Oyashio Current	0.0097	-12.4524		Temperate
8. Scotian Shelf	0.0235	-38.7342		Temperate
60. Faroe Plateau	-0.0030	15.5008		Temperate
2. Gulf of Alaska	0.0078	-6.0887		Temperate
22. North Sea	0.0179	-25.3213		Temperate
14. Patagonian Shelf	0.0031	4.6785		Temperate
7. Northeast U.S. Continental Shelf	0.0221	-31.7350		Temperate
24. Celtic-Biscay Shelf	0.0083	-3.5225		Temperate
50. Sea of Japan/East Sea	0.0167	-19.9861		Temperate
62. Black Sea	-0.0017	18.2366		Temperate
42. Southeast Australia	0.0108	-6.8315		Temperate
46. New Zealand Shelf	0.0023	10.8093		Temperate
48. Yellow Sea	0.0197	-24.1103		Temperate
13. Humboldt Current	0.0083	-0.1418		Temperate
25. Iberian Coastal	0.0162	-15.5848		Temperate
43. Southwest Australia	0.0086	0.0699		Temperate
3. California Current	0.0065	4.3347		Subtropical
26. Mediterranean	0.0088	2.2496		Subtropical
29. Benguela Current	0.0054	9.9577		Subtropical
27. Canary Current	0.0098	2.4479		Subtropical
47. East China Sea	0.0317	-41.3278		Subtropical
44. West-Central Australia	0.0167	-11.1084		Subtropical
15. South Brazil Shelf	0.0228	-22.8069		Subtropical
49. Kuroshio Current	0.0132	-3.4566		Subtropical
41. East-Central Australia	0.0115	-0.0330		Subtropical
4. Gulf of California	0.0254	-26.4000		Subtropical
6. Southeast U.S. Continental Shelf	-0.0031	31.0589		Subtropical
30. Agulhas Current	0.0139	-2.4145		Subtropical
5. Gulf of Mexico	0.0038	18.4183		Subtropical
10. Insular Pacific-Hawaiian	0.0006	23.6974		Tropical
40. Northeast Australia	0.0095	7.7313		Tropical
16. East Brazil Shelf	0.0116	3.9558		Tropical
31. Somali Coastal Current	0.0094	8.4143		Tropical
11. Pacific Central-American	0.0060	15.4948		Tropical
28. Guinea Current	0.0118	3.8046		Tropical
32. Arabian Sea	0.0085	10.5733		Tropical
12. Caribbean Sea	0.0005	26.7566		Tropical
45. Northwest Australia	0.0086	10.5848		Tropical
17. North Brazil Shelf	0.0044	19.0068		Tropical
36. South China Sea	0.0163	-4.5643		Tropical
33. Red Sea	0.0060	16.1768		Tropical
39. North Australia	0.0085	11.1456		Tropical
34. Bay of Bengal	0.0102	8.3154		Tropical
38. Indonesian Sea	0.0109	6.9714		Tropical
35. Gulf of Thailand	0.0082	12.3672		Tropical
37. Sulu-Celebes Sea	0.0126	3.6460		Tropical



### Appendix 3-III. Nitrogen losses in the marine compartment

**Table 3.6:** Residence times (from sources or by defined archetype) of the receiving Large Marine ecosystems (LME). *Reference sources listed in the following pages.*

LME # name	Residence time		Reference source
	archetype	used [yr]	
1. East Bering Sea	2	2.00	
2. Gulf of Alaska	1	0.25	
3. California Current	1	0.25	
4. Gulf of California	1-2	1.50	Lopez & Garcia (2003)
5. Gulf of Mexico	4	90.00	Turner & Rabalais (2009); USGS (2012); Rivas et al. (2005)
6. Southeast U.S. Continental Shelf	1	0.25	Alegria et al. (2000)
7. Northeast U.S. Continental Shelf	1	0.25	
8. Scotian Shelf	1	0.88	Smith et al. (2003)
9. Newfoundland-Labrador Shelf	1	0.25	
10. Insular Pacific-Hawaiian	1	0.25	
11. Pacific Central-American	1	0.25	
12. Caribbean Sea	1	0.21	Molinari et al. (1980)
13. Humboldt Current	1	0.03	Hall et al. (1996)
14. Patagonian Shelf	1	0.25	
15. South Brazil Shelf	1	0.25	
16. East Brazil Shelf	1	0.25	Attisano et al. (2008)
17. North Brazil Shelf		0.25	Limeburner et al. (1995)
18. West Greenland Shelf	1	0.25	
19. East Greenland Shelf	1	0.25	
20. Barents Sea	2	2.00	
21. Norwegian Sea	2	2.00	
22. North Sea	2	2.00	Blaas et al. (2001)
23. Baltic Sea		25.00	Jansson B-O (1980); Matthäus & Schinke (1999)
24. Celtic-Biscay Shelf	2	2.00	
25. Iberian Coastal	1	0.25	
26. Mediterranean	4	90.00	Pinet PR (2008)
27. Canary Current	1	0.25	
28. Guinea Current	2	3.10	Hall et al. (1996)
29. Benguela Current	1	0.25	
30. Agulhas Current	2	2.00	
31. Somali Coastal Current	1	0.25	INaqvi (2012)
32. Arabian Sea	2-3	6.50	Sarma (2002)
33. Red Sea		40.00	Smeed (2010); Grasshoff (1969); Tomczak & Godfrey (2003)
34. Bay of Bengal	2-3	12.00	Sarma (2002)
35. Gulf of Thailand	1-2	0.04	Dulaiova et al. (2006)
36. South China Sea	3	25.00	
37. Sulu-Celebes Sea	3	25.00	Tessler (2012); Tessler et al. (2011).
38. Indonesian Sea	1-2	0.75	Field & Gordon (1992)
39. North Australia	1	0.25	
40. Northeast Australia	1	0.25	Choukroun et al. (2010)
41. East-Central Australia	1	0.25	
42. Southeast Australia	1	0.25	
43. Southwest Australia	1	0.25	
44. West-Central Australia	1	0.25	
45. Northwest Australia	1	0.25	
46. New Zealand Shelf	1	0.25	
47. East China Sea		1.90	Tsunogai et al. (1997); Tomczak & Godfrey (2003); Hall et al. (1996)
48. Yellow Sea		2.00	Tsunogai et al. (1997); Tomczak & Godfrey (2003)
49. Kuroshio Current		2.30	Matsuno et al. (2009)
50. Sea of Japan/East Sea	3	25.00	
51. Oyashio Current	1	0.25	
52. Sea of Okhotsk	2	2.00	Yamamoto et al. (2001)
53. West Bering Sea	1	0.25	
54. Chukchi Sea		3.50	Schlosser et al. (1994)
55. Beaufort Sea		3.50	Schlosser et al. (1994)
56. East Siberian Sea		3.50	Schlosser et al. (1994)
57. Laptev Sea		3.50	Schlosser et al. (1994)
58. Kara Sea		3.50	Schlosser et al. (1994)
59. Iceland Shelf	1	0.25	
60. Faroe Plateau	1	0.25	Gaard (2000)
61. Antarctic	2-3	6.00	Jacobs et al. (1985)
62. Black Sea	4	90.00	Murray et al. (2007)
63. Hudson Bay	2-3	6.60	Ingram & Prinsenberg (1998)
64. Arctic Ocean	2-3	11.00	Jahn et al. (2010)

Continental shelves' bathymetry consulted from Liu et al. (2012).

**References used to compile the LMEs' residence time:**

- Alegria HA, D'Autel JP & Shaw TJ (2000). Offshore Transport of Pesticides in the South Atlantic Bight: Preliminary Estimate of Export Budgets. *Marine Pollution Bulletin* 40(12): 1178-1185.
- Attisano KK, Niencheski LFH, Milani ICB, Machado CS, Milani MR, Zarzur S & Andrade CFF (2008). Evidences of continental groundwater inputs to the shelf zone in Albardão, RS, Brazil. *Brazilian Journal of Oceanography* 56(3): 189-200.
- Blaas M, Kerkhoven D & de Swart HE (2001). Large-scale circulation and flushing characteristics of the North Sea under various climate forcings. *Climate Research* 18: 47–54.
- Choukroun S, Ridd PV, Brinkman R & McKinna LIW (2010). On the surface circulation in the western Coral Sea and residence times in the Great Barrier Reef. *Journal of Geophysical Research* 115, C06013.
- Dulaiova H, Burnett WC, Wattayakorn G & Sojisuoporn P (2006). Are groundwater inputs into river-dominated areas important? The Chao Phraya River – Gulf of Thailand. *Limnology and Oceanography* 51(5): 2232–2247.
- Ffield A & Gordon AL (1992). Vertical mixing in the Indonesian Thermocline. *Journal of Physical Oceanography* 22: 184–195.
- Gaard E (2000). Seasonal abundance and development of *Calanus finmarchicus* in relation to phytoplankton and hydrography on the Faroe Shelf. *ICES Journal of Marine Science* 57: 1605–16711.
- Gordon AL, Tessler ZD & Villanoy C (2011). Dual overflows into the deep Sulu Sea. *Geophysical Research Letters* 38, L18606.
- Grasshoff K (1969). Chemical observations in the Red Sea and the inner Gulf of Aden during the International Indian Ocean Expedition 1964/65. Supplement to: Grasshoff K (1969): *Zur Chemie des Roten Meeres und des Inneren Golfs von Aden nach Beobachtungen von F.S. "Meteor" während der Indischen Ozean Expedition 1964/65. Meteor Forschungsergebnisse, Deutsche Forschungsgemeinschaft, Reihe A Allgemeines, Physik und Chemie des Meeres, Gebrüder Bornträger, Berlin, Stuttgart, A6: 1-76.*
- Hall J, Smith SV & Boudreau PR (eds.) (1996). "Report on the International Workshop on Continental Shelf Fluxes of Carbon, Nitrogen and Phosphorus". LOICZ/R&S/96-9. LOICZ, Texel, The Netherlands.
- Ingram RG & Prinsenbergs S (1998). Chapter 29. Coastal oceanography of Hudson Bay and surrounding eastern Canadian arctic waters coastal segment. In Allan R Robinson & Kenneth H Brink (eds.), "The Sea - Volume 11". John Wiley & Sons, Inc.
- Jacobs SS, Fairbanks RG & Horibe YG (1985). Origin and evolution of water masses near the Antarctic continental margin: Evidence from H218O/H216O ratios in seawater. In S. Jacobs (ed), "Oceanology of the Antarctic Continental Shelf", AGU, Washington, D.C., Antarctic Research Series 43: 59–85.
- Jahn A, Tremblay LB, Newton R, Holland MM, Mysak LA & Dmitrenko IA (2010). A tracer study of the Arctic Ocean's liquid freshwater export variability. *Journal of Geophysical Research* 115, C07015.
- Jansson B-O. 1980. Natural Systems of the Baltic Sea. *Ambio* 9: 128.
- Limeburner R, Beardsley RC, Soares ID, Lentz SJ & Candela J (1995). Lagrangian flow observations of the Amazon River discharge into the North Atlantic. *Journal of Geophysical Research* 100(C2): 2401–2415.
- Liu K-K, Dittert N, Lei KR, Kremer HH & Maddison L (2012). Web-based Resources for Continental Margins Biogeochemical Research and Education. Retrieved from [http://cmtt.tori.org.tw/data/App\\_map/maplist.htm](http://cmtt.tori.org.tw/data/App_map/maplist.htm) on 12/09/2012.
- Lopez M & Garcia J (2003). Moored observations in the northern Gulf of California: A strong bottom current. *Journal of Geophysical Research* 108(C2): 3048.
- Matthäus W & Schinke H (1999). The influence of river runoff on deep water conditions of the Baltic Sea. *Hydrobiologia* 393: 1–10.
- Matsuno T, Lee J-S & Yanao S (2009). Influence of the Kuroshio on the water properties in the shelf. *Ocean Science Discussions* 6: 741–764.



- Molinari RL, Atwood DK, Duckett C, Spillane M & Brooks I (1980). Surface currents in the Caribbean Sea as deduced from satellite tracked drifting buoys. *Proceedings of the 32nd Annual Gulf and Caribbean Fisheries Institute* 106-113.
- Murray JW, Stewart K, Kassakian S, Krynytzky M & DiJulio D (2007). Oxic, suboxic, and anoxic conditions in the Black Sea. In V Yanko-Hombach, AS Gilbert, N Panin & PM Dolukhanov (eds), "The Black Sea Flood Question: Changes in Coastline, Climate and Human Settlement". Springer, pp. 1-22.
- Naqvi W (2012). Intensification of seasonal oxygen-deficient zone over the western Indian shelf. Retrieved from <http://www.unep.org/stap/Portals/61/stap/Naqvi.pdf> on 12/09/2012.
- Pinet PR (2008). "Invitation to Oceanography". Jones & Barlett Learning, 220 pp.
- Rivas D, Badan A & Ochoa J (2005): The Ventilation of the Deep Gulf of Mexico. *Journal of Physical Oceanography* 35: 1763–1781.
- Sarma VVSS (2002). An evaluation of physical and biogeochemical processes regulating perennial suboxic conditions in the water column of the Arabian Sea. *Global Biogeochemical Cycles* 16(4): 1082.
- Schlosser P, Bauch D, Bonisch G & Fairbanks RF (1994). Arctic river-runoff: mean residence time on the shelves and in the halocline. *Deep-Sea Research I* 41(7): 1053–1068.
- Smeed D (2010). The circulation of the Red Sea. *Red Sea Research Workshop: Past & Present*. Retrieved from [http://krse.kaust.edu.sa/spring-2010/downloads/David%20Smeed\\_Southampton.pdf](http://krse.kaust.edu.sa/spring-2010/downloads/David%20Smeed_Southampton.pdf) on 12/09/2012.
- Smith PC, Flagg CN, Limeburner R, Fuentes-Yaco C, Hannah C, Beardsley RC & Irish JD (2003). Scotian Shelf crossovers during winter/spring 1999. *Journal of Geophysical Research* 108: 8013.
- Tessler ZD (2012). "Still overflow processes in the Philippine Archipelago". PhD Thesis. Columbia University. Retrieved from <http://academiccommons.columbia.edu/catalog/ac%3A143841> on 12/09/2012.
- Tomczak M & Godfrey JS (2003). "Regional Oceanography: an Introduction". 2<sup>nd</sup> edition. Pergamon.
- Tsunogai S, Watanabe S, Nakamura J, Ono T & Sato T (1997). A Preliminary Study of Carbon System in the East China Sea. *Journal of Oceanography* 53: 9-17.
- Turner E & Rabalais N (2009). 2009 Forecast of the Summer Hypoxic Zone Size, Northern Gulf of Mexico. Retrieved from [http://www.gulfhypoxia.net/research/Shelfwide%20Cruises/2009/Files/2009\\_Hypoxia\\_Forecast.pdf](http://www.gulfhypoxia.net/research/Shelfwide%20Cruises/2009/Files/2009_Hypoxia_Forecast.pdf) on 12/09/2012.
- USGS (2012). Streamflow and Nutrient Delivery to the Gulf of Mexico for October 2011 to May 2012 (Preliminary). Retrieved from [http://toxics.usgs.gov/hypoxia/mississippi/oct\\_jun/index.html](http://toxics.usgs.gov/hypoxia/mississippi/oct_jun/index.html) on 12/09/2012.
- Yamamoto M, Tanaka N & Tsunogai S (2001). Okhotsk Sea intermediate water formation deduced from oxygen isotope systematics. *Journal of Geophysical Research* 106(C12): 31075–31084.

**Table 3.7:** Estimation of the Nitrogen loss rate coefficient ( $\lambda$ ) in marine coastal waters.

LME		Loss rate	Adv	Denitr	Sedim	Adv	Denitr	Sedim
#. name	unit:	d <sup>-1</sup>	d	d <sup>-1</sup>	d <sup>-1</sup>	yr	yr <sup>-1</sup>	yr <sup>-1</sup>
1. East Bering Sea	1	2.49E-03	7.31E+02	9.77E-04	1.40E-04	2.00	0.36	0.05
2. Gulf of Alaska	2	1.21E-02	9.13E+01	9.77E-04	1.40E-04	0.25	0.36	0.05
3. California Current	3	1.21E-02	9.13E+01	9.77E-04	1.40E-04	0.25	0.36	0.05
4. Gulf of California	4	2.94E-03	5.48E+02	9.77E-04	1.40E-04	1.50	0.36	0.05
5. Gulf of Mexico	5	1.15E-03	3.29E+04	9.77E-04	1.40E-04	90.00	0.36	0.05
6. Southeast U.S. Continental Shelf	6	1.21E-02	9.13E+01	9.77E-04	1.40E-04	0.25	0.36	0.05
7. Northeast U.S. Continental Shelf	7	1.21E-02	9.13E+01	9.77E-04	1.40E-04	0.25	0.36	0.05
8. Scotian Shelf	8	4.25E-03	3.20E+02	9.77E-04	1.40E-04	0.88	0.36	0.05
9. Newfoundland-Labrador Shelf	9	1.21E-02	9.13E+01	9.77E-04	1.40E-04	0.25	0.36	0.05
10. Insular Pacific-Hawaiian	10	1.21E-02	9.13E+01	9.77E-04	1.40E-04	0.25	0.36	0.05
11. Pacific Central-American	11	1.21E-02	9.13E+01	9.77E-04	1.40E-04	0.25	0.36	0.05
12. Caribbean Sea	12	1.44E-02	7.51E+01	9.77E-04	1.40E-04	0.21	0.36	0.05
13. Humboldt Current	13	9.20E-02	1.10E+01	9.77E-04	1.40E-04	0.03	0.36	0.05
14. Patagonian Shelf	14	1.21E-02	9.13E+01	9.77E-04	1.40E-04	0.25	0.36	0.05
15. South Brazil Shelf	15	1.21E-02	9.13E+01	9.77E-04	1.40E-04	0.25	0.36	0.05
16. East Brazil Shelf	16	1.21E-02	9.13E+01	9.77E-04	1.40E-04	0.25	0.36	0.05
17. North Brazil Shelf	17	1.21E-02	9.13E+01	9.77E-04	1.40E-04	0.25	0.36	0.05
18. West Greenland Shelf	18	1.21E-02	9.13E+01	9.77E-04	1.40E-04	0.25	0.36	0.05
19. East Greenland Shelf	19	1.21E-02	9.13E+01	9.77E-04	1.40E-04	0.25	0.36	0.05
20. Barents Sea	20	2.49E-03	7.31E+02	9.77E-04	1.40E-04	2.00	0.36	0.05
21. Norwegian Sea	21	2.49E-03	7.31E+02	9.77E-04	1.40E-04	2.00	0.36	0.05
22. North Sea	22	2.49E-03	7.31E+02	9.77E-04	1.40E-04	2.00	0.36	0.05
23. Baltic Sea	23	1.23E-03	9.13E+03	9.77E-04	1.40E-04	25.00	0.36	0.05
24. Celtic-Biscay Shelf	24	2.49E-03	7.31E+02	9.77E-04	1.40E-04	2.00	0.36	0.05
25. Iberian Coastal	25	1.21E-02	9.13E+01	9.77E-04	1.40E-04	0.25	0.36	0.05
26. Mediterranean	26	1.15E-03	3.29E+04	9.77E-04	1.40E-04	90.00	0.36	0.05
27. Canary Current	27	1.21E-02	9.13E+01	9.77E-04	1.40E-04	0.25	0.36	0.05
28. Guinea Current	28	2.00E-03	1.13E+03	9.77E-04	1.40E-04	3.10	0.36	0.05
29. Benguela Current	29	1.21E-02	9.13E+01	9.77E-04	1.40E-04	0.25	0.36	0.05
30. Agulhas Current	30	2.49E-03	7.31E+02	9.77E-04	1.40E-04	2.00	0.36	0.05
31. Somali Coastal Current	31	1.21E-02	9.13E+01	9.77E-04	1.40E-04	0.25	0.36	0.05
32. Arabian Sea	32	1.54E-03	2.37E+03	9.77E-04	1.40E-04	6.50	0.36	0.05
33. Red Sea	33	1.19E-03	1.46E+04	9.77E-04	1.40E-04	40.00	0.36	0.05
34. Bay of Bengal	34	1.35E-03	4.38E+03	9.77E-04	1.40E-04	12.00	0.36	0.05

LME		Loss rate	Adv	Denitr	Sedim	Adv	Denitr	Sedim
#. name	unit:	d <sup>-1</sup>	d	d <sup>-1</sup>	d <sup>-1</sup>	yr	yr <sup>-1</sup>	yr <sup>-1</sup>
35. Gulf of Thailand	35	7.25E-02	1.40E+01	9.77E-04	1.40E-04	0.04	0.36	0.05
36. South China Sea	36	1.23E-03	9.13E+03	9.77E-04	1.40E-04	25.00	0.36	0.05
37. Sulu-Celebes Sea	37	1.23E-03	9.13E+03	9.77E-04	1.40E-04	25.00	0.36	0.05
38. Indonesian Sea	38	4.77E-03	2.74E+02	9.77E-04	1.40E-04	0.75	0.36	0.05
39. North Australia	39	1.21E-02	9.13E+01	9.77E-04	1.40E-04	0.25	0.36	0.05
40. Northeast Australia	40	1.21E-02	9.13E+01	9.77E-04	1.40E-04	0.25	0.36	0.05
41. East-Central Australia	41	1.21E-02	9.13E+01	9.77E-04	1.40E-04	0.25	0.36	0.05
42. Southeast Australia	42	1.21E-02	9.13E+01	9.77E-04	1.40E-04	0.25	0.36	0.05
43. Southwest Australia	43	1.21E-02	9.13E+01	9.77E-04	1.40E-04	0.25	0.36	0.05
44. West-Central Australia	44	1.21E-02	9.13E+01	9.77E-04	1.40E-04	0.25	0.36	0.05
45. Northwest Australia	45	1.21E-02	9.13E+01	9.77E-04	1.40E-04	0.25	0.36	0.05
46. New Zealand Shelf	46	1.21E-02	9.13E+01	9.77E-04	1.40E-04	0.25	0.36	0.05
47. East China Sea	47	2.56E-03	6.94E+02	9.77E-04	1.40E-04	1.90	0.36	0.05
48. Yellow Sea	48	2.49E-03	7.31E+02	9.77E-04	1.40E-04	2.00	0.36	0.05
49. Kuroshio Current	49	2.31E-03	8.40E+02	9.77E-04	1.40E-04	2.30	0.36	0.05
50. Sea of Japan/East Sea	50	1.23E-03	9.13E+03	9.77E-04	1.40E-04	25.00	0.36	0.05
51. Oyashio Current	51	1.21E-02	9.13E+01	9.77E-04	1.40E-04	0.25	0.36	0.05
52. Sea of Okhotsk	52	2.49E-03	7.31E+02	9.77E-04	1.40E-04	2.00	0.36	0.05
53. West Bering Sea	53	1.21E-02	9.13E+01	9.77E-04	1.40E-04	0.25	0.36	0.05
54. Chukchi Sea	54	1.90E-03	1.28E+03	9.77E-04	1.40E-04	3.50	0.36	0.05
55. Beaufort Sea	55	1.90E-03	1.28E+03	9.77E-04	1.40E-04	3.50	0.36	0.05
56. East Siberian Sea	56	1.90E-03	1.28E+03	9.77E-04	1.40E-04	3.50	0.36	0.05
57. Laptev Sea	57	1.90E-03	1.28E+03	9.77E-04	1.40E-04	3.50	0.36	0.05
58. Kara Sea	58	1.90E-03	1.28E+03	9.77E-04	1.40E-04	3.50	0.36	0.05
59. Iceland Shelf	59	1.21E-02	9.13E+01	9.77E-04	1.40E-04	0.25	0.36	0.05
60. Faroe Plateau	60	1.21E-02	9.13E+01	9.77E-04	1.40E-04	0.25	0.36	0.05
61. Antarctic	61	1.57E-03	2.19E+03	9.77E-04	1.40E-04	6.00	0.36	0.05
62. Black Sea	62	1.15E-03	3.29E+04	9.77E-04	1.40E-04	90.00	0.36	0.05
63. Hudson Bay	63	1.53E-03	2.41E+03	9.77E-04	1.40E-04	6.60	0.36	0.05
64. Arctic Ocean	64	1.37E-03	4.02E+03	9.77E-04	1.40E-04	11.00	0.36	0.05

**Appendix 3-IV: Nitrogen conversion in the photic zone**

**Table 3.8:** Calculation of the Nitrogen Incorporation Efficiency (NIE) coefficient.

LME #_name	LME Area	PP	DIN	EmpN <sub>input</sub> /∞LME	EmpN <sub>input</sub>	TheorN <sub>input</sub>	NIE
	unit: km <sup>2</sup>	gC·m <sup>-2</sup> ·yr <sup>-1</sup>	molDIN·m <sup>-2</sup> ·yr <sup>-1</sup>	gN·m <sup>-2</sup> ·yr <sup>-1</sup>	gN·yr <sup>-1</sup>	gN·yr <sup>-1</sup> (gC·m <sup>-2</sup> ·yr <sup>-1</sup> )*(gN/gC)*m <sup>2</sup>	[-] EmpN/ThN
			<i>logPP = 0.442·logDIN + 2.332</i>				
1. East Bering Sea	1,193,601	285.43	1.903	66.63	7.95E+13	6.00E+13	1.326
2. Gulf of Alaska	1,491,252	330.69	2.655	92.96	1.39E+14	8.68E+13	1.597
3. California Current	2,224,665	223.75	1.097	38.41	8.54E+13	8.76E+13	0.975
4. Gulf of California	216,344	437.64	5.004	175.24	3.79E+13	1.67E+13	2.275
5. Gulf of Mexico	42,846	208.05	0.930	32.58	1.40E+12	1.57E+12	0.890
6. Southeast U.S. Continental Shelf	303,029	263.17	1.583	55.45	1.68E+13	1.40E+13	1.197
7. Northeast U.S. Continental Shelf	308,554	560.64	8.764	306.90	9.47E+13	3.05E+13	3.110
8. Scotian Shelf	412,676	509.18	7.049	246.83	1.02E+14	3.70E+13	2.754
9. Newfoundland-Labrador Shelf	674,862	295.29	2.055	71.95	4.86E+13	3.51E+13	1.384
10. Insular Pacific-Hawaiian	975,493	84.68	0.122	4.26	4.16E+12	1.45E+13	0.286
11. Pacific Central-American	1,996,659	243.82	1.332	46.65	9.31E+13	8.57E+13	1.087
12. Caribbean Sea	3,305,077	174.47	0.625	21.88	7.23E+13	1.02E+14	0.712
13. Humboldt Current	2,619,386	319.74	2.460	86.14	2.26E+14	1.47E+14	1.531
14. Patagonian Shelf	1,173,332	509.18	7.049	246.83	2.90E+14	1.05E+14	2.754
15. South Brazil Shelf	566,397	282.88	1.865	65.29	3.70E+13	2.82E+13	1.311
16. East Brazil Shelf	1,073,210	130.31	0.323	11.30	1.21E+13	2.46E+13	0.493
17. North Brazil Shelf	1,034,575	442.02	5.118	179.23	1.85E+14	8.05E+13	2.304
18. West Greenland Shelf	359,422	151.84	0.456	15.98	5.74E+12	9.61E+12	0.598
19. East Greenland Shelf	1,176,522	174.11	0.622	21.78	2.56E+13	3.61E+13	0.711
20. Barents Sea	2,023,335	151.11	0.451	15.80	3.20E+13	5.38E+13	0.594
21. Norwegian Sea	1,109,613	179.22	0.664	23.25	2.58E+13	3.50E+13	0.737
22. North Sea	690,041	406.98	4.246	148.68	1.03E+14	4.94E+13	2.075
23. Baltic Sea	396,838	697.15	14.350	502.48	1.99E+14	4.87E+13	4.095
24. Celtic-Biscay Shelf	766,550	348.94	2.998	104.98	8.05E+13	4.71E+13	1.709
25. Iberian Coastal	300,915	276.67	1.773	62.10	1.87E+13	1.47E+13	1.275
26. Mediterranean	2,528,398	157.68	0.497	17.40	4.40E+13	7.02E+13	0.627
27. Canary Current	1,120,439	436.54	4.976	174.25	1.95E+14	8.61E+13	2.268
28. Guinea Current	1,958,802	357.70	3.171	111.03	2.17E+14	1.23E+14	1.763
29. Benguela Current	1,470,134	506.26	6.958	243.64	3.58E+14	1.31E+14	2.734
30. Agulhas Current	2,615,294	220.83	1.065	37.29	9.75E+13	1.02E+14	0.959
31. Somali Coastal Current	844,524	249.30	1.401	49.06	4.14E+13	3.71E+13	1.118
32. Arabian Sea	3,950,421	390.19	3.860	135.16	5.34E+14	2.71E+14	1.968
33. Red Sea	480,385	298.21	2.101	73.57	3.53E+13	2.52E+13	1.402
34. Bay of Bengal	3,657,502	264.99	1.608	56.32	2.06E+14	1.71E+14	1.207
35. Gulf of Thailand	391,665	284.70	1.892	66.25	2.59E+13	1.96E+13	1.322
36. South China Sea	5,662,985	174.11	0.622	21.78	1.23E+14	1.74E+14	0.711
37. Sulu-Celebes Sea	1,015,737	209.15	0.942	32.97	3.35E+13	3.74E+13	0.896
38. Indonesian Sea	2,289,597	263.53	1.588	55.62	1.27E+14	1.06E+14	1.199
39. North Australia	772,214	328.50	2.615	91.57	7.07E+13	4.47E+13	1.584
40. Northeast Australia	1,299,112	130.67	0.325	11.38	1.48E+13	2.99E+13	0.495
41. East-Central Australia	660,679	157.32	0.494	17.31	1.14E+13	1.83E+13	0.625
42. Southeast Australia	1,199,787	186.88	0.730	25.56	3.07E+13	3.95E+13	0.777
43. Southwest Australia	1,046,368	180.68	0.676	23.68	2.48E+13	3.33E+13	0.745
44. West-Central Australia	543,577	173.74	0.619	21.67	1.18E+13	1.66E+13	0.709
45. Northwest Australia	911,812	185.79	0.720	25.22	2.30E+13	2.98E+13	0.771
46. New Zealand Shelf	980,420	208.05	0.930	32.58	3.19E+13	3.59E+13	0.890
47. East China Sea	1,008,066	325.22	2.556	89.52	9.02E+13	5.77E+13	1.564
48. Yellow Sea	438,619	588.75	9.790	342.82	1.50E+14	4.55E+13	3.308
49. Kuroshio Current	1,333,074	154.03	0.471	16.50	2.20E+13	3.61E+13	0.609
50. Sea of Japan/East Sea	1,054,305	220.46	1.061	37.15	3.92E+13	4.09E+13	0.957
51. Oyashio Current	663,609	261.34	1.559	54.58	3.62E+13	3.05E+13	1.186
52. Sea of Okhotsk	1,627,284	297.48	2.089	73.16	1.19E+14	8.52E+13	1.397
53. West Bering Sea	2,182,768	213.89	0.991	34.69	7.57E+13	8.22E+13	0.921
54. Chukchi Sea	783,245	90.89	0.143	5.00	3.92E+12	1.25E+13	0.313
55. Beaufort Sea	664,752	118.99	0.263	9.20	6.12E+12	1.39E+13	0.439
56. East Siberian Sea	1,024,100	54.39	0.045	1.57	1.60E+12	9.80E+12	0.164
57. Laptev Sea	539,035	156.59	0.489	17.13	9.23E+12	1.49E+13	0.621
58. Kara Sea	970,089	126.66	0.303	10.60	1.03E+13	2.16E+13	0.475
59. Iceland Shelf	521,237	201.12	0.862	30.18	1.57E+13	1.85E+13	0.852
60. Faroe Plateau	151,005	154.03	0.471	16.50	2.49E+12	4.09E+12	0.609
61. Antarctic	3,486,169	99.65	0.176	6.16	2.15E+13	6.11E+13	0.351
62. Black Sea	461,398	376.32	3.556	124.54	5.75E+13	3.06E+13	1.880
63. Hudson Bay	1,247,246	152.57	0.461	16.15	2.01E+13	3.35E+13	0.601
64. Arctic Ocean	3,522,239	8.40	0.001	0.02	8.05E+10	5.21E+12	0.015

### Appendix 3-V: Testing normality of species sensitivity data: goodness-of-fit test

The goodness-of-fit tests focus on testing the hypothesis ( $H_0$ ) of a given sample (sensitivity data in the present case) being part of a population with a distribution function  $f(x)$ . Common statistical goodness-of-fit tests (or tests for distributional adequacy) include the chi-square ( $\chi^2$ ) tests (such as Pearson's chi-square test), EDF-based tests (such as the Kolmogorov–Smirnov (K-S) test, and the Anderson-Darling (A-D) test), and regression and correlation tests (such as the Shapiro-Wilk test).

The classical option would be the  $\chi^2$ -tests, but the limited amount of data for certain concentration-classes hinders its application. Another alternative is the use of the empirical distribution function (EDF) statistics, which are based on the sample distribution function  $f_n(x)$  with the comparison of  $f(x)$  (Stephens 1979), meaning that if  $f_n(x)$  is shown as part of  $f(x)$  and that this latter is normally (or log-normally) distributed, then  $f_n(x)$  is also normally (or log-normally) distributed (as required to proceed with SSD). Additionally, EDF tests were shown more powerful than other tests (including the  $\chi^2$ -test) (Stephens 1976), and the Anderson-Darling (A-D) test is one of the most powerful of the EDF tests (Stephens 1974). The A-D test (Anderson & Darling 1952) is a more sensitive modification of the K-S test, putting more weight to the tails and calculating critical values (Stephens 1974).

The A-D test aims at reducing errors in the stochastic progress using a “test statistic of the sum of squares of the differences between the empirical and theoretical distribution functions with a weight function that emphasizes discrepancies in both tails” (Shin 2012, 105). This method concludes on the goodness-of-fit by comparing the ideal probability density function (PDF) (population's) and the empirical density function (EDF) (data's), and it is defined and calculated as shown in Box 3.1.

#### Box 3.1. Anderson-Darling goodness-of-fit statistical test

Test distribution function (PDF of a standard normal distribution, with mean  $\mu$  and standard deviation  $\sigma$ ):

$$F(x) = \frac{1}{\sigma\sqrt{2\pi}} \cdot e^{-\left(\frac{(x-\mu)^2}{2\sigma^2}\right)}$$

$H_0$ : The lognormal sample data are normally distributed, *i.e.* no significant departure from normality is found on the distribution of sensitivity data (logEC<sub>50</sub> values).

$H_a$ : The lognormal sample data are not normally distributed.

The equation for the test statistic is:

$$A^2 = -n - 2 \sum_{i=1}^n \left[ \left( \frac{1-0.5}{n} \right) \cdot \ln(z_i) + \left( 1 - \left( \frac{1-0.5}{n} \right) \right) \cdot \ln(1 - z_i) \right]$$

Where:

With:

$$z_i = \Phi\left(\frac{(x_i - \bar{x})}{s}\right) \quad \bar{x} = \frac{1}{n} \cdot \sum_{i=1}^n x_i \quad \text{and} \quad s = \sqrt{\frac{1}{n-1} \cdot \sum_{i=1}^n (x_i - \bar{x})^2}$$

And the function  $\Phi_{(x)}$  is the cumulative distribution function (CDF) of the standard normal PDF.  $\Phi_{(x)}$  is also available in MSExcel as NORMDIST( $x$ ) for a standard normal distribution of mean  $x$  and standard deviation  $s$ .

As both the mean ( $\mu$ ) and variance ( $\sigma^2$ ) are unknown, D'Agostino (1986) proposed a modified A-D test ( $A^{*2}$ ):

$$A^{*2} = A^2 \left( 1 + \frac{0.75}{n} + \frac{2.25}{n^2} \right)$$

Normality is rejected if  $A^{*2}$  exceeds the critical value.

The test was applied to the lognormal data referring to the 5 climate zones for a significance level of 5% ( $\alpha=0.05$ ) with a critical value of 0.752. Therefore, at the critical region of the distribution, normality is rejected ( $H_0$ ) if  $A^2 > 0.752$ . The results are shown in Table 3.9.

The log-normality test applied to the 'global' region was performed for a significance level of 10% ( $\alpha=0.1$ ) with a critical value of 0.631. The result is shown in Table 3.9.

**Table 3.9.** Results of the Anderson-Darling test (modified version) for good-of-fitness statistics of the sensitivity data per geographical unit.

Region	$\alpha$	Crit. value	$A^{*2}$	$H_0$	Result
Global	0.1	0.631	0.268	✓	Log-normality of data not discarded
Climate zone	$\alpha$	Crit. value	$A^{*2}$	$H_0$	Result
Polar	0.05	0.752	0.646	✓	Log-normality of data not discarded
Subpolar	0.05	0.752	0.756	×	Log-normality rejected with 95% confidence
	0.025	0.873		✓	Log-normality of data not discarded ( $\alpha=0.025$ )
Temperate	0.05	0.752	0.309	✓	Log-normality of data not discarded
Subtropical	0.05	0.752	0.320	✓	Log-normality of data not discarded
Tropical	0.05	0.752	0.585	✓	Log-normality of data not discarded

The A-D test results show that the distribution of the sensitivity data ( $EC_{50}$ ) for the 'Global' region at a 90% significance level has no significant departures from normality. Similarly, log-normality cannot be rejected for the data from all the climate zones at a significant level of 5%, except for the 'Subpolar' climate zone, which failed the normality test at this level. The rejection of normality for the 'Subpolar' climate zone may be related to the number of highly tolerant species (*ca.* 40% of species show  $HC_{50} \leq 1$  mg/L) and occurrence of several ties in the data.

### Appendix 3-VI: Generation of Species Sensitivity Distributions (SSD)

The estimation of Species Sensitivity Distributions (SSD) curves used the USEPA’s SSD generator (USEPA 2004) for its easiness of application and transparent calculations.

Briefly the method involves three basic steps (USEPA 2004):

- a) Selection of data for the exposure intensities at which different species exhibit a standard response to the stressor.
- b) Calculation of proportions by first ranking these data from lowest to highest, then converting ranks to proportions:  $Proportion = \frac{rank-0.5}{NumSpecies}$
- c) Fitting a statistical or empirical distribution to: *Proportion (Y axis) vs. Stressor Intensity (X axis)*

The following steps of the calculations (Box 3.2) are directly extracted from the generator’s “How are SSDs generated” page.

#### Box 3.2. Generation of SSDs (USEPA 2004).

A – Regress  $\log_{10} Mean(X axis) * Probit(Y axis)$  to obtain central tendency.

- 1) Calculate the *Mean* and  $\log_{10}$  of the mean for each taxon (Obs). A geometric mean may be more appropriate for highly skewed data, but this may give an outlier excessive weight if there are few data.

The arithmetic mean is given by:  $(x_1 + x_2 + x_3 \dots x_n)/n$

The geometric mean is given by:  $(x_1 * x_2 * x_3 \dots x_n)^{1/n}$

- 2) Convert ranks to proportions:  $Proportion = \frac{rank-0.5}{NumSpecies}$
- 3) Transform proportions to probit. The probit is the inverse cumulative distribution function of the normal distribution with a mean of 5 and a standard deviation of 1. A mean of 5 is chosen to ensure that all probit values are non-negative.
- 4) Calculate the slope and intercept for:  $\log_{10} Mean(X axis) * Probit(Y axis)$
- 5) Calculate the  $\log_{10} CentralTendency (Pred)$  for the regression line:

$$\log_{10} CentralTendency = \frac{Probit - Intercept}{Slope}$$

Taxa	Step 1		Step 2		Step 3	Step 5
	Mean	Log10 Mean (Obs)	Rank	Proportion	Probit	Central Tend. (Pred)
<i>Ictalurus punctatus</i>	1.32	0.1215	1	0.1	3.72	0.1194
<i>Lepomis gibbosus</i>	2.20	0.3424	2	0.3	4.48	0.3082
<i>Danio rerio</i>	2.50	0.3979	3	0.5	5.00	0.4389
<i>Lepomis cyanellus</i>	3.68	0.5658	4	0.7	5.52	0.5696
<i>Lepomis macrochirus</i>	5.84	0.7667	5	0.9	6.28	0.7583

Step 4:	Slope	Intercept
	4.01	3.24

Step 5 ex.  $\frac{(3.72 - 3.24)}{4.01} = 0.1194$

B – Calculate Prediction Intervals (after Neter *et al.* 1990).

- 6) Calculate the *Mean Squared Error (MSE)*: For each taxon, subtract the observed  $\log_{10} Mean(Obs)$  from the  $\log_{10} CentralTendency(Pred)$ , square, add these values and divide by  $n - 2$ . In this case with 5 taxa, divide by 3.



- 7) Calculate the *Corrected Sum of Squares (CSSQ)*: For each taxon, square each probit value then sum (this is the sum of squares). Next, sum the probit values for all taxa, square that and divide by the number of taxa (this is the average sum squared). Subtract the average sum squared from the total sum of squares to get the CSSQ.
- 8) Calculate the *GrandMean* - this is the average of all log<sub>10</sub> exposure values.
- 9) Calculate the *PointError*:

$$\frac{MSE}{Slope^2} * \left(1 + \frac{1}{n} + \frac{(Pred - GrandMean)^2}{CSSQ}\right)$$

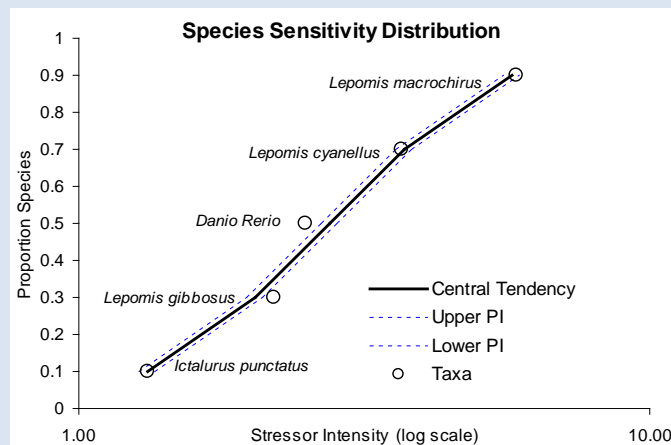
- 10) Calculate the prediction intervals (*PI*) using the critical *t* value (for *n* = 5, *tCrit* = 2.02)

$$\log_{10} PI = \log_{10} CentralTendency \pm t_{crit} * \sqrt{PointError}$$

- 11) Back convert from log value: 10<sup>value</sup>

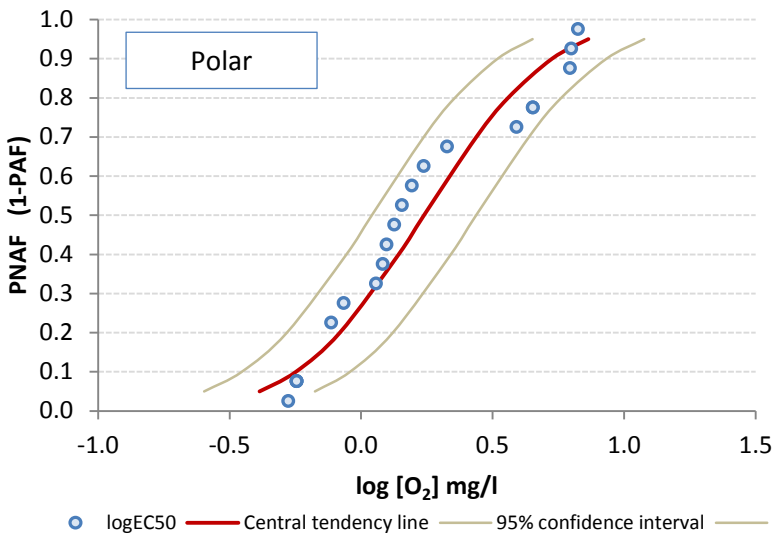
Taxa	Step 6	Step 7	Step 9 Point Error	Step 10		Step 11		
	(Obs-Pred) <sup>2</sup>	Probit <sup>2</sup>		log10 Upper PI	log 10 Lower PI	Central Tendency	Upper PI	Lower PI
<i>Ictalurus punctatus</i>	4.13E-06	13.83	4.48E-05	0.13	0.11	1.32	1.36	1.28
<i>Lepomis gibbosus</i>	1.17E-03	20.03	4.40E-05	0.32	0.29	2.03	2.10	1.97
<i>Danio rerio</i>	1.68E-03	25.00	4.38E-05	0.45	0.43	2.75	2.83	2.66
<i>Lepomis cyanellus</i>	1.40E-05	30.52	4.40E-05	0.58	0.56	3.71	3.83	3.60
<i>Lepomis macrochirus</i>	7.03E-05	39.46	4.48E-05	0.77	0.74	5.73	5.91	5.56
<b>MSE= Σ/n = 5.88E-04</b>		<b>Σ = 128.83</b>						
<b>(Σprobit)<sup>2</sup>/n = 125.00</b>								
<b>CSSQ = 3.83</b>								
			<b>Step 8: Grand Mean ΣObs/n = 0.44</b>					

Plot results: (example with the data and calculations above)

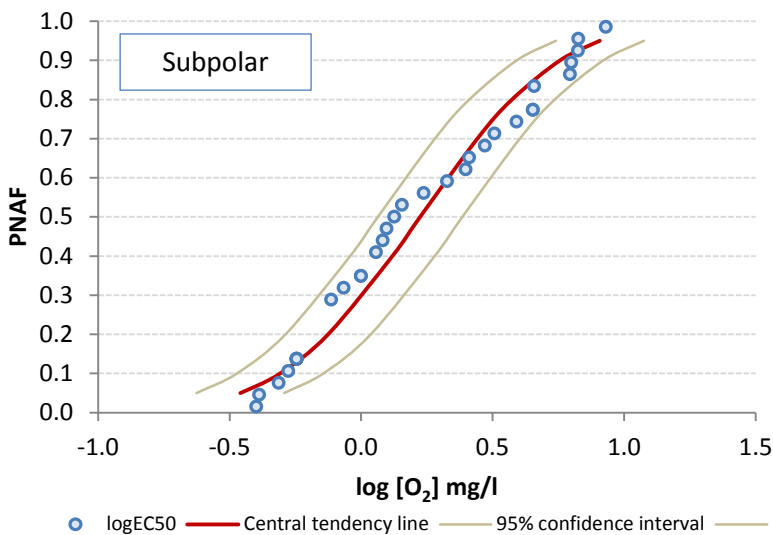


### Appendix 3-VII: Species Sensitivity Distribution (SSD) curves

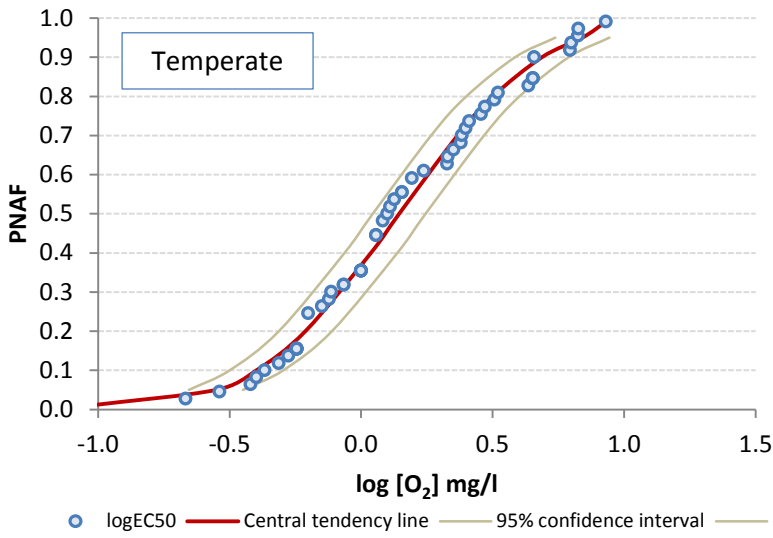
The Potentially Not-Affected Fraction of species (PNAF) is introduced instead of Potentially Affected Fraction of species (PAF), where  $PNAF=1-PAF$ , as the environmental stressor is hypoxia, thus meaning that a higher effect is expected with decreasing concentration of dissolved oxygen (instead of increasing concentration of a traditional contaminant).



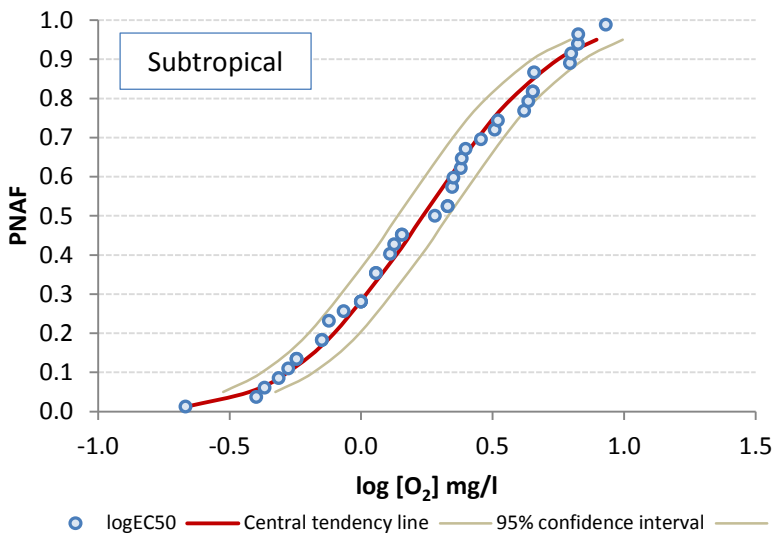
**Figure 3.7.** Species Sensitivity Distribution (SSD) (based on  $EC_{50}$  to dissolved oxygen concentrations) for 'Polar' climate zone species:  $HC_{50EC50}=1.66$   $mgO_2/L$  ( $R^2=0.92$ ).



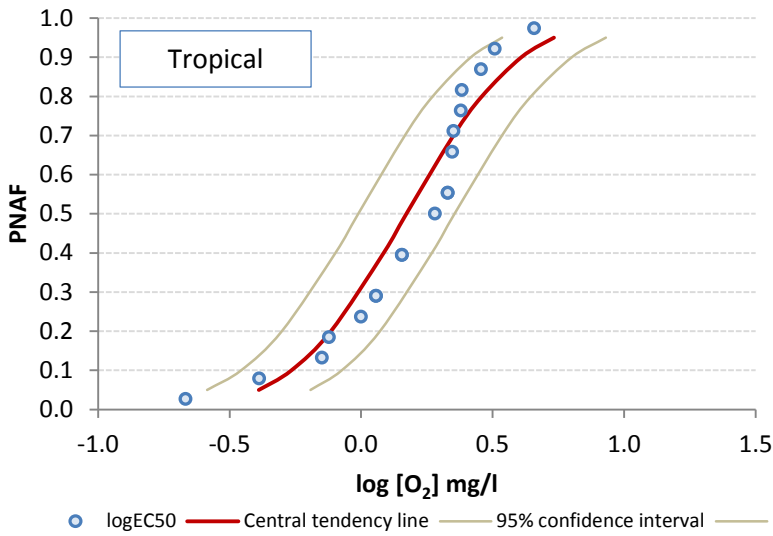
**Figure 3.8.** Species Sensitivity Distribution (SSD) (based on  $EC_{50}$  to dissolved oxygen concentrations) for 'Subpolar' climate zone species:  $HC_{50EC50}=1.61$   $mgO_2/L$  ( $R^2=0.95$ ).



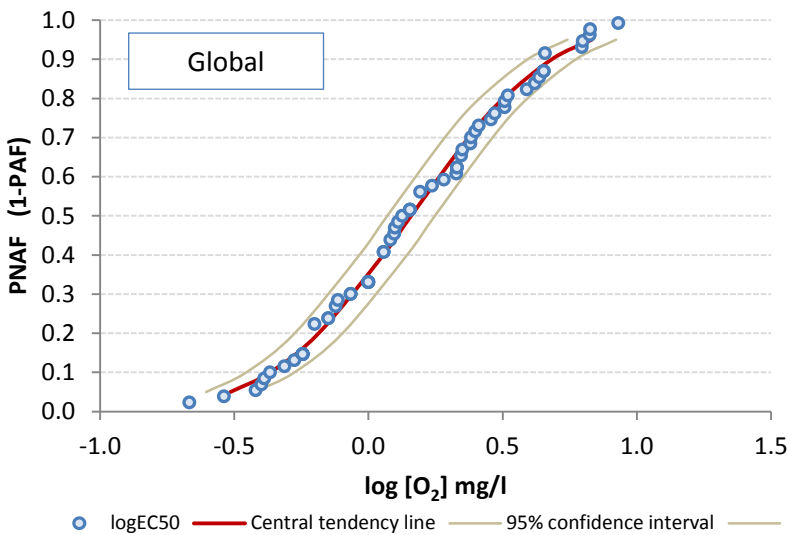
**Figure 3.9.** Species Sensitivity Distribution (SSD) (based on EC<sub>50</sub> to dissolved oxygen concentrations) for 'Temperate' climate zone species: HC<sub>50EC50</sub>=1.36 mgO<sub>2</sub>/L (R<sup>2</sup>=0.98).



**Figure 3.10.** Species Sensitivity Distribution (SSD) (based on EC<sub>50</sub> to dissolved oxygen concentrations) for 'Subtropical' climate zone species: HC<sub>50EC50</sub>=1.69 mgO<sub>2</sub>/L (R<sup>2</sup>=0.98).



**Figure 3.11.** Species Sensitivity Distribution (SSD) (based on EC<sub>50</sub> to dissolved oxygen concentrations) for ‘Tropical’ climate zone species: HC<sub>50EC50</sub>=1.46 mgO<sub>2</sub>/L (R<sup>2</sup>=0.91).



**Figure 3.12.** Species Sensitivity Distribution (SSD) (based on EC<sub>50</sub> to dissolved oxygen concentrations) – ‘Global’ zone: HC<sub>50EC50</sub>=1.41 mgO<sub>2</sub>/L (R<sup>2</sup>=0.98).

**Table 3.10:** Summarised results obtained from the Species Sensitivity Distribution (SSD) method.

Climate zone	LME	taxa	n	α	β	Slope	Inters.	R <sup>2</sup>	mgO <sub>2</sub> /L	kgO <sub>2</sub> /m <sup>3</sup>	PAF.m <sup>3</sup> /kgO <sub>2</sub>
									HC50	mg/L	EF
Polar	11	20	20	0.220	0.344	2.632	4.371	0.924	<b>1.661</b>	1.66E-03	<b>3.01E+02</b>
Subpolar	7	33	33	0.207	0.541	2.408	4.460	0.954	<b>1.611</b>	1.61E-03	<b>3.10E+02</b>
Temperate	16	55	55	0.133	0.723	2.361	4.659	0.981	<b>1.357</b>	1.36E-03	<b>3.68E+02</b>
Subtropical	13	41	41	0.228	0.554	2.492	4.414	0.981	<b>1.691</b>	1.69E-03	<b>2.96E+02</b>
Tropical	17	19	19	0.165	0.247	2.932	4.495	0.914	<b>1.461</b>	1.46E-03	<b>3.42E+02</b>
Global	64	65	65	0.149	0.735	2.443	4.612	0.984	<b>1.409</b>	1.41E-03	<b>3.55E+02</b>

### Appendix 3-VIII: Residence time variation range

**Table 3.11:** Criteria used in the uncertainty estimation of the residence time in the marine-N loss rate. Criteria used to define the residence time variation range.

Abbreviations used: ‘cont shelf’ (continental shelf), ‘avg depth’ (average depth), ‘curr exp’ (current exposition). The references for the sources mentioned match the ones listed in Table 3.6.

LME #_name	LME properties			Residence time		Variation range			Reference source
	cont shelf	avg depth	curr exp	archetype	used [yr]	Min	Max	Notes	
1. East Bering Sea	broad	shallow	+	2	2.00	0.25	25.00	arch / arch	
2. Gulf of Alaska	narrow	deep	+	1	0.25	0.13	2.00	-50% / arch	
3. California Current	medium	sh-de	+	1	0.25	0.13	2.00	-50% / arch	
4. Gulf of California	medium	sh-de	-	1-2	1.50	0.25	2.00	arch / arch	Lopez & Garcia (2003)
5. Gulf of Mexico	medium	sh-de	+	4	90.00	0.17	250.00	lit / lit	Turner & Rabalais (2009); USGS (2012); Rivas et al. (2005)
6. Southeast U.S. Continental Shelf	broad	shallow	+	1	0.25	0.13	2.00	-50% / arch	Alegria et al. (2000)
7. Northeast U.S. Continental Shelf	broad	shallow	++	1	0.25	0.13	2.00	-50% / arch	
8. Scotian Shelf	broad	shallow	++	1	0.88	0.44	2.00	-50% / arch	Smith et al. (2003)
9. Newfoundland-Labrador Shelf	broad	shallow	+	1	0.25	0.13	2.00	-50% / arch	
10. Insular Pacific-Hawaiian	narrow	deep	++	1	0.25	0.13	2.00	-50% / arch	
11. Pacific Central-American	narrow	deep	++	1	0.25	0.13	2.00	-50% / arch	
12. Caribbean Sea	narrow	deep	++	1	0.21	0.10	0.25	-50% / arch	Molinari et al. (1980)
13. Humboldt Current	narrow	deep	++	1	0.03	0.02	0.25	lit / arch	Hall et al. (1996)
14. Patagonian Shelf	broad	shallow	+	1	0.25	0.13	2.00	-50% / arch	
15. South Brazil Shelf	narrow	deep	++	1	0.25	0.13	2.00	-50% / arch	
16. East Brazil Shelf	narrow	deep	++	1	0.25	0.13	2.00	-50% / arch	Attisano et al. (2008)
17. North Brazil Shelf	medium	sh-de	++	1	0.25	0.01	0.38	lit / +50%	Limeburner et al. (1995)
18. West Greenland Shelf	medium	deep	+	1	0.25	0.13	2.00	-50% / arch	
19. East Greenland Shelf	medium	deep	+	1	0.25	0.13	2.00	-50% / arch	
20. Barents Sea	broad	shallow	+	2	2.00	0.25	25.00	arch / arch	
21. Norwegian Sea	broad	sh-de	+	2	2.00	0.25	25.00	arch / arch	
22. North Sea	broad	shallow	+	2	2.00	0.25	3.00	arch / +50%	Blaas et al. (2001)
23. Baltic Sea	broad	shallow	-	1	25.00	25.00	35.00	-50% / lit	Jansson B-O (1980); Matthäus & Schinke (1999)
24. Celtic-Biscay Shelf	broad	sh-de	+	2	2.00	0.25	3.00	arch / +50%	
25. Iberian Coastal	medium	deep	+	1	0.25	0.13	2.00	-50% / arch	
26. Mediterranean	medium	sh-de	-	4	90.00	25.00	135.00	arch / +50%	Pinet PR (2008)
27. Canary Current	narrow	deep	++	1	0.25	0.13	2.00	-50% / arch	
28. Guinea Current	narrow	deep	++	2	3.10	2.00	4.65	arch / +50%	Hall et al. (1996)
29. Benguela Current	narrow	deep	++	1	0.25	0.13	2.00	-50% / arch	
30. Agulhas Current	narrow	deep	++	2	2.00	0.25	3.00	arch / +50%	
31. Somali Coastal Current	narrow	deep	++	1	0.25	0.13	2.00	-50% / arch	INaqvi (2012)
32. Arabian Sea	narrow	deep	+	2-3	6.50	2.00	9.75	arch / +50%	Sarma (2002)
33. Red Sea	broad	sh-de	-	1	40.00	10.00	70.00	lit / lit	Smeed (2010); Grasshoff (1969); Tomczak & Godfrey (2003)
34. Bay of Bengal	narrow	deep	+	2-3	12.00	2.00	25.00	arch / arch	Sarma (2002)
35. Gulf of Thailand	broad	shallow	-	1-2	0.04	0.02	2.00	-50% / arch	Dulaiova et al. (2006)
36. South China Sea	broad	shallow	-	3	25.00	2.00	90.00	arch / arch	
37. Sulu-Celebes Sea	broad	sh-de	+	3	25.00	2.00	37.50	arch / +50%	Tessler (2012); Tessler et al. (2011).
38. Indonesian Sea	broad	shallow	+	1-2	0.75	0.50	2.00	-50% / arch	Field & Gordon (1992)
39. North Australia	broad	shallow	+	1	0.25	0.13	2.00	-50% / arch	
40. Northeast Australia	broad	shallow	+	1	0.25	0.04	2.00	lit / arch	Choukroun et al. (2010)
41. East-Central Australia	narrow	shallow	+	1	0.25	0.13	2.00	-50% / arch	
42. Southeast Australia	medium	sh-de	+	1	0.25	0.13	2.00	-50% / arch	
43. Southwest Australia	narrow	sh-de	+	1	0.25	0.13	2.00	-50% / arch	
44. West-Central Australia	medium	sh-de	+	1	0.25	0.13	2.00	-50% / arch	
45. Northwest Australia	medium	sh-de	+	1	0.25	0.13	2.00	-50% / arch	
46. New Zealand Shelf	broad	shallow	+	1	0.25	0.13	2.00	-50% / arch	
47. East China Sea	medium	sh-de	-	1	1.90	0.80	2.60	lit / lit	Tsunogai et al. (1997); Tomczak & Godfrey (2003); Hall et al. (1996)
48. Yellow Sea	broad	shallow	-	1	2.00	0.80	2.30	lit / lit	Tsunogai et al. (1997); Tomczak & Godfrey (2003)
49. Kuroshio Current	narrow	deep	++	1	2.30	1.15	3.45	-50% / +50%	Matsuno et al. (2009)
50. Sea of Japan/East Sea	broad	shallow	-	3	25.00	2.00	90.00	arch / arch	
51. Oyashio Current	narrow	deep	++	1	0.25	0.13	2.00	-50% / arch	
52. Sea of Okhotsk	broad	shallow	-	2	2.00	0.25	25.00	arch / arch	Yamamoto et al. (2001)
53. West Bering Sea	narrow	deep	+	1	0.25	0.13	2.00	-50% / arch	
54. Chukchi Sea	broad	shallow	+	1	3.50	1.50	5.50	lit / lit	Schlosser et al. (1994)
55. Beaufort Sea	broad	shallow	+	1	3.50	1.50	5.50	lit / lit	Schlosser et al. (1994)
56. East Siberian Sea	broad	shallow	+	1	3.50	1.50	5.50	lit / lit	Schlosser et al. (1994)
57. Laptev Sea	broad	shallow	+	1	3.50	1.50	5.50	lit / lit	Schlosser et al. (1994)
58. Kara Sea	broad	shallow	+	1	3.50	1.50	5.50	lit / lit	Schlosser et al. (1994)
59. Iceland Shelf	narrow	deep	+	1	0.25	0.13	2.00	-50% / arch	
60. Faroe Plateau	broad	shallow	++	1	0.25	0.13	2.00	-50% / arch	Gaard (2000)
61. Antarctic	narrow	deep	+	2-3	6.00	2.00	25.00	arch / arch	Jacobs et al. (1985)
62. Black Sea	broad	shallow	-	4	90.00	25.00	135.00	arch / +50%	Murray et al. (2007)
63. Hudson Bay	broad	shallow	-	2-3	6.60	2.00	25.00	arch / arch	Ingram & Prinsenberg (1998)
64. Arctic Ocean	--	--	++	2-3	11.00	2.00	25.00	arch / arch	Jahn et al. (2010)

Continental shelves' bathymetry consulted from Liu et al. (2012).

Appendix 3-IX: Fate

Table 3.12: Fate Factors (FF) per emission route for Countries and Countries-to-LME scales.

ISO #	Country	Country-to-LME	unit:	emission route:				spatial scale:						
				N to Air		N to sfw		N to gw		N to mw				
				Country	Country-to-LME	Country	Country-to-LME	Country	Country-to-LME	Country	Country-to-LME			
8	Albania	Albania to LME#26. Mediterranean		d	d	d	d	d	d	d	d	d	d	d
12	Algeria	Algeria to LME#26. Mediterranean		281.75	281.75	412.24	412.24	145.95	145.95	871.55	871.55	871.55	871.55	871.55
24	Angola	Angola to LME#29. Benguela Current		267.13	267.13	412.24	412.24	145.95	145.95	871.55	871.55	871.55	871.55	871.55
32	Argentina	Argentina to LME#14. Patagonian Shelf		21.15	21.15	39.19	39.19	13.88	13.88	82.86	82.86	82.86	82.86	82.86
36	Australia	Australia to LME#39. North Australia		29.88	29.88	39.19	39.19	13.88	13.88	82.86	82.86	82.86	82.86	82.86
		Australia to LME#40. Northeast Australia		13.71	1.96	274.35	39.19	97.13	13.88	580.03	82.86	82.86	82.86	82.86
		Australia to LME#41. East-Central Australia			1.96		39.19		13.88		82.86	82.86	82.86	82.86
		Australia to LME#42. Southeast Australia			1.96		39.19		13.88		82.86	82.86	82.86	82.86
		Australia to LME#43. Southwest Australia			1.96		39.19		13.88		82.86	82.86	82.86	82.86
		Australia to LME#44. West-Central Australia			1.96		39.19		13.88		82.86	82.86	82.86	82.86
		Australia to LME#45. Northwest Australia			1.96		39.19		13.88		82.86	82.86	82.86	82.86
40	Austria	Austria to LME#26. Mediterranean		221.76	221.76	412.24	412.24	145.95	145.95	871.55	871.55	871.55	871.55	871.55
44	Bahamas	Bahamas to LME#12. Caribbean Sea		41.98	41.98	32.75	32.75	11.60	11.60	69.25	69.25	69.25	69.25	69.25
50	Bangladesh	Bangladesh to LME#34. Bay of Bengal		184.52	184.52	351.64	351.64	124.50	124.50	743.43	743.43	743.43	743.43	743.43
56	Belgium	Belgium to LME#22. North Sea		127.00	127.00	190.27	190.27	67.36	67.36	402.27	402.27	402.27	402.27	402.27
64	Bhutan	Bhutan to LME#34. Bay of Bengal		161.86	161.86	351.64	351.64	124.50	124.50	743.43	743.43	743.43	743.43	743.43
68	Bolivia	Bolivia to LME#13. Humboldt Current		2.61	2.61	5.14	5.14	1.82	1.82	10.87	10.87	10.87	10.87	10.87
70	Bosnia and Herzegovina	Bosnia and Herzegovina to LME#26. Mediterranean		238.30	238.30	412.24	412.24	145.95	145.95	871.55	871.55	871.55	871.55	871.55
72	Botswana	Botswana to LME#30. Agulhas Current		113.53	113.53	190.27	190.27	67.36	67.36	402.27	402.27	402.27	402.27	402.27
76	Brazil	Brazil to LME#15. South Brazil Shelf		14.93	4.98	117.58	39.19	41.63	13.88	248.58	82.86	82.86	82.86	82.86
		Brazil to LME#16. East Brazil Shelf			4.98		39.19		13.88		82.86	82.86	82.86	82.86
		Brazil to LME#17. North Brazil Shelf			4.98		39.19		13.88		82.86	82.86	82.86	82.86
84	Belize	Belize to LME#12. Caribbean Sea		30.89	30.89	32.75	32.75	11.60	11.60	69.25	69.25	69.25	69.25	69.25
92	Virgin Islands (British)	Virgin Islands (British) to LME#12. Caribbean Sea		47.65	47.65	32.75	32.75	11.60	11.60	69.25	69.25	69.25	69.25	69.25
100	Bulgaria	Bulgaria to LME#26. Mediterranean		172.65	86.33	824.49	412.24	291.90	145.95	1,743.11	871.55	871.55	871.55	871.55
		Bulgaria to LME#62. Black Sea			86.33		412.24		145.95		871.55	871.55	871.55	871.55
104	Myanmar	Myanmar to LME#34. Bay of Bengal		199.90	199.90	351.64	351.64	124.50	124.50	743.43	743.43	743.43	743.43	743.43
112	Belarus	Belarus to LME#23. Baltic Sea		161.35	161.35	385.66	385.66	136.54	136.54	815.35	815.35	815.35	815.35	815.35
116	Cambodia	Cambodia to LME#3. California Current		28.28	28.28	39.19	39.19	13.88	13.88	82.86	82.86	82.86	82.86	82.86
120	Cameroon	Cameroon to LME#28. Guinea Current		119.54	119.54	236.48	236.48	83.72	83.72	499.97	499.97	499.97	499.97	499.97
124	Canada	Canada to LME#2. Gulf of Alaska		54.42	2.52	844.88	39.19	299.12	13.88	1,786.22	82.86	82.86	82.86	82.86
		Canada to LME#63. Hudson Bay			19.89		308.79		109.32		652.83	652.83	652.83	652.83
		Canada to LME#9. Newfoundland-Labrador Shelf			2.52		39.19		13.88		82.86	82.86	82.86	82.86
		Canada to LME#8. Scotian Shelf			7.18		111.40		39.44		235.52	235.52	235.52	235.52
		Canada to LME#64. Arctic Ocean			22.31		346.30		122.60		732.14	732.14	732.14	732.14
144	Sri Lanka	Sri Lanka to LME#34. Bay of Bengal		430.80	430.80	351.64	351.64	124.50	124.50	743.43	743.43	743.43	743.43	743.43
152	Chile	Chile to LME#13. Humboldt Current		4.50	4.50	5.14	5.14	1.82	1.82	10.87	10.87	10.87	10.87	10.87
156	China, People's Republic of	China, People's Republic of to LME#36. South China Sea		100.84	51.11	760.85	385.66	269.37	136.54	1,608.56	815.35	815.35	815.35	815.35
		China, People's Republic of to LME#47. East China Sea			24.51		184.92		65.47		390.94	390.94	390.94	390.94
		China, People's Republic of to LME#48. Yellow Sea			25.22		190.27		67.36		402.27	402.27	402.27	402.27
170	Colombia	Colombia to LME#11. Pacific Central-American		17.73	9.66	71.95	39.19	25.47	13.88	152.11	82.86	82.86	82.86	82.86
		Colombia to LME#12. Caribbean Sea			8.07		32.75		11.60		69.25	69.25	69.25	69.25
178	Congo	Congo to LME#28. Guinea Current		122.64	122.64	236.48	236.48	83.72	83.72	499.97	499.97	499.97	499.97	499.97
180	Democratic Republic of the Congo	Democratic Republic of the Congo to LME#28. Guinea Current		100.30	100.30	236.48	236.48	83.72	83.72	499.97	499.97	499.97	499.97	499.97
188	Costa Rica	Costa Rica to LME#11. Pacific Central-American		25.21	13.74	71.95	39.19	25.47	13.88	152.11	82.86	82.86	82.86	82.86
		Costa Rica to LME#12. Caribbean Sea			11.48		32.75		11.60		69.25	69.25	69.25	69.25
191	Croatia	Croatia to LME#26. Mediterranean		234.07	234.07	412.24	412.24	145.95	145.95	871.55	871.55	871.55	871.55	871.55
192	Cuba	Cuba to LME#12. Caribbean Sea		40.71	40.71	32.75	32.75	11.60	11.60	69.25	69.25	69.25	69.25	69.25
196	Cyprus	Cyprus to LME#26. Mediterranean		327.53	327.53	412.24	412.24	145.95	145.95	871.55	871.55	871.55	871.55	871.55
203	Czech Republic	Czech Republic to LME#22. North Sea		97.47	97.47	190.27	190.27	67.36	67.36	402.27	402.27	402.27	402.27	402.27
204	Benin	Benin to LME#28. Guinea Current		148.76	148.76	236.48	236.48	83.72	83.72	499.97	499.97	499.97	499.97	499.97
208	Denmark	Denmark to LME#22. North Sea		90.47	27.98	615.13	190.27	217.78	67.36	1,300.48	402.27	402.27	402.27	402.27
		Denmark to LME#23. Baltic Sea			56.72		385.66		136.54		815.35	815.35	815.35	815.35
		Denmark to LME#60. Faroe Plateau			5.76		39.19		13.88		82.86	82.86	82.86	82.86
214	Dominican Republic	Dominican Republic to LME#12. Caribbean Sea		43.53	43.53	32.75	32.75	11.60	11.60	69.25	69.25	69.25	69.25	69.25
218	Ecuador	Ecuador to LME#11. Pacific Central-American		28.09	28.09	39.19	39.19	13.88	13.88	82.86	82.86	82.86	82.86	82.86
222	El Salvador	El Salvador to LME#11. Pacific Central-American		38.70	38.70	39.19	39.19	13.88	13.88	82.86	82.86	82.86	82.86	82.86
226	Equatorial Guinea	Equatorial Guinea to LME#28. Guinea Current		159.30	159.30	236.48	236.48	83.72	83.72	499.97	499.97	499.97	499.97	499.97
231	Ethiopia	Ethiopia to LME#32. Arabian Sea		135.64	59.04	706.53	307.51	250.14	108.87	1,493.72	650.13	650.13	650.13	650.13
		Ethiopia to LME#33. Red Sea			76.60		399.02		141.27		843.60	843.60	843.60	843.60
232	Eritrea	Eritrea to LME#33. Red Sea		220.58	220.58	399.02	399.02	141.27	141.27	843.60	843.60	843.60	843.60	843.60
233	Estonia	Estonia to LME#23. Baltic Sea		208.21	208.21	385.66	385.66	136.54	136.54	815.35	815.35	815.35	815.35	815.35
238	Falkland Islands (Malvinas)	Falkland Islands (Malvinas) to LME#14. Patagonian Shelf		62.16	62.16	39.19	39.19	13.88	13.88	82.86	82.86	82.86	82.86	82.86
246	Finland	Finland to LME#23. Baltic Sea		208.79	208.79	385.66	385.66	136.54	136.54	815.35	815.35	815.35	815.35	815.35
250	France	France to LME#22. North Sea		108.99	26.16	792.79	190.27	280.68	67.36	1,676.10	402.27	402.27	402.27	402.27
		France to LME#24. Celtic-Biscay Shelf			26.16		190.27		67.36		402.27	402.27	402.27	402.27
		France to LME#26. Mediterranean			56.67		412.24		145.95		871.55	871.55	871.55	871.55
262	Djibouti	Djibouti to LME#32. Arabian Sea		187.73	187.73	307.51	307.51	108.87	108.87	650.13	650.13	650.13	650.13	650.13
266	Gabon	Gabon to LME#28. Guinea Current		148.37	148.37	236.48	236.48	83.72	83.72	499.97	499.97	499.97	499.97	499.97
268	Georgia	Georgia to LME#62. Black Sea		171.09	171.09	412.24	412.24	145.95	145.95	871.55	871.55	871.55	871.55	871.55
270	Gambia	Gambia to LME#28. Guinea Current		223.61	223.61	236.48	236.48	83.72	83.72	499.97	499.97	499.97	499.97	499.97
276	Germany	Germany to LME#22. North Sea		123.98	40.96	575.93	190.27	203.90	67.36	1,217.62	402.27	402.27	402.27	402.27
		Germany to LME#23. Baltic Sea			83.02		385.66		136.54		815.35	815.35	815.35	815.35

368	Iraq	Iraq to LME#32. Arabian Sea	131.70	131.70	307.51	307.51	108.87	108.87	650.13	650.13
372	Ireland	Ireland to LME#24. Celtic-Biscay Shelf	193.70	193.70	190.27	190.27	67.36	67.36	402.27	402.27
376	Israel	Israel to LME#26. Mediterranean	227.01	227.01	412.24	412.24	145.95	145.95	871.55	871.55
380	Italy	Italy to LME#26. Mediterranean	287.25	287.25	412.24	412.24	145.95	145.95	871.55	871.55
381	Kosovo	Kosovo to LME#26. Mediterranean	222.44	222.44	412.24	412.24	145.95	145.95	871.55	871.55
384	Côte d'Ivoire	Côte d'Ivoire to LME#28. Guinea Current	178.22	178.22	236.48	236.48	83.72	83.72	499.97	499.97
388	Jamaica	Jamaica to LME#12. Caribbean Sea	44.23	44.23	32.75	32.75	11.60	11.60	69.25	69.25
392	Japan	Japan to LME#47. East China Sea	91.88	16.90	1,005.04	184.92	355.82	65.47	2,124.82	390.94
		Japan to LME#49. Kuroshio Current		18.74		205.00		72.58		433.40
		Japan to LME#50. Sea of Japan/East Sea		35.26		385.66		136.54		815.35
		Japan to LME#51. Oyashio Current		3.58		39.19		13.88		82.86
		Japan to LME#52. Sea of Okhotsk		17.39		190.27		67.36		402.27
400	Jordan	Jordan to LME#33. Red Sea	190.90	190.90	399.02	399.02	141.27	141.27	843.60	843.60
404	Kenya	Kenya to LME#31. Somali Coastal Current	20.86	20.86	39.19	39.19	13.88	13.88	82.86	82.86
408	Democratic People's Republic of Korea	Democratic People's Republic of Korea to LME#47. East China Sea	119.12	28.95	760.85	184.92	269.37	65.47	1,608.56	390.94
		Democratic People's Republic of Korea to LME#48. Yellow Sea		29.79		190.27		67.36		402.27
		Democratic People's Republic of Korea to LME#50. Sea of Japan/East Sea		60.38		385.66		136.54		815.35
410	Republic of Korea	Republic of Korea to LME#47. East China Sea	130.24	31.65	760.85	184.92	269.37	65.47	1,608.56	390.94
		Republic of Korea to LME#48. Yellow Sea		32.57		190.27		67.36		402.27
		Republic of Korea to LME#50. Sea of Japan/East Sea		66.02		385.66		136.54		815.35
418	Lao People's Democratic Republic	Lao People's Democratic Republic to LME#36. South China Sea	255.54	255.54	385.66	385.66	136.54	136.54	815.35	815.35
422	Lebanon	Lebanon to LME#26. Mediterranean	238.53	238.53	412.24	412.24	145.95	145.95	871.55	871.55
428	Latvia	Latvia to LME#23. Baltic Sea	193.58	193.58	385.66	385.66	136.54	136.54	815.35	815.35
430	Liberia	Liberia to LME#28. Guinea Current	210.50	210.50	236.48	236.48	83.72	83.72	499.97	499.97
434	Libyan Arab Jamahiriya	Libyan Arab Jamahiriya to LME#26. Mediterranean	233.79	233.79	412.24	412.24	145.95	145.95	871.55	871.55
440	Lithuania	Lithuania to LME#23. Baltic Sea	181.06	181.06	385.66	385.66	136.54	136.54	815.35	815.35
450	Madagascar	Madagascar to LME#30. Agulhas Current	168.72	168.72	190.27	190.27	67.36	67.36	402.27	402.27
458	Malaysia	Malaysia to LME#34. Bay of Bengal	132.07	62.44	743.83	351.64	263.34	124.50	1,572.58	743.43
		Malaysia to LME#35. Gulf of Thailand		1.16		6.52		2.31		13.79
		Malaysia to LME#36. South China Sea		68.48		385.66		136.54		815.35
466	Mali	Mali to LME#27. Canary Current	65.89	9.37	275.68	39.19	97.60	13.88	582.83	82.86
		Mali to LME#28. Guinea Current		56.52		236.48		83.72		499.97
478	Mauritania	Mauritania to LME#27. Canary Current	30.38	30.38	39.19	39.19	13.88	13.88	82.86	82.86
484	Mexico	Mexico to LME#3. California Current	92.16	5.90	612.20	39.19	216.74	13.88	1,294.30	82.86
		Mexico to LME#4. Gulf of California		24.20		160.76		56.92		339.88
		Mexico to LME#5. Gulf of Mexico		62.06		412.24		145.95		871.55
498	Moldova	Moldova to LME#62. Black Sea	195.55	195.55	412.24	412.24	145.95	145.95	871.55	871.55
499	Montenegro	Montenegro to LME#26. Mediterranean	222.44	222.44	412.24	412.24	145.95	145.95	871.55	871.55
504	Morocco	Morocco to LME#26. Mediterranean	116.32	106.22	451.44	412.24	159.83	145.95	954.41	871.55
		Morocco to LME#27. Canary Current		10.10		39.19		13.88		82.86
508	Mozambique	Mozambique to LME#30. Agulhas Current	121.38	121.38	190.27	190.27	67.36	67.36	402.27	402.27
512	Oman	Oman to LME#32. Arabian Sea	216.85	216.85	307.51	307.51	108.87	108.87	650.13	650.13
516	Namibia	Namibia to LME#29. Benguela Current	26.54	26.54	39.19	39.19	13.88	13.88	82.86	82.86
524	Nepal	Nepal to LME#34. Bay of Bengal	152.47	152.47	351.64	351.64	124.50	124.50	743.43	743.43
528	Netherlands	Netherlands to LME#22. North Sea	131.20	131.20	190.27	190.27	67.36	67.36	402.27	402.27
540	New Caledonia	New Caledonia to LME#40. Northeast Australia	68.65	68.65	39.19	39.19	13.88	13.88	82.86	82.86
554	New Zealand	New Zealand to LME#46. New Zealand Shelf	52.74	52.74	39.19	39.19	13.88	13.88	82.86	82.86
558	Nicaragua	Nicaragua to LME#11. Pacific Central-American	23.44	12.77	71.95	39.19	25.47	13.88	152.11	82.86
		Nicaragua to LME#12. Caribbean Sea		10.67		32.75		11.60		69.25
562	Niger	Niger to LME#28. Guinea Current	123.69	123.69	236.48	236.48	83.72	83.72	499.97	499.97
566	Nigeria	Nigeria to LME#28. Guinea Current	129.39	129.39	236.48	236.48	83.72	83.72	499.97	499.97
578	Norway	Norway to LME#21. Norwegian Sea	91.78	45.89	380.55	190.27	134.73	67.36	804.54	402.27
		Norway to LME#22. North Sea		45.89		190.27		67.36		402.27
586	Pakistan	Pakistan to LME#32. Arabian Sea	138.18	138.18	307.51	307.51	108.87	108.87	650.13	650.13
591	Panama	Panama to LME#11. Pacific Central-American	24.95	13.59	71.95	39.19	25.47	13.88	152.11	82.86
		Panama to LME#12. Caribbean Sea		11.36		32.75		11.60		69.25
600	Paraguay	Paraguay to LME#14. Patagonian Shelf	22.54	22.54	39.19	39.19	13.88	13.88	82.86	82.86
604	Peru	Peru to LME#13. Humboldt Current	3.66	3.66	5.14	5.14	1.82	1.82	10.87	10.87
608	Philippines	Philippines to LME#36. South China Sea	287.84	143.92	771.32	385.66	273.08	136.54	1,630.70	815.35
		Philippines to LME#37. Sulu-Celebes Sea		143.92		385.66		136.54		815.35
616	Poland	Poland to LME#23. Baltic Sea	189.69	189.69	385.66	385.66	136.54	136.54	815.35	815.35
620	Portugal	Portugal to LME#25. Iberian Coastal	36.50	36.50	39.19	39.19	13.88	13.88	82.86	82.86
624	Guinea-Bissau	Guinea-Bissau to LME#28. Guinea Current	210.58	210.58	236.48	236.48	83.72	83.72	499.97	499.97
626	Timor-Leste	Timor-Leste to LME#38. Indonesian Sea	145.72	145.72	99.22	99.22	35.13	35.13	209.76	209.76
630	Puerto Rico	Puerto Rico to LME#12. Caribbean Sea	45.40	45.40	32.75	32.75	11.60	11.60	69.25	69.25
642	Romania	Romania to LME#62. Black Sea	204.17	204.17	412.24	412.24	145.95	145.95	871.55	871.55
643	Russian Federation	Russian Federation to LME#20. Barents Sea	67.42	4.94	2,599.35	190.27	920.27	67.36	5,495.46	402.27
		Russian Federation to LME#54. Chukchi Sea		6.46		249.05		88.17		526.54
		Russian Federation to LME#56. East Siberian Sea		6.46		249.05		88.17		526.54
		Russian Federation to LME#57. Laptev Sea		6.46		249.05		88.17		526.54
		Russian Federation to LME#58. Kara Sea		6.46		249.05		88.17		526.54
		Russian Federation to LME#62. Black Sea		10.69		412.24		145.95		871.55
		Russian Federation to LME#64. Arctic Ocean		8.98		346.30		122.60		732.14
		Russian Federation to LME#50. Sea of Japan/East Sea		10.00		385.66		136.54		815.35
		Russian Federation to LME#51. Oyashio Current		1.02		39.19		13.88		82.86
		Russian Federation to LME#52. Sea of Okhotsk		4.94		190.27		67.36		402.27
		Russian Federation to LME#53. West Bering Sea		1.02		39.19		13.88		82.86
682	Saudi Arabia	Saudi Arabia to LME#32. Arabian Sea	133.11	57.94	706.53	307.51	250.14	108.87	1,493.72	650.13
		Saudi Arabia to LME#33. Red Sea		75.18		399.02		141.27		843.60
686	Senegal	Senegal to LME#27. Canary Current	34.74	34.74	39.19	39.19	13.88	13.88	82.86	82.86
688	Serbia	Serbia to LME#62. Black Sea	167.24	83.62	824.49	412.24	291.90	145.95	1,743.11	871.55
		Serbia to LME#26. Mediterranean		83.62		412.24		145.95		871.55
694	Sierra Leone	Sierra Leone to LME#28. Guinea Current	200.64	200.64	236.48	236.48	83.72	83.72	499.97	499.97
703	Slovakia	Slovakia to LME#62. Black Sea	197.82	197.82	412.24	412.24	145.95	145.95	871.55	871.55
704	Viet Nam	Viet Nam to LME#36. South China Sea	308.15	308.15	385.66	385.66	136.54	136.54	815.35	815.35
705	Slovenia	Slovenia to LME#26. Mediterranean	245.10	245.10	412.24	412.24	145.95	145.95	871.55	871.55
706	Somalia	Somalia to LME#31. Somali Coastal Current	85.46	9.66	346.70	39.19	122.75	13.88	732.99	82.86
		Somalia to LME#32. Arabian Sea		75.80		307.51		108.87		650.13
710	South Africa	South Africa to LME#29. Benguela Current	59.74	10.20	229.47	39.19	81.24	13.88	485.13	82.86
		South Africa to LME#30. Agulhas Current		49.54		190.27		67.36		402.27



716	Zimbabwe	Zimbabwe to LME#30. Agulhas Current	104.20	104.20	190.27	190.27	67.36	67.36	402.27	402.27
724	Spain	Spain to LME#25. Iberian Coastal	120.25	10.44	451.44	39.19	159.83	13.88	954.41	82.86
		Spain to LME#26. Mediterranean		109.81		412.24		145.95		871.55
736	Sudan	Sudan to LME#33. Red Sea	168.17	168.17	399.02	399.02	141.27	141.27	843.60	843.60
748	Swaziland	Swaziland to LME#30. Agulhas Current	132.36	132.36	190.27	190.27	67.36	67.36	402.27	402.27
752	Sweden	Sweden to LME#23. Baltic Sea	131.61	88.13	575.93	385.66	203.90	136.54	1,217.62	815.35
		Sweden to LME#22. North Sea		43.48		190.27		67.36		402.27
756	Switzerland	Switzerland to LME#22. North Sea	129.80	24.34	1,014.76	190.27	359.26	67.36	2,145.38	402.27
		Switzerland to LME#26. Mediterranean		52.73		412.24		145.95		871.55
		Switzerland to LME#62. Black Sea		52.73		412.24		145.95		871.55
760	Syrian Arab Republic	Syrian Arab Republic to LME#26. Mediterranean	192.19	192.19	412.24	412.24	145.95	145.95	871.55	871.55
764	Thailand	Thailand to LME#34. Bay of Bengal	230.69	230.69	351.64	351.64	124.50	124.50	743.43	743.43
768	Togo	Togo to LME#28. Guinea Current	159.90	159.90	236.48	236.48	83.72	83.72	499.97	499.97
784	United Arab Emirates	United Arab Emirates to LME#32. Arabian Sea	211.15	211.15	307.51	307.51	108.87	108.87	650.13	650.13
788	Tunisia	Tunisia to LME#26. Mediterranean	281.59	281.59	412.24	412.24	145.95	145.95	871.55	871.55
792	Turkey	Turkey to LME#26. Mediterranean	221.60	221.60	412.24	412.24	145.95	145.95	871.55	871.55
800	Uganda	Uganda to LME#26. Mediterranean	178.36	178.36	412.24	412.24	145.95	145.95	871.55	871.55
804	Ukraine	Ukraine to LME#62. Black Sea	181.23	181.23	412.24	412.24	145.95	145.95	871.55	871.55
807	The FYR of Macedonia	The FYR of Macedonia to LME#26. Mediterranean	242.07	242.07	412.24	412.24	145.95	145.95	871.55	871.55
818	Egypt	Egypt to LME#26. Mediterranean	205.96	205.96	412.24	412.24	145.95	145.95	871.55	871.55
826	United Kingdom of GB and NI	United Kingdom of GB and NI to LME#22. North Sea	105.48	52.74	380.55	190.27	134.73	67.36	804.54	402.27
		United Kingdom of GB and NI to LME#24. Celtic-Biscay Shelf		52.74		190.27		67.36		402.27
834	United Republic of Tanzania: Mainland	United Republic of Tanzania: Mainland to LME#30. Agulhas Current	98.90	98.90	190.27	190.27	67.36	67.36	402.27	402.27
840	United States	United States to LME#1. East Bering Sea	43.36	5.66	1,457.36	190.27	515.96	67.36	3,081.09	402.27
		United States to LME#2. Gulf of Alaska		1.17		39.19		13.88		82.86
		United States to LME#3. California Current		1.17		39.19		13.88		82.86
		United States to LME#4. Gulf of California		4.78		160.76		56.92		339.88
		United States to LME#5. Gulf of Mexico		12.27		412.24		145.95		871.55
		United States to LME#6. Southeast U.S. Continental Shelf		1.17		39.19		13.88		82.86
		United States to LME#7. Northeast U.S. Continental Shelf		1.17		39.19		13.88		82.86
		United States to LME#10. Insular Pacific-Hawaiian		1.17		39.19		13.88		82.86
		United States to LME#54. Chukchi Sea		7.41		249.05		88.17		526.54
		United States to LME#55. Beaufort Sea		7.41		249.05		88.17		526.54
858	Uruguay	Uruguay to LME#14. Patagonian Shelf	32.38	32.38	39.19	39.19	13.88	13.88	82.86	82.86
862	Venezuela (Bolivarian Republic of)	Venezuela (Bolivarian Republic of) to LME#12. Caribbean Sea	24.64	24.64	32.75	32.75	11.60	11.60	69.25	69.25
887	Yemen	Yemen to LME#32. Arabian Sea	189.09	189.09	307.51	307.51	108.87	108.87	650.13	650.13
894	Zambia	Zambia to LME#30. Agulhas Current	90.11	90.11	190.27	190.27	67.36	67.36	402.27	402.27
			n=143	n=214	n=143	n=214	n=143	n=214	n=143	n=214

### Appendix 3-X: Exposure

**Table 3.13:** Exposure Factors (XF) at the Country-to-LME scale.

ISO #	Country to LME	OM:N	O <sub>2</sub> :OM*(1-BGE)	O <sub>2</sub> :N	NIE	O <sub>2</sub> :N*NIE	*VCC = XF
		15.855	0.919	14.565	[-]	kgO <sub>2</sub> /kgN	kgO <sub>2</sub> /kgN
8	Albania to LME#26. Mediterranean				0.627	9.132	0.091
12	Algeria to LME#26. Mediterranean				0.627	9.132	0.091
24	Angola to LME#29. Benguela Current				2.734	39.821	0.398
32	Argentina to LME#14. Patagonian Shelf				2.754	40.111	0.401
36	Australia to LME#39. North Australia				1.584	23.067	0.231
	Australia to LME#40. Northeast Australia				0.495	7.204	0.072
	Australia to LME#41. East-Central Australia				0.625	9.105	0.091
	Australia to LME#42. Southeast Australia				0.777	11.317	0.113
	Australia to LME#43. Southwest Australia				0.745	10.844	0.108
	Australia to LME#44. West-Central Australia				0.709	10.322	0.103
	Australia to LME#45. Northwest Australia				0.771	11.233	0.112
40	Austria to LME#26. Mediterranean				0.627	9.132	0.091
44	Bahamas to LME#12. Caribbean Sea				0.712	10.376	0.104
50	Bangladesh to LME#34. Bay of Bengal				1.207	17.587	0.176
56	Belgium to LME#22. North Sea				2.075	30.230	0.302
64	Bhutan to LME#34. Bay of Bengal				1.207	17.587	0.176
68	Bolivia to LME#13. Humboldt Current				1.531	22.293	0.223
70	Bosnia and Herzegovina to LME#26. Mediterranean				0.627	9.132	0.091
72	Botswana to LME#30. Agulhas Current				0.959	13.971	0.140
76	Brazil to LME#15. South Brazil Shelf				1.311	19.099	0.191
	Brazil to LME#16. East Brazil Shelf				0.493	7.178	0.072
	Brazil to LME#17. North Brazil Shelf				2.304	33.552	0.336
84	Belize to LME#12. Caribbean Sea				0.712	10.376	0.104
92	Virgin Islands (British) to LME#12. Caribbean Sea				0.712	10.376	0.104
100	Bulgaria to LME#26. Mediterranean				0.627	9.132	0.091
	Bulgaria to LME#62. Black Sea				1.880	27.384	0.274
104	Myanmar to LME#34. Bay of Bengal				1.207	17.587	0.176
112	Belarus to LME#23. Baltic Sea				4.095	59.640	0.596
116	Cambodia to LME#3. California Current				0.975	14.205	0.142
120	Cameroon to LME#28. Guinea Current				1.763	25.685	0.257
124	Canada to LME#2. Gulf of Alaska				1.597	23.261	0.233
	Canada to LME#63. Hudson Bay				0.601	8.760	0.088
	Canada to LME#9. Newfoundland-Labrador Shelf				1.384	20.162	0.202
	Canada to LME#8. Scotian Shelf				2.754	40.111	0.401
	Canada to LME#64. Arctic Ocean				0.015	0.225	0.002
144	Sri Lanka to LME#34. Bay of Bengal				1.207	17.587	0.176
152	Chile to LME#13. Humboldt Current				1.531	22.293	0.223
156	China, People's Republic of to LME#36. South China Sea				0.711	10.349	0.103
	China, People's Republic of to LME#47. East China Sea				1.564	22.776	0.228
	China, People's Republic of to LME#48. Yellow Sea				3.308	48.181	0.482
170	Colombia to LME#11. Pacific Central-American				1.087	15.832	0.158
	Colombia to LME#12. Caribbean Sea				0.712	10.376	0.104
178	Congo to LME#28. Guinea Current				1.763	25.685	0.257
180	Democratic Republic of the Congo to LME#28. Guinea Current				1.763	25.685	0.257
188	Costa Rica to LME#11. Pacific Central-American				1.087	15.832	0.158
	Costa Rica to LME#12. Caribbean Sea				0.712	10.376	0.104
191	Croatia to LME#26. Mediterranean				0.627	9.132	0.091
192	Cuba to LME#12. Caribbean Sea				0.712	10.376	0.104
196	Cyprus to LME#26. Mediterranean				0.627	9.132	0.091

203	Czech Republic to LME#22. North Sea	2.075	30.230	0.302
204	Benin to LME#28. Guinea Current	1.763	25.685	0.257
208	Denmark to LME#22. North Sea	2.075	30.230	0.302
	Denmark to LME#23. Baltic Sea	4.095	59.640	0.596
	Denmark to LME#60. Faroe Plateau	0.609	8.866	0.089
214	Dominican Republic to LME#12. Caribbean Sea	0.712	10.376	0.104
218	Ecuador to LME#11. Pacific Central-American	1.087	15.832	0.158
222	El Salvador to LME#11. Pacific Central-American	1.087	15.832	0.158
226	Equatorial Guinea to LME#28. Guinea Current	1.763	25.685	0.257
231	Ethiopia to LME#32. Arabian Sea	1.968	28.664	0.287
	Ethiopia to LME#33. Red Sea	1.402	20.414	0.204
232	Eritrea to LME#33. Red Sea	1.402	20.414	0.204
233	Estonia to LME#23. Baltic Sea	4.095	59.640	0.596
238	Falkland Islands (Malvinas) to LME#14. Patagonian Shelf	2.754	40.111	0.401
246	Finland to LME#23. Baltic Sea	4.095	59.640	0.596
250	France to LME#22. North Sea	2.075	30.230	0.302
	France to LME#24. Celtic-Biscay Shelf	1.709	24.893	0.249
	France to LME#26. Mediterranean	0.627	9.132	0.091
262	Djibouti to LME#32. Arabian Sea	1.968	28.664	0.287
266	Gabon to LME#28. Guinea Current	1.763	25.685	0.257
268	Georgia to LME#62. Black Sea	1.880	27.384	0.274
270	Gambia to LME#28. Guinea Current	1.763	25.685	0.257
276	Germany to LME#22. North Sea	2.075	30.230	0.302
	Germany to LME#23. Baltic Sea	4.095	59.640	0.596
288	Ghana to LME#28. Guinea Current	1.763	25.685	0.257
300	Greece to LME#26. Mediterranean	0.627	9.132	0.091
320	Guatemala to LME#11. Pacific Central-American	1.087	15.832	0.158
	Guatemala to LME#12. Caribbean Sea	0.712	10.376	0.104
324	Guinea to LME#28. Guinea Current	1.763	25.685	0.257
328	Guyana to LME#17. North Brazil Shelf	2.304	33.552	0.336
332	Haiti to LME#12. Caribbean Sea	0.712	10.376	0.104
340	Honduras to LME#12. Caribbean Sea	0.712	10.376	0.104
348	Hungary to LME#62. Black Sea	1.880	27.384	0.274
352	Iceland to LME#59. Iceland Shelf	0.852	12.416	0.124
356	India to LME#32. Arabian Sea	1.968	28.664	0.287
	India to LME#34. Bay of Bengal	1.207	17.587	0.176
360	Indonesia to LME#38. Indonesian Sea	1.199	17.465	0.175
364	Iran, Islamic Republic of to LME#32. Arabian Sea	1.968	28.664	0.287
368	Iraq to LME#32. Arabian Sea	1.968	28.664	0.287
372	Ireland to LME#24. Celtic-Biscay Shelf	1.709	24.893	0.249
376	Israel to LME#26. Mediterranean	0.627	9.132	0.091
380	Italy to LME#26. Mediterranean	0.627	9.132	0.091
381	Kosovo to LME#26. Mediterranean	0.627	9.132	0.091
384	Côte d'Ivoire to LME#28. Guinea Current	1.763	25.685	0.257
388	Jamaica to LME#12. Caribbean Sea	0.712	10.376	0.104
392	Japan to LME#47. East China Sea	1.564	22.776	0.228
	Japan to LME#49. Kuroshio Current	0.609	8.866	0.089
	Japan to LME#50. Sea of Japan/East Sea	0.957	13.942	0.139
	Japan to LME#51. Oyashio Current	1.186	17.282	0.173
	Japan to LME#52. Sea of Okhotsk	1.397	20.351	0.204
400	Jordan to LME#33. Red Sea	1.402	20.414	0.204
404	Kenya to LME#31. Somali Coastal Current	1.118	16.282	0.163
408	Democratic People's Republic of Korea to LME#47. East China Sea	1.564	22.776	0.228
	Democratic People's Republic of Korea to LME#48. Yellow Sea	3.308	48.181	0.482
	Democratic People's Republic of Korea to LME#50. Sea of Japan/East Sea	0.957	13.942	0.139

410	Republic of Korea to LME#47. East China Sea	1.564	22.776	0.228
	Republic of Korea to LME#48. Yellow Sea	3.308	48.181	0.482
	Republic of Korea to LME#50. Sea of Japan/East Sea	0.957	13.942	0.139
418	Lao People's Democratic Republic to LME#36. South China Sea	0.711	10.349	0.103
422	Lebanon to LME#26. Mediterranean	0.627	9.132	0.091
428	Latvia to LME#23. Baltic Sea	4.095	59.640	0.596
430	Liberia to LME#28. Guinea Current	1.763	25.685	0.257
434	Libyan Arab Jamahiriya to LME#26. Mediterranean	0.627	9.132	0.091
440	Lithuania to LME#23. Baltic Sea	4.095	59.640	0.596
450	Madagascar to LME#30. Agulhas Current	0.959	13.971	0.140
458	Malaysia to LME#34. Bay of Bengal	1.207	17.587	0.176
	Malaysia to LME#35. Gulf of Thailand	1.322	19.254	0.193
	Malaysia to LME#36. South China Sea	0.711	10.349	0.103
466	Mali to LME#27. Canary Current	2.268	33.028	0.330
	Mali to LME#28. Guinea Current	1.763	25.685	0.257
478	Mauritania to LME#27. Canary Current	2.268	33.028	0.330
484	Mexico to LME#3. California Current	0.975	14.205	0.142
	Mexico to LME#4. Gulf of California	2.275	33.133	0.331
	Mexico to LME#5. Gulf of Mexico	0.890	12.959	0.130
498	Moldova to LME#62. Black Sea	1.880	27.384	0.274
499	Montenegro to LME#26. Mediterranean	0.627	9.132	0.091
504	Morocco to LME#26. Mediterranean	0.627	9.132	0.091
	Morocco to LME#27. Canary Current	2.268	33.028	0.330
508	Mozambique to LME#30. Agulhas Current	0.959	13.971	0.140
512	Oman to LME#32. Arabian Sea	1.968	28.664	0.287
516	Namibia to LME#29. Benguela Current	2.734	39.821	0.398
524	Nepal to LME#34. Bay of Bengal	1.207	17.587	0.176
528	Netherlands to LME#22. North Sea	2.075	30.230	0.302
540	New Caledonia to LME#40. Northeast Australia	0.495	7.204	0.072
554	New Zealand to LME#46. New Zealand Shelf	0.890	12.959	0.130
558	Nicaragua to LME#11. Pacific Central-American	1.087	15.832	0.158
	Nicaragua to LME#12. Caribbean Sea	0.712	10.376	0.104
562	Niger to LME#28. Guinea Current	1.763	25.685	0.257
566	Nigeria to LME#28. Guinea Current	1.763	25.685	0.257
578	Norway to LME#21. Norwegian Sea	0.737	10.734	0.107
	Norway to LME#22. North Sea	2.075	30.230	0.302
586	Pakistan to LME#32. Arabian Sea	1.968	28.664	0.287
591	Panama to LME#11. Pacific Central-American	1.087	15.832	0.158
	Panama to LME#12. Caribbean Sea	0.712	10.376	0.104
600	Paraguay to LME#14. Patagonian Shelf	2.754	40.111	0.401
604	Peru to LME#13. Humboldt Current	1.531	22.293	0.223
608	Philippines to LME#36. South China Sea	0.711	10.349	0.103
	Philippines to LME#37. Sulu-Celebes Sea	0.896	13.045	0.130
616	Poland to LME#23. Baltic Sea	4.095	59.640	0.596
620	Portugal to LME#25. Iberian Coastal	1.275	18.571	0.186
624	Guinea-Bissau to LME#28. Guinea Current	1.763	25.685	0.257
626	Timor-Leste to LME#38. Indonesian Sea	1.199	17.465	0.175
630	Puerto Rico to LME#12. Caribbean Sea	0.712	10.376	0.104
642	Romania to LME#62. Black Sea	1.880	27.384	0.274
643	Russian Federation to LME#20. Barents Sea	0.594	8.654	0.087
	Russian Federation to LME#54. Chukchi Sea	0.313	4.555	0.046
	Russian Federation to LME#56. East Siberian Sea	0.164	2.382	0.024
	Russian Federation to LME#57. Laptev Sea	0.621	9.052	0.091
	Russian Federation to LME#58. Kara Sea	0.475	6.925	0.069
	Russian Federation to LME#62. Black Sea	1.880	27.384	0.274

	Russian Federation to LME#64. Arctic Ocean	0.015	0.225	0.002
	Russian Federation to LME#50. Sea of Japan/East Sea	0.957	13.942	0.139
	Russian Federation to LME#51. Oyashio Current	1.186	17.282	0.173
	Russian Federation to LME#52. Sea of Okhotsk	1.397	20.351	0.204
	Russian Federation to LME#53. West Bering Sea	0.921	13.419	0.134
682	Saudi Arabia to LME#32. Arabian Sea	1.968	28.664	0.287
	Saudi Arabia to LME#33. Red Sea	1.402	20.414	0.204
686	Senegal to LME#27. Canary Current	2.268	33.028	0.330
688	Serbia to LME#62. Black Sea	1.880	27.384	0.274
	Serbia to LME#26. Mediterranean	0.627	9.132	0.091
694	Sierra Leone to LME#28. Guinea Current	1.763	25.685	0.257
703	Slovakia to LME#62. Black Sea	1.880	27.384	0.274
704	Viet Nam to LME#36. South China Sea	0.711	10.349	0.103
705	Slovenia to LME#26. Mediterranean	0.627	9.132	0.091
706	Somalia to LME#31. Somali Coastal Current	1.118	16.282	0.163
	Somalia to LME#32. Arabian Sea	1.968	28.664	0.287
710	South Africa to LME#29. Benguela Current	2.734	39.821	0.398
	South Africa to LME#30. Agulhas Current	0.959	13.971	0.140
716	Zimbabwe to LME#30. Agulhas Current	0.959	13.971	0.140
724	Spain to LME#25. Iberian Coastal	1.275	18.571	0.186
	Spain to LME#26. Mediterranean	0.627	9.132	0.091
736	Sudan to LME#33. Red Sea	1.402	20.414	0.204
748	Swaziland to LME#30. Agulhas Current	0.959	13.971	0.140
752	Sweden to LME#23. Baltic Sea	4.095	59.640	0.596
	Sweden to LME#22. North Sea	2.075	30.230	0.302
756	Switzerland to LME#22. North Sea	2.075	30.230	0.302
	Switzerland to LME#26. Mediterranean	0.627	9.132	0.091
	Switzerland to LME#62. Black Sea	1.880	27.384	0.274
760	Syrian Arab Republic to LME#26. Mediterranean	0.627	9.132	0.091
764	Thailand to LME#34. Bay of Bengal	1.207	17.587	0.176
768	Togo to LME#28. Guinea Current	1.763	25.685	0.257
784	United Arab Emirates to LME#32. Arabian Sea	1.968	28.664	0.287
788	Tunisia to LME#26. Mediterranean	0.627	9.132	0.091
792	Turkey to LME#26. Mediterranean	0.627	9.132	0.091
800	Uganda to LME#26. Mediterranean	0.627	9.132	0.091
804	Ukraine to LME#62. Black Sea	1.880	27.384	0.274
807	The FYR of Macedonia to LME#26. Mediterranean	0.627	9.132	0.091
818	Egypt to LME#26. Mediterranean	0.627	9.132	0.091
826	United Kingdom of GB and NI to LME#22. North Sea	2.075	30.230	0.302
	United Kingdom of GB and NI to LME#24. Celtic-Biscay Shelf	1.709	24.893	0.249
834	United Republic of Tanzania: Mainland to LME#30. Agulhas Current	0.959	13.971	0.140
840	United States to LME#1. East Bering Sea	1.326	19.317	0.193
	United States to LME#2. Gulf of Alaska	1.597	23.261	0.233
	United States to LME#3. California Current	0.975	14.205	0.142
	United States to LME#4. Gulf of California	2.275	33.133	0.331
	United States to LME#5. Gulf of Mexico	0.890	12.959	0.130
	United States to LME#6. Southeast U.S. Continental Shelf	1.197	17.434	0.174
	United States to LME#7. Northeast U.S. Continental Shelf	3.110	45.296	0.453
	United States to LME#10. Insular Pacific-Hawaiian	0.286	4.166	0.042
	United States to LME#54. Chukchi Sea	0.313	4.555	0.046
	United States to LME#55. Beaufort Sea	0.439	6.401	0.064
858	Uruguay to LME#14. Patagonian Shelf	2.754	40.111	0.401
862	Venezuela (Bolivarian Republic of) to LME#12. Caribbean Sea	0.712	10.376	0.104
887	Yemen to LME#32. Arabian Sea	1.968	28.664	0.287
894	Zambia to LME#30. Agulhas Current	0.959	13.971	0.140

**Appendix 3-XI: Effect**

**Table 3.14:** Effect Factors (EF) per LME based on the results per climate zone.

LME			LME		
#. name	#	PAF.m <sup>3</sup> /kgO <sub>2</sub>	#. name	#	PAF.m <sup>3</sup> /kgO <sub>2</sub>
1. East Bering Sea	1	3.10E+02	33. Red Sea	33	3.42E+02
2. Gulf of Alaska	2	3.68E+02	34. Bay of Bengal	34	3.42E+02
3. California Current	3	2.96E+02	35. Gulf of Thailand	35	3.42E+02
4. Gulf of California	4	2.96E+02	36. South China Sea	36	3.42E+02
5. Gulf of Mexico	5	2.96E+02	37. Sulu-Celebes Sea	37	3.42E+02
6. Southeast U.S. Continental Shelf	6	2.96E+02	38. Indonesian Sea	38	3.42E+02
7. Northeast U.S. Continental Shelf	7	3.68E+02	39. North Australia	39	3.42E+02
8. Scotian Shelf	8	3.68E+02	40. Northeast Australia	40	3.42E+02
9. Newfoundland-Labrador Shelf	9	3.10E+02	41. East-Central Australia	41	2.96E+02
10. Insular Pacific-Hawaiian	10	3.42E+02	42. Southeast Australia	42	3.68E+02
11. Pacific Central-American	11	3.42E+02	43. Southwest Australia	43	3.68E+02
12. Caribbean Sea	12	3.42E+02	44. West-Central Australia	44	2.96E+02
13. Humboldt Current	13	3.68E+02	45. Northwest Australia	45	3.42E+02
14. Patagonian Shelf	14	3.68E+02	46. New Zealand Shelf	46	3.68E+02
15. South Brazil Shelf	15	2.96E+02	47. East China Sea	47	2.96E+02
16. East Brazil Shelf	16	3.42E+02	48. Yellow Sea	48	3.68E+02
17. North Brazil Shelf	17	3.42E+02	49. Kuroshio Current	49	2.96E+02
18. West Greenland Shelf	18	3.01E+02	50. Sea of Japan/East Sea	50	3.68E+02
19. East Greenland Shelf	19	3.01E+02	51. Oyashio Current	51	3.68E+02
20. Barents Sea	20	3.01E+02	52. Sea of Okhotsk	52	3.10E+02
21. Norwegian Sea	21	3.10E+02	53. West Bering Sea	53	3.10E+02
22. North Sea	22	3.68E+02	54. Chukchi Sea	54	3.01E+02
23. Baltic Sea	23	3.10E+02	55. Beaufort Sea	55	3.01E+02
24. Celtic-Biscay Shelf	24	3.68E+02	56. East Siberian Sea	56	3.01E+02
25. Iberian Coastal	25	3.68E+02	57. Laptev Sea	57	3.01E+02
26. Mediterranean	26	2.96E+02	58. Kara Sea	58	3.01E+02
27. Canary Current	27	2.96E+02	59. Iceland Shelf	59	3.10E+02
28. Guinea Current	28	3.42E+02	60. Faroe Plateau	60	3.68E+02
29. Benguela Current	29	2.96E+02	61. Antarctic	61	3.01E+02
30. Agulhas Current	30	2.96E+02	62. Black Sea	62	3.68E+02
31. Somali Coastal Current	31	3.42E+02	63. Hudson Bay	63	3.01E+02
32. Arabian Sea	32	3.42E+02	64. Arctic Ocean	64	3.01E+02



**Appendix 3-XII: Characterisation Factors**

**Table 3.15: Characterisation Factors (CF) per emission route at the Country-to-LME and Country scales.**

ISO#	Country	Country-to-LME	emission route:		N to Air		N to sfw		N to gw		N to mw	
			spatial scale:		Country	Country-to-LME	Country	Country-to-LME	Country	Country-to-LME	Country	Country-to-LME
			unit:	PAF.m <sup>3</sup> .d/kgN	PAF.m <sup>3</sup> .d/kgN	PAF.m <sup>3</sup> .d/kgN	PAF.m <sup>3</sup> .d/kgN	PAF.m <sup>3</sup> .d/kgN	PAF.m <sup>3</sup> .d/kgN	PAF.m <sup>3</sup> .d/kgN	PAF.m <sup>3</sup> .d/kgN	PAF.m <sup>3</sup> .d/kgN
8	Albania	Albania to LME#26. Mediterranean	7,606.07	7,606.07	11,128.87	11,128.87	3,940.04	3,940.04	23,528.27	23,528.27	23,528.27	23,528.27
13	Algeria	Algeria to LME#26. Mediterranean	7,211.38	7,211.38	11,128.87	11,128.87	3,940.04	3,940.04	23,528.27	23,528.27	23,528.27	23,528.27
24	Angola	Angola to LME#29. Benguela Current	2,490.13	2,490.13	4,613.74	4,613.74	1,633.44	1,633.44	9,754.22	9,754.22	9,754.22	9,754.22
33	Argentina	Argentina to LME#14. Patagonian Shelf	4,416.45	4,416.45	5,793.14	5,793.14	2,050.99	2,050.99	12,247.66	12,247.66	12,247.66	12,247.66
36	Australia	Australia to LME#39. North Australia	550.68	154.64	11,019.20	3,094.40	3,901.21	1,095.53	23,296.40	6,542.07	23,296.40	6,542.07
		Australia to LME#40. Northeast Australia		48.29		966.37		342.13			2,043.07	
		Australia to LME#41. East-Central Australia		52.72		1,054.97		373.50			2,230.37	
		Australia to LME#42. Southeast Australia		81.68		1,634.43		578.65			3,455.46	
		Australia to LME#43. Southwest Australia		78.27		1,566.22		554.50			3,311.26	
		Australia to LME#44. West-Central Australia		59.76		1,195.88		423.39			2,528.28	
		Australia to LME#45. Northwest Australia		75.31		1,506.92		533.51			3,185.88	
40	Austria	Austria to LME#26. Mediterranean	5,986.51	5,986.51	11,128.87	11,128.87	3,940.04	3,940.04	23,528.27	23,528.27	23,528.27	23,528.27
44	Bahamas	Bahamas to LME#12. Caribbean Sea	1,490.85	1,490.85	1,163.28	1,163.28	411.84	411.84	2,459.37	2,459.37	2,459.37	2,459.37
50	Bangladesh	Bangladesh to LME#34. Bay of Bengal	11,107.20	11,107.20	21,167.69	21,167.69	7,494.15	7,494.15	44,752.00	44,752.00	44,752.00	44,752.00
56	Belgium	Belgium to LME#22. North Sea	14,146.99	14,146.99	21,195.67	21,195.67	7,504.06	7,504.06	44,811.14	44,811.14	44,811.14	44,811.14
64	Bhutan	Bhutan to LME#34. Bay of Bengal	9,743.61	9,743.61	21,167.69	21,167.69	7,494.15	7,494.15	44,752.00	44,752.00	44,752.00	44,752.00
68	Bolivia	Bolivia to LME#13. Humboldt Current	214.72	214.72	422.52	422.52	149.59	149.59	893.27	893.27	893.27	893.27
71	Bosnia and Herzegovina	Bosnia and Herzegovina to LME#26. Mediterranean	6,433.01	6,433.01	11,128.87	11,128.87	3,940.04	3,940.04	23,528.27	23,528.27	23,528.27	23,528.27
73	Botswana	Botswana to LME#30. Agulhas Current	4,689.03	4,689.03	7,858.44	7,858.44	2,782.18	2,782.18	16,614.04	16,614.04	16,614.04	16,614.04
76	Brazil	Brazil to LME#15. South Brazil Shelf	974.66	280.94	7,676.74	2,212.79	2,717.85	783.41	16,229.90	4,678.20	16,229.90	4,678.20
		Brazil to LME#16. East Brazil Shelf		122.26		962.97		340.93			2,035.87	
		Brazil to LME#17. North Brazil Shelf		571.46		4,500.99		1,593.52			9,515.83	
84	Belize	Belize to LME#12. Caribbean Sea	1,097.00	1,097.00	1,163.28	1,163.28	411.84	411.84	2,459.37	2,459.37	2,459.37	2,459.37
92	Virgin Islands (British)	Virgin Islands (British) to LME#12. Caribbean Sea	1,692.38	1,692.38	1,163.28	1,163.28	411.84	411.84	2,459.37	2,459.37	2,459.37	2,459.37
100	Bulgaria	Bulgaria to LME#26. Mediterranean	11,041.33	2,330.43	52,727.40	11,128.87	18,667.47	3,940.04	111,474.42	23,528.27	111,474.42	23,528.27
		Bulgaria to LME#62. Black Sea		8,710.90		41,598.53		14,727.43			87,946.16	
104	Myanmar	Myanmar to LME#34. Bay of Bengal	12,033.02	12,033.02	21,167.69	21,167.69	7,494.15	7,494.15	44,752.00	44,752.00	44,752.00	44,752.00
113	Belarus	Belarus to LME#23. Baltic Sea	29,863.38	29,863.38	71,378.35	71,378.35	25,270.60	25,270.60	150,905.61	150,905.61	150,905.61	150,905.61
116	Cambodia	Cambodia to LME#3. California Current	1,187.57	1,187.57	1,645.78	1,645.78	582.67	582.67	3,479.44	3,479.44	3,479.44	3,479.44
120	Cameroon	Cameroon to LME#28. Guinea Current	10,509.35	10,509.35	20,790.05	20,790.05	7,360.45	7,360.45	43,953.59	43,953.59	43,953.59	43,953.59
124	Canada	Canada to LME#2. Gulf of Alaska	1,974.47	216.39	30,654.26	3,359.50	10,852.75	1,189.39	64,808.16	7,102.53	64,808.16	7,102.53
		Canada to LME#63. Hudson Bay		524.41		8,141.68		2,882.46			17,212.84	
		Canada to LME#9. Newfoundland-Labrador Shelf		157.96		2,452.32		868.21			5,184.60	
		Canada to LME#8. Scotian Shelf		1,060.60		16,466.06		5,829.60			34,811.98	
		Canada to LME#4. Arctic Ocean		15.12		234.71		83.09			496.21	
144	Sri Lanka	Sri Lanka to LME#34. Bay of Bengal	25,932.46	25,932.46	21,167.69	21,167.69	7,494.15	7,494.15	44,752.00	44,752.00	44,752.00	44,752.00
152	Chile	Chile to LME#13. Humboldt Current	369.57	369.57	422.52	422.52	149.59	149.59	893.27	893.27	893.27	893.27
156	China, People's Republic of	China, People's Republic of to LME#36. South China Sea	7,937.94	1,810.54	59,893.59	13,660.98	21,204.56	4,836.50	126,624.94	28,881.56	126,624.94	28,881.56
		China, People's Republic of to LME#47. East China Sea		1,650.06		12,450.11		4,407.80			26,321.58	
		China, People's Republic of to LME#48. Yellow Sea		4,477.33		33,782.51		11,960.27			71,421.80	
170	Colombia	Colombia to LME#11. Pacific Central-American	809.98	523.34	3,287.18	2,123.90	1,163.78	751.94	6,949.63	4,490.26	6,949.63	4,490.26
		Colombia to LME#12. Caribbean Sea		286.64		1,163.28		411.84			2,459.37	
178	Congo	Congo to LME#28. Guinea Current	10,781.75	10,781.75	20,790.05	20,790.05	7,360.45	7,360.45	43,953.59	43,953.59	43,953.59	43,953.59
180	Democratic Republic of the Congo	Democratic Republic of the Congo to LME#28. Guinea Current	8,817.57	8,817.57	20,790.05	20,790.05	7,360.45	7,360.45	43,953.59	43,953.59	43,953.59	43,953.59
188	Costa Rica	Costa Rica to LME#11. Pacific Central-American	1,152.00	744.33	3,287.18	2,123.90	1,163.78	751.94	6,949.63	4,490.26	6,949.63	4,490.26
		Costa Rica to LME#12. Caribbean Sea		407.68		1,163.28		411.84			2,459.37	
191	Croatia	Croatia to LME#26. Mediterranean	6,318.80	6,318.80	11,128.87	11,128.87	3,940.04	3,940.04	23,528.27	23,528.27	23,528.27	23,528.27
192	Cuba	Cuba to LME#12. Caribbean Sea	1,445.79	1,445.79	1,163.28	1,163.28	411.84	411.84	2,459.37	2,459.37	2,459.37	2,459.37
196	Cyprus	Cyprus to LME#26. Mediterranean	8,841.96	8,841.96	11,128.87	11,128.87	3,940.04	3,940.04	23,528.27	23,528.27	23,528.27	23,528.27
203	Czech Republic	Czech Republic to LME#22. North Sea	10,857.65	10,857.65	21,195.67	21,195.67	7,504.06	7,504.06	44,811.14	44,811.14	44,811.14	44,811.14
204	Benin	Benin to LME#28. Guinea Current	13,077.95	13,077.95	20,790.05	20,790.05	7,360.45	7,360.45	43,953.59	43,953.59	43,953.59	43,953.59
208	Denmark	Denmark to LME#22. North Sea	13,803.73	3,117.37	93,854.51	21,195.67	33,227.99	7,504.06	198,423.91	44,811.14	198,423.91	44,811.14
		Denmark to LME#23. Baltic Sea		10,498.03		71,378.35		25,270.60			150,905.61	
		Denmark to LME#60. Faroe Plateau		188.33		1,280.49		453.34			2,707.16	
214	Dominican Republic	Dominican Republic to LME#12. Caribbean Sea	1,545.87	1,545.87	1,163.28	1,163.28	411.84	411.84	2,459.37	2,459.37	2,459.37	2,459.37
218	Ecuador	Ecuador to LME#11. Pacific Central-American	1,521.96	1,521.96	2,123.90	2,123.90	751.94	751.94	4,490.26	4,490.26	4,490.26	4,490.26
221	El Salvador	El Salvador to LME#11. Pacific Central-American	2,097.28	2,097.28	2,123.90	2,123.90	751.94	751.94	4,490.26	4,490.26	4,490.26	4,490.26
226	Equatorial Guinea	Equatorial Guinea to LME#28. Guinea Current	14,004.93	14,004.93	20,790.05	20,790.05	7,360.45	7,360.45	43,953.59	43,953.59	43,953.59	43,953.59
231	Ethiopia	Ethiopia to LME#32. Arabian Sea	11,144.71	5,792.04	58,050.86	30,169.71	20,552.17	10,681.20	122,729.09	63,783.75	122,729.09	63,783.75
		Ethiopia to LME#33. Red Sea		5,352.68		27,881.15		9,870.96			58,945.34	
232	Eritrea	Eritrea to LME#33. Red Sea	15,412.99	15,412.99	27,881.15	27,881.15	9,870.96	9,870.96	58,945.34	58,945.34	58,945.34	58,945.34
233	Estonia	Estonia to LME#23. Baltic Sea	38,535.67	38,535.67	71,378.35	71,378.35	25,270.60	25,270.60	150,905.61	150,905.61	150,905.61	150,905.61
238	Falkland Islands (Malvinas)	Falkland Islands (Malvinas) to LME#14. Patagonian Shelf	9,187.22	9,187.22	5,793.14	5,793.14	2,050.99	2,050.99	12,247.66	12,247.66	12,247.66	12,247.66
248	Finland	Finland to LME#23. Baltic Sea	38,643.28	38,643.28	71,378.35	71,378.35	25,270.60	25,270.60	150,905.61	150,905.61	150,905.61	150,905.61
250	France	France to LME#22. North Sea	6,843.27	2,913.86	49,778.52	21,195.67	17,623.45	7,504.06	105,240.00	44,811.14	105,240.00	44,811.14
		France to LME#24. Celtic-Biscay Shelf		2,399.47		17,453.98		6,179.36			36,900.59	
		France to LME#26. Mediterranean		1,529.93		11,128.87		3,940.04			23,528.27	
262	Djibouti	Djibouti to LME#32. Arabian Sea	18,417.86	18,417.86	30,169.71	30,169.71	10,681.20	10,681.20	63,783.75	63,783.75	63,783.75	63,783.75
266	Gabon	Gabon to LME#28. Guinea Current	13,043.97	13,043.97	20,790.05	20,790.05	7,360.45	7,360.45	43,953.59	43,953.59	43,953.59	43,953.59
268	Georgia	Georgia to LME#62. Black Sea	17,264.22	17,264.22	41,598.53	41,598.53	14,727.43	14,727.43	87,946.16	87,946.16	87,946.16	87,946.16
270	Gambia	Gambia to LME#28. Guinea Current	19,658.43	19,658.43	20,790.05	20,790.05	7,360.45	7,360.45	43,953.59	43,953.59	43,953.59	4



368	Iraq	Iraq to LME#32. Arabian Sea	12,920.81	12,920.81	30,169.71	30,169.71	10,681.20	10,681.20	63,783.75	63,783.75
372	Ireland	Ireland to LME#24. Celtic-Biscay Shelf	17,768.49	17,768.49	17,453.98	17,453.98	6,179.36	6,179.36	36,900.59	36,900.59
376	Israel	Israel to LME#26. Mediterranean	6,128.33	6,128.33	11,128.87	11,128.87	3,940.04	3,940.04	23,528.27	23,528.27
380	Italy	Italy to LME#26. Mediterranean	7,754.52	7,754.52	11,128.87	11,128.87	3,940.04	3,940.04	23,528.27	23,528.27
381	Kosovo	Kosovo to LME#26. Mediterranean	6,004.91	6,004.91	11,128.87	11,128.87	3,940.04	3,940.04	23,528.27	23,528.27
384	Côte d'Ivoire	Côte d'Ivoire to LME#28. Guinea Current	15,667.52	15,667.52	20,790.05	20,790.05	7,360.45	7,360.45	43,953.59	43,953.59
388	Jamaica	Jamaica to LME#12. Caribbean Sea	1,571.02	1,571.02	1,163.28	1,163.28	411.84	411.84	2,459.37	2,459.37
392	Japan	Japan to LME#47. East China Sea	4,767.33	1,138.15	52,149.38	12,450.11	18,462.82	4,407.80	110,252.38	26,321.58
5		Japan to LME#49. Kuroshio Current		491.17		5,372.88		1,902.20		11,359.16
		Japan to LME#50. Sea of Japan/East Sea		1,811.28		19,813.46		7,014.70		41,888.91
		Japan to LME#51. Oyashio Current		228.17		2,495.94		883.65		5,276.82
		Japan to LME#52. Sea of Okhotsk		1,098.56		12,016.99		4,254.46		25,405.91
400	Jordan	Jordan to LME#33. Red Sea	13,339.20	13,339.20	27,881.15	27,881.15	9,870.96	9,870.96	58,945.34	58,945.34
404	Kenya	Kenya to LME#31. Somali Coastal Current	1,162.60	1,162.60	2,184.28	2,184.28	773.32	773.32	4,617.93	4,617.93
408	Democratic People's Republic of Korea	Democratic People's Republic of Korea to LME#47. East China Sea	10,340.12	1,949.18	66,046.07	12,450.11	23,382.77	4,407.80	139,632.29	26,321.58
3		Democratic People's Republic of Korea to LME#48. Yellow Sea		5,288.96		33,782.51		11,960.27		71,421.80
		Democratic People's Republic of Korea to LME#50. Sea of Japan/East Sea		3,101.98		19,813.46		7,014.70		41,888.91
410	Republic of Korea	Republic of Korea to LME#47. East China Sea	11,305.84	2,131.22	66,046.07	12,450.11	23,382.77	4,407.80	139,632.29	26,321.58
3		Republic of Korea to LME#48. Yellow Sea		5,782.93		33,782.51		11,960.27		71,421.80
		Republic of Korea to LME#50. Sea of Japan/East Sea		3,391.69		19,813.46		7,014.70		41,888.91
418	Lao People's Democratic Republic	Lao People's Democratic Republic to LME#36. South China Sea	9,051.71	9,051.71	13,660.98	13,660.98	4,836.50	4,836.50	28,881.56	28,881.56
422	Lebanon	Lebanon to LME#26. Mediterranean	6,439.34	6,439.34	11,128.87	11,128.87	3,940.04	3,940.04	23,528.27	23,528.27
428	Latvia	Latvia to LME#23. Baltic Sea	35,828.36	35,828.36	71,378.35	71,378.35	25,270.60	25,270.60	150,905.61	150,905.61
430	Liberia	Liberia to LME#28. Guinea Current	18,505.35	18,505.35	20,790.05	20,790.05	7,360.45	7,360.45	43,953.59	43,953.59
434	Libyan Arab Jamahiriya	Libyan Arab Jamahiriya to LME#26. Mediterranean	6,311.36	6,311.36	11,128.87	11,128.87	3,940.04	3,940.04	23,528.27	23,528.27
440	Lithuania	Lithuania to LME#23. Baltic Sea	33,510.99	33,510.99	71,378.35	71,378.35	25,270.60	25,270.60	150,905.61	150,905.61
450	Madagascar	Madagascar to LME#30. Agulhas Current	6,968.10	6,968.10	7,858.44	7,858.44	2,782.18	2,782.18	16,614.04	16,614.04
458	Malaysia	Malaysia to LME#34. Bay of Bengal	6,260.37	3,758.44	35,258.65	21,167.69	12,482.88	7,494.15	74,542.60	44,752.00
3		Malaysia to LME#35. Gulf of Thailand		76.35		429.98		152.23		909.05
		Malaysia to LME#36. South China Sea		2,425.58		13,660.98		4,836.50		28,881.56
466	Mali	Mali to LME#27. Canary Current	5,883.41	914.58	24,616.72	3,826.67	8,715.24	1,354.78	52,043.81	8,090.22
2		Mali to LME#28. Guinea Current		4,968.83		20,790.05		7,360.45		43,953.59
478	Mauritania	Mauritania to LME#27. Canary Current	2,965.74	2,965.74	3,826.67	3,826.67	1,354.78	1,354.78	8,090.22	8,090.22
484	Mexico	Mexico to LME#3. California Current	4,995.20	247.74	33,183.89	1,645.78	11,748.33	582.67	70,156.21	3,479.44
3		Mexico to LME#4. Gulf of California		2,370.27		15,746.08		5,574.70		33,289.80
		Mexico to LME#5. Gulf of Mexico		2,377.19		15,792.03		5,590.97		33,386.96
498	Moldova	Moldova to LME#62. Black Sea	19,732.66	19,732.66	41,598.53	41,598.53	14,727.43	14,727.43	87,946.16	87,946.16
490	Montenegro	Montenegro to LME#26. Mediterranean	6,004.91	6,004.91	11,128.87	11,128.87	3,940.04	3,940.04	23,528.27	23,528.27
504	Morocco	Morocco to LME#26. Mediterranean	3,853.37	2,867.41	14,955.54	11,128.87	5,294.82	3,940.04	31,618.48	23,528.27
2		Morocco to LME#27. Canary Current		985.96		3,826.67		1,354.78		8,090.22
508	Mozambique	Mozambique to LME#30. Agulhas Current	5,012.94	5,012.94	7,858.44	7,858.44	2,782.18	2,782.18	16,614.04	16,614.04
512	Oman	Oman to LME#32. Arabian Sea	21,274.65	21,274.65	30,169.71	30,169.71	10,681.20	10,681.20	63,783.75	63,783.75
518	Namibia	Namibia to LME#29. Benguela Current	3,124.29	3,124.29	4,613.74	4,613.74	1,633.44	1,633.44	9,754.22	9,754.22
524	Nepal	Nepal to LME#34. Bay of Bengal	9,178.18	9,178.18	21,167.69	21,167.69	7,494.15	7,494.15	44,752.00	44,752.00
528	Netherlands	Netherlands to LME#22. North Sea	14,615.34	14,615.34	21,195.67	21,195.67	7,504.06	7,504.06	44,811.14	44,811.14
540	New Caledonia	New Caledonia to LME#40. Northeast Australia	1,692.66	1,692.66	966.37	966.37	342.13	342.13	2,043.07	2,043.07
554	New Zealand	New Zealand to LME#46. New Zealand Shelf	2,518.46	2,518.46	1,871.56	1,871.56	662.60	662.60	3,956.78	3,956.78
558	Nicaragua	Nicaragua to LME#11. Pacific Central-American	1,070.72	691.81	3,287.18	2,123.90	1,163.78	751.94	6,949.63	4,490.26
2		Nicaragua to LME#12. Caribbean Sea		378.91		1,163.28		411.84		2,459.37
562	Niger	Niger to LME#28. Guinea Current	10,873.93	10,873.93	20,790.05	20,790.05	7,360.45	7,360.45	43,953.59	43,953.59
566	Nigeria	Nigeria to LME#28. Guinea Current	11,375.19	11,375.19	20,790.05	20,790.05	7,360.45	7,360.45	43,953.59	43,953.59
578	Norway	Norway to LME#21. Norwegian Sea	6,640.38	1,528.58	27,533.82	6,338.15	9,748.00	2,243.94	58,211.03	13,399.88
2		Norway to LME#22. North Sea		5,111.80		21,195.67		7,504.06		44,811.14
586	Pakistan	Pakistan to LME#32. Arabian Sea	13,556.88	13,556.88	30,169.71	30,169.71	10,681.20	10,681.20	63,783.75	63,783.75
593	Panama	Panama to LME#11. Pacific Central-American	1,140.17	736.68	3,287.18	2,123.90	1,163.78	751.94	6,949.63	4,490.26
2		Panama to LME#12. Caribbean Sea		403.49		1,163.28		411.84		2,459.37
600	Paraguay	Paraguay to LME#14. Patagonian Shelf	3,331.12	3,331.12	5,793.14	5,793.14	2,050.99	2,050.99	12,247.66	12,247.66
604	Peru	Peru to LME#13. Humboldt Current	301.05	301.05	422.52	422.52	149.59	149.59	893.27	893.27
608	Philippines	Philippines to LME#36. South China Sea	11,523.83	5,097.96	30,880.38	13,660.98	10,932.80	4,836.50	65,286.21	28,881.56
2		Philippines to LME#37. Sulu-Celebes Sea		6,425.88		17,219.40		6,096.31		36,404.65
616	Poland	Poland to LME#23. Baltic Sea	35,107.62	35,107.62	71,378.35	71,378.35	25,270.60	25,270.60	150,905.61	150,905.61
620	Portugal	Portugal to LME#25. Iberian Coastal	2,497.74	2,497.74	2,682.17	2,682.17	949.59	949.59	5,670.55	5,670.55
624	Guinea-Bissau	Guinea-Bissau to LME#28. Guinea Current	18,512.85	18,512.85	20,790.05	20,790.05	7,360.45	7,360.45	43,953.59	43,953.59
626	Timor-Leste	Timor-Leste to LME#38. Indonesian Sea	8,710.92	8,710.92	5,930.87	5,930.87	2,099.75	2,099.75	12,538.84	12,538.84
630	Puerto Rico	Puerto Rico to LME#12. Caribbean Sea	1,612.49	1,612.49	1,163.28	1,163.28	411.84	411.84	2,459.37	2,459.37
642	Romania	Romania to LME#62. Black Sea	20,602.61	20,602.61	41,598.53	41,598.53	14,727.43	14,727.43	87,946.16	87,946.16
643	Russian Federation	Russian Federation to LME#20. Barents Sea	2,591.69	128.55	99,924.93	4,956.31	35,377.15	1,754.72	211,257.79	10,478.46
11		Russian Federation to LME#54. Chukchi Sea		88.56		3,414.44		1,208.84		7,218.69
		Russian Federation to LME#56. East Siberian Sea		46.31		1,785.58		632.16		3,775.00
		Russian Federation to LME#57. Laptev Sea		175.99		6,785.50		2,402.32		14,345.67
		Russian Federation to LME#58. Kara Sea		134.64		5,191.29		1,837.91		10,975.25
		Russian Federation to LME#62. Black Sea		1,078.91		41,598.53		14,727.43		87,946.16
		Russian Federation to LME#64. Arctic Ocean		6.09		234.71		83.09		496.21
		Russian Federation to LME#50. Sea of Japan/East Sea		513.89		19,813.46		7,014.70		41,888.91
		Russian Federation to LME#51. Oyashio Current		64.74		2,495.94		883.65		5,276.82
		Russian Federation to LME#52. Sea of Okhotsk		311.68		12,016.99		4,254.46		25,405.91
		Russian Federation to LME#53. West Bering Sea		42.33		1,632.19		577.86		3,450.72
682	Saudi Arabia	Saudi Arabia to LME#32. Arabian Sea	10,936.85	5,684.01	58,050.86	30,169.71	20,552.17	10,681.20	122,729.09	63,783.75
2		Saudi Arabia to LME#33. Red Sea		5,252.84		27,881.15		9,870.96		58,945.34
686	Senegal	Senegal to LME#27. Canary Current	3,391.52	3,391.52	3,826.67	3,826.67	1,354.78	1,354.78	8,090.22	8,090.22
688	Serbia	Serbia to LME#62. Black Sea	10,695.46	8,438.03	52,727.40	41,598.53	18,667.47	14,727.43	111,474.42	87,946.16
2		Serbia to LME#26. Mediterranean		2,257.43		11,128.87		3,940.04		23,528.27

694	Sierra Leone	Sierra Leone to LME#28. Guinea Current	17,638.63	17,638.63	20,790.05	20,790.05	7,360.45	7,360.45	43,953.59	43,953.59
703	Slovakia	Slovakia to LME#62. Black Sea	19,961.73	19,961.73	41,598.53	41,598.53	14,727.43	14,727.43	87,946.16	87,946.16
704	Viet Nam	Viet Nam to LME#36. South China Sea	10,915.28	10,915.28	13,660.98	13,660.98	4,836.50	4,836.50	28,881.56	28,881.56
705	Slovenia	Slovenia to LME#26. Mediterranean	6,616.68	6,616.68	11,128.87	11,128.87	3,940.04	3,940.04	23,528.27	23,528.27
706	Somalia	Somalia to LME#31. Somali Coastal Current	7,975.11	538.42	32,354.00	2,184.28	11,454.52	773.32	68,401.68	4,617.93
2		Somalia to LME#32. Arabian Sea		7,436.70		30,169.71		10,681.20		63,783.75
710	South Africa	South Africa to LME#29. Benguela Current	3,247.27	1,201.24	12,472.19	4,613.74	4,415.62	1,633.44	26,368.26	9,754.22
2		South Africa to LME#30. Agulhas Current		2,046.03		7,858.44		2,782.18		16,614.04
716	Zimbabwe	Zimbabwe to LME#30. Agulhas Current	4,303.58	4,303.58	7,858.44	7,858.44	2,782.18	2,782.18	16,614.04	16,614.04
724	Spain	Spain to LME#25. Iberian Coastal	3,678.77	714.43	13,811.04	2,682.17	4,889.62	949.59	29,198.82	5,670.55
2		Spain to LME#26. Mediterranean		2,964.33		11,128.87		3,940.04		23,528.27
736	Sudan	Sudan to LME#33. Red Sea	11,750.93	11,750.93	27,881.15	27,881.15	9,870.96	9,870.96	58,945.34	58,945.34
742	Swaziland	Swaziland to LME#30. Agulhas Current	5,466.38	5,466.38	7,858.44	7,858.44	2,782.18	2,782.18	16,614.04	16,614.04
752	Sweden	Sweden to LME#23. Baltic Sea	21,154.72	16,311.16	92,574.02	71,378.35	32,774.65	25,270.60	195,716.75	150,905.61
2		Sweden to LME#22. North Sea		4,843.57		21,195.67		7,504.06		44,811.14
756	Switzerland	Switzerland to LME#22. North Sea	9,455.26	2,711.07	73,923.07	21,195.67	26,171.52	7,504.06	156,285.57	44,811.14
3		Switzerland to LME#26. Mediterranean		1,423.46		11,128.87		3,940.04		23,528.27
		Switzerland to LME#62. Black Sea		5,320.73		41,598.53		14,727.43		87,946.16
760	Syrian Arab Republic	Syrian Arab Republic to LME#26. Mediterranean	5,188.23	5,188.23	11,128.87	11,128.87	3,940.04	3,940.04	23,528.27	23,528.27
764	Thailand	Thailand to LME#34. Bay of Bengal	13,886.51	13,886.51	21,167.69	21,167.69	7,494.15	7,494.15	44,752.00	44,752.00
768	Togo	Togo to LME#28. Guinea Current	14,057.36	14,057.36	20,790.05	20,790.05	7,360.45	7,360.45	43,953.59	43,953.59
784	United Arab Emirates	United Arab Emirates to LME#32. Arabian Sea	20,715.44	20,715.44	30,169.71	30,169.71	10,681.20	10,681.20	63,783.75	63,783.75
788	Tunisia	Tunisia to LME#26. Mediterranean	7,601.66	7,601.66	11,128.87	11,128.87	3,940.04	3,940.04	23,528.27	23,528.27
792	Turkey	Turkey to LME#26. Mediterranean	5,982.32	5,982.32	11,128.87	11,128.87	3,940.04	3,940.04	23,528.27	23,528.27
800	Uganda	Uganda to LME#26. Mediterranean	4,814.88	4,814.88	11,128.87	11,128.87	3,940.04	3,940.04	23,528.27	23,528.27
804	Ukraine	Ukraine to LME#62. Black Sea	18,287.34	18,287.34	41,598.53	41,598.53	14,727.43	14,727.43	87,946.16	87,946.16
807	The FYR of Macedonia	The FYR of Macedonia to LME#26. Mediterranean	6,534.89	6,534.89	11,128.87	11,128.87	3,940.04	3,940.04	23,528.27	23,528.27
818	Egypt	Egypt to LME#26. Mediterranean	5,560.13	5,560.13	11,128.87	11,128.87	3,940.04	3,940.04	23,528.27	23,528.27
826	United Kingdom of GB and NI	United Kingdom of GB and NI to LME#22. North Sea	10,712.59	5,874.84	38,649.65	21,195.67	13,683.42	7,504.06	81,711.73	44,811.14
2		United Kingdom of GB and NI to LME#24. Celtic-Biscay Shelf		4,837.75		17,453.98		6,179.36		36,900.59
834	United Republic of Tanzania: Mainland	United Republic of Tanzania: Mainland to LME#30. Agulhas Current	4,084.75	4,084.75	7,858.44	7,858.44	2,782.18	2,782.18	16,614.04	16,614.04
840	United States	United States to LME#1. East Bering Sea	1,942.30	339.36	65,282.46	11,406.01	23,112.42	4,038.15	138,017.88	24,114.20
10		United States to LME#2. Gulf of Alaska		99.95		3,359.50		1,189.39		7,102.53
		United States to LME#3. California Current		48.97		1,645.78		582.67		3,479.44
		United States to LME#4. Gulf of California		468.48		15,746.08		5,574.70		33,289.80
		United States to LME#5. Gulf of Mexico		469.85		15,792.03		5,590.97		33,386.96
		United States to LME#6. Southeast U.S. Continental Shelf		60.10		2,019.95		715.14		4,270.51
		United States to LME#7. Northeast U.S. Continental Shelf		194.64		6,541.93		2,316.09		13,830.72
		United States to LME#10. Insular Pacific-Hawaiian		16.63		558.87		197.86		1,181.53
		United States to LME#54. Chukchi Sea		101.59		3,414.44		1,208.84		7,218.69
		United States to LME#55. Beaufort Sea		142.75		4,797.87		1,698.62		10,143.49
858	Uruguay	Uruguay to LME#14. Patagonian Shelf	4,786.56	4,786.56	5,793.14	5,793.14	2,050.99	2,050.99	12,247.66	12,247.66
862	Venezuela (Bolivarian Republic of)	Venezuela (Bolivarian Republic of) to LME#12. Caribbean Sea	874.99	874.99	1,163.28	1,163.28	411.84	411.84	2,459.37	2,459.37
887	Yemen	Yemen to LME#32. Arabian Sea	18,551.47	18,551.47	30,169.71	30,169.71	10,681.20	10,681.20	63,783.75	63,783.75
894	Zambia	Zambia to LME#30. Agulhas Current	3,721.39	3,721.39	7,858.44	7,858.44	2,782.18	2,782.18	16,614.04	16,614.04
			n=214		n=143	n=214		n=143	n=214	

**Table 3.16:** Characterisation Factors (CF) and total N emission to air at Country-to-LME scale.

ISO #	Country-to-LME	Emission: N to air	
		Resolution scale: Country-to-LME	
		CF "N to air" (PAF-)[m <sup>3</sup> -d/kg]	Emission to air [kg/yr]
8	Albania to LME#26. Mediterranean	7,606.07	2.21E+07
12	Algeria to LME#26. Mediterranean	7,211.38	1.76E+08
24	Angola to LME#29. Benguela Current	2,490.13	8.24E+08
32	Argentina to LME#14. Patagonian Shelf	4,416.45	1.09E+09
36	Australia to LME#39. North Australia	154.64	2.28E+08
	Australia to LME#40. Northeast Australia	48.29	2.28E+08
	Australia to LME#41. East-Central Australia	52.72	2.28E+08
	Australia to LME#42. Southeast Australia	81.68	2.28E+08
	Australia to LME#43. Southwest Australia	78.27	2.28E+08
	Australia to LME#44. West-Central Australia	59.76	2.28E+08
	Australia to LME#45. Northwest Australia	75.31	2.28E+08
40	Austria to LME#26. Mediterranean	5,986.51	1.74E+08
44	Bahamas to LME#12. Caribbean Sea	1,490.85	3.91E+06
50	Bangladesh to LME#34. Bay of Bengal	11,107.20	4.99E+08
56	Belgium to LME#22. North Sea	14,146.99	9.24E+07
64	Bhutan to LME#34. Bay of Bengal	9,743.61	3.36E+07
68	Bolivia to LME#13. Humboldt Current	214.72	4.31E+08
70	Bosnia and Herzegovina to LME#26. Mediterranean	6,433.01	3.59E+07
72	Botswana to LME#30. Agulhas Current	4,689.03	1.14E+08
76	Brazil to LME#15. South Brazil Shelf	280.94	1.76E+09
	Brazil to LME#16. East Brazil Shelf	122.26	1.76E+09
	Brazil to LME#17. North Brazil Shelf	571.46	1.76E+09
84	Belize to LME#12. Caribbean Sea	1,097.00	1.66E+07
92	Virgin Islands (British) to LME#12. Caribbean Sea	1,692.38	2.47E+04
100	Bulgaria to LME#26. Mediterranean	2,330.43	7.58E+07
	Bulgaria to LME#62. Black Sea	8,710.90	7.58E+07
104	Myanmar to LME#34. Bay of Bengal	12,033.02	4.63E+08
112	Belarus to LME#23. Baltic Sea	29,863.38	2.11E+08
116	Cambodia to LME#3. California Current	1,187.57	1.58E+08
120	Cameroon to LME#28. Guinea Current	10,509.35	3.07E+08
124	Canada to LME#2. Gulf of Alaska	216.39	2.98E+08
	Canada to LME#63. Hudson Bay	524.41	2.98E+08
	Canada to LME#9. Newfoundland-Labrador Shelf	157.96	2.98E+08
	Canada to LME#8. Scotian Shelf	1,060.60	2.98E+08
	Canada to LME#64. Arctic Ocean	15.12	2.98E+08
144	Sri Lanka to LME#34. Bay of Bengal	25,932.46	4.68E+07
152	Chile to LME#13. Humboldt Current	369.57	9.13E+07
156	China, People's Republic of to LME#36. South China Sea	1,810.54	4.93E+09
	China, People's Republic of to LME#47. East China Sea	1,650.06	4.93E+09
	China, People's Republic of to LME#48. Yellow Sea	4,477.33	4.93E+09
170	Colombia to LME#11. Pacific Central-American	523.34	3.06E+08
	Colombia to LME#12. Caribbean Sea	286.64	3.06E+08
178	Congo to LME#28. Guinea Current	10,781.75	1.11E+08
180	Democratic Republic of the Congo to LME#28. Guinea Current	8,817.57	1.59E+09
188	Costa Rica to LME#11. Pacific Central-American	744.33	1.61E+07
	Costa Rica to LME#12. Caribbean Sea	407.68	1.61E+07
191	Croatia to LME#26. Mediterranean	6,318.80	6.39E+07
192	Cuba to LME#12. Caribbean Sea	1,445.79	8.10E+07
196	Cyprus to LME#26. Mediterranean	8,841.96	3.92E+06
203	Czech Republic to LME#22. North Sea	10,857.65	1.76E+08
204	Benin to LME#28. Guinea Current	13,077.95	9.12E+07
208	Denmark to LME#22. North Sea	3,117.37	2.38E+07
	Denmark to LME#23. Baltic Sea	10,498.03	2.38E+07
	Denmark to LME#60. Faroe Plateau	188.33	2.38E+07
214	Dominican Republic to LME#12. Caribbean Sea	1,545.87	3.20E+07
218	Ecuador to LME#11. Pacific Central-American	1,521.96	1.27E+08
222	El Salvador to LME#11. Pacific Central-American	2,097.28	2.60E+07
226	Equatorial Guinea to LME#28. Guinea Current	14,004.93	5.00E+06
231	Ethiopia to LME#32. Arabian Sea	5,792.04	4.56E+08
	Ethiopia to LME#33. Red Sea	5,352.68	4.56E+08
232	Eritrea to LME#33. Red Sea	15,412.99	5.24E+07
233	Estonia to LME#23. Baltic Sea	38,535.67	2.16E+07
238	Falkland Islands (Malvinas) to LME#14. Patagonian Shelf	9,187.22	4.05E+05
246	Finland to LME#23. Baltic Sea	38,643.28	1.17E+08
250	France to LME#22. North Sea	2,913.86	3.20E+08
	France to LME#24. Celtic-Biscay Shelf	2,399.47	3.20E+08
	France to LME#26. Mediterranean	1,529.93	3.20E+08

262	Djibouti to LME#32. Arabian Sea	18,417.86	8.30E+06
266	Gabon to LME#28. Guinea Current	13,043.97	5.03E+07
268	Georgia to LME#62. Black Sea	17,264.22	4.72E+07
270	Gambia to LME#28. Guinea Current	19,658.43	3.96E+06
276	Germany to LME#22. North Sea	4,562.65	4.97E+08
	Germany to LME#23. Baltic Sea	15,365.15	4.97E+08
288	Ghana to LME#28. Guinea Current	14,639.52	1.85E+08
300	Greece to LME#26. Mediterranean	8,120.22	8.86E+07
320	Guatemala to LME#11. Pacific Central-American	651.24	3.56E+07
	Guatemala to LME#12. Caribbean Sea	356.69	3.56E+07
324	Guinea to LME#28. Guinea Current	16,406.40	1.57E+08
328	Guyana to LME#17. North Brazil Shelf	3,889.58	1.05E+07
332	Haiti to LME#12. Caribbean Sea	1,517.80	1.15E+07
340	Honduras to LME#12. Caribbean Sea	1,133.63	9.10E+07
348	Hungary to LME#62. Black Sea	20,356.52	1.55E+08
352	Iceland to LME#59. Iceland Shelf	1,402.27	4.32E+06
356	India to LME#32. Arabian Sea	6,332.80	3.18E+09
	India to LME#34. Bay of Bengal	4,443.22	3.18E+09
360	Indonesia to LME#38. Indonesian Sea	6,011.18	1.04E+09
364	Iran, Islamic Republic of to LME#32. Arabian Sea	13,376.15	7.71E+08
368	Iraq to LME#32. Arabian Sea	12,920.81	1.34E+08
372	Ireland to LME#24. Celtic-Biscay Shelf	17,768.49	5.87E+07
376	Israel to LME#26. Mediterranean	6,128.33	5.64E+06
380	Italy to LME#26. Mediterranean	7,754.52	4.48E+08
381	Kosovo to LME#26. Mediterranean	6,004.91	1.15E+07
384	Côte d'Ivoire to LME#28. Guinea Current	15,667.52	1.78E+08
388	Jamaica to LME#12. Caribbean Sea	1,571.02	3.37E+06
392	Japan to LME#47. East China Sea	1,138.15	2.98E+07
	Japan to LME#49. Kuroshio Current	491.17	2.98E+07
	Japan to LME#50. Sea of Japan/East Sea	1,811.28	2.98E+07
	Japan to LME#51. Oyashio Current	228.17	2.98E+07
	Japan to LME#52. Sea of Okhotsk	1,098.56	2.98E+07
400	Jordan to LME#33. Red Sea	13,339.20	2.11E+07
404	Kenya to LME#31. Somali Coastal Current	1,162.60	4.01E+08
408	Democratic People's Republic of Korea to LME#47. East China Sea	1,949.18	4.23E+07
	Democratic People's Republic of Korea to LME#48. Yellow Sea	5,288.96	4.23E+07
	Democratic People's Republic of Korea to LME#50. Sea of Japan/East Sea	3,101.98	4.23E+07
410	Republic of Korea to LME#47. East China Sea	2,131.22	2.60E+07
	Republic of Korea to LME#48. Yellow Sea	5,782.93	2.60E+07
	Republic of Korea to LME#50. Sea of Japan/East Sea	3,391.69	2.60E+07
418	Lao People's Democratic Republic to LME#36. South China Sea	9,051.71	1.62E+08
422	Lebanon to LME#26. Mediterranean	6,439.34	3.81E+06
428	Latvia to LME#23. Baltic Sea	35,828.36	3.93E+07
430	Liberia to LME#28. Guinea Current	18,505.35	2.34E+07
434	Libyan Arab Jamahiriya to LME#26. Mediterranean	6,311.36	5.48E+07
440	Lithuania to LME#23. Baltic Sea	33,510.99	5.53E+07
450	Madagascar to LME#30. Agulhas Current	6,968.10	2.44E+08
458	Malaysia to LME#34. Bay of Bengal	3,758.44	9.41E+07
	Malaysia to LME#35. Gulf of Thailand	76.35	9.41E+07
	Malaysia to LME#36. South China Sea	2,425.58	9.41E+07
466	Mali to LME#27. Canary Current	914.58	1.48E+08
	Mali to LME#28. Guinea Current	4,968.83	1.48E+08
478	Mauritania to LME#27. Canary Current	2,965.74	8.71E+07
484	Mexico to LME#3. California Current	247.74	4.34E+08
	Mexico to LME#4. Gulf of California	2,370.27	4.34E+08
	Mexico to LME#5. Gulf of Mexico	2,377.19	4.34E+08
498	Moldova to LME#62. Black Sea	19,732.66	5.15E+07
499	Montenegro to LME#26. Mediterranean	6,004.91	1.49E+07
504	Morocco to LME#26. Mediterranean	2,867.41	7.03E+07
	Morocco to LME#27. Canary Current	985.96	7.03E+07
508	Mozambique to LME#30. Agulhas Current	5,012.94	4.06E+08
512	Oman to LME#32. Arabian Sea	21,274.65	4.48E+07
516	Namibia to LME#29. Benguela Current	3,124.29	1.25E+08
524	Nepal to LME#34. Bay of Bengal	9,178.18	2.85E+08
528	Netherlands to LME#22. North Sea	14,615.34	1.28E+08
540	New Caledonia to LME#40. Northeast Australia	1,692.66	1.01E+06
554	New Zealand to LME#46. New Zealand Shelf	2,518.46	8.06E+07
558	Nicaragua to LME#11. Pacific Central-American	691.81	3.21E+07
	Nicaragua to LME#12. Caribbean Sea	378.91	3.21E+07
562	Niger to LME#28. Guinea Current	10,873.93	1.56E+08
566	Nigeria to LME#28. Guinea Current	11,375.19	7.85E+08
578	Norway to LME#21. Norwegian Sea	1,528.58	2.58E+07
	Norway to LME#22. North Sea	5,111.80	2.58E+07
586	Pakistan to LME#32. Arabian Sea	13,556.88	7.85E+08

591	Panama to LME#11. Pacific Central-American	736.68	1.33E+07
	Panama to LME#12. Caribbean Sea	403.49	1.33E+07
600	Paraguay to LME#14. Patagonian Shelf	3,331.12	2.24E+08
604	Peru to LME#13. Humboldt Current	301.05	3.12E+08
608	Philippines to LME#36. South China Sea	5,097.96	5.70E+07
	Philippines to LME#37. Sulu-Celebes Sea	6,425.88	5.70E+07
616	Poland to LME#23. Baltic Sea	35,107.62	5.63E+08
620	Portugal to LME#25. Iberian Coastal	2,497.74	9.22E+07
624	Guinea-Bissau to LME#28. Guinea Current	18,512.85	1.16E+07
626	Timor-Leste to LME#38. Indonesian Sea	8,710.92	4.28E+06
630	Puerto Rico to LME#12. Caribbean Sea	1,612.49	3.68E+06
642	Romania to LME#62. Black Sea	20,602.61	3.47E+08
643	Russian Federation to LME#20. Barents Sea	128.55	3.40E+08
	Russian Federation to LME#54. Chukchi Sea	88.56	3.40E+08
	Russian Federation to LME#56. East Siberian Sea	46.31	3.40E+08
	Russian Federation to LME#57. Laptev Sea	175.99	3.40E+08
	Russian Federation to LME#58. Kara Sea	134.64	3.40E+08
	Russian Federation to LME#62. Black Sea	1,078.91	3.40E+08
	Russian Federation to LME#64. Arctic Ocean	6.09	3.40E+08
	Russian Federation to LME#50. Sea of Japan/East Sea	513.89	3.40E+08
	Russian Federation to LME#51. Oyashio Current	64.74	3.40E+08
	Russian Federation to LME#52. Sea of Okhotsk	311.68	3.40E+08
	Russian Federation to LME#53. West Bering Sea	42.33	3.40E+08
682	Saudi Arabia to LME#32. Arabian Sea	5,684.01	2.37E+08
	Saudi Arabia to LME#33. Red Sea	5,252.84	2.37E+08
686	Senegal to LME#27. Canary Current	3,391.52	8.92E+07
688	Serbia to LME#62. Black Sea	8,438.03	4.18E+07
	Serbia to LME#26. Mediterranean	2,257.43	4.18E+07
694	Sierra Leone to LME#28. Guinea Current	17,638.63	2.48E+07
703	Slovakia to LME#62. Black Sea	19,961.73	9.68E+07
704	Viet Nam to LME#36. South China Sea	10,915.28	3.78E+08
705	Slovenia to LME#26. Mediterranean	6,616.68	3.80E+07
706	Somalia to LME#31. Somali Coastal Current	538.42	1.33E+08
	Somalia to LME#32. Arabian Sea	7,436.70	1.33E+08
710	South Africa to LME#29. Benguela Current	1,201.24	3.59E+08
	South Africa to LME#30. Agulhas Current	2,046.03	3.59E+08
716	Zimbabwe to LME#30. Agulhas Current	4,303.58	1.86E+08
724	Spain to LME#25. Iberian Coastal	714.43	3.26E+08
	Spain to LME#26. Mediterranean	2,964.33	3.26E+08
736	Sudan to LME#33. Red Sea	11,750.93	1.54E+09
748	Swaziland to LME#30. Agulhas Current	5,466.38	2.47E+07
752	Sweden to LME#23. Baltic Sea	16,311.16	7.76E+07
	Sweden to LME#22. North Sea	4,843.57	7.76E+07
756	Switzerland to LME#22. North Sea	2,711.07	2.75E+07
	Switzerland to LME#26. Mediterranean	1,423.46	2.75E+07
	Switzerland to LME#62. Black Sea	5,320.73	2.75E+07
760	Syrian Arab Republic to LME#26. Mediterranean	5,188.23	1.22E+08
764	Thailand to LME#34. Bay of Bengal	13,886.51	3.54E+08
768	Togo to LME#28. Guinea Current	14,057.36	4.64E+07
784	United Arab Emirates to LME#32. Arabian Sea	20,715.44	2.68E+07
788	Tunisia to LME#26. Mediterranean	7,601.66	4.53E+07
792	Turkey to LME#26. Mediterranean	5,982.32	6.56E+08
800	Uganda to LME#26. Mediterranean	4,814.88	2.51E+08
804	Ukraine to LME#62. Black Sea	18,287.34	8.65E+08
807	The FYR of Macedonia to LME#26. Mediterranean	6,534.89	2.78E+07
818	Egypt to LME#26. Mediterranean	5,560.13	1.79E+08
826	United Kingdom of GB and NI to LME#22. North Sea	5,874.84	2.32E+08
	United Kingdom of GB and NI to LME#24. Celtic-Biscay Shelf	4,837.75	2.32E+08
834	United Republic of Tanzania: Mainland to LME#30. Agulhas Current	4,084.75	6.97E+08
840	United States to LME#1. East Bering Sea	339.36	8.50E+08
	United States to LME#2. Gulf of Alaska	99.95	8.50E+08
	United States to LME#3. California Current	48.97	8.50E+08
	United States to LME#4. Gulf of California	468.48	8.50E+08
	United States to LME#5. Gulf of Mexico	469.85	8.50E+08
	United States to LME#6. Southeast U.S. Continental Shelf	60.10	8.50E+08
	United States to LME#7. Northeast U.S. Continental Shelf	194.64	8.50E+08
	United States to LME#10. Insular Pacific-Hawaiian	16.63	8.50E+08
	United States to LME#54. Chukchi Sea	101.59	8.50E+08
	United States to LME#55. Beaufort Sea	142.75	8.50E+08
858	Uruguay to LME#14. Patagonian Shelf	4,786.56	1.74E+08
862	Venezuela (Bolivarian Republic of) to LME#12. Caribbean Sea	874.99	5.62E+08
887	Yemen to LME#32. Arabian Sea	18,551.47	1.29E+08
894	Zambia to LME#30. Agulhas Current	3,721.39	6.64E+08

**Table 3.17:** Characterisation Factors (CF) and total N emission to surface freshwater (sfw) at Country-to-LME scale.

ISO #	Country-to-LME	Emission: N to freshwater	
		Resolution scale: Country-to-LME	
		CF "N to freshwater" (PAF-)[m <sup>3</sup> -d/kg]	Emission to fw [kg/yr]
8	Albania to LME#26. Mediterranean	11,128.87	1.47E+13
12	Algeria to LME#26. Mediterranean	11,128.87	1.44E+14
24	Angola to LME#29. Benguela Current	4,613.74	7.25E+13
32	Argentina to LME#14. Patagonian Shelf	5,793.14	5.01E+14
36	Australia to LME#39. North Australia	3,094.40	1.05E+13
	Australia to LME#40. Northeast Australia	966.37	1.05E+13
	Australia to LME#41. East-Central Australia	1,054.97	1.05E+13
	Australia to LME#42. Southeast Australia	1,634.43	1.05E+13
	Australia to LME#43. Southwest Australia	1,566.22	1.05E+13
	Australia to LME#44. West-Central Australia	1,195.88	1.05E+13
	Australia to LME#45. Northwest Australia	1,506.92	1.05E+13
40	Austria to LME#26. Mediterranean	11,128.87	4.08E+13
44	Bahamas to LME#12. Caribbean Sea	1,163.28	1.35E+12
50	Bangladesh to LME#34. Bay of Bengal	21,167.69	9.71E+14
56	Belgium to LME#22. North Sea	21,195.67	9.43E+13
64	Bhutan to LME#34. Bay of Bengal	21,167.69	3.89E+10
68	Bolivia to LME#13. Humboldt Current	422.52	1.01E+14
70	Bosnia and Herzegovina to LME#26. Mediterranean	11,128.87	1.35E+13
72	Botswana to LME#30. Agulhas Current	7,858.44	3.42E+13
76	Brazil to LME#15. South Brazil Shelf	2,212.79	2.11E+14
	Brazil to LME#16. East Brazil Shelf	962.97	2.11E+14
	Brazil to LME#17. North Brazil Shelf	4,500.99	2.11E+14
84	Belize to LME#12. Caribbean Sea	1,163.28	1.84E+12
92	Virgin Islands (British) to LME#12. Caribbean Sea	1,163.28	8.07E+08
100	Bulgaria to LME#26. Mediterranean	11,128.87	7.62E+12
	Bulgaria to LME#62. Black Sea	41,598.53	7.62E+12
104	Myanmar to LME#34. Bay of Bengal	21,167.69	1.90E+14
112	Belarus to LME#23. Baltic Sea	71,378.35	8.36E+13
116	Cambodia to LME#3. California Current	1,645.78	8.64E+11
120	Cameroon to LME#28. Guinea Current	20,790.05	7.03E+13
124	Canada to LME#2. Gulf of Alaska	3,359.50	1.33E+13
	Canada to LME#63. Hudson Bay	8,141.68	1.33E+13
	Canada to LME#9. Newfoundland-Labrador Shelf	2,452.32	1.33E+13
	Canada to LME#8. Scotian Shelf	16,466.06	1.33E+13
	Canada to LME#64. Arctic Ocean	234.71	1.33E+13
144	Sri Lanka to LME#34. Bay of Bengal	21,167.69	7.71E+13
152	Chile to LME#13. Humboldt Current	422.52	1.22E+14
156	China, People's Republic of to LME#36. South China Sea	13,660.98	1.03E+15
	China, People's Republic of to LME#47. East China Sea	12,450.11	1.03E+15
	China, People's Republic of to LME#48. Yellow Sea	33,782.51	1.03E+15
170	Colombia to LME#11. Pacific Central-American	2,123.90	9.09E+13
	Colombia to LME#12. Caribbean Sea	1,163.28	9.09E+13
178	Congo to LME#28. Guinea Current	20,790.05	6.09E+12
180	Democratic Republic of the Congo to LME#28. Guinea Current	20,790.05	3.53E+13
188	Costa Rica to LME#11. Pacific Central-American	2,123.90	8.32E+12
	Costa Rica to LME#12. Caribbean Sea	1,163.28	8.32E+12
191	Croatia to LME#26. Mediterranean	11,128.87	2.73E+13
192	Cuba to LME#12. Caribbean Sea	1,163.28	4.79E+13
196	Cyprus to LME#26. Mediterranean	11,128.87	9.33E+12
203	Czech Republic to LME#22. North Sea	21,195.67	3.01E+13
204	Benin to LME#28. Guinea Current	20,790.05	2.26E+13
208	Denmark to LME#22. North Sea	21,195.67	7.97E+12
	Denmark to LME#23. Baltic Sea	71,378.35	7.97E+12
	Denmark to LME#60. Faroe Plateau	1,280.49	7.97E+12
214	Dominican Republic to LME#12. Caribbean Sea	1,163.28	3.61E+13
218	Ecuador to LME#11. Pacific Central-American	2,123.90	7.92E+13
222	El Salvador to LME#11. Pacific Central-American	2,123.90	2.29E+13
226	Equatorial Guinea to LME#28. Guinea Current	20,790.05	6.68E+11
231	Ethiopia to LME#32. Arabian Sea	30,169.71	8.50E+13
	Ethiopia to LME#33. Red Sea	27,881.15	8.50E+13
232	Eritrea to LME#33. Red Sea	27,881.15	2.32E+13
233	Estonia to LME#23. Baltic Sea	71,378.35	6.34E+12
238	Falkland Islands (Malvinas) to LME#14. Patagonian Shelf	5,793.14	2.30E+11
246	Finland to LME#23. Baltic Sea	71,378.35	4.20E+13
250	France to LME#22. North Sea	21,195.67	3.42E+13
	France to LME#24. Celtic-Biscay Shelf	17,453.98	3.42E+13
	France to LME#26. Mediterranean	11,128.87	3.42E+13

262	Djibouti to LME#32. Arabian Sea	30,169.71	1.99E+11
266	Gabon to LME#28. Guinea Current	20,790.05	4.61E+12
268	Georgia to LME#62. Black Sea	41,598.53	5.73E+13
270	Gambia to LME#28. Guinea Current	20,790.05	2.92E+12
276	Germany to LME#22. North Sea	21,195.67	7.50E+13
	Germany to LME#23. Baltic Sea	71,378.35	7.50E+13
288	Ghana to LME#28. Guinea Current	20,790.05	2.35E+13
300	Greece to LME#26. Mediterranean	11,128.87	3.93E+13
320	Guatemala to LME#11. Pacific Central-American	2,123.90	1.65E+13
	Guatemala to LME#12. Caribbean Sea	1,163.28	1.65E+13
324	Guinea to LME#28. Guinea Current	20,790.05	3.02E+13
328	Guyana to LME#17. North Brazil Shelf	4,500.99	3.40E+12
332	Haiti to LME#12. Caribbean Sea	1,163.28	3.25E+13
340	Honduras to LME#12. Caribbean Sea	1,163.28	5.76E+13
348	Hungary to LME#62. Black Sea	41,598.53	5.78E+13
352	Iceland to LME#59. Iceland Shelf	1,510.10	2.97E+12
356	India to LME#32. Arabian Sea	30,169.71	2.65E+15
	India to LME#34. Bay of Bengal	21,167.69	2.65E+15
360	Indonesia to LME#38. Indonesian Sea	5,930.87	7.26E+14
364	Iran, Islamic Republic of to LME#32. Arabian Sea	30,169.71	7.24E+14
368	Iraq to LME#32. Arabian Sea	30,169.71	1.97E+14
372	Ireland to LME#24. Celtic-Biscay Shelf	17,453.98	1.03E+14
376	Israel to LME#26. Mediterranean	11,128.87	3.27E+13
380	Italy to LME#26. Mediterranean	11,128.87	1.16E+14
381	Kosovo to LME#26. Mediterranean	11,128.87	5.75E+12
384	Côte d'Ivoire to LME#28. Guinea Current	20,790.05	3.75E+13
388	Jamaica to LME#12. Caribbean Sea	1,163.28	6.59E+12
392	Japan to LME#47. East China Sea	12,450.11	1.33E+13
	Japan to LME#49. Kuroshio Current	5,372.88	1.33E+13
	Japan to LME#50. Sea of Japan/East Sea	19,813.46	1.33E+13
	Japan to LME#51. Oyashio Current	2,495.94	1.33E+13
	Japan to LME#52. Sea of Okhotsk	12,016.99	1.33E+13
400	Jordan to LME#33. Red Sea	27,881.15	2.03E+13
404	Kenya to LME#31. Somali Coastal Current	2,184.28	1.51E+14
408	Democratic People's Republic of Korea to LME#47. East China Sea	12,450.11	7.77E+12
	Democratic People's Republic of Korea to LME#48. Yellow Sea	33,782.51	7.77E+12
	Democratic People's Republic of Korea to LME#50. Sea of Japan/East Sea	19,813.46	7.77E+12
410	Republic of Korea to LME#47. East China Sea	12,450.11	1.45E+13
	Republic of Korea to LME#48. Yellow Sea	33,782.51	1.45E+13
	Republic of Korea to LME#50. Sea of Japan/East Sea	19,813.46	1.45E+13
418	Lao People's Democratic Republic to LME#36. South China Sea	13,660.98	2.52E+13
422	Lebanon to LME#26. Mediterranean	11,128.87	1.87E+13
428	Latvia to LME#23. Baltic Sea	71,378.35	9.95E+12
430	Liberia to LME#28. Guinea Current	20,790.05	6.39E+11
434	Libyan Arab Jamahiriya to LME#26. Mediterranean	11,128.87	5.41E+13
440	Lithuania to LME#23. Baltic Sea	71,378.35	2.24E+13
450	Madagascar to LME#30. Agulhas Current	7,858.44	9.91E+13
458	Malaysia to LME#34. Bay of Bengal	21,167.69	1.14E+13
	Malaysia to LME#35. Gulf of Thailand	429.98	1.14E+13
	Malaysia to LME#36. South China Sea	13,660.98	1.14E+13
466	Mali to LME#27. Canary Current	3,826.67	2.25E+13
	Mali to LME#28. Guinea Current	20,790.05	2.25E+13
478	Mauritania to LME#27. Canary Current	3,826.67	6.91E+12
484	Mexico to LME#3. California Current	1,645.78	8.73E+13
	Mexico to LME#4. Gulf of California	15,746.08	8.73E+13
	Mexico to LME#5. Gulf of Mexico	15,792.03	8.73E+13
498	Moldova to LME#62. Black Sea	41,598.53	9.82E+12
499	Montenegro to LME#26. Mediterranean	11,128.87	7.44E+12
504	Morocco to LME#26. Mediterranean	11,128.87	4.95E+13
	Morocco to LME#27. Canary Current	3,826.67	4.95E+13
508	Mozambique to LME#30. Agulhas Current	7,858.44	4.58E+13
512	Oman to LME#32. Arabian Sea	30,169.71	4.62E+10
516	Namibia to LME#29. Benguela Current	4,613.74	1.13E+13
524	Nepal to LME#34. Bay of Bengal	21,167.69	1.95E+14
528	Netherlands to LME#22. North Sea	21,195.67	9.78E+13
540	New Caledonia to LME#40. Northeast Australia	966.37	7.98E+11
554	New Zealand to LME#46. New Zealand Shelf	1,871.56	2.89E+14
558	Nicaragua to LME#11. Pacific Central-American	2,123.90	6.69E+12
	Nicaragua to LME#12. Caribbean Sea	1,163.28	6.69E+12
562	Niger to LME#28. Guinea Current	20,790.05	3.68E+13
566	Nigeria to LME#28. Guinea Current	20,790.05	2.28E+14
578	Norway to LME#21. Norwegian Sea	6,338.15	8.14E+12
	Norway to LME#22. North Sea	21,195.67	8.14E+12
586	Pakistan to LME#32. Arabian Sea	30,169.71	2.49E+15



591	Panama to LME#11. Pacific Central-American	2,123.90	3.19E+12
	Panama to LME#12. Caribbean Sea	1,163.28	3.19E+12
600	Paraguay to LME#14. Patagonian Shelf	5,793.14	9.22E+13
604	Peru to LME#13. Humboldt Current	422.52	1.29E+14
608	Philippines to LME#36. South China Sea	13,660.98	6.49E+13
	Philippines to LME#37. Sulu-Celebes Sea	17,219.40	6.49E+13
616	Poland to LME#23. Baltic Sea	71,378.35	1.75E+14
620	Portugal to LME#25. Iberian Coastal	2,682.17	4.74E+13
624	Guinea-Bissau to LME#28. Guinea Current	20,790.05	6.93E+12
626	Timor-Leste to LME#38. Indonesian Sea	5,930.87	1.82E+11
630	Puerto Rico to LME#12. Caribbean Sea	1,163.28	9.16E+12
642	Romania to LME#62. Black Sea	41,598.53	1.16E+14
643	Russian Federation to LME#20. Barents Sea	4,956.31	4.93E+12
	Russian Federation to LME#54. Chukchi Sea	3,414.44	4.93E+12
	Russian Federation to LME#56. East Siberian Sea	1,785.58	4.93E+12
	Russian Federation to LME#57. Laptev Sea	6,785.50	4.93E+12
	Russian Federation to LME#58. Kara Sea	5,191.29	4.93E+12
	Russian Federation to LME#62. Black Sea	41,598.53	4.93E+12
	Russian Federation to LME#64. Arctic Ocean	234.71	4.93E+12
	Russian Federation to LME#50. Sea of Japan/East Sea	19,813.46	4.93E+12
	Russian Federation to LME#51. Oyashio Current	2,495.94	4.93E+12
	Russian Federation to LME#52. Sea of Okhotsk	12,016.99	4.93E+12
	Russian Federation to LME#53. West Bering Sea	1,632.19	4.93E+12
682	Saudi Arabia to LME#32. Arabian Sea	30,169.71	2.97E+13
	Saudi Arabia to LME#33. Red Sea	27,881.15	2.97E+13
686	Senegal to LME#27. Canary Current	3,826.67	4.68E+13
688	Serbia to LME#62. Black Sea	41,598.53	1.05E+13
	Serbia to LME#26. Mediterranean	11,128.87	1.05E+13
694	Sierra Leone to LME#28. Guinea Current	20,790.05	6.57E+12
703	Slovakia to LME#62. Black Sea	41,598.53	1.99E+13
704	Viet Nam to LME#36. South China Sea	13,660.98	5.07E+14
705	Slovenia to LME#26. Mediterranean	11,128.87	1.42E+13
706	Somalia to LME#31. Somali Coastal Current	2,184.28	2.98E+13
	Somalia to LME#32. Arabian Sea	30,169.71	2.98E+13
710	South Africa to LME#29. Benguela Current	4,613.74	6.25E+13
	South Africa to LME#30. Agulhas Current	7,858.44	6.25E+13
716	Zimbabwe to LME#30. Agulhas Current	7,858.44	6.93E+13
724	Spain to LME#25. Iberian Coastal	2,682.17	1.03E+14
	Spain to LME#26. Mediterranean	11,128.87	1.03E+14
736	Sudan to LME#33. Red Sea	27,881.15	4.27E+14
748	Swaziland to LME#30. Agulhas Current	7,858.44	5.39E+12
752	Sweden to LME#23. Baltic Sea	71,378.35	6.86E+12
	Sweden to LME#22. North Sea	21,195.67	6.86E+12
756	Switzerland to LME#22. North Sea	21,195.67	3.85E+12
	Switzerland to LME#26. Mediterranean	11,128.87	3.85E+12
	Switzerland to LME#62. Black Sea	41,598.53	3.85E+12
760	Syrian Arab Republic to LME#26. Mediterranean	11,128.87	1.27E+14
764	Thailand to LME#34. Bay of Bengal	21,167.69	3.30E+14
768	Togo to LME#28. Guinea Current	20,790.05	9.38E+12
784	United Arab Emirates to LME#32. Arabian Sea	30,169.71	2.31E+10
788	Tunisia to LME#26. Mediterranean	11,128.87	6.29E+13
792	Turkey to LME#26. Mediterranean	11,128.87	4.30E+14
800	Uganda to LME#26. Mediterranean	11,128.87	6.18E+13
804	Ukraine to LME#62. Black Sea	41,598.53	2.04E+14
807	The FYR of Macedonia to LME#26. Mediterranean	11,128.87	8.19E+12
818	Egypt to LME#26. Mediterranean	11,128.87	6.28E+14
826	United Kingdom of GB and NI to LME#22. North Sea	21,195.67	4.52E+13
	United Kingdom of GB and NI to LME#24. Celtic-Biscay Shelf	17,453.98	4.52E+13
834	United Republic of Tanzania: Mainland to LME#30. Agulhas Current	7,858.44	1.48E+14
840	United States to LME#1. East Bering Sea	11,406.01	3.41E+13
	United States to LME#2. Gulf of Alaska	3,359.50	3.41E+13
	United States to LME#3. California Current	1,645.78	3.41E+13
	United States to LME#4. Gulf of California	15,746.08	3.41E+13
	United States to LME#5. Gulf of Mexico	15,792.03	3.41E+13
	United States to LME#6. Southeast U.S. Continental Shelf	2,019.95	3.41E+13
	United States to LME#7. Northeast U.S. Continental Shelf	6,541.93	3.41E+13
	United States to LME#10. Insular Pacific-Hawaiian	558.87	3.41E+13
	United States to LME#54. Chukchi Sea	3,414.44	3.41E+13
	United States to LME#55. Beaufort Sea	4,797.87	3.41E+13
858	Uruguay to LME#14. Patagonian Shelf	5,793.14	1.02E+14
862	Venezuela (Bolivarian Republic of) to LME#12. Caribbean Sea	1,163.28	2.06E+14
887	Yemen to LME#32. Arabian Sea	30,169.71	7.41E+13
894	Zambia to LME#30. Agulhas Current	7,858.44	5.20E+13

**Table 3.18:** Characterisation Factors (CF) and total N emission to groundwater (gw) at Country-to-LME scale.

ISO #	Country-to-LME	Emission: N to groundwater	
		Resolution scale: Country-to-LME	
		CF "N to groundwater" (PAF-)[m <sup>3</sup> -d/kg]	Emission to gw [kg/yr]
8	Albania to LME#26. Mediterranean	3,940.04	1.81E+14
12	Algeria to LME#26. Mediterranean	3,940.04	1.48E+15
24	Angola to LME#29. Benguela Current	1,633.44	1.56E+15
32	Argentina to LME#14. Patagonian Shelf	2,050.99	5.10E+15
36	Australia to LME#39. North Australia	1,095.53	1.97E+15
	Australia to LME#40. Northeast Australia	342.13	1.97E+15
	Australia to LME#41. East-Central Australia	373.50	1.97E+15
	Australia to LME#42. Southeast Australia	578.65	1.97E+15
	Australia to LME#43. Southwest Australia	554.50	1.97E+15
	Australia to LME#44. West-Central Australia	423.39	1.97E+15
	Australia to LME#45. Northwest Australia	533.51	1.97E+15
40	Austria to LME#26. Mediterranean	3,940.04	3.92E+14
44	Bahamas to LME#12. Caribbean Sea	411.84	5.91E+12
50	Bangladesh to LME#34. Bay of Bengal	7,494.15	3.69E+15
56	Belgium to LME#22. North Sea	7,504.06	7.13E+14
64	Bhutan to LME#34. Bay of Bengal	7,494.15	3.45E+12
68	Bolivia to LME#13. Humboldt Current	149.59	1.30E+15
70	Bosnia and Herzegovina to LME#26. Mediterranean	3,940.04	1.63E+14
72	Botswana to LME#30. Agulhas Current	2,782.18	7.38E+14
76	Brazil to LME#15. South Brazil Shelf	783.41	5.01E+15
	Brazil to LME#16. East Brazil Shelf	340.93	5.01E+15
	Brazil to LME#17. North Brazil Shelf	1,593.52	5.01E+15
84	Belize to LME#12. Caribbean Sea	411.84	1.04E+13
92	Virgin Islands (British) to LME#12. Caribbean Sea	411.84	7.40E+10
100	Bulgaria to LME#26. Mediterranean	3,940.04	2.33E+14
	Bulgaria to LME#62. Black Sea	14,727.43	2.33E+14
104	Myanmar to LME#34. Bay of Bengal	7,494.15	1.21E+15
112	Belarus to LME#23. Baltic Sea	25,270.60	1.18E+15
116	Cambodia to LME#3. California Current	582.67	7.98E+13
120	Cameroon to LME#28. Guinea Current	7,360.45	7.65E+14
124	Canada to LME#2. Gulf of Alaska	1,189.39	9.62E+14
	Canada to LME#63. Hudson Bay	2,882.46	9.62E+14
	Canada to LME#9. Newfoundland-Labrador Shelf	868.21	9.62E+14
	Canada to LME#8. Scotian Shelf	5,829.60	9.62E+14
	Canada to LME#64. Arctic Ocean	83.09	9.62E+14
144	Sri Lanka to LME#34. Bay of Bengal	7,494.15	4.80E+14
152	Chile to LME#13. Humboldt Current	149.59	1.19E+15
156	China, People's Republic of to LME#36. South China Sea	4,836.50	3.04E+16
	China, People's Republic of to LME#47. East China Sea	4,407.80	3.04E+16
	China, People's Republic of to LME#48. Yellow Sea	11,960.27	3.04E+16
170	Colombia to LME#11. Pacific Central-American	751.94	1.72E+15
	Colombia to LME#12. Caribbean Sea	411.84	1.72E+15
178	Congo to LME#28. Guinea Current	7,360.45	1.82E+14
180	Democratic Republic of the Congo to LME#28. Guinea Current	7,360.45	8.97E+14
188	Costa Rica to LME#11. Pacific Central-American	751.94	1.46E+14
	Costa Rica to LME#12. Caribbean Sea	411.84	1.46E+14
191	Croatia to LME#26. Mediterranean	3,940.04	3.89E+14
192	Cuba to LME#12. Caribbean Sea	411.84	3.30E+14
196	Cyprus to LME#26. Mediterranean	3,940.04	5.24E+13
203	Czech Republic to LME#22. North Sea	7,504.06	4.35E+14
204	Benin to LME#28. Guinea Current	7,360.45	1.81E+14
208	Denmark to LME#22. North Sea	7,504.06	2.02E+14
	Denmark to LME#23. Baltic Sea	25,270.60	2.02E+14
	Denmark to LME#60. Faroe Plateau	453.34	2.02E+14
214	Dominican Republic to LME#12. Caribbean Sea	411.84	2.52E+14
218	Ecuador to LME#11. Pacific Central-American	751.94	4.00E+14
222	El Salvador to LME#11. Pacific Central-American	751.94	1.70E+14
226	Equatorial Guinea to LME#28. Guinea Current	7,360.45	1.60E+13
231	Ethiopia to LME#32. Arabian Sea	10,681.20	2.12E+15
	Ethiopia to LME#33. Red Sea	9,870.96	2.12E+15
232	Eritrea to LME#33. Red Sea	9,870.96	3.76E+14
233	Estonia to LME#23. Baltic Sea	25,270.60	8.72E+13
238	Falkland Islands (Malvinas) to LME#14. Patagonian Shelf	2,050.99	1.47E+13
246	Finland to LME#23. Baltic Sea	25,270.60	6.15E+14
250	France to LME#22. North Sea	7,504.06	1.53E+15
	France to LME#24. Celtic-Biscay Shelf	6,179.36	1.53E+15
	France to LME#26. Mediterranean	3,940.04	1.53E+15

262	Djibouti to LME#32. Arabian Sea	10,681.20	1.50E+13
266	Gabon to LME#28. Guinea Current	7,360.45	1.11E+14
268	Georgia to LME#62. Black Sea	14,727.43	3.92E+14
270	Gambia to LME#28. Guinea Current	7,360.45	2.52E+13
276	Germany to LME#22. North Sea	7,504.06	2.05E+15
	Germany to LME#23. Baltic Sea	25,270.60	2.05E+15
288	Ghana to LME#28. Guinea Current	7,360.45	3.76E+14
300	Greece to LME#26. Mediterranean	3,940.04	8.59E+14
320	Guatemala to LME#11. Pacific Central-American	751.94	2.26E+14
	Guatemala to LME#12. Caribbean Sea	411.84	2.26E+14
324	Guinea to LME#28. Guinea Current	7,360.45	3.86E+14
328	Guyana to LME#17. North Brazil Shelf	1,593.52	-4.51E+12
332	Haiti to LME#12. Caribbean Sea	411.84	2.04E+14
340	Honduras to LME#12. Caribbean Sea	411.84	5.30E+14
348	Hungary to LME#62. Black Sea	14,727.43	7.03E+14
352	Iceland to LME#59. Iceland Shelf	534.63	7.25E+13
356	India to LME#32. Arabian Sea	10,681.20	2.51E+16
	India to LME#34. Bay of Bengal	7,494.15	2.51E+16
360	Indonesia to LME#38. Indonesian Sea	2,099.75	4.43E+15
364	Iran, Islamic Republic of to LME#32. Arabian Sea	10,681.20	5.57E+15
368	Iraq to LME#32. Arabian Sea	10,681.20	1.19E+15
372	Ireland to LME#24. Celtic-Biscay Shelf	6,179.36	1.47E+15
376	Israel to LME#26. Mediterranean	3,940.04	2.29E+14
380	Italy to LME#26. Mediterranean	3,940.04	4.38E+14
381	Kosovo to LME#26. Mediterranean	3,940.04	5.95E+13
384	Côte d'Ivoire to LME#28. Guinea Current	7,360.45	5.21E+14
388	Jamaica to LME#12. Caribbean Sea	411.84	5.22E+13
392	Japan to LME#47. East China Sea	4,407.80	5.14E+14
	Japan to LME#49. Kuroshio Current	1,902.20	5.14E+14
	Japan to LME#50. Sea of Japan/East Sea	7,014.70	5.14E+14
	Japan to LME#51. Oyashio Current	883.65	5.14E+14
	Japan to LME#52. Sea of Okhotsk	4,254.46	5.14E+14
400	Jordan to LME#33. Red Sea	9,870.96	1.10E+14
404	Kenya to LME#31. Somali Coastal Current	773.32	1.80E+15
408	Democratic People's Republic of Korea to LME#47. East China Sea	4,407.80	2.66E+14
	Democratic People's Republic of Korea to LME#48. Yellow Sea	11,960.27	2.66E+14
	Democratic People's Republic of Korea to LME#50. Sea of Japan/East Sea	7,014.70	2.66E+14
410	Republic of Korea to LME#47. East China Sea	4,407.80	5.26E+14
	Republic of Korea to LME#48. Yellow Sea	11,960.27	5.26E+14
	Republic of Korea to LME#50. Sea of Japan/East Sea	7,014.70	5.26E+14
418	Lao People's Democratic Republic to LME#36. South China Sea	4,836.50	3.58E+14
422	Lebanon to LME#26. Mediterranean	3,940.04	1.34E+14
428	Latvia to LME#23. Baltic Sea	25,270.60	1.63E+14
430	Liberia to LME#28. Guinea Current	7,360.45	3.52E+13
434	Libyan Arab Jamahiriya to LME#26. Mediterranean	3,940.04	5.20E+14
440	Lithuania to LME#23. Baltic Sea	25,270.60	3.87E+14
450	Madagascar to LME#30. Agulhas Current	2,782.18	1.18E+15
458	Malaysia to LME#34. Bay of Bengal	7,494.15	2.92E+14
	Malaysia to LME#35. Gulf of Thailand	152.23	2.92E+14
	Malaysia to LME#36. South China Sea	4,836.50	2.92E+14
466	Mali to LME#27. Canary Current	1,354.78	6.81E+14
	Mali to LME#28. Guinea Current	7,360.45	6.81E+14
478	Mauritania to LME#27. Canary Current	1,354.78	4.38E+14
484	Mexico to LME#3. California Current	582.67	2.35E+15
	Mexico to LME#4. Gulf of California	5,574.70	2.35E+15
	Mexico to LME#5. Gulf of Mexico	5,590.97	2.35E+15
498	Moldova to LME#62. Black Sea	14,727.43	6.42E+13
499	Montenegro to LME#26. Mediterranean	3,940.04	7.69E+13
504	Morocco to LME#26. Mediterranean	3,940.04	8.93E+14
	Morocco to LME#27. Canary Current	1,354.78	8.93E+14
508	Mozambique to LME#30. Agulhas Current	2,782.18	1.14E+15
512	Oman to LME#32. Arabian Sea	10,681.20	4.75E+12
516	Namibia to LME#29. Benguela Current	1,633.44	5.99E+14
524	Nepal to LME#34. Bay of Bengal	7,494.15	8.73E+14
528	Netherlands to LME#22. North Sea	7,504.06	9.02E+14
540	New Caledonia to LME#40. Northeast Australia	342.13	1.93E+13
554	New Zealand to LME#46. New Zealand Shelf	662.60	2.94E+15
558	Nicaragua to LME#11. Pacific Central-American	751.94	1.16E+14
	Nicaragua to LME#12. Caribbean Sea	411.84	1.16E+14
562	Niger to LME#28. Guinea Current	7,360.45	6.09E+14
566	Nigeria to LME#28. Guinea Current	7,360.45	2.59E+15
578	Norway to LME#21. Norwegian Sea	2,243.94	2.29E+14
	Norway to LME#22. North Sea	7,504.06	2.29E+14
586	Pakistan to LME#32. Arabian Sea	10,681.20	1.02E+16

591	Panama to LME#11. Pacific Central-American	751.94	9.20E+13
	Panama to LME#12. Caribbean Sea	411.84	9.20E+13
600	Paraguay to LME#14. Patagonian Shelf	2,050.99	9.35E+14
604	Peru to LME#13. Humboldt Current	149.59	1.56E+15
608	Philippines to LME#36. South China Sea	4,836.50	8.55E+14
	Philippines to LME#37. Sulu-Celebes Sea	6,096.31	8.55E+14
616	Poland to LME#23. Baltic Sea	25,270.60	2.09E+15
620	Portugal to LME#25. Iberian Coastal	949.59	3.94E+14
624	Guinea-Bissau to LME#28. Guinea Current	7,360.45	6.47E+13
626	Timor-Leste to LME#38. Indonesian Sea	2,099.75	1.22E+13
630	Puerto Rico to LME#12. Caribbean Sea	411.84	8.27E+13
642	Romania to LME#62. Black Sea	14,727.43	1.15E+15
643	Russian Federation to LME#20. Barents Sea	1,754.72	7.71E+14
	Russian Federation to LME#54. Chukchi Sea	1,208.84	7.71E+14
	Russian Federation to LME#56. East Siberian Sea	632.16	7.71E+14
	Russian Federation to LME#57. Laptev Sea	2,402.32	7.71E+14
	Russian Federation to LME#58. Kara Sea	1,837.91	7.71E+14
	Russian Federation to LME#62. Black Sea	14,727.43	7.71E+14
	Russian Federation to LME#64. Arctic Ocean	83.09	7.71E+14
	Russian Federation to LME#50. Sea of Japan/East Sea	7,014.70	7.71E+14
	Russian Federation to LME#51. Oyashio Current	883.65	7.71E+14
	Russian Federation to LME#52. Sea of Okhotsk	4,254.46	7.71E+14
	Russian Federation to LME#53. West Bering Sea	577.86	7.71E+14
682	Saudi Arabia to LME#32. Arabian Sea	10,681.20	8.54E+14
	Saudi Arabia to LME#33. Red Sea	9,870.96	8.54E+14
686	Senegal to LME#27. Canary Current	1,354.78	5.44E+14
688	Serbia to LME#62. Black Sea	14,727.43	2.16E+14
	Serbia to LME#26. Mediterranean	3,940.04	2.16E+14
694	Sierra Leone to LME#28. Guinea Current	7,360.45	1.01E+14
703	Slovakia to LME#62. Black Sea	14,727.43	2.33E+14
704	Viet Nam to LME#36. South China Sea	4,836.50	3.09E+15
705	Slovenia to LME#26. Mediterranean	3,940.04	1.75E+14
706	Somalia to LME#31. Somali Coastal Current	773.32	1.02E+15
	Somalia to LME#32. Arabian Sea	10,681.20	1.02E+15
710	South Africa to LME#29. Benguela Current	1,633.44	1.94E+15
	South Africa to LME#30. Agulhas Current	2,782.18	1.94E+15
716	Zimbabwe to LME#30. Agulhas Current	2,782.18	1.00E+15
724	Spain to LME#25. Iberian Coastal	949.59	2.15E+15
	Spain to LME#26. Mediterranean	3,940.04	2.15E+15
736	Sudan to LME#33. Red Sea	9,870.96	6.28E+15
748	Swaziland to LME#30. Agulhas Current	2,782.18	5.66E+13
752	Sweden to LME#23. Baltic Sea	25,270.60	2.15E+14
	Sweden to LME#22. North Sea	7,504.06	2.15E+14
756	Switzerland to LME#22. North Sea	7,504.06	1.05E+14
	Switzerland to LME#26. Mediterranean	3,940.04	1.05E+14
	Switzerland to LME#62. Black Sea	14,727.43	1.05E+14
760	Syrian Arab Republic to LME#26. Mediterranean	3,940.04	1.03E+15
764	Thailand to LME#34. Bay of Bengal	7,494.15	2.70E+15
768	Togo to LME#28. Guinea Current	7,360.45	1.52E+14
784	United Arab Emirates to LME#32. Arabian Sea	10,681.20	2.35E+12
788	Tunisia to LME#26. Mediterranean	3,940.04	5.58E+14
792	Turkey to LME#26. Mediterranean	3,940.04	4.85E+15
800	Uganda to LME#26. Mediterranean	3,940.04	7.54E+14
804	Ukraine to LME#62. Black Sea	14,727.43	2.10E+15
807	The FYR of Macedonia to LME#26. Mediterranean	3,940.04	1.32E+14
818	Egypt to LME#26. Mediterranean	3,940.04	3.02E+15
826	United Kingdom of GB and NI to LME#22. North Sea	7,504.06	1.41E+15
	United Kingdom of GB and NI to LME#24. Celtic-Biscay Shelf	6,179.36	1.41E+15
834	United Republic of Tanzania: Mainland to LME#30. Agulhas Current	2,782.18	1.87E+15
840	United States to LME#1. East Bering Sea	4,038.15	4.22E+15
	United States to LME#2. Gulf of Alaska	1,189.39	4.22E+15
	United States to LME#3. California Current	582.67	4.22E+15
	United States to LME#4. Gulf of California	5,574.70	4.22E+15
	United States to LME#5. Gulf of Mexico	5,590.97	4.22E+15
	United States to LME#6. Southeast U.S. Continental Shelf	715.14	4.22E+15
	United States to LME#7. Northeast U.S. Continental Shelf	2,316.09	4.22E+15
	United States to LME#10. Insular Pacific-Hawaiian	197.86	4.22E+15
	United States to LME#54. Chukchi Sea	1,208.84	4.22E+15
	United States to LME#55. Beaufort Sea	1,698.62	4.22E+15
858	Uruguay to LME#14. Patagonian Shelf	2,050.99	1.23E+15
862	Venezuela (Bolivarian Republic of) to LME#12. Caribbean Sea	411.84	1.90E+15
887	Yemen to LME#32. Arabian Sea	10,681.20	7.13E+14
894	Zambia to LME#30. Agulhas Current	2,782.18	9.74E+14

**Table 3.19:** Characterisation Factors (CF) and total N emission directly to marine coastal waters (mw) at Country-to-LME scale.

ISO #	Country-to-LME	Emission: N to marine water	
		Resolution scale: Country-to-LME	
		CF "N to marine water" (PAF-)[m <sup>3</sup> -d/kg]	Emission to mw [kg/yr]
8	Albania to LME#26. Mediterranean	23,528.27	n/a
12	Algeria to LME#26. Mediterranean	23,528.27	n/a
24	Angola to LME#29. Benguela Current	9,754.22	n/a
32	Argentina to LME#14. Patagonian Shelf	12,247.66	n/a
36	Australia to LME#39. North Australia	6,542.07	n/a
	Australia to LME#40. Northeast Australia	2,043.07	n/a
	Australia to LME#41. East-Central Australia	2,230.37	n/a
	Australia to LME#42. Southeast Australia	3,455.46	n/a
	Australia to LME#43. Southwest Australia	3,311.26	n/a
	Australia to LME#44. West-Central Australia	2,528.28	n/a
	Australia to LME#45. Northwest Australia	3,185.88	n/a
40	Austria to LME#26. Mediterranean	23,528.27	n/a
44	Bahamas to LME#12. Caribbean Sea	2,459.37	n/a
50	Bangladesh to LME#34. Bay of Bengal	44,752.00	n/a
56	Belgium to LME#22. North Sea	44,811.14	n/a
64	Bhutan to LME#34. Bay of Bengal	44,752.00	n/a
68	Bolivia to LME#13. Humboldt Current	893.27	n/a
70	Bosnia and Herzegovina to LME#26. Mediterranean	23,528.27	n/a
72	Botswana to LME#30. Agulhas Current	16,614.04	n/a
76	Brazil to LME#15. South Brazil Shelf	4,678.20	n/a
	Brazil to LME#16. East Brazil Shelf	2,035.87	n/a
	Brazil to LME#17. North Brazil Shelf	9,515.83	n/a
84	Belize to LME#12. Caribbean Sea	2,459.37	n/a
92	Virgin Islands (British) to LME#12. Caribbean Sea	2,459.37	n/a
100	Bulgaria to LME#26. Mediterranean	23,528.27	n/a
	Bulgaria to LME#62. Black Sea	87,946.16	n/a
104	Myanmar to LME#34. Bay of Bengal	44,752.00	n/a
112	Belarus to LME#23. Baltic Sea	150,905.61	n/a
116	Cambodia to LME#3. California Current	3,479.44	n/a
120	Cameroon to LME#28. Guinea Current	43,953.59	n/a
124	Canada to LME#2. Gulf of Alaska	7,102.53	n/a
	Canada to LME#63. Hudson Bay	17,212.84	n/a
	Canada to LME#9. Newfoundland-Labrador Shelf	5,184.60	n/a
	Canada to LME#8. Scotian Shelf	34,811.98	n/a
	Canada to LME#64. Arctic Ocean	496.21	n/a
144	Sri Lanka to LME#34. Bay of Bengal	44,752.00	n/a
152	Chile to LME#13. Humboldt Current	893.27	n/a
156	China, People's Republic of to LME#36. South China Sea	28,881.56	n/a
	China, People's Republic of to LME#47. East China Sea	26,321.58	n/a
	China, People's Republic of to LME#48. Yellow Sea	71,421.80	n/a
170	Colombia to LME#11. Pacific Central-American	4,490.26	n/a
	Colombia to LME#12. Caribbean Sea	2,459.37	n/a
178	Congo to LME#28. Guinea Current	43,953.59	n/a
180	Democratic Republic of the Congo to LME#28. Guinea Current	43,953.59	n/a
188	Costa Rica to LME#11. Pacific Central-American	4,490.26	n/a
	Costa Rica to LME#12. Caribbean Sea	2,459.37	n/a
191	Croatia to LME#26. Mediterranean	23,528.27	n/a
192	Cuba to LME#12. Caribbean Sea	2,459.37	n/a
196	Cyprus to LME#26. Mediterranean	23,528.27	n/a
203	Czech Republic to LME#22. North Sea	44,811.14	n/a
204	Benin to LME#28. Guinea Current	43,953.59	n/a
208	Denmark to LME#22. North Sea	44,811.14	n/a
	Denmark to LME#23. Baltic Sea	150,905.61	n/a
	Denmark to LME#60. Faroe Plateau	2,707.16	n/a
214	Dominican Republic to LME#12. Caribbean Sea	2,459.37	n/a
218	Ecuador to LME#11. Pacific Central-American	4,490.26	n/a
222	El Salvador to LME#11. Pacific Central-American	4,490.26	n/a
226	Equatorial Guinea to LME#28. Guinea Current	43,953.59	n/a
231	Ethiopia to LME#32. Arabian Sea	63,783.75	n/a
	Ethiopia to LME#33. Red Sea	58,945.34	n/a
232	Eritrea to LME#33. Red Sea	58,945.34	n/a
233	Estonia to LME#23. Baltic Sea	150,905.61	n/a
238	Falkland Islands (Malvinas) to LME#14. Patagonian Shelf	12,247.66	n/a
246	Finland to LME#23. Baltic Sea	150,905.61	n/a
250	France to LME#22. North Sea	44,811.14	n/a
	France to LME#24. Celtic-Biscay Shelf	36,900.59	n/a
	France to LME#26. Mediterranean	23,528.27	n/a

262	Djibouti to LME#32. Arabian Sea	63,783.75	n/a
266	Gabon to LME#28. Guinea Current	43,953.59	n/a
268	Georgia to LME#62. Black Sea	87,946.16	n/a
270	Gambia to LME#28. Guinea Current	43,953.59	n/a
276	Germany to LME#22. North Sea	44,811.14	n/a
	Germany to LME#23. Baltic Sea	150,905.61	n/a
288	Ghana to LME#28. Guinea Current	43,953.59	n/a
300	Greece to LME#26. Mediterranean	23,528.27	n/a
320	Guatemala to LME#11. Pacific Central-American	4,490.26	n/a
	Guatemala to LME#12. Caribbean Sea	2,459.37	n/a
324	Guinea to LME#28. Guinea Current	43,953.59	n/a
328	Guyana to LME#17. North Brazil Shelf	9,515.83	n/a
332	Haiti to LME#12. Caribbean Sea	2,459.37	n/a
340	Honduras to LME#12. Caribbean Sea	2,459.37	n/a
348	Hungary to LME#62. Black Sea	87,946.16	n/a
352	Iceland to LME#59. Iceland Shelf	3,192.60	n/a
356	India to LME#32. Arabian Sea	63,783.75	n/a
	India to LME#34. Bay of Bengal	44,752.00	n/a
360	Indonesia to LME#38. Indonesian Sea	12,538.84	n/a
364	Iran, Islamic Republic of to LME#32. Arabian Sea	63,783.75	n/a
368	Iraq to LME#32. Arabian Sea	63,783.75	n/a
372	Ireland to LME#24. Celtic-Biscay Shelf	36,900.59	n/a
376	Israel to LME#26. Mediterranean	23,528.27	n/a
380	Italy to LME#26. Mediterranean	23,528.27	n/a
381	Kosovo to LME#26. Mediterranean	23,528.27	n/a
384	Côte d'Ivoire to LME#28. Guinea Current	43,953.59	n/a
388	Jamaica to LME#12. Caribbean Sea	2,459.37	n/a
392	Japan to LME#47. East China Sea	26,321.58	n/a
	Japan to LME#49. Kuroshio Current	11,359.16	n/a
	Japan to LME#50. Sea of Japan/East Sea	41,888.91	n/a
	Japan to LME#51. Oyashio Current	5,276.82	n/a
	Japan to LME#52. Sea of Okhotsk	25,405.91	n/a
400	Jordan to LME#33. Red Sea	58,945.34	n/a
404	Kenya to LME#31. Somali Coastal Current	4,617.93	n/a
408	Democratic People's Republic of Korea to LME#47. East China Sea	26,321.58	n/a
	Democratic People's Republic of Korea to LME#48. Yellow Sea	71,421.80	n/a
	Democratic People's Republic of Korea to LME#50. Sea of Japan/East Sea	41,888.91	n/a
410	Republic of Korea to LME#47. East China Sea	26,321.58	n/a
	Republic of Korea to LME#48. Yellow Sea	71,421.80	n/a
	Republic of Korea to LME#50. Sea of Japan/East Sea	41,888.91	n/a
418	Lao People's Democratic Republic to LME#36. South China Sea	28,881.56	n/a
422	Lebanon to LME#26. Mediterranean	23,528.27	n/a
428	Latvia to LME#23. Baltic Sea	150,905.61	n/a
430	Liberia to LME#28. Guinea Current	43,953.59	n/a
434	Libyan Arab Jamahiriya to LME#26. Mediterranean	23,528.27	n/a
440	Lithuania to LME#23. Baltic Sea	150,905.61	n/a
450	Madagascar to LME#30. Agulhas Current	16,614.04	n/a
458	Malaysia to LME#34. Bay of Bengal	44,752.00	n/a
	Malaysia to LME#35. Gulf of Thailand	909.05	n/a
	Malaysia to LME#36. South China Sea	28,881.56	n/a
466	Mali to LME#27. Canary Current	8,090.22	n/a
	Mali to LME#28. Guinea Current	43,953.59	n/a
478	Mauritania to LME#27. Canary Current	8,090.22	n/a
484	Mexico to LME#3. California Current	3,479.44	n/a
	Mexico to LME#4. Gulf of California	33,289.80	n/a
	Mexico to LME#5. Gulf of Mexico	33,386.96	n/a
498	Moldova to LME#62. Black Sea	87,946.16	n/a
499	Montenegro to LME#26. Mediterranean	23,528.27	n/a
504	Morocco to LME#26. Mediterranean	23,528.27	n/a
	Morocco to LME#27. Canary Current	8,090.22	n/a
508	Mozambique to LME#30. Agulhas Current	16,614.04	n/a
512	Oman to LME#32. Arabian Sea	63,783.75	n/a
516	Namibia to LME#29. Benguela Current	9,754.22	n/a
524	Nepal to LME#34. Bay of Bengal	44,752.00	n/a
528	Netherlands to LME#22. North Sea	44,811.14	n/a
540	New Caledonia to LME#40. Northeast Australia	2,043.07	n/a
554	New Zealand to LME#46. New Zealand Shelf	3,956.78	n/a
558	Nicaragua to LME#11. Pacific Central-American	4,490.26	n/a
	Nicaragua to LME#12. Caribbean Sea	2,459.37	n/a
562	Niger to LME#28. Guinea Current	43,953.59	n/a
566	Nigeria to LME#28. Guinea Current	43,953.59	n/a
578	Norway to LME#21. Norwegian Sea	13,399.88	n/a
	Norway to LME#22. North Sea	44,811.14	n/a
586	Pakistan to LME#32. Arabian Sea	63,783.75	n/a

591	Panama to LME#11. Pacific Central-American	4,490.26	n/a
	Panama to LME#12. Caribbean Sea	2,459.37	n/a
600	Paraguay to LME#14. Patagonian Shelf	12,247.66	n/a
604	Peru to LME#13. Humboldt Current	893.27	n/a
608	Philippines to LME#36. South China Sea	28,881.56	n/a
	Philippines to LME#37. Sulu-Celebes Sea	36,404.65	n/a
616	Poland to LME#23. Baltic Sea	150,905.61	n/a
620	Portugal to LME#25. Iberian Coastal	5,670.55	n/a
624	Guinea-Bissau to LME#28. Guinea Current	43,953.59	n/a
626	Timor-Leste to LME#38. Indonesian Sea	12,538.84	n/a
630	Puerto Rico to LME#12. Caribbean Sea	2,459.37	n/a
642	Romania to LME#62. Black Sea	87,946.16	n/a
643	Russian Federation to LME#20. Barents Sea	10,478.46	n/a
	Russian Federation to LME#54. Chukchi Sea	7,218.69	n/a
	Russian Federation to LME#56. East Siberian Sea	3,775.00	n/a
	Russian Federation to LME#57. Laptev Sea	14,345.67	n/a
	Russian Federation to LME#58. Kara Sea	10,975.25	n/a
	Russian Federation to LME#62. Black Sea	87,946.16	n/a
	Russian Federation to LME#64. Arctic Ocean	496.21	n/a
	Russian Federation to LME#50. Sea of Japan/East Sea	41,888.91	n/a
	Russian Federation to LME#51. Oyashio Current	5,276.82	n/a
	Russian Federation to LME#52. Sea of Okhotsk	25,405.91	n/a
	Russian Federation to LME#53. West Bering Sea	3,450.72	n/a
682	Saudi Arabia to LME#32. Arabian Sea	63,783.75	n/a
	Saudi Arabia to LME#33. Red Sea	58,945.34	n/a
686	Senegal to LME#27. Canary Current	8,090.22	n/a
688	Serbia to LME#62. Black Sea	87,946.16	n/a
	Serbia to LME#26. Mediterranean	23,528.27	n/a
694	Sierra Leone to LME#28. Guinea Current	43,953.59	n/a
703	Slovakia to LME#62. Black Sea	87,946.16	n/a
704	Viet Nam to LME#36. South China Sea	28,881.56	n/a
705	Slovenia to LME#26. Mediterranean	23,528.27	n/a
706	Somalia to LME#31. Somali Coastal Current	4,617.93	n/a
	Somalia to LME#32. Arabian Sea	63,783.75	n/a
710	South Africa to LME#29. Benguela Current	9,754.22	n/a
	South Africa to LME#30. Agulhas Current	16,614.04	n/a
716	Zimbabwe to LME#30. Agulhas Current	16,614.04	n/a
724	Spain to LME#25. Iberian Coastal	5,670.55	n/a
	Spain to LME#26. Mediterranean	23,528.27	n/a
736	Sudan to LME#33. Red Sea	58,945.34	n/a
748	Swaziland to LME#30. Agulhas Current	16,614.04	n/a
752	Sweden to LME#23. Baltic Sea	150,905.61	n/a
	Sweden to LME#22. North Sea	44,811.14	n/a
756	Switzerland to LME#22. North Sea	44,811.14	n/a
	Switzerland to LME#26. Mediterranean	23,528.27	n/a
	Switzerland to LME#62. Black Sea	87,946.16	n/a
760	Syrian Arab Republic to LME#26. Mediterranean	23,528.27	n/a
764	Thailand to LME#34. Bay of Bengal	44,752.00	n/a
768	Togo to LME#28. Guinea Current	43,953.59	n/a
784	United Arab Emirates to LME#32. Arabian Sea	63,783.75	n/a
788	Tunisia to LME#26. Mediterranean	23,528.27	n/a
792	Turkey to LME#26. Mediterranean	23,528.27	n/a
800	Uganda to LME#26. Mediterranean	23,528.27	n/a
804	Ukraine to LME#62. Black Sea	87,946.16	n/a
807	The FYR of Macedonia to LME#26. Mediterranean	23,528.27	n/a
818	Egypt to LME#26. Mediterranean	23,528.27	n/a
826	United Kingdom of GB and NI to LME#22. North Sea	44,811.14	n/a
	United Kingdom of GB and NI to LME#24. Celtic-Biscay Shelf	36,900.59	n/a
834	United Republic of Tanzania: Mainland to LME#30. Agulhas Current	16,614.04	n/a
840	United States to LME#1. East Bering Sea	24,114.20	n/a
	United States to LME#2. Gulf of Alaska	7,102.53	n/a
	United States to LME#3. California Current	3,479.44	n/a
	United States to LME#4. Gulf of California	33,289.80	n/a
	United States to LME#5. Gulf of Mexico	33,386.96	n/a
	United States to LME#6. Southeast U.S. Continental Shelf	4,270.51	n/a
	United States to LME#7. Northeast U.S. Continental Shelf	13,830.72	n/a
	United States to LME#10. Insular Pacific-Hawaiian	1,181.53	n/a
	United States to LME#54. Chukchi Sea	7,218.69	n/a
	United States to LME#55. Beaufort Sea	10,143.49	n/a
858	Uruguay to LME#14. Patagonian Shelf	12,247.66	n/a
862	Venezuela (Bolivarian Republic of) to LME#12. Caribbean Sea	2,459.37	n/a
887	Yemen to LME#32. Arabian Sea	63,783.75	n/a
894	Zambia to LME#30. Agulhas Current	16,614.04	n/a



**Table 3.20:** Characterisation Factors (CF) and total N emission to air at country scale.

ISO#	Country	Emission: N to air		Emission to air [kg/yr]				
		Resolution scale:						
		Country	CF "N to air" (PAF-)[m <sup>3</sup> -d/kg]					
8	Albania	7,606.07	2.21E+07		400	Jordan	13,339.20	2.11E+07
12	Algeria	7,211.38	1.76E+08		404	Kenya	1,162.60	4.01E+08
24	Angola	2,490.13	8.24E+08		408	Democratic People's Republic of Korea	10,340.12	1.27E+08
32	Argentina	4,416.45	1.09E+09		410	Republic of Korea	11,305.84	7.80E+07
36	Australia	550.68	1.60E+09		418	Lao People's Democratic Republic	9,051.71	1.62E+08
40	Austria	5,986.51	1.74E+08		422	Lebanon	6,439.34	3.81E+06
44	Bahamas	1,490.85	3.91E+06		428	Latvia	35,828.36	3.93E+07
50	Bangladesh	11,107.20	4.99E+08		430	Liberia	18,505.35	2.34E+07
56	Belgium	14,146.99	9.24E+07		434	Libyan Arab Jamahiriya	6,311.36	5.48E+07
64	Bhutan	9,743.61	3.36E+07		440	Lithuania	33,510.99	5.53E+07
68	Bolivia	214.72	4.31E+08		450	Madagascar	6,968.10	2.44E+08
70	Bosnia and Herzegovina	6,433.01	3.59E+07		458	Malaysia	6,260.37	2.82E+08
72	Botswana	4,689.03	1.14E+08		466	Mali	5,883.41	2.95E+08
76	Brazil	974.66	5.27E+09		478	Mauritania	2,965.74	8.71E+07
84	Belize	1,097.00	1.66E+07		484	Mexico	4,995.20	1.30E+09
92	Virgin Islands (British)	1,692.38	2.47E+04		499	Moldova	19,732.66	5.15E+07
100	Bulgaria	11,041.33	1.52E+08		504	Montenegro	6,004.91	1.49E+07
104	Myanmar	12,033.02	4.63E+08		508	Morocco	3,853.37	1.41E+08
112	Belarus	29,863.38	2.11E+08		512	Mozambique	5,012.94	4.06E+08
116	Cambodia	1,187.57	1.58E+08		516	Oman	21,274.65	4.48E+07
120	Cameroon	10,509.35	3.07E+08		524	Namibia	3,124.29	1.25E+08
124	Canada	1,974.47	1.49E+09		528	Nepal	9,178.18	2.85E+08
144	Sri Lanka	25,932.46	4.68E+07		540	Netherlands	14,615.34	1.28E+08
152	Chile	369.57	9.13E+07		549	New Caledonia	1,692.66	1.01E+06
156	China, People's Republic of	7,937.94	1.48E+10		554	New Zealand	2,518.46	8.06E+07
170	Colombia	809.98	6.12E+08		558	Nicaragua	1,070.72	6.42E+07
178	Congo	10,781.75	1.11E+08		562	Niger	10,873.93	1.56E+08
180	Democratic Republic of the Congo	8,817.57	1.59E+09		566	Nigeria	11,375.19	7.85E+08
188	Costa Rica	1,152.00	3.22E+07		578	Norway	6,640.38	5.16E+07
191	Croatia	6,318.80	6.39E+07		586	Pakistan	13,556.88	7.85E+08
192	Cuba	1,445.79	8.10E+07		591	Panama	1,140.17	2.66E+07
196	Cyprus	8,841.96	3.92E+06		600	Paraguay	3,331.12	2.24E+08
203	Czech Republic	10,857.65	1.76E+08		604	Peru	301.05	3.12E+08
204	Benin	13,077.95	9.12E+07		608	Philippines	11,523.83	1.14E+08
208	Denmark	13,803.73	7.14E+07		616	Poland	35,107.62	5.63E+08
214	Dominican Republic	1,545.87	3.20E+07		620	Portugal	2,497.74	9.22E+07
218	Ecuador	1,521.96	1.27E+08		624	Guinea-Bissau	18,512.85	1.16E+07
222	El Salvador	2,097.28	2.60E+07		626	Timor-Leste	8,710.92	4.28E+06
226	Equatorial Guinea	14,004.93	5.00E+06		630	Puerto Rico	1,612.49	3.68E+06
231	Ethiopia	11,144.71	9.12E+08		642	Romania	20,602.61	3.47E+08
232	Eritrea	15,412.99	5.24E+07		643	Russian Federation	2,591.69	3.74E+09
233	Estonia	38,535.67	2.16E+07		682	Saudi Arabia	10,936.85	4.73E+08
238	Falkland Islands (Malvinas)	9,187.22	4.05E+05		686	Senegal	3,391.52	8.92E+07
246	Finland	38,643.28	1.17E+08		688	Serbia	10,695.46	8.36E+07
250	France	6,843.27	9.60E+08		694	Sierra Leone	17,638.63	2.48E+07
262	Djibouti	18,417.86	8.30E+06		703	Slovakia	19,961.73	9.68E+07
266	Gabon	13,043.97	5.03E+07		704	Viet Nam	10,915.28	3.78E+08
268	Georgia	17,264.22	4.72E+07		705	Slovenia	6,616.68	3.80E+07
270	Gambia	19,658.43	3.96E+06		706	Somalia	7,975.11	2.67E+08
276	Germany	19,927.80	9.95E+08		710	South Africa	3,247.27	7.18E+08
288	Ghana	14,639.52	1.85E+08		716	Zimbabwe	4,303.58	1.86E+08
300	Greece	8,120.22	8.86E+07		724	Spain	3,678.77	6.53E+08
320	Guatemala	1,007.93	7.11E+07		736	Sudan	11,750.93	1.54E+09
324	Guinea	16,406.40	1.57E+08		748	Swaziland	5,466.38	2.47E+07
328	Guyana	3,889.58	1.05E+07		752	Sweden	21,154.72	1.55E+08
332	Haiti	1,517.80	1.15E+07		756	Switzerland	9,455.26	8.26E+07
340	Honduras	1,133.63	9.10E+07		760	Syrian Arab Republic	5,188.23	1.22E+08
348	Hungary	20,356.52	1.55E+08		764	Thailand	13,886.51	3.54E+08
352	Iceland	1,402.27	4.32E+06		768	Togo	14,057.36	4.64E+07
356	India	10,776.02	6.37E+09		784	United Arab Emirates	20,715.44	2.68E+07
360	Indonesia	6,011.18	1.04E+09		788	Tunisia	7,601.66	4.53E+07
364	Iran, Islamic Republic of	13,376.15	7.71E+08		792	Turkey	5,982.32	6.56E+08
368	Iraq	12,920.81	1.34E+08		800	Uganda	4,814.88	2.51E+08
372	Ireland	17,768.49	5.87E+07		804	Ukraine	18,287.34	8.65E+08
376	Israel	6,128.33	5.64E+06		807	The FYR of Macedonia	6,534.89	2.78E+07
380	Italy	7,754.52	4.48E+08		818	Egypt	5,560.13	1.79E+08
381	Kosovo	6,004.91	1.15E+07		826	United Kingdom of GB and NI	10,712.59	4.63E+08
384	Côte d'Ivoire	15,667.52	1.78E+08		834	United Republic of Tanzania: Mainland	4,084.75	6.97E+08
388	Jamaica	1,571.02	3.37E+06		840	United States	1,942.30	8.50E+09
392	Japan	4,767.33	1.49E+08		858	Uruguay	4,786.56	1.74E+08
					862	Venezuela (Bolivarian Republic of)	874.99	5.62E+08
					887	Yemen	18,551.47	1.29E+08
					894	Zambia	3,721.39	6.64E+08

n=143

**Table 3.21:** Characterisation Factors (CF) and total N emission to surface freshwater (sfw) at country scale.

ISO#	Country	Emission: N to freshwater		400	Jordan	27,881.15	2.03E+13				
		Resolution scale: Country						404	Kenya	2,184.28	1.51E+14
		CF "N to freshwater"	Emission to fw								
	(PAF)[m <sup>3</sup> -d/kg]		[kg/yr]	408	Democratic People's Republic of Korea	66,046.07	2.33E+13				
8	Albania	11,128.87	1.47E+13	410	Republic of Korea	66,046.07	4.35E+13				
12	Algeria	11,128.87	1.44E+14	418	Lao People's Democratic Republic	13,660.98	2.52E+13				
24	Angola	4,613.74	7.25E+13	422	Lebanon	11,128.87	1.87E+13				
32	Argentina	5,793.14	5.01E+14	428	Latvia	71,378.35	9.95E+12				
36	Australia	11,019.20	7.38E+13	430	Liberia	20,790.05	6.39E+11				
40	Austria	11,128.87	4.08E+13	434	Libyan Arab Jamahiriya	11,128.87	5.41E+13				
44	Bahamas	1,163.28	1.35E+12	440	Lithuania	71,378.35	2.24E+13				
50	Bangladesh	21,167.69	9.71E+14	450	Madagascar	7,858.44	9.91E+13				
56	Belgium	21,195.67	9.43E+13	458	Malaysia	35,258.65	3.41E+13				
64	Bhutan	21,167.69	3.89E+10	466	Mali	24,616.72	4.51E+13				
68	Bolivia	422.52	1.01E+14	478	Mauritania	3,826.67	6.91E+12				
70	Bosnia and Herzegovina	11,128.87	1.35E+13	484	Mexico	33,183.89	2.62E+14				
72	Botswana	7,858.44	3.42E+13	499	Moldova	41,598.53	9.82E+12				
76	Brazil	7,676.74	6.32E+14	504	Montenegro	11,128.87	7.44E+12				
84	Belize	1,163.28	1.84E+12	508	Morocco	14,955.54	9.90E+13				
92	Virgin Islands (British)	1,163.28	8.07E+08	512	Mozambique	7,858.44	4.58E+13				
100	Bulgaria	52,727.40	1.52E+13	516	Oman	30,169.71	4.62E+10				
104	Myanmar	21,167.69	1.90E+14	524	Namibia	4,613.74	1.13E+13				
112	Belarus	71,378.35	8.36E+13	528	Nepal	21,167.69	1.95E+14				
116	Cambodia	1,645.78	8.64E+11	540	Netherlands	21,195.67	9.78E+13				
120	Cameroon	20,790.05	7.03E+13	999	New Caledonia	966.37	7.98E+11				
124	Canada	30,654.26	6.64E+13	554	New Zealand	1,871.56	2.89E+14				
144	Sri Lanka	21,167.69	7.71E+13	558	Nicaragua	3,287.18	1.34E+13				
152	Chile	422.52	1.22E+14	562	Niger	20,790.05	3.68E+13				
156	China, People's Republic of	59,893.59	3.10E+15	566	Nigeria	20,790.05	2.28E+14				
170	Colombia	3,287.18	1.82E+14	578	Norway	27,533.82	1.63E+13				
178	Congo	20,790.05	6.09E+12	586	Pakistan	30,169.71	2.49E+15				
180	Democratic Republic of the Congo	20,790.05	3.53E+13	591	Panama	3,287.18	6.38E+12				
188	Costa Rica	3,287.18	1.66E+13	600	Paraguay	5,793.14	9.22E+13				
191	Croatia	11,128.87	2.73E+13	604	Peru	422.52	1.29E+14				
192	Cuba	1,163.28	4.79E+13	608	Philippines	30,880.38	1.30E+14				
196	Cyprus	11,128.87	9.33E+12	616	Poland	71,378.35	1.75E+14				
203	Czech Republic	21,195.67	3.01E+13	620	Portugal	2,682.17	4.74E+13				
204	Benin	20,790.05	2.26E+13	624	Guinea-Bissau	20,790.05	6.93E+12				
208	Denmark	93,854.51	2.39E+13	626	Timor-Leste	5,930.87	1.82E+11				
214	Dominican Republic	1,163.28	3.61E+13	630	Puerto Rico	1,163.28	9.16E+12				
218	Ecuador	2,123.90	7.92E+13	642	Romania	41,598.53	1.16E+14				
222	El Salvador	2,123.90	2.29E+13	643	Russian Federation	99,924.93	5.42E+13				
226	Equatorial Guinea	20,790.05	6.68E+11	682	Saudi Arabia	58,050.86	5.93E+13				
231	Ethiopia	58,050.86	1.70E+14	686	Senegal	3,826.67	4.68E+13				
232	Eritrea	27,881.15	2.32E+13	688	Serbia	52,727.40	2.09E+13				
233	Estonia	71,378.35	6.34E+12	694	Sierra Leone	20,790.05	6.57E+12				
238	Falkland Islands (Malvinas)	5,793.14	2.30E+11	703	Slovakia	41,598.53	1.99E+13				
246	Finland	71,378.35	4.20E+13	704	Viet Nam	13,660.98	5.07E+14				
250	France	49,778.52	1.03E+14	705	Slovenia	11,128.87	1.42E+13				
262	Djibouti	30,169.71	1.99E+11	706	Somalia	32,354.00	5.96E+13				
266	Gabon	20,790.05	4.61E+12	710	South Africa	12,472.19	1.25E+14				
268	Georgia	41,598.53	5.73E+13	716	Zimbabwe	7,858.44	6.93E+13				
270	Gambia	20,790.05	2.92E+12	724	Spain	13,811.04	2.06E+14				
276	Germany	92,574.02	1.50E+14	736	Sudan	27,881.15	4.27E+14				
288	Ghana	20,790.05	2.35E+13	748	Swaziland	7,858.44	5.39E+12				
300	Greece	11,128.87	3.93E+13	752	Sweden	92,574.02	1.37E+13				
320	Guatemala	3,287.18	3.31E+13	756	Switzerland	73,923.07	1.16E+13				
324	Guinea	20,790.05	3.02E+13	760	Syrian Arab Republic	11,128.87	1.27E+14				
328	Guyana	4,500.99	3.40E+12	764	Thailand	21,167.69	3.30E+14				
332	Haiti	1,163.28	3.25E+13	768	Togo	20,790.05	9.38E+12				
340	Honduras	1,163.28	5.76E+13	784	United Arab Emirates	30,169.71	2.31E+10				
348	Hungary	41,598.53	5.78E+13	788	Tunisia	11,128.87	6.29E+13				
352	Iceland	1,510.10	2.97E+12	792	Turkey	11,128.87	4.30E+14				
356	India	51,337.41	5.30E+15	800	Uganda	11,128.87	6.18E+13				
360	Indonesia	5,930.87	7.26E+14	804	Ukraine	41,598.53	2.04E+14				
364	Iran, Islamic Republic of	30,169.71	7.24E+14	807	The FYR of Macedonia	11,128.87	8.19E+12				
368	Iraq	30,169.71	1.97E+14	816	Egypt	11,128.87	6.28E+14				
372	Ireland	17,453.98	1.03E+14	828	United Kingdom of GB and NI	38,649.65	9.04E+13				
376	Israel	11,128.87	3.27E+13	834	United Republic of Tanzania: Mainland	7,858.44	1.48E+14				
380	Italy	11,128.87	1.16E+14	840	United States	65,282.46	3.41E+14				
381	Kosovo	11,128.87	5.75E+12	858	Uruguay	5,793.14	1.02E+14				
384	Côte d'Ivoire	20,790.05	3.75E+13	862	Venezuela (Bolivarian Republic of)	1,163.28	2.06E+14				
388	Jamaica	1,163.28	6.59E+12	887	Yemen	30,169.71	7.41E+13				
392	Japan	52,149.38	6.67E+13	894	Zambia	7,858.44	5.20E+13				

n=143

**Table 3.22:** Characterisation Factors (CF) and total N emission to groundwater (gw) at country scale.

		Emission: N to groundwater		400 Jordan 9,870.96 1.10E+14	
		Resolution scale: Country		404 Kenya 773.32 1.80E+15	
ISO#	Country	CF "N to groundwater" (PAF)[m <sup>3</sup> -d/kg]	Emission to gw [kg/yr]	408 Democratic People's Republic of Korea 23,382.77 7.99E+14	410 Republic of Korea 23,382.77 1.58E+15
8	Albania	3,940.04	1.81E+14	418 Lao People's Democratic Republic 4,836.50 3.58E+14	422 Lebanon 3,940.04 1.34E+14
12	Algeria	3,940.04	1.48E+15	428 Latvia 25,270.60 1.63E+14	430 Liberia 7,360.45 3.52E+13
24	Angola	1,633.44	1.56E+15	434 Libyan Arab Jamahiriya 3,940.04 5.20E+14	440 Lithuania 25,270.60 3.87E+14
32	Argentina	2,050.99	5.10E+15	450 Madagascar 2,782.18 1.18E+15	458 Malaysia 12,482.88 8.75E+14
36	Australia	3,901.21	1.38E+16	466 Mali 8,715.24 1.36E+15	478 Mauritania 1,354.78 4.38E+14
40	Austria	3,940.04	3.92E+14	484 Mexico 11,748.33 7.04E+15	499 Moldova 14,727.43 6.42E+13
44	Bahamas	411.84	5.91E+12	504 Montenegro 3,940.04 7.69E+13	508 Morocco 5,294.82 1.79E+15
50	Bangladesh	7,494.15	3.69E+15	512 Mozambique 2,782.18 1.14E+15	516 Oman 10,681.20 4.75E+12
56	Belgium	7,504.06	7.13E+14	524 Namibia 1,633.44 5.99E+14	528 Nepal 7,494.15 8.73E+14
64	Bhutan	7,494.15	3.45E+12	540 Netherlands 7,504.06 9.02E+14	999 New Caledonia 342.13 1.93E+13
68	Bolivia	149.59	1.30E+15	554 New Zealand 662.60 2.94E+15	558 Nicaragua 1,163.78 2.32E+14
70	Bosnia and Herzegovina	3,940.04	1.63E+14	562 Niger 7,360.45 6.09E+14	566 Nigeria 7,360.45 2.59E+15
72	Botswana	2,782.18	7.38E+14	578 Norway 9,748.00 4.57E+14	586 Pakistan 10,681.20 1.02E+16
76	Brazil	2,717.85	1.50E+16	591 Panama 1,163.78 1.84E+14	600 Paraguay 2,050.99 9.35E+14
84	Belize	411.84	1.04E+13	604 Peru 149.59 1.56E+15	608 Philippines 10,932.80 1.71E+15
92	Virgin Islands (British)	411.84	7.40E+10	616 Poland 25,270.60 2.09E+15	620 Portugal 949.59 3.94E+14
100	Bulgaria	18,667.47	4.67E+14	624 Guinea-Bissau 7,360.45 6.47E+13	626 Timor-Leste 2,099.75 1.22E+13
104	Myanmar	7,494.15	1.21E+15	630 Puerto Rico 411.84 8.27E+13	642 Romania 14,727.43 1.15E+15
112	Belarus	25,270.60	1.18E+15	643 Russian Federation 35,377.15 8.48E+15	682 Saudi Arabia 20,552.17 1.71E+15
116	Cambodia	582.67	7.98E+13	686 Senegal 1,354.78 5.44E+14	688 Serbia 18,667.47 4.32E+14
120	Cameroon	7,360.45	7.65E+14	694 Sierra Leone 7,360.45 1.01E+14	703 Slovakia 14,727.43 2.33E+14
124	Canada	10,852.75	4.81E+15	704 Viet Nam 4,836.50 3.09E+15	705 Slovenia 3,940.04 1.75E+14
144	Sri Lanka	7,494.15	4.80E+14	706 Somalia 11,454.52 2.04E+15	710 South Africa 4,415.62 3.89E+15
152	Chile	149.59	1.19E+15	716 Zimbabwe 2,782.18 1.00E+15	724 Spain 4,889.62 4.29E+15
156	China, People's Republic of	21,204.56	9.12E+16	736 Sudan 9,870.96 6.28E+15	748 Swaziland 2,782.18 5.66E+13
170	Colombia	1,163.78	3.43E+15	752 Sweden 32,774.65 4.31E+14	756 Switzerland 26,171.52 3.14E+14
178	Congo	7,360.45	1.82E+14	760 Syrian Arab Republic 3,940.04 1.03E+15	764 Thailand 7,494.15 2.70E+15
180	Democratic Republic of the Congo	7,360.45	8.97E+14	768 Togo 7,360.45 1.52E+14	784 United Arab Emirates 10,681.20 2.35E+12
188	Costa Rica	1,163.78	2.92E+14	788 Tunisia 3,940.04 5.58E+14	792 Turkey 3,940.04 4.85E+15
191	Croatia	3,940.04	3.89E+14	800 Uganda 7,360.45 7.54E+14	804 Ukraine 14,727.43 2.10E+15
192	Cuba	411.84	3.30E+14	807 The FYR of Macedonia 3,940.04 1.32E+14	818 Egypt 3,940.04 3.02E+15
196	Cyprus	3,940.04	5.24E+13	826 United Kingdom of GB and NI 13,683.42 2.81E+15	834 United Republic of Tanzania: Mainland 2,782.18 1.87E+15
203	Czech Republic	7,504.06	4.35E+14	840 United States 23,112.42 4.22E+16	858 Uruguay 2,050.99 1.23E+15
204	Benin	7,360.45	1.81E+14	862 Venezuela (Bolivarian Republic of) 411.84 1.90E+15	887 Yemen 10,681.20 7.13E+14
208	Denmark	33,227.99	6.05E+14	894 Zambia 2,782.18 9.74E+14	
214	Dominican Republic	411.84	2.52E+14		
218	Ecuador	751.94	4.00E+14		
222	El Salvador	751.94	1.70E+14		
226	Equatorial Guinea	7,360.45	1.60E+13		
231	Ethiopia	20,552.17	4.25E+15		
232	Eritrea	9,870.96	3.76E+14		
233	Estonia	25,270.60	8.72E+13		
238	Falkland Islands (Malvinas)	2,050.99	1.47E+13		
246	Finland	25,270.60	6.15E+14		
250	France	17,623.45	4.59E+15		
262	Djibouti	10,681.20	1.50E+13		
266	Gabon	7,360.45	1.11E+14		
268	Georgia	14,727.43	3.92E+14		
270	Gambia	7,360.45	2.52E+13		
276	Germany	32,774.65	4.09E+15		
288	Ghana	7,360.45	3.76E+14		
300	Greece	3,940.04	8.59E+14		
320	Guatemala	1,163.78	4.52E+14		
324	Guinea	7,360.45	3.86E+14		
328	Guyana	1,593.52	-4.51E+12		
332	Haiti	411.84	2.04E+14		
340	Honduras	411.84	5.30E+14		
348	Hungary	14,727.43	7.03E+14		
352	Iceland	534.63	7.25E+13		
356	India	18,175.36	5.02E+16		
360	Indonesia	2,099.75	4.43E+15		
364	Iran, Islamic Republic of	10,681.20	5.57E+15		
368	Iraq	10,681.20	1.19E+15		
372	Ireland	6,179.36	1.47E+15		
376	Israel	3,940.04	2.29E+14		
380	Italy	3,940.04	4.38E+14		
381	Kosovo	3,940.04	5.95E+13		
384	Côte d'Ivoire	7,360.45	5.21E+14		
388	Jamaica	411.84	5.22E+13		
392	Japan	18,462.82	2.57E+15		

n=143

**Table 3.23:** Characterisation Factors (CF) and total N emission directly to marine coastal waters (mw) at country scale.

ISO#	Country	Emission: N to marine water		n/a			
		Resolution scale: Country					
		CF "N to marine water" (PAF-)[m <sup>3</sup> -d/kg]	Emission to mw [kg/yr]				
8	Albania	23,528.27	n/a	400	Jordan	58,945.34	n/a
12	Algeria	23,528.27	n/a	404	Kenya	4,617.93	n/a
24	Angola	9,754.22	n/a	408	Democratic People's Republic of Korea	139,632.29	n/a
32	Argentina	12,247.66	n/a	410	Republic of Korea	139,632.29	n/a
36	Australia	23,296.40	n/a	418	Lao People's Democratic Republic	28,881.56	n/a
40	Austria	23,528.27	n/a	422	Lebanon	23,528.27	n/a
44	Bahamas	2,459.37	n/a	428	Latvia	150,905.61	n/a
50	Bangladesh	44,752.00	n/a	430	Liberia	43,953.59	n/a
56	Belgium	44,811.14	n/a	434	Libyan Arab Jamahiriya	23,528.27	n/a
64	Bhutan	44,752.00	n/a	440	Lithuania	150,905.61	n/a
68	Bolivia	893.27	n/a	450	Madagascar	16,614.04	n/a
70	Bosnia and Herzegovina	23,528.27	n/a	458	Malaysia	74,542.60	n/a
72	Botswana	16,614.04	n/a	466	Mali	52,043.81	n/a
76	Brazil	16,229.90	n/a	478	Mauritania	8,090.22	n/a
84	Belize	2,459.37	n/a	484	Mexico	70,156.21	n/a
92	Virgin Islands (British)	2,459.37	n/a	499	Moldova	87,946.16	n/a
100	Bulgaria	111,474.42	n/a	504	Montenegro	23,528.27	n/a
104	Myanmar	44,752.00	n/a	508	Morocco	31,618.48	n/a
112	Belarus	150,905.61	n/a	512	Mozambique	16,614.04	n/a
116	Cambodia	3,479.44	n/a	516	Oman	63,783.75	n/a
120	Cameroon	43,953.59	n/a	524	Namibia	9,754.22	n/a
124	Canada	64,808.16	n/a	528	Nepal	44,752.00	n/a
144	Sri Lanka	44,752.00	n/a	540	Netherlands	44,811.14	n/a
152	Chile	893.27	n/a	540	Netherlands	44,811.14	n/a
156	China, People's Republic of	126,624.94	n/a	554	New Caledonia	2,043.07	n/a
170	Colombia	6,949.63	n/a	554	New Zealand	3,956.78	n/a
178	Congo	43,953.59	n/a	558	Nicaragua	6,949.63	n/a
180	Democratic Republic of the Congo	43,953.59	n/a	562	Niger	43,953.59	n/a
188	Costa Rica	6,949.63	n/a	566	Nigeria	43,953.59	n/a
191	Croatia	23,528.27	n/a	578	Norway	58,211.03	n/a
192	Cuba	2,459.37	n/a	586	Pakistan	63,783.75	n/a
196	Cyprus	23,528.27	n/a	591	Panama	6,949.63	n/a
203	Czech Republic	44,811.14	n/a	600	Paraguay	12,247.66	n/a
204	Benin	43,953.59	n/a	604	Peru	893.27	n/a
208	Denmark	198,423.91	n/a	608	Philippines	65,286.21	n/a
214	Dominican Republic	2,459.37	n/a	616	Poland	150,905.61	n/a
218	Ecuador	4,490.26	n/a	620	Portugal	5,670.55	n/a
222	El Salvador	4,490.26	n/a	624	Guinea-Bissau	43,953.59	n/a
226	Equatorial Guinea	43,953.59	n/a	626	Timor-Leste	12,538.84	n/a
231	Ethiopia	122,729.09	n/a	630	Puerto Rico	2,459.37	n/a
232	Eritrea	58,945.34	n/a	642	Romania	87,946.16	n/a
233	Estonia	150,905.61	n/a	643	Russian Federation	211,257.79	n/a
238	Falkland Islands (Malvinas)	12,247.66	n/a	682	Saudi Arabia	122,729.09	n/a
246	Finland	150,905.61	n/a	686	Senegal	8,090.22	n/a
250	France	105,240.00	n/a	688	Serbia	111,474.42	n/a
262	Djibouti	63,783.75	n/a	694	Sierra Leone	43,953.59	n/a
266	Gabon	43,953.59	n/a	703	Slovakia	87,946.16	n/a
268	Georgia	87,946.16	n/a	704	Viet Nam	28,881.56	n/a
270	Gambia	43,953.59	n/a	705	Slovenia	23,528.27	n/a
276	Germany	195,716.75	n/a	706	Somalia	68,401.68	n/a
288	Ghana	43,953.59	n/a	710	South Africa	26,368.26	n/a
300	Greece	23,528.27	n/a	716	Zimbabwe	16,614.04	n/a
320	Guatemala	6,949.63	n/a	724	Spain	29,198.82	n/a
324	Guinea	43,953.59	n/a	736	Sudan	58,945.34	n/a
328	Guyana	9,515.83	n/a	748	Swaziland	16,614.04	n/a
332	Haiti	2,459.37	n/a	752	Sweden	195,716.75	n/a
340	Honduras	2,459.37	n/a	756	Switzerland	156,285.57	n/a
348	Hungary	87,946.16	n/a	760	Syrian Arab Republic	23,528.27	n/a
352	Iceland	3,192.60	n/a	764	Thailand	44,752.00	n/a
356	India	108,535.75	n/a	768	Togo	43,953.59	n/a
360	Indonesia	12,538.84	n/a	784	United Arab Emirates	63,783.75	n/a
364	Iran, Islamic Republic of	63,783.75	n/a	788	Tunisia	23,528.27	n/a
368	Iraq	63,783.75	n/a	792	Turkey	23,528.27	n/a
372	Ireland	36,900.59	n/a	800	Uganda	23,528.27	n/a
376	Israel	23,528.27	n/a	804	Ukraine	87,946.16	n/a
380	Italy	23,528.27	n/a	807	The FYR of Macedonia	23,528.27	n/a
381	Kosovo	23,528.27	n/a	818	Egypt	23,528.27	n/a
384	Côte d'Ivoire	43,953.59	n/a	826	United Kingdom of GB and NI	81,711.73	n/a
388	Jamaica	2,459.37	n/a	834	United Republic of Tanzania: Mainland	16,614.04	n/a
392	Japan	110,252.38	n/a	840	United States	138,017.88	n/a
				858	Uruguay	12,247.66	n/a
				862	Venezuela (Bolivarian Republic of)	2,459.37	n/a
				887	Yemen	63,783.75	n/a
				894	Zambia	16,614.04	n/a

n=143

### Appendix 3-XIII: Aggregation of Characterisation Factors

**Table 3.24:** Characterisation Factors (CF) for the emission route “N to air” aggregated to the Region/Continent and Global scales.

Emission: N to air		Resolution scale: Regional/Continental		Emission: N to air		Resolution scale: Global	
Reg. Code	Region/Continent	CF "N to air" (PAF-)[m <sup>3</sup> ·d/kg]	Emission to air [kg/yr]	Reg. Code	Region/Continent	CF "N to air" (PAF-)[m <sup>3</sup> ·d/kg]	Emission to air [kg/yr]
EU27	Europe (EU27)	15,005.26	6.14E+09	w	World default	7,051.54	7.45E+10
EUR51	Europe (EUR51)	10,414.54	1.12E+10	n=1			
WE	Western Europe	14,575.96	6.54E+09				
EE	Eastern Europe	6,747.80	5.57E+09				
ME	Middle East	12,758.75	1.73E+09				
SAS	South Asia	11,095.47	7.52E+09				
SEA	Southeast Asia	8,674.59	2.95E+09				
EAS	East Asia	7,944.22	1.51E+10				
O	Oceania	666.46	1.68E+09				
AF	Africa	7,769.90	1.22E+10				
NA	North America	1,947.11	9.99E+09				
CA	Central America	4,016.43	1.77E+09				
SA	South America	1,968.62	9.41E+09				

n=13

**Table 3.25:** Characterisation Factors (CF) for the emission route “N to surface freshwater (sfw)” aggregated to the Region/Continent and Global scales.

Emission: N to freshwater		Resolution scale: Regional/Continental		Emission: N to freshwater		Resolution scale: Global	
Reg. Code	Region/Continent	CF "N to freshwater" (PAF-)[m <sup>3</sup> ·d/kg]	Emission to fw [kg/yr]	Reg. Code	Region/Continent	CF "N to freshwater" (PAF-)[m <sup>3</sup> ·d/kg]	Emission to fw [kg/yr]
EU27	Europe (EU27)	39,581.60	1.64E+15	w	World default	33,429.28	2.47E+16
EUR51	Europe (EUR51)	36,263.18	2.41E+15	n=1			
WE	Western Europe	38,552.73	1.77E+15				
EE	Eastern Europe	32,724.77	8.39E+14				
ME	Middle East	28,747.94	1.25E+15				
SAS	South Asia	43,770.98	8.06E+15				
SEA	Southeast Asia	14,301.38	1.94E+15				
EAS	East Asia	59,860.93	3.23E+15				
O	Oceania	3,724.61	3.64E+14				
AF	Africa	17,201.61	3.16E+15				
NA	North America	59,638.59	4.08E+14				
CA	Central America	16,794.27	5.47E+14				
SA	South America	9,807.03	3.12E+15				

n=13

**Table 3.26:** Characterisation Factors (CF) for the emission route “N to groundwater (gw)” aggregated to the Region/Continent and Global scales.

		Emission: <b>N to groundwater</b>	
		Resolution scale: <b>Regional/Continental</b>	
Reg. Code	Region/Continent	CF "N to groundwater" (PAF-)[m <sup>3</sup> ·d/kg]	Emission to gw [kg/yr]
EU27	Europe (EU27)	16,289.49	2.86E+16
EUR51	Europe (EUR51)	18,462.31	4.58E+16
WE	Western Europe	15,888.06	3.08E+16
EE	Eastern Europe	22,653.36	1.71E+16
ME	Middle East	11,372.39	1.07E+16
SAS	South Asia	16,702.07	6.18E+16
SEA	Southeast Asia	5,875.60	1.45E+16
EAS	East Asia	21,185.19	9.61E+16
O	Oceania	3,327.48	1.68E+16
AF	Africa	7,012.16	4.52E+16
NA	North America	21,859.17	4.70E+16
CA	Central America	8,620.22	9.84E+15
SA	South America	2,490.05	3.58E+16

n=13

		Emission: <b>N to groundwater</b>	
		Resolution scale: <b>Global</b>	
Reg. Code	Region/Continent	CF "N to groundwater" (PAF-)[m <sup>3</sup> ·d/kg]	Emission to gw [kg/yr]
w	World default	14,850.38	3.86E+17

n=1

**Table 3.27:** Characterisation Factors (CF) for the emission route “N to marine coastal waters (mw)” aggregated to the Region/Continent and Global scales.

		Emission: <b>N to marine water</b>	
		Resolution scale: <b>Regional/Continental</b>	
Reg. Code	Region/Continent	CF "N to marine water" (PAF-)[m <sup>3</sup> ·d/kg]	Emission to mw [kg/yr]
EU27	Europe (EU27)	n/a	n/a
EUR51	Europe (EUR51)	n/a	n/a
WE	Western Europe	n/a	n/a
EE	Eastern Europe	n/a	n/a
ME	Middle East	n/a	n/a
SAS	South Asia	n/a	n/a
SEA	Southeast Asia	n/a	n/a
EAS	East Asia	n/a	n/a
O	Oceania	n/a	n/a
AF	Africa	n/a	n/a
NA	North America	n/a	n/a
CA	Central America	n/a	n/a
SA	South America	n/a	n/a

n=13

		Emission: <b>N to marine water</b>	
		Resolution scale: <b>Global</b>	
Reg. Code	Region/Continent	CF "N to marine water" (PAF-)[m <sup>3</sup> ·d/kg]	Emission to mw [kg/yr]
w	World default	n/a	n/a

n=1

n/a: CF and NR not available as no country emissions of sewage water directly to coastal marine waters are available

### Appendix 3-XIV: Normalisation

**Table 3.28: Normalisation References (NR) and population considered at the Country-to-LME scale.**

ISO 3	Country-to-LME	Resolution scale:		Population
		Country-to-LME	NR	
		(PAP) [m <sup>2</sup> /d]	(person.yr)	(person)
150	Country-to-LME			
1	Libania to LMER26, Mediterranean	7.65E+10	3,14,800	418
12	Algeria to LMER26, Mediterranean	6.80E+10	32,888,449	422
24	Angola to LMER29, Benguela Current	3.70E+10	16,489,021	428
32	Argentina to LMER14, Patagonian Shelf	1.04E+11	38,681,174	434
36	Australia to LMER39, North Australia	9.15E+10	2,914,789	440
	Australia to LMER40, Northeast Australia	2.86E+10	2,914,789	440
	Australia to LMER41, East-Central Australia	3.12E+10	2,914,789	450
	Australia to LMER42, Southeast Australia	4.83E+10	2,914,789	450
	Australia to LMER43, Southwest Australia	4.63E+10	2,914,789	450
	Australia to LMER44, West-Central Australia	3.54E+10	2,914,789	450
	Australia to LMER45, Northwest Australia	4.46E+10	2,914,789	450
40	Austria to LMER26, Mediterranean	7.55E+10	8,232,196	478
44	Bahamas to LMER12, Caribbean Sea	5.75E+09	319,358	484
50	Bangladesh to LMER34, Bay of Bengal	1.68E+11	140,587,922	484
56	Belgium to LMER22, North Sea	2.48E+11	10,414,209	484
64	Bhutan to LMER34, Bay of Bengal	5.50E+09	659,293	499
68	Bolivia to LMER13, Humboldt Current	6.98E+09	9,146,655	499
70	Bosnia and Herzegovina to LMER26, Mediterranean	5.82E+10	3,781,001	504
72	Botswana to LMER30, Agulhas Current	2.62E+11	1,875,673	504
76	Brazil to LMER15, South Brazil Shelf	1.44E+10	61,995,655	508
	Brazil to LMER16, East Brazil Shelf	6.26E+09	61,995,655	512
	Brazil to LMER17, North Brazil Shelf	2.93E+10	61,995,655	516
84	Belize to LMER12, Caribbean Sea	9.26E+09	280,947	524
	Virgin Islands (British) to LMER12, Caribbean Sea	1.95E+08	21,990	524
100	Bulgaria to LMER26, Mediterranean	4.77E+10	3,869,558	540
	Bulgaria to LMER62, Black Sea	1.78E+11	3,869,558	540
104	Myanmar to LMER34, Bay of Bengal	1.08E+11	46,321,162	554
112	Belarus to LMER23, Baltic Sea	9.35E+11	9,825,102	558
116	Cambodia to LMER3, California Current	4.84E+08	13,357,574	562
120	Cameroun to LMER28, Guinea Current	1.18E+11	17,553,589	566
124	Canada to LMER2, Gulf of Alaska	2.61E+10	6,456,683	578
	Canada to LMER63, Hudson Bay	6.33E+10	6,456,683	586
	Canada to LMER9, Newfoundland-Labrador Shelf	1.91E+10	6,456,683	586
	Canada to LMER8, Scotian Shelf	1.28E+11	6,456,683	591
	Canada to LMER64, Arctic Ocean	1.83E+09	6,456,683	591
144	Sri Lanka to LMER34, Bay of Bengal	1.02E+11	19,845,536	600
148	Chile to LMER13, Humboldt Current	4.36E+09	16,301,726	604
156	China, People's Republic of to LMER36, South China Sea	7.02E+10	428,274,369	608
	China, People's Republic of to LMER47, East China Sea	6.39E+10	428,274,369	616
	China, People's Republic of to LMER48, Yellow Sea	1.74E+11	428,274,369	616
170	Colombia to LMER11, Pacific Central-American	1.55E+10	21,520,279	624
	Colombia to LMER12, Caribbean Sea	8.47E+09	21,520,279	624
178	Congo to LMER28, Guinea Current	7.70E+10	3,533,177	626
	Democratic Republic of the Congo to LMER28, Guinea Current	2.53E+10	57,420,522	630
180	Costa Rica to LMER11, Pacific Central-American	1.37E+10	2,154,707	642
	Costa Rica to LMER12, Caribbean Sea	7.52E+09	2,154,707	642
191	Croatia to LMER26, Mediterranean	1.06E+11	4,441,986	643
192	Cuba to LMER12, Caribbean Sea	6.26E+09	11,254,242	643
196	Cyprus to LMER26, Mediterranean	1.67E+11	758,000	643
203	Czech Republic to LMER22, North Sea	9.70E+10	10,220,638	643
204	Benin to LMER28, Guinea Current	8.05E+10	7,613,757	643
208	Denmark to LMER22, North Sea	1.84E+11	1,806,481	643
	Denmark to LMER23, Baltic Sea	6.21E+11	1,806,481	643
	Denmark to LMER60, Faroe Plateau	1.11E+10	1,806,481	643
214	Dominican Republic to LMER12, Caribbean Sea	5.74E+09	9,264,267	643
218	Ecuador to LMER11, Pacific Central-American	1.50E+10	13,426,402	643
222	El Salvador to LMER11, Pacific Central-American	1.03E+10	6,050,513	643
226	Equatorial Guinea to LMER28, Guinea Current	4.39E+10	607,739	643
231	Ethiopia to LMER32, Arabian Sea	1.35E+11	37,131,931	688
	Ethiopia to LMER33, Red Sea	1.25E+11	37,131,931	688
232	Eritrea to LMER33, Red Sea	2.34E+11	4,486,155	688
233	Estonia to LMER23, Baltic Sea	5.14E+11	1,345,857	694
238	Falkland Islands (Malvinas) to LMER14, Patagonian Shelf	1.47E+12	3,140	704
246	Finland to LMER23, Baltic Sea	8.93E+11	5,244,342	704
250	France to LMER22, North Sea	9.40E+10	20,945,479	705
	France to LMER24, Celtic-Biscay Shelf	7.74E+10	20,945,479	705
	France to LMER26, Mediterranean	4.94E+10	20,945,479	705
262	Djibouti to LMER32, Arabian Sea	2.89E+10	808,367	710
266	Gabon to LMER28, Guinea Current	1.34E+11	1,370,729	710
268	Georgia to LMER62, Black Sea	6.72E+11	4,477,006	716
270	Gambia to LMER28, Guinea Current	5.37E+10	1,503,678	724
276	Germany to LMER22, North Sea	7.89E+10	41,270,370	724
	Germany to LMER23, Baltic Sea	2.66E+11	41,270,370	724
280	Ghana to LMER28, Guinea Current	3.65E+10	21,639,806	748
288	Greece to LMER26, Mediterranean	7.19E+10	11,183,114	748
320	Guatemala to LMER11, Pacific Central-American	8.42E+09	6,358,577	756
	Guatemala to LMER12, Caribbean Sea	4.61E+09	6,358,577	756
324	Guinea to LMER28, Guinea Current	1.03E+11	9,041,448	764
328	Guyana to LMER17, North Brazil Shelf	3.28E+10	746,235	764
332	Haiti to LMER12, Caribbean Sea	5.02E+09	9,347,262	764
340	Honduras to LMER12, Caribbean Sea	1.32E+10	6,879,243	764
348	Hungary to LMER62, Black Sea	3.49E+11	10,086,936	764
352	Iceland to LMER59, Iceland Shelf	2.93E+10	296,743	784
356	India to LMER32, Arabian Sea	1.91E+11	570,021,432	784
	India to LMER34, Bay of Bengal	1.34E+11	570,021,432	784
360	Indonesia to LMER38, Indonesian Sea	2.34E+10	227,303,175	800
364	Iran, Islamic Republic of to LMER32, Arabian Sea	4.06E+11	69,732,007	804
372	Iraq to LMER32, Arabian Sea	2.68E+11	27,359,461	807
378	Ireland to LMER24, Celtic-Biscay Shelf	6.72E+11	4,158,042	818
379	Israel to LMER26, Mediterranean	6.98E+10	6,604,572	818
380	Italy to LMER26, Mediterranean	2.52E+10	58,671,206	818
382	Kosovo to LMER26, Mediterranean	3.70E+10	2,415,383	824
384	Côte d'Ivoire to LMER28, Guinea Current	6.63E+10	18,020,946	840
388	Jamaica to LMER12, Caribbean Sea	3.73E+09	2,681,653	840
392	Japan to LMER47, East China Sea	1.63E+10	25,278,589	850
	Japan to LMER49, Kuroshio Current	7.03E+09	25,278,589	850
	Japan to LMER50, Sea of Japan/East Sea	2.59E+10	25,278,589	850
	Japan to LMER51, Oyashio Current	3.26E+09	25,278,589	850
	Japan to LMER52, Sea of Okhotsk	1.57E+10	25,278,589	850
400	Jordan to LMER33, Red Sea	1.28E+11	5,342,002	850
404	Kenya to LMER31, Somali Coastal Current	1.35E+10	35,614,576	850
408	Democratic People's Republic of Korea to LMER47, East China Sea	2.83E+10	7,920,217	858
	Democratic People's Republic of Korea to LMER48, Yellow Sea	7.67E+10	7,920,217	858
	Democratic People's Republic of Korea to LMER50, Sea of Japan/East Sea	4.50E+10	7,920,217	858
410	Republic of Korea to LMER47, East China Sea	2.75E+10	15,681,375	884
	Republic of Korea to LMER48, Yellow Sea	7.47E+10	15,681,375	884
	Republic of Korea to LMER50, Sea of Japan/East Sea	4.38E+10	15,681,375	884
	Lao People's Democratic Republic to LMER36, South China Sea	9.24E+10	9,24E+10	924
	Latavia to LMER26, Mediterranean	6.54E+10	6,54E+10	924
	Latvia to LMER23, Baltic Sea	5.02E+11	2,305,528	924
	Liberia to LMER28, Guinea Current	1.30E+10	3,182,539	924
	Libyan Arab Jamahiriya to LMER26, Mediterranean	1.43E+11	5,769,709	924
	Lithuania to LMER23, Baltic Sea	7.79E+11	3,415,748	924
	Madagascar to LMER30, Agulhas Current	6.35E+10	17,885,967	924
	Malaysia to LMER34, Bay of Bengal	5.49E+10	8,700,080	924
	Malaysia to LMER35, Gulf of Thailand	1.11E+09	8,700,080	924
	Malaysia to LMER36, South China Sea	3.54E+10	8,700,080	924
466	Mali to LMER27, Canary Current	2.83E+10	6,588,321	924
	Mali to LMER28, Guinea Current	1.54E+11	6,588,321	924
478	Mauritania to LMER27, Canary Current	2.98E+10	3,047,249	924
	Mexico to LMER3, California Current	8.23E+09	35,494,586	924
	Mexico to LMER4, Gulf of California	7.87E+10	35,494,586	924
	Mexico to LMER5, Gulf of Mexico	7.89E+10	35,494,586	924
	Moldova to LMER62, Black Sea	1.36E+11	3,766,876	924
	Montenegro to LMER26, Mediterranean	1.84E+11	626,739	924
	Monroco to LMER26, Mediterranean	6.13E+10	15,196,237	924
	Monroco to LMER27, Canary Current	2.11E+10	15,196,237	924
	Mozambique to LMER30, Agulhas Current	3.38E+10	20,700,013	924
	Oman to LMER32, Arabian Sea	2.84E+09	2,429,510	924
	Namibia to LMER29, Benguela Current	7.61E+10	2,079,951	924
	Nepal to LMER34, Bay of Bengal	1.77E+11	27,281,945	924
	Netherlands to LMER22, North Sea	1.72E+11	16,305,457	924
	New Caledonia to LMER40, Northeast Australia	6.44E+09	231,080	924
	New Zealand to LMER46, New Zealand Shelf	1.82E+11	4,134,117	924
	Nicaragua to LMER11, Pacific Central-American	8.73E+09	2,712,168	924
	Nicaragua to LMER12, Caribbean Sea	4.78E+09	2,712,168	924
	Niger to LMER28, Guinea Current	9.63E+10	12,993,884	924
	Nigeria to LMER28, Guinea Current	4.86E+10	139,823,340	924
	Norway to LMER21, Norwegian Sea	4.64E+10	2,311,649	924
	Norway to LMER22, North Sea	1.55E+11	2,311,649	924
	Norway to LMER32, Arabian Sea	5.94E+11	158,645,463	924
	Pakistan to LMER11, Pacific Central-American	8.82E+09	1,619,161	924
	Pakistan to LMER12, Caribbean Sea	4.83E+09	1,619,161	924
	Paraguay to LMER14, Patagonian Shelf	1.26E+11	5,897,816	924
	Peru to LMER13, Humboldt Current	2.89E+09	2,756,709	924
	Philippines to LMER36, South China Sea	3.12E+10	42,773,214	924
	Philippines to LMER37, Sulu-Celebes Sea	3.93E+10	42,773,214	924
	Poland to LMER23, Baltic Sea	4.78E+11	38,165,040	924
	Portugal to LMER35, Iberian Coastal	1.59E+10	10,543,663	924
	Romania to LMER28, Guinea Current	1.43E+11	1,367,695	924
	Timor-Leste to LMER38, Indonesian Sea	3.83E+09	1,010,367	924
	Puerto Rico to LMER12, Caribbean Sea	3.79E+09	3,781,896	924
	Romania to LMER62, Black Sea	3.06E+11	21,771,749	924
	Russian Federation to LMER20, Barents Sea	1.31E+10	13,076,651	924
	Russian Federation to LMER54, Chukchi Sea	9.02E+09	13,076,651	924
	Russian Federation to LMER65, East Siberian Sea	4.71E+09	13,076,651	924
	Russian Federation to LMER57, Laptev Sea	1.79E+10	13,076,651	924
	Russian Federation to LMER58, Kara Sea	1.37E+10	13,076,651	924
	Russian Federation to LMER62, Black Sea	1.10E+11	13,076,651	924
	Russian Federation to LMER64, Arctic Ocean	6.20E+08	13,076,651	924
	Russian Federation to LMER50, Sea of Japan/East Sea	5.23E+10	13,076,651	924
	Russian Federation to LMER51, Oyashio Current	6.59E+09	13,076,651	924
	Russian Federation to LMER52, Sea of Okhotsk	3.17E+10	13,076,651	924
	Russian Federation to LMER53, West Bering Sea	4.31E+09	13,076,651	924
682	Saudi Arabia to LMER32, Arabian Sea	1.57E+11	12,020,558	924
	Saudi Arabia to LMER33, Red Sea	1.45E+11	12,020,558	924
688	Senegal to LMER27, Canary Current	2.38E+10	10,871,908	924
	Serbia to LMER62, Black Sea	2.10E+11	3,720,385	924
	Serbia to LMER26, Mediterranean	5.61E+10	3,720,385	924
694	Sierra Leone to LMER28, Guinea Current	4.21E+10	5,153,435	924
704	Slovakia to LMER62, Black Sea	2.21E+11	5,415,496	924
705	Viet Nam to LMER36, South China Sea	1.03E+11	83,161,145	924
	Slovenia to LMER26, Mediterranean	1.16E+11	2,002,084	924
706	Somalia to LMER31, Somali Coastal Current	3.61E+10	4,179,930	924
	Somalia to LMER32, Arabian Sea	4.98E+11	4,179,930	924
710	South Africa to LMER29, Benguela Current	2.65E+10	23,896,394	924
	South Africa to LMER30, Agulhas Current	4.51E+10	23,896,394	924
716	Zimbabwe to LMER30, Agulhas Current	6.74E+10	12,570,686	924
724	Spain to LMER25, Iberian Coastal	3.24E+11	1,308,651	924
	Spain to LMER26, Mediterranean	1.34E+12	1,512,977	924
	Sudan to LMER33, Red Sea	7.85E+11	38,410,320	924
748	Swaziland to LMER30, Agulhas Current	5.38E+10	1,104,909	924
756	Sweden to LMER23, Baltic Sea	2.39E+11	4,514,673	924
	Sweden to LMER22, North Sea	7.10E+10	4,514,673	924
	Switzerland to LMER22, North Sea	6.75E+10	2,471,669	924
	Switzerland to LMER26, Mediterranean	3.54E+10	2,471,669	924
	Switzerland to LMER62, Black Sea	1.32E+11	2,471,669	924
764	Syrian Arab Republic to LMER26, Mediterranean	1.00E+11	18,484,122	924
764	Thailand to LMER34, Bay of Bengal	1.37E+11	66,698,482	924
784	Togo to LMER28, Guinea Current	5.85E+10	5,408,044	924
788	United Arab Emirates to LMER32, Arabian Sea	8.41E+08	4,069,349	924
788	Tunisia to LMER26, Mediterranean	9.46E+10	9,912,114	924
792	Turkey to LMER26, Mediterranean	1.01E+11	68,143,186	924
800	Ukraine to LMER26, Mediterranean			



**Table 3.29: Normalisation References (NR) and population considered at the Country scale.**

Resolution scale:		Country	Population				
ISO #	Country	NR <sub>i</sub> (PAF-)[m <sup>3</sup> -d/(person.yr)]	[person]				
8	Albania	7.66E+10	3,141,800	400	Jordan	1.28E+11	5,342,002
12	Algeria	6.80E+10	32,888,449	404	Kenya	1.35E+10	35,614,576
24	Angola	3.70E+10	16,489,021	408	Democratic People's Republic of Korea	1.50E+11	23,760,650
32	Argentina	1.04E+11	38,681,174	410	Republic of Korea	1.46E+11	47,044,126
36	Australia	3.26E+11	20,403,520	418	Lao People's Democratic Republic	9.24E+10	5,753,341
40	Austria	7.55E+10	8,232,196	422	Lebanon	6.54E+10	4,052,420
44	Bahamas	5.83E+09	319,358	428	Latvia	5.02E+11	2,305,528
50	Bangladesh	1.68E+11	140,587,922	430	Liberia	1.30E+10	3,182,539
56	Belgium	2.48E+11	10,414,209	434	Libyan Arab Jamahiriya	1.43E+11	5,769,709
64	Bhutan	5.65E+09	659,293	440	Lithuania	7.79E+11	3,415,748
68	Bolivia	6.98E+09	9,146,655	450	Madagascar	6.35E+10	17,885,967
70	Bosnia and Herzegovina	5.82E+10	3,781,001	458	Malaysia	9.14E+10	26,100,241
72	Botswana	2.62E+11	1,875,673	466	Mali	1.82E+11	13,176,642
76	Brazil	4.99E+10	185,986,964	478	Mauritania	2.98E+10	3,047,249
84	Belize	9.26E+09	280,947	484	Mexico	1.66E+11	106,483,757
92	Virgin Islands (British)	1.93E+08	21,990	499	Moldova	1.36E+11	3,766,876
100	Bulgaria	2.26E+11	7,739,115	504	Montenegro	1.84E+11	626,739
104	Myanmar	1.08E+11	46,321,162	508	Morocco	8.24E+10	30,392,473
112	Belarus	9.35E+11	9,825,102	512	Mozambique	3.38E+10	20,770,013
116	Cambodia	4.84E+08	13,357,574	516	Oman	2.84E+09	2,429,510
120	Cameroon	1.18E+11	17,553,589	524	Namibia	7.61E+10	2,079,951
124	Canada	2.38E+11	32,283,413	528	Nepal	1.77E+11	27,281,945
144	Sri Lanka	1.02E+11	19,842,536	540	Netherlands	1.72E+11	16,305,457
152	Chile	4.36E+09	16,301,726	999	New Caledonia	6.44E+09	231,080
156	China, People's Republic of	3.08E+11	1,284,823,106	554	New Zealand	1.82E+11	4,134,117
170	Colombia	2.39E+10	43,040,558	558	Nicaragua	1.35E+10	5,424,336
178	Congo	7.70E+10	3,533,177	562	Niger	9.63E+10	12,993,884
180	Democratic Republic of the Congo	2.53E+10	57,420,522	566	Nigeria	4.86E+10	139,823,340
188	Costa Rica	2.12E+10	4,309,413	578	Norway	2.01E+11	4,623,298
191	Croatia	1.06E+11	4,441,986	586	Pakistan	5.49E+11	158,645,463
192	Cuba	6.26E+09	11,254,242	591	Panama	1.36E+10	3,238,321
196	Cyprus	1.67E+11	758,000	600	Paraguay	1.26E+11	5,897,816
203	Czech Republic	9.70E+10	10,220,638	604	Peru	2.89E+09	27,558,769
204	Benin	8.05E+10	7,633,757	608	Philippines	7.05E+10	85,546,427
208	Denmark	8.16E+11	5,419,444	616	Poland	4.78E+11	38,165,040
214	Dominican Republic	5.74E+09	9,264,267	620	Portugal	1.59E+10	10,543,663
218	Ecuador	1.50E+10	13,426,402	624	Guinea-Bissau	1.43E+11	1,367,695
222	El Salvador	1.03E+10	6,050,513	626	Timor-Leste	3.83E+09	1,010,367
226	Equatorial Guinea	4.39E+10	607,739	630	Puerto Rico	3.79E+09	3,781,986
231	Ethiopia	2.60E+11	74,263,861	642	Romania	3.06E+11	21,771,749
232	Eritrea	2.34E+11	4,486,155	643	Russian Federation	2.64E+11	143,843,159
233	Estonia	5.14E+11	1,345,857	682	Saudi Arabia	3.02E+11	24,041,116
238	Falkland Islands (Malvinas)	1.47E+12	3,140	686	Senegal	2.38E+10	10,871,908
246	Finland	8.93E+11	5,244,342	688	Serbia	2.66E+11	7,440,769
250	France	2.21E+11	62,836,438	694	Sierra Leone	4.21E+10	5,153,435
262	Djibouti	2.89E+10	808,367	703	Slovakia	2.21E+11	5,415,496
266	Gabon	1.34E+11	1,370,729	704	Viet Nam	1.03E+11	83,161,145
268	Georgia	6.72E+11	4,477,006	705	Slovenia	1.16E+11	2,002,084
270	Gambia	5.37E+10	1,503,678	706	Somalia	5.34E+11	8,359,859
276	Germany	3.45E+11	82,540,739	710	South Africa	7.15E+10	47,792,787
288	Ghana	3.65E+10	21,639,806	716	Zimbabwe	6.74E+10	12,570,686
300	Greece	7.19E+10	11,183,114	724	Spain	1.67E+12	3,065,954
320	Guatemala	1.30E+10	12,717,154	736	Sudan	4.85E+11	38,410,320
324	Guinea	1.03E+11	9,041,448	748	Swaziland	5.38E+10	1,104,909
328	Guyana	3.28E+10	746,235	752	Sweden	3.10E+11	9,029,345
332	Haiti	5.02E+09	9,347,262	756	Switzerland	2.35E+11	7,415,007
340	Honduras	1.32E+10	6,879,243	760	Syrian Arab Republic	1.00E+11	18,484,122
348	Hungary	3.49E+11	10,086,936	764	Thailand	1.37E+11	66,698,482
352	Iceland	2.93E+10	296,743	768	Togo	5.85E+10	5,408,044
356	India	3.25E+11	1,140,042,863	784	United Arab Emirates	8.41E+08	4,069,349
360	Indonesia	2.34E+10	227,303,175	788	Tunisia	9.46E+10	9,912,114
364	Iran, Islamic Republic of	4.06E+11	69,732,007	792	Turkey	1.01E+11	68,143,186
368	Iraq	2.68E+11	27,359,461	800	Uganda	3.55E+10	28,431,204
372	Ireland	6.72E+11	4,158,042	804	Ukraine	2.52E+11	46,923,927
376	Israel	6.98E+10	6,604,572	807	The FYR of Macedonia	7.24E+10	2,038,109
380	Italy	2.52E+10	58,671,206	818	Egypt	1.12E+11	74,203,215
381	Kosovo	3.70E+10	2,415,383	826	United Kingdom of GB and NI	1.27E+11	60,202,727
384	Côte d'Ivoire	6.63E+10	18,020,946	834	United Republic of Tanzania: Mainland	4.57E+10	37,758,024
388	Jamaica	3.73E+09	2,681,653	840	United States	4.32E+11	296,820,296
392	Japan	6.82E+10	126,392,944	858	Uruguay	2.60E+11	3,322,529
				862	Venezuela (Bolivarian Republic of)	1.22E+10	26,664,122
				887	Yemen	1.48E+11	20,648,643
				894	Zambia	6.13E+10	11,462,365

n=143

**Table 3.30:** Normalisation References (NR) and population considered at the aggregated scale (region/Continent and global). Inclusion of guidance to application for LCI data for practitioners.

Resolution scale: <b>Regional/Continental</b>				Resolution scale: <b>Global</b>			
		<b>NR<sub>j</sub></b>	<b>Population</b>			<b>NR<sub>j</sub></b>	<b>Population</b>
Reg. Code	Region/Continent	(PAF·d)/(person.yr)	[person]	Reg. Code	Region/Continent	(PAF·d)/(person.yr)	[person]
NA	North America	4.13E+11	329,103,709	w	World default	2.32E+11	6,224,751,905
SAS	South Asia	3.45E+11	1,346,472,100	n=1			
O	Oceania	2.87E+11	25,779,084				
EAS	East Asia	2.80E+11	1,482,020,826				
ME	Middle East	2.69E+11	182,763,202				
EU27	Europe (EU27)	2.56E+11	451,073,067				
EE	Eastern Europe	2.50E+11	276,979,256				
EUR51	Europe (EUR51)	2.49E+11	717,349,231				
WE	Western Europe	2.49E+11	487,293,902				
AF	Africa	1.05E+11	846,679,825				
CA	Central America	1.01E+11	182,054,442				
SA	South America	7.88E+10	511,364,012				
SEA	Southeast Asia	6.67E+10	554,241,547				
n=13							

**Guidance on application:**

Note:	1) $LCI_i [kg] * CF_i [PAF.m^3.d/kg] = IS_i [PAF.m^3.d]$	where i = emission route (air, fw, gw, mw)	Characterisation
NR=1/NF	2) $SUM IS_j = \text{Total Impact Score (IS)}_j [PAF.m^3.d]$	(or Region/Continent, World)	Aggregation
Normalisation Reference	3) $IS_j / NR_j = \text{Normalised Impact Score for country j} [person.yr]$	(or Region/Continent, World)	Normalisation
Normalisation Factor	or 3) $IS_j * NF_j = \text{Normalised Impact Score for country j} [person.yr]$	(or Region/Continent World)	Normalisation

**Table 3.31:** Country groupings used for the aggregation of CFs and NFs.

Countries listing and regional grouping key			Abbreviations used		Other groupings	
Country	Reg. Code	Reg. Name	Reg. Code	Reg. Name	EU27	EUR51
Albania	WE	Western Europe	AF	Africa	Austria	Albania
Algeria	AF	Africa	CA	Central America	Belgium	Andorra*
Angola	AF	Africa	EAS	East Asia	Bulgaria	Armenia*
Argentina	SA	South America	EE	Eastern Europe	Cyprus	Austria
Australia	O	Oceania	EU27	Europe (EU27)	Czech Republic	Azerbaijan*
Austria	WE	Western Europe	EUR51	Europe (EUR51)	Denmark	Belarus
Bahamas	CA	Central America	ME	Middle East	Estonia	Belgium
Bangladesh	SA	South America	NA	North America	Finland	Bosnia and Herzegovina
Belgium	WE	Western Europe	O	Oceania	France	Bulgaria
Bhutan	SAS	South Asia	SA	South America	Germany	Croatia
Bolivia	SA	South America	SAS	South Asia	Greece	Cyprus
Bosnia and Herzegovina	WE	Western Europe	SEA	Southeast Asia	Hungary	Czech Republic
Botswana	AF	Africa	WE	Western Europe	Ireland	Denmark
Brazil	SA	South America			Italy	Estonia
Belize	CA	Central America			Latvia	Finland
Virgin Islands (British)	CA	Central America			Lithuania	France
Bulgaria	WE	Western Europe			Luxembourg*	Georgia
Myanmar	SEA	Southeast Asia			Malta*	Germany
Belarus	EE	Eastern Europe			Netherlands	Greece
Cambodia	SEA	Southeast Asia			Poland	Hungary
Cameroon	AF	Africa			Portugal	Iceland
Canada	NA	North America			Romania	Ireland
Sri Lanka	SAS	South Asia			Slovakia	Italy
Chile	SA	South America			Slovenia	Kazakhstan*
China, People's Republic of	EAS	East Asia			Spain	Kosovo
Colombia	SA	South America			Sweden	Latvia
Congo	AF	Africa			United Kingdom	Liechtenstein*
Democratic Republic of the Congo	AF	Africa			n=27	Lithuania
Costa Rica	CA	Central America				Luxembourg*
Croatia	WE	Western Europe				Macedonia
Cuba	CA	Central America				Malta*
Cyprus	WE	Western Europe				Moldova
Czech Republic	WE	Western Europe				Monaco*
Benin	AF	Africa				Montenegro
Denmark	WE	Western Europe				Netherlands
Dominican Republic	CA	Central America				Norway
Ecuador	SA	South America				Poland
El Salvador	CA	Central America				Portugal
Equatorial Guinea	AF	Africa				Romania
Ethiopia	AF	Africa				Russia
Eritrea	AF	Africa				San Marino*
Estonia	WE	Western Europe				Serbia
Falkland Islands (Malvinas)	SA	South America				Slovakia
Finland	WE	Western Europe				Slovenia
France	WE	Western Europe				Spain
Djibouti	AF	Africa				Sweden
Gabon	AF	Africa				Switzerland
Georgia	EE	Eastern Europe				Turkey
Gambia	AF	Africa				Ukraine
Germany	WE	Western Europe				United Kingdom
Ghana	AF	Africa				Vatican*
Greece	WE	Western Europe				n=51
Guatemala	CA	Central America				
Guinea	AF	Africa				

\* Country CF not available

Guyana	SA	South America
Haiti	CA	Central America
Honduras	CA	Central America
Hungary	WE	Western Europe
Iceland	WE	Western Europe
India	SAS	South Asia
Indonesia	SEA	Southeast Asia
Iran, Islamic Republic of	ME	Middle East
Iraq	ME	Middle East
Ireland	WE	Western Europe
Israel	ME	Middle East
Italy	WE	Western Europe
Kosovo	WE	Western Europe
Côte d'Ivoire	AF	Africa
Jamaica	CA	Central America
Japan	EAS	East Asia
Jordan	ME	Middle East
Kenya	AF	Africa
Democratic People's Republic of Korea	EAS	East Asia
Republic of Korea	EAS	East Asia
Lao People's Democratic Republic	SEA	Southeast Asia
Lebanon	ME	Middle East
Latvia	WE	Western Europe
Liberia	AF	Africa
Libyan Arab Jamahiriya	AF	Africa
Lithuania	WE	Western Europe
Madagascar	AF	Africa
Malaysia	SEA	Southeast Asia
Mali	AF	Africa
Mauritania	AF	Africa
Mexico	CA	Central America
Moldova	EE	Eastern Europe
Montenegro	WE	Western Europe
Morocco	AF	Africa
Mozambique	AF	Africa
Oman	ME	Middle East
Namibia	AF	Africa
Nepal	SAS	South Asia
Netherlands	WE	Western Europe
New Caledonia	O	Oceania
New Zealand	O	Oceania
Nicaragua	CA	Central America
Niger	AF	Africa
Nigeria	AF	Africa
Norway	WE	Western Europe
Pakistan	SAS	South Asia
Panama	CA	Central America
Paraguay	SA	South America
Peru	SA	South America
Philippines	SEA	Southeast Asia
Poland	WE	Western Europe
Portugal	WE	Western Europe
Guinea-Bissau	AF	Africa
Timor-Leste	O	Oceania
Puerto Rico	CA	Central America
Romania	WE	Western Europe
Russian Federation	EE	Eastern Europe
Saudi Arabia	ME	Middle East
Senegal	AF	Africa
Serbia	WE	Western Europe
Sierra Leone	AF	Africa
Slovakia	WE	Western Europe
Viet Nam	SEA	Southeast Asia
Slovenia	WE	Western Europe
Somalia	AF	Africa
South Africa	AF	Africa
Zimbabwe	AF	Africa
Spain	WE	Western Europe
Sudan	AF	Africa
Swaziland	AF	Africa
Sweden	WE	Western Europe
Switzerland	WE	Western Europe
Syrian Arab Republic	ME	Middle East
Thailand	SEA	Southeast Asia
Togo	AF	Africa
United Arab Emirates	ME	Middle East
Tunisia	AF	Africa
Turkey	EE	Eastern Europe
Uganda	AF	Africa
Ukraine	EE	Eastern Europe
The FYR of Macedonia	WE	Western Europe
Egypt	AF	Africa
United Kingdom of GB and NI	WE	Western Europe
United Republic of Tanzania: Mainland	AF	Africa
United States	NA	North America
Uruguay	SA	South America
Venezuela (Bolivarian Republic of)	SA	South America
Yemen	ME	Middle East
Zambia	AF	Africa

### Appendix 3-XV: Uncertainty quantification

**Table 3.32:** Uncertainty quantification on the CFs originated from the N-export splitting scenarios from one country to multiple receiving LME using the extreme values of the possible variation range.

Country	Country-to-LME	emission route:		N to Air		N to sfw		N to gw		N to mw	
		CF (even split)		max range		Country	Country-to-LME	Country	Country-to-LME	Country	Country-to-LME
		PAF.m3.d/kgN	PAF.m3.d/kgN	PAF.m3.d/kgN	PAF.m3.d/kgN	PAF.m3.d/kgN	PAF.m3.d/kgN	PAF.m3.d/kgN	PAF.m3.d/kgN	PAF.m3.d/kgN	PAF.m3.d/kgN
Australia	Australia to LME#39. North Australia	154.64	0 - 1082.49			3,094.40	0 - 3094.4	1,095.53	0 - 2316.14	6,542.07	0 - 6542.07
	Australia to LME#40. Northeast Australia	48.29	0 - 338.06			966.37	0 - 966.37	342.13	0 - 723.32	2,043.07	0 - 2043.07
	Australia to LME#41. East-Central Australia	52.72	0 - 369.05			1,054.97	0 - 1054.97	373.50	0 - 789.63	2,230.37	0 - 2230.37
	Australia to LME#42. Southwest Australia	81.68	0 - 571.76			1,634.43	0 - 1634.43	578.65	0 - 1223.36	3,455.46	0 - 3455.46
	Australia to LME#43. Southeast Australia	78.27	0 - 547.9			1,566.22	0 - 1566.22	554.50	0 - 1172.31	3,311.26	0 - 3311.26
	Australia to LME#44. West-Central Australia	59.76	0 - 418.35			1,195.88	0 - 1195.88	423.39	0 - 895.11	2,528.28	0 - 2528.28
Brazil	Australia to LME#45. Northwest Australia	75.31	0 - 527.16			1,506.92	0 - 1506.92	533.51	0 - 1127.92	3,185.88	0 - 3185.88
	Brazil to LME#15. South Brazil Shelf	280.94	0 - 842.82			2,212.79	0 - 2212.79	783.41	0 - 1656.26	4,678.20	0 - 4678.20
Bulgaria	Brazil to LME#16. East Brazil Shelf	122.26	0 - 366.78			962.97	0 - 962.97	340.93	0 - 720.77	2,035.87	0 - 2035.87
	Brazil to LME#17. North Brazil Shelf	571.46	0 - 1714.37			4,500.99	0 - 4500.99	1,593.52	0 - 3368.96	9,515.83	0 - 9515.83
	Bulgaria to LME#26. Mediterranean	2,330.43	0 - 4660.86			11,128.87	0 - 11128.87	3,940.04	0 - 8329.88	23,528.27	0 - 23528.27
Canada	Bulgaria to LME#2. Black Sea	8,710.90	0 - 17421.8			41,598.53	0 - 41598.53	14,727.43	0 - 31136.22	87,946.16	0 - 87946.16
	Canada to LME#2. Gulf of Alaska	216.39	0 - 1081.94			3,359.50	0 - 3359.5	1,189.39	0 - 2514.56	7,102.53	0 - 7102.53
China, People's Republic of	Canada to LME#63. Hudson Bay	524.41	0 - 2622.07			8,141.68	0 - 8141.68	2,882.46	0 - 6093.99	17,212.84	0 - 17212.84
	Canada to LME#9. Newfoundland-Labrador Shelf	157.96	0 - 789.78			2,452.32	0 - 2452.32	868.21	0 - 1835.54	5,184.60	0 - 5184.60
	Canada to LME#8. Scotian Shelf	1,060.60	0 - 5302.98			16,466.06	0 - 16466.06	5,829.60	0 - 12324.74	34,811.98	0 - 34811.98
	Canada to LME#64. Arctic Ocean	15.12	0 - 75.59			234.71	0 - 234.71	83.09	0 - 175.68	496.21	0 - 496.21
Colombia	China, People's Republic of to LME#36. South China Sea	1,810.54	0 - 5431.63			13,660.98	0 - 13660.98	4,836.50	0 - 10225.15	28,881.56	0 - 28881.56
	China, People's Republic of to LME#47. East China Sea	1,650.06	0 - 4950.19			12,450.11	0 - 12450.11	4,407.80	0 - 9318.82	26,321.58	0 - 26321.58
	China, People's Republic of to LME#48. Yellow Sea	4,477.33	0 - 13432			33,782.51	0 - 33782.51	11,960.27	0 - 25285.98	71,421.80	0 - 71421.80
Costa Rica	Colombia to LME#11. Pacific Central-American	523.34	0 - 1046.67			2,123.90	0 - 2123.9	751.94	0 - 1589.72	4,490.26	0 - 4490.26
	Colombia to LME#12. Caribbean Sea	286.64	0 - 573.28			1,163.28	0 - 1163.28	411.84	0 - 870.71	2,459.37	0 - 2459.37
Denmark	Costa Rica to LME#11. Pacific Central-American	744.33	0 - 1488.65			2,123.90	0 - 2123.9	751.94	0 - 1589.72	4,490.26	0 - 4490.26
	Costa Rica to LME#12. Caribbean Sea	407.68	0 - 815.35			1,163.28	0 - 1163.28	411.84	0 - 870.71	2,459.37	0 - 2459.37
Ethiopia	Denmark to LME#22. North Sea	3,117.37	0 - 9352.11			21,195.67	0 - 21195.67	7,504.06	0 - 15864.81	44,811.14	0 - 44811.14
	Denmark to LME#23. Baltic Sea	10,498.03	0 - 31494.1			71,378.35	0 - 71378.35	25,270.60	0 - 53426.21	150,905.61	0 - 150905.61
	Denmark to LME#60. Faroe Plateau	188.33	0 - 564.99			1,280.49	0 - 1280.49	453.34	0 - 958.44	2,707.16	0 - 2707.16
France	Ethiopia to LME#32. Arabian Sea	5,792.04	0 - 11584.08			30,169.71	0 - 30169.71	10,681.20	0 - 22581.83	63,783.75	0 - 63783.75
	Ethiopia to LME#33. Red Sea	5,352.68	0 - 10705.35			27,881.15	0 - 27881.15	9,870.96	0 - 20868.85	58,945.34	0 - 58945.34
Germany	France to LME#22. North Sea	2,913.86	0 - 8741.58			21,195.67	0 - 21195.67	7,504.06	0 - 15864.81	44,811.14	0 - 44811.14
	France to LME#24. Celtic-Biscay Shelf	2,399.47	0 - 7198.42			17,453.98	0 - 17453.98	6,179.36	0 - 13064.19	36,900.59	0 - 36900.59
	France to LME#26. Mediterranean	1,529.93	0 - 4589.8			11,128.87	0 - 11128.87	3,940.04	0 - 8329.88	23,528.27	0 - 23528.27
Guatemala	Germany to LME#22. North Sea	4,562.65	0 - 9125.3			21,195.67	0 - 21195.67	7,504.06	0 - 15864.81	44,811.14	0 - 44811.14
	Germany to LME#23. Baltic Sea	15,365.15	0 - 30730.29			71,378.35	0 - 71378.35	25,270.60	0 - 53426.21	150,905.61	0 - 150905.61
India	Guatemala to LME#11. Pacific Central-American	651.24	0 - 1302.48			2,123.90	0 - 2123.9	751.94	0 - 1589.72	4,490.26	0 - 4490.26
	Guatemala to LME#12. Caribbean Sea	356.69	0 - 713.38			1,163.28	0 - 1163.28	411.84	0 - 870.71	2,459.37	0 - 2459.37
Japan	India to LME#32. Arabian Sea	6,332.80	0 - 12665.6			30,169.71	0 - 30169.71	10,681.20	0 - 22581.83	63,783.75	0 - 63783.75
	India to LME#34. Bay of Bengal	4,443.22	0 - 8886.44			21,167.69	0 - 21167.69	7,494.15	0 - 15843.87	44,752.00	0 - 44752.00
Morocco	Japan to LME#47. East China Sea	1,138.15	0 - 5690.74			12,450.11	0 - 12450.11	4,407.80	0 - 9318.82	26,321.58	0 - 26321.58
	Japan to LME#49. Kuroshio Current	491.17	0 - 2455.86			5,372.88	0 - 5372.88	1,902.20	0 - 4021.57	11,359.16	0 - 11359.16
	Japan to LME#50. Sea of Japan/East Sea	1,811.28	0 - 9056.41			19,813.46	0 - 19813.46	7,014.70	0 - 14830.24	41,888.91	0 - 41888.91
	Japan to LME#51. Oyashio Current	228.17	0 - 1140.85			2,495.94	0 - 2495.94	883.65	0 - 1868.19	5,276.82	0 - 5276.82
Democratic People's Republic of Korea	Japan to LME#52. Sea of Okhotsk	1,098.56	0 - 5492.78			12,016.99	0 - 12016.99	4,254.46	0 - 8994.64	25,405.91	0 - 25405.91
	Democratic People's Republic of Korea to LME#47. East China Sea	1,949.18	0 - 5847.53			12,450.11	0 - 12450.11	4,407.80	0 - 9318.82	26,321.58	0 - 26321.58
	Democratic People's Republic of Korea to LME#48. Yellow Sea	5,288.96	0 - 15866.89			33,782.51	0 - 33782.51	11,960.27	0 - 25285.98	71,421.80	0 - 71421.80
Republic of Korea	Democratic People's Republic of Korea to LME#50. Sea of Japan/East Sea	3,101.98	0 - 9305.93			19,813.46	0 - 19813.46	7,014.70	0 - 14830.24	41,888.91	0 - 41888.91
	Republic of Korea to LME#47. East China Sea	2,131.22	0 - 6393.67			12,450.11	0 - 12450.11	4,407.80	0 - 9318.82	26,321.58	0 - 26321.58
	Republic of Korea to LME#48. Yellow Sea	5,782.93	0 - 17348.78			33,782.51	0 - 33782.51	11,960.27	0 - 25285.98	71,421.80	0 - 71421.80
Malaysia	Republic of Korea to LME#50. Sea of Japan/East Sea	3,391.69	0 - 10175.07			19,813.46	0 - 19813.46	7,014.70	0 - 14830.24	41,888.91	0 - 41888.91
	Malaysia to LME#34. Bay of Bengal	3,758.44	0 - 11275.32			21,167.69	0 - 21167.69	7,494.15	0 - 15843.87	44,752.00	0 - 44752.00
	Malaysia to LME#35. Gulf of Thailand	76.35	0 - 229.04			429.98	0 - 429.98	152.23	0 - 321.84	909.05	0 - 909.05
	Malaysia to LME#36. South China Sea	2,425.58	0 - 7276.74			13,660.98	0 - 13660.98	4,836.50	0 - 10225.15	28,881.56	0 - 28881.56
Mali	Mali to LME#27. Canary Current	914.58	0 - 1829.15			3,826.67	0 - 3826.67	1,354.78	0 - 2864.24	8,090.22	0 - 8090.22
	Mali to LME#28. Guinea Current	4,968.83	0 - 9937.67			20,790.05	0 - 20790.05	7,360.45	0 - 15561.21	43,953.59	0 - 43953.59
Mexico	Mali to LME#29. Canary Current	247.74	0 - 743.22			1,645.78	0 - 1645.78	582.67	0 - 1231.85	3,479.44	0 - 3479.44
	Mexico to LME#4. Gulf of California	2,370.27	0 - 7110.82			15,746.08	0 - 15746.08	5,574.70	0 - 11875.83	33,289.80	0 - 33289.80
	Mexico to LME#5. Gulf of Mexico	2,377.19	0 - 7131.57			15,792.03	0 - 15792.03	5,590.97	0 - 11820.23	33,386.96	0 - 33386.96
Morocco	Morocco to LME#26. Mediterranean	2,867.41	0 - 5734.82			11,128.87	0 - 11128.87	3,940.04	0 - 8329.88	23,528.27	0 - 23528.27
	Morocco to LME#27. Canary Current	985.96	0 - 1971.92			3,826.67	0 - 3826.67	1,354.78	0 - 2864.24	8,090.22	0 - 8090.22
Nicaragua	Nicaragua to LME#11. Pacific Central-American	691.81	0 - 1383.62			2,123.90	0 - 2123.9	751.94	0 - 1589.72	4,490.26	0 - 4490.26
	Nicaragua to LME#12. Caribbean Sea	378.91	0 - 757.82			1,163.28	0 - 1163.28	411.84	0 - 870.71	2,459.37	0 - 2459.37
Norway	Nicaragua to LME#37. Sulu-Celebes Sea	5,097.96	0 - 10195.91			13,660.98	0 - 13660.98	4,836.50	0 - 10225.15	28,881.56	0 - 28881.56
	Norway to LME#21. Norwegian Sea	1,528.58	0 - 3057.16			6,338.15	0 - 6338.15	2,243.94	0 - 4744.06	13,399.88	0 - 13399.88
Panama	Norway to LME#22. North Sea	5,111.80	0 - 10223.6			21,195.67	0 - 21195.67	7,504.06	0 - 15864.81	44,811.14	0 - 44811.14
	Panama to LME#11. Pacific Central-American	736.68	0 - 1473.36			2,123.90	0 - 2123.9	751.94	0 - 1589.72	4,490.26	0 - 4490.26
Philippines	Panama to LME#12. Caribbean Sea	403.49	0 - 806.97			1,163.28	0 - 1163.28	411.84	0 - 870.71	2,459.37	0 - 2459.37
	Philippines to LME#36. South China Sea	5,097.96	0 - 10195.91			13,660.98	0 - 13660.98	4,836.50	0 - 10225.15	28,881.56	0 - 28881.56
	Philippines to LME#37. Sulu-Celebes Sea	6,425.88	0 - 12851.75			17,219.40	0 - 17219.4	6,096.31	0 - 12888.6	36,404.65	0 - 36404.65
Russian Federation	Russian Federation to LME#20. Barents Sea	128.55	0 - 1414.03			4,956.31	0 - 4956.31	1,754.72	0 - 3709.76	10,478.46	0 - 10478.46
	Russian Federation to LME#54. Chukchi Sea	88.56	0 - 974.14			3,414.44	0 - 3414.44	1,208.84	0 - 2555.69	7,218.69	0 - 7218.69
	Russian Federation to LME#56. East Siberian Sea	46.31	0 - 509.42			1,785.58	0 - 1785.58	632.16	0 - 1336.49	3,775.00	0 - 3775.00
	Russian Federation to LME#57. Laptev Sea	175.99	0 - 1935.9			6,785.50	0 - 6785.5	2,402.32	0 - 5078.9	14,345.67	0 - 14345.67
	Russian Federation to LME#58. Kara Sea	134.64	0 - 1481.07			5,191.29	0 - 5191.29	1,837.91	0 - 3885.65	10,975.25	0 - 10975.25
	Russian Federation to LME#62. Black Sea	1,078.91	0 - 11868.04			41,598.53	0 - 41598.53	14,727.43	0 - 31136.22	87	

Switzerland	Switzerland to LME#22. North Sea	2,711.07	0 - 8133.21	21,195.67	0 - 21195.67	7,504.06	0 - 15864.81	44,811.14	0 - 44811.14
	Switzerland to LME#26. Mediterranean	1,423.46	0 - 4270.37	11,128.87	0 - 11128.87	3,940.04	0 - 8329.88	23,528.27	0 - 23528.27
	Switzerland to LME#62. Black Sea	5,320.73	0 - 15962.2	41,598.53	0 - 41598.53	14,727.43	0 - 31136.22	87,946.16	0 - 87946.16
United Kingdom of GB and NI	United Kingdom of GB and NI to LME#22. North Sea	5,874.84	0 - 11749.68	21,195.67	0 - 21195.67	7,504.06	0 - 15864.81	44,811.14	0 - 44811.14
	United Kingdom of GB and NI to LME#24. Celtic-Biscay Shelf	4,837.75	0 - 9675.5	17,453.98	0 - 17453.98	6,179.36	0 - 13064.19	36,900.59	0 - 36900.59
United States	United States to LME#1. East Bering Sea	339.36	0 - 3393.55	11,406.01	0 - 11406.01	4,038.15	0 - 8537.32	24,114.20	0 - 24114.2
	United States to LME#2. Gulf of Alaska	99.95	0 - 999.53	3,359.50	0 - 3359.5	1,189.39	0 - 2514.56	7,102.53	0 - 7102.53
	United States to LME#3. California Current	48.97	0 - 489.66	1,645.78	0 - 1645.78	582.67	0 - 1231.85	3,479.44	0 - 3479.44
	United States to LME#4. Gulf of California	468.48	0 - 4684.82	15,746.08	0 - 15746.08	5,574.70	0 - 11785.83	33,289.80	0 - 33289.8
	United States to LME#5. Gulf of Mexico	469.85	0 - 4698.49	15,792.03	0 - 15792.03	5,590.97	0 - 11820.23	33,386.96	0 - 33386.96
	United States to LME#6. Southeast U.S. Continental Shelf	60.10	0 - 600.98	2,019.95	0 - 2019.95	715.14	0 - 1511.92	4,270.51	0 - 4270.51
	United States to LME#7. Northeast U.S. Continental Shelf	194.64	0 - 1946.37	6,541.93	0 - 6541.93	2,316.09	0 - 4896.59	13,830.72	0 - 13830.72
	United States to LME#10. Insular Pacific-Hawaiian	16.63	0 - 166.28	558.87	0 - 558.87	197.86	0 - 418.31	1,181.53	0 - 1181.53
	United States to LME#54. Chukchi Sea	101.59	0 - 1015.87	3,414.44	0 - 3414.44	1,208.84	0 - 2555.69	7,218.69	0 - 7218.69
	United States to LME#55. Beaufort Sea	142.75	0 - 1427.48	4,797.87	0 - 4797.87	1,698.62	0 - 3591.17	10,143.49	0 - 10143.49

n=34

n=105

**Table 3.33:** Calculation of the uncertainty range for the combined change in the terms governing the marine-N loss rate (sedimentation rate, denitrification rate, and residence time) of the FF.

ID#	Country-to-LME	emission route	N to Air				N to sw				N to gw				N to mw			
			Estimated CF		Variance		Estimated CF		Variance		Estimated CF		Variance		Estimated CF		Variance	
			PAF.m3.d/gN	PAF.m3.d/gN	%var	%var	PAF.m3.d/gN	PAF.m3.d/gN	%var	%var	PAF.m3.d/gN	PAF.m3.d/gN	%var	%var	PAF.m3.d/gN	PAF.m3.d/gN	%var	%var
8	Albania to LME#26. Mediterranean		7,606.07	3655.27 - 7673.89	0.53	11,128.87	5348.23 - 11228.11	0.53	3,940.04	1893.47 - 3975.17	0.53	23,528.27	11307.04 - 23738.06	0.53				
12	Algeria to LME#26. Mediterranean		7,211.38	3465.59 - 7275.68	0.53	11,128.87	5348.23 - 11228.11	0.53	3,940.04	1893.47 - 3975.17	0.53	23,528.27	11307.04 - 23738.06	0.53				
24	Angola to LME#29. Benguela Current		2,490.13	1242.79 - 12088.99	4.36	4,613.74	2302.67 - 2398.63	4.36	1,633.44	815.23 - 7929.95	4.36	9,754.22	4868.22 - 47354.39	4.36				
36	Argentina to LME#14. Patagonian Shelf		4,416.45	2204.2 - 21440.8	4.36	5,793.14	2891.29 - 28124.32	4.36	2,050.99	1023.62 - 9957.06	4.36	12,247.66	6112.66 - 59459.45	4.36				
36	Australia to LME#39. North Australia		154.64	77.18 - 750.75	4.36	3,094.40	1544.38 - 15022.58	4.36	1,095.53	546.77 - 5318.55	4.36	6,542.07	3265.07 - 31760.21	4.36				
36	Australia to LME#40. Northeast Australia		48.29	7.65 - 234.46	4.70	966.37	153.05 - 4691.52	4.70	342.13	54.19 - 1660.97	4.70	2,043.07	323.58 - 9918.64	4.70				
36	Australia to LME#41. East-Central Australia		52.72	26.31 - 255.95	4.36	1,054.97	526.52 - 5121.61	4.36	373.50	186.41 - 1813.24	4.36	2,230.37	1113.15 - 10827.92	4.36				
36	Australia to LME#42. Southeast Australia		81.68	40.77 - 396.54	4.36	1,634.43	815.73 - 7934.78	4.36	578.65	288.8 - 2809.21	4.36	3,455.46	1724.58 - 16775.44	4.36				
36	Australia to LME#43. Southwest Australia		78.27	39.06 - 379.99	4.36	1,566.22	781.68 - 7603.64	4.36	554.50	276.75 - 2891.97	4.36	3,311.26	1652.61 - 16075.35	4.36				
36	Australia to LME#44. West-Central Australia		59.76	29.83 - 290.14	4.36	1,195.88	596.85 - 5805.7	4.36	423.29	211.31 - 2055.44	4.36	2,528.28	1261.84 - 12274.22	4.36				
36	Australia to LME#45. Northwest Australia		75.31	37.59 - 365.6	4.36	1,506.92	752.09 - 7315.74	4.36	533.51	266.27 - 2500.05	4.36	3,185.88	1590.04 - 15466.69	4.36				
40	Austria to LME#26. Mediterranean		5,986.51	2876.95 - 6039.89	0.53	11,128.87	5348.23 - 11228.11	0.53	3,940.04	1893.47 - 3975.17	0.53	23,528.27	11307.04 - 23738.06	0.53				
44	Bahamas to LME#12. Caribbean Sea		1,490.85	744.29 - 1783.97	0.70	1,163.28	580.75 - 1392.70	0.70	411.84	205.61 - 492.82	0.70	2,459.37	1227.81 - 2942.91	0.70				
59	Bangladesh to LME#34. Bay of Bengal		11,107.20	4096.71 - 12181.63	0.73	21,167.69	7807.36 - 23215.31	0.73	7,494.15	2764.09 - 8219.08	0.73	44,752.00	16506.04 - 49080.99	0.73				
64	Belgium to LME#22. North Sea		14,146.99	2658.3 - 17327.65	1.04	21,195.67	3982.79 - 25961.09	1.04	7,504.06	1410.06 - 9191.10	1.04	44,811.14	8420.27 - 54886.02	1.04				
64	Bhutan to LME#34. Bay of Bengal		9,743.61	3593.77 - 10686.14	0.73	21,167.69	7807.36 - 23215.31	0.73	7,494.15	2764.09 - 8219.08	0.73	44,752.00	16506.04 - 49080.99	0.73				
68	Bolivia to LME#13. Humboldt Current		214.72	106.85 - 1636.23	7.12	422.52	210.26 - 3219.68	7.12	149.59	74.44 - 1139.89	7.12	893.27	444.52 - 4980.99	7.12				
70	Bosnia and Herzegovina to LME#26. Mediterranean		6,433.01	3091.53 - 6490.37	0.53	11,128.87	5348.23 - 11228.11	0.53	3,940.04	1893.47 - 3975.17	0.53	23,528.27	11307.04 - 23738.06	0.53				
70	Botswana to LME#30. Agulhas Current		4,689.03	881.1 - 5743.27	1.04	7,858.44	1476.65 - 9625.25	1.04	2,782.18	522.79 - 3407.7	1.04	16,614.04	11307.04 - 23738.06	1.04				
76	Brazil to LME#15. South Brazil Shelf		280.94	140.21 - 1363.9	4.36	2,212.79	1104.38 - 10742.55	4.36	783.41	390.99 - 3803.26	4.36	4,678.20	2334.83 - 22711.53	4.36				
76	Brazil to LME#16. East Brazil Shelf		122.26	61.02 - 593.55	4.36	962.97	480.61 - 4674.98	4.36	340.93	170.15 - 1655.12	4.36	2,035.87	1016.08 - 9883.68	4.36				
76	Brazil to LME#17. North Brazil Shelf		571.46	34.12 - 819.27	1.37	4,500.99	268.72 - 6452.86	1.37	1,593.52	95.14 - 2284.55	1.37	9,515.83	568.12 - 13642.42	1.37				
84	Brazil to LME#12. Caribbean Sea		1,092.09	547.67 - 1312.69	0.70	1,163.28	580.75 - 1392.70	0.70	411.84	205.61 - 492.82	0.70	2,459.37	1227.81 - 2942.91	0.70				
84	Virgin Islands (British) to LME#12. Caribbean Sea		1,692.38	844.59 - 2025.12	0.70	1,163.28	580.75 - 1392.70	0.70	411.84	205.61 - 492.82	0.70	2,459.37	1227.81 - 2942.91	0.70				
84	Bulgaria to LME#26. Mediterranean		2,330.43	1119.94 - 2351.21	0.53	11,128.87	5348.23 - 11228.11	0.53	3,940.04	1893.47 - 3975.17	0.53	23,528.27	11307.04 - 23738.06	0.53				
84	Bulgaria to LME#62. Black Sea		8,710.90	4186.22 - 8788.57	0.53	41,598.53	19991.12 - 41969.45	0.53	14,727.43	7077.6 - 14858.75	0.53	87,946.16	42264.52 - 89730.33	0.53				
104	Myanmar to LME#34. Bay of Bengal		12,033.02	4438.18 - 13197.01	0.73	21,167.69	7807.36 - 23215.31	0.73	7,494.15	2764.09 - 8219.08	0.73	44,752.00	16506.04 - 49080.99	0.73				
112	Belarus to LME#23. Baltic Sea		29,863.38	15340.83 - 30645.2	0.51	71,378.35	36667.1 - 73247.03	0.51	25,270.60	12981.52 - 25932.18	0.51	150,905.61	77520.3 - 154856.3	0.51				
112	Cambodia to LME#3. California Current		1,187.57	592.7 - 5765.38	4.36	1,645.78	821.39 - 7989.85	4.36	582.67	290.8 - 2828.71	4.36	3,479.44	1736.55 - 16891.86	4.36				
112	Cameroon to LME#28. Guinea Current		10,509.35	5763.78 - 12323.14	0.62	20,790.05	11402.16 - 24378.19	0.62	7,360.45	4036.79 - 8630.79	0.62	43,953.59	24106.04 - 51539.51	0.62				
124	Canada to LME#2. Gulf of Alaska		216.39	108 - 1050.52	4.36	3,359.50	1676.69 - 16309.55	4.36	1,189.39	593.61 - 5774.19	4.36	7,102.53	3544.79 - 34481.09	4.36				
124	Canada to LME#63. Hudson Bay		524.41	220.26 - 654.96	0.83	8,141.68	3419.66 - 10168.43	0.83	2,882.46	1210.69 - 3600.83	0.83	17,212.84	7229.73 - 21497.73	0.83				
124	Canada to LME#9. Newfoundland-Labrador Shelf		157.96	78.83 - 766.43	4.36	2,452.32	1223.92 - 11905.42	4.36	868.21	433.31 - 4214.96	4.36	5,184.60	2587.58 - 25100.45	4.36				
124	Canada to LME#10. Scotian Shelf		1,060.60	527.56 - 1811.52	1.21	16,466.06	8190.5 - 28124.32	1.21	5,829.60	2899.74 - 9957.06	1.21	34,811.98	17316.08 - 59459.45	1.21				
124	Canada to LME#64. Arctic Ocean		15.12	5.66 - 16.84	0.74	234.71	87.9 - 261.38	0.74	83.09	31.12 - 92.54	0.74	496.21	185.84 - 550.6	0.74				
154	Sri Lanka to LME#34. Bay of Bengal		25,932.46	9564.76 - 28440.98	0.73	21,167.69	7807.36 - 23215.31	0.73	7,494.15	2764.09 - 8219.08	0.73	44,752.00	16506.04 - 49080.99	0.73				
154	Chile to LME#13. Humboldt Current		369.57	183.91 - 2816.18	7.12	422.52	210.26 - 3219.68	7.12	149.59	74.44 - 1139.89	7.12	893.27	444.52 - 4980.99	7.12				
156	China, People's Republic of to LME#36. South China Sea		1,810.54	608.89 - 1935.35	0.73	13,660.98	4848.21 - 14602.69	0.73	4,836.50	1626.52 - 5169.89	0.73	28,881.56	9712.93 - 30872.48	0.73				
156	China, People's Republic of to LME#47. East China Sea		1,650.06	740.44 - 1945.07	0.73	12,450.11	5586.79 - 14675.97	0.73	4,407.80	1977.93 - 5195.84	0.73	26,321.58	11811.4 - 31027.42	0.73				
156	China, People's Republic of to LME#48. Yellow Sea		4,477.33	1952.54 - 4823.82	0.64	33,782.51	14732.39 - 36396.82	0.64	11,960.27	5215.82 - 12885.83	0.64	71,421.80	31146.7 - 76948.87	0.64				
170	Colombia to LME#11. Pacific Central-American		523.34	261.19 - 2540.68	4.36	2,123.90	1060.01 - 10311.36	4.36	751.94	375.28 - 3650.48	4.36	4,490.26	2241.04 - 21799.16	4.36				
170	Colombia to LME#12. Caribbean Sea		286.64	143.1 - 342.99	0.70	1,163.28	580.75 - 1392.70	0.70	411.84	205.61 - 492.82	0.70	2,459.37	1227.81 - 2942.91	0.70				
170	Congo to LME#28. Guinea Current		10,781.75	5913.17 - 12642.56	0.62	20,790.05	11402.16 - 24378.19	0.62	7,360.45	4036.79 - 8630.79	0.62	43,953.59	24106.04 - 51539.51	0.62				
170	Democratic Republic of the Congo to LME#28. Guinea Current		8,817.57	4835.94 - 10339.39	0.62	20,790.05	11402.16 - 24378.19	0.62	7,360.45	4036.79 - 8630.79	0.62	43,953.59	24106.04 - 51539.51	0.62				
188	Costa Rica to LME#11. Pacific Central-American		744.33	371.48 - 3615.52	4.36	2,123.90	1060.01 - 10311.36	4.36	751.94	375.28 - 3650.48	4.36	4,490.26	2241.04 - 21799.16	4.36				
188	Costa Rica to LME#12. Caribbean Sea		407.68	203.53 - 487.83	0.70	1,163.28	580.75 - 1392.70	0.70	411.84	205.61 - 492.82	0.70	2,459.37	1227.81 - 2942.91	0.70				
191	Croatia to LME#26. Mediterranean		6,318.80	3036.64 - 6375.15	0.53	11,128.87	5348.23 - 11228.11	0.53	3,940.04	1893.47 - 3975.17	0.53	23,528.27	11307.04 - 23738.06	0.53				
191	Cuba to LME#12. Caribbean Sea		1,445.79	721.79 - 1730.05	0.70	1,163.28	580.75 - 1392.70	0.70	411.84	205.61 - 492.82	0.70	2,459.37	1227.81 - 2942.91	0.70				
196	Cyprus to LME#26. Mediterranean		8,841.96	4249.2 - 8920.8	0.53	11,128.87	5348.23 - 11228.11	0.53	3,940.04	1893.47 - 3975.17	0.53	23,528.27	11307.04 - 23738.06	0.53				
203																		



408	Democratic People's Republic of Korea to LME#47. East China Sea	1,949.18	874.66 - 2297.66	0.73	12,450.11	5886.79 - 14675.97	0.73	4,407.80	1977.93 - 5195.84	0.73	26,321.58	11811.4 - 31027.42	0.73
	Democratic People's Republic of Korea to LME#48. Yellow Sea	5,288.96	2306.49 - 5698.26	0.64	33,782.51	14732.39 - 36396.82	0.64	11,960.27	5215.82 - 12885.83	0.64	71,421.80	31146.7 - 76948.87	0.64
	Democratic People's Republic of Korea to LME#50. Sea of Japan/East Sea	3,101.98	1043.2 - 3315.81	0.73	19,813.46	6663.31 - 21179.28	0.73	7,014.70	2359.06 - 7498.25	0.73	41,888.91	14087.33 - 44776.49	0.73
410	Republic of Korea to LME#47. East China Sea	2,131.22	956.35 - 2512.25	0.73	12,450.11	5886.79 - 14675.97	0.73	4,407.80	1977.93 - 5195.84	0.73	26,321.58	11811.4 - 31027.42	0.73
	Republic of Korea to LME#48. Yellow Sea	5,782.93	2521.91 - 6230.45	0.64	33,782.51	14732.39 - 36396.82	0.64	11,960.27	5215.82 - 12885.83	0.64	71,421.80	31146.7 - 76948.87	0.64
	Republic of Korea to LME#50. Sea of Japan/East Sea	3,391.69	1140.63 - 3625.49	0.73	19,813.46	6663.31 - 21179.28	0.73	7,014.70	2359.06 - 7498.25	0.73	41,888.91	14087.33 - 44776.49	0.73
418	Lao People's Democratic Republic to LME#36. South China Sea	9,051.71	3044.11 - 9675.69	0.73	13,660.98	4594.21 - 14602.69	0.73	4,836.50	1626.52 - 5169.89	0.73	28,881.56	9712.93 - 30872.48	0.73
422	Latvia to LME#26. Mediterranean	6,439.34	3094.57 - 6496.76	0.53	11,128.87	3548.23 - 11228.11	0.53	3,940.04	1893.47 - 3975.17	0.53	23,528.27	11307.04 - 23738.06	0.53
428	Latvia to LME#23. Baltic Sea	35,828.38	18405.05 - 36766.35	0.51	71,378.35	36667.1 - 73247.03	0.51	25,270.60	12981.52 - 25932.18	0.51	150,905.61	77520.3 - 154856.3	0.51
430	Liberia to LME#28. Guinea Current	18,505.35	10149.13 - 21699.17	0.62	20,790.05	11402.16 - 24378.19	0.62	7,360.45	4036.79 - 8630.79	0.62	43,953.59	21406.04 - 51539.51	0.62
434	Libyan Arab Jamahiriya to LME#26. Mediterranean	6,311.36	3033.07 - 6367.64	0.53	11,128.87	3548.23 - 11228.11	0.53	3,940.04	1893.47 - 3975.17	0.53	23,528.27	11307.04 - 23738.06	0.53
440	Lithuania to LME#23. Baltic Sea	33,510.99	17214.61 - 34388.3	0.51	71,378.35	36667.1 - 73247.03	0.51	25,270.60	12981.52 - 25932.18	0.51	150,905.61	77520.3 - 154856.3	0.51
442	Madagascar to LME#30. Agulhas Current	6,968.10	1309.35 - 8534.74	1.04	7,858.44	1476.65 - 9625.25	1.04	2,782.18	522.79 - 3407.14	1.04	16,614.04	3121.87 - 20349.37	1.04
448	Malaysia to LME#34. Bay of Bengal	3,758.44	1386.24 - 4122.01	0.73	21,167.69	7807.36 - 23215.31	0.73	7,494.15	2764.09 - 8219.08	0.73	44,752.00	16506.04 - 49080.99	0.73
450	Malaysia to LME#35. Gulf of Thailand	76.35	38.16 - 2226.49	28.66	429.98	214.92 - 12539.67	28.66	152.23	76.09 - 4439.51	28.66	909.05	454.39 - 26510.94	28.66
452	Malaysia to LME#36. South China Sea	2,425.58	815.73 - 2592.79	0.73	13,660.98	4594.21 - 14602.69	0.73	4,836.50	1626.52 - 5169.89	0.73	28,881.56	9712.93 - 30872.48	0.73
454	Mali to LME#27. Canary Current	914.58	456.45 - 4440.05	4.36	3,826.67	1909.85 - 18577.58	4.36	1,354.78	676.16 - 6577.15	4.36	8,090.22	4037.73 - 39276.06	4.36
456	Mali to LME#28. Guinea Current	4,968.83	2725.12 - 5826.4	0.62	20,790.05	11402.16 - 24378.19	0.62	7,360.45	4036.79 - 8630.79	0.62	43,953.59	21406.04 - 51539.51	0.62
458	Mauritania to LME#27. Canary Current	2,965.74	1480.16 - 14397.94	4.36	3,826.67	1909.85 - 18577.58	4.36	1,354.78	676.16 - 6577.15	4.36	8,090.22	4037.73 - 39276.06	4.36
460	Mexico to LME#3. California Current	247.74	123.64 - 1202.72	4.36	1,645.78	821.39 - 7989.85	4.36	582.67	290.8 - 2828.71	4.36	3,479.44	1736.55 - 16891.86	4.36
462	Mexico to LME#4. Gulf of California	2,370.27	527.14 - 2805.36	0.96	15,746.08	3501.89 - 18636.43	0.96	5,574.70	1239.8 - 6597.99	0.96	33,289.80	7403.58 - 39400.48	0.96
464	Mexico to LME#5. Gulf of Mexico	6,439.34	3094.57 - 6496.76	0.53	11,128.87	3548.23 - 11228.11	0.53	3,940.04	1893.47 - 3975.17	0.53	23,528.27	11307.04 - 23738.06	0.53
466	Moldova to LME#62. Black Sea	19,732.66	9482.98 - 19098.61	0.53	41,598.53	19991.12 - 41969.45	0.53	14,727.43	7077.6 - 14858.75	0.53	87,946.16	42264.52 - 89730.33	0.53
468	Montenegro to LME#26. Mediterranean	6,004.91	2885.8 - 6058.45	0.53	11,128.87	3548.23 - 11228.11	0.53	3,940.04	1893.47 - 3975.17	0.53	23,528.27	11307.04 - 23738.06	0.53
470	Morocco to LME#26. Mediterranean	2,867.41	1378 - 2892.98	0.53	11,128.87	3548.23 - 11228.11	0.53	3,940.04	1893.47 - 3975.17	0.53	23,528.27	11307.04 - 23738.06	0.53
472	Morocco to LME#27. Canary Current	985.96	492.08 - 4786.61	4.36	3,826.67	1909.85 - 18577.58	4.36	1,354.78	676.16 - 6577.15	4.36	8,090.22	4037.73 - 39276.06	4.36
474	Mozambique to LME#30. Agulhas Current	5,012.94	941.96 - 6140.10	1.04	7,858.44	1476.65 - 9625.25	1.04	2,782.18	522.79 - 3407.14	1.04	16,614.04	3121.87 - 20349.37	1.04
476	Oman to LME#23. Arabian Sea	21,274.65	8973 - 23411.65	0.68	30,169.71	17274.66 - 33200.21	0.68	10,681.20	4505.01 - 11754.11	0.68	63,783.75	26902.04 - 70190.72	0.68
478	Namibia to LME#29. Benguela Current	3,124.29	1559.29 - 15167.66	4.36	4,613.74	2302.67 - 22398.63	4.36	1,633.44	815.23 - 7929.95	4.36	9,754.22	4868.22 - 47354.39	4.36
480	Nepal to LME#34. Bay of Bengal	9,178.18	3385.22 - 10066.02	0.73	21,167.69	7807.36 - 23215.31	0.73	7,494.15	2764.09 - 8219.08	0.73	44,752.00	16506.04 - 49080.99	0.73
482	Netherlands to LME#22. North Sea	14,615.34	2746.31 - 17901.3	1.04	21,195.67	3982.79 - 25961.09	1.04	7,504.06	1410.06 - 9191.19	1.04	44,811.14	8420.27 - 54886.02	1.04
484	New Caledonia to LME#40. Northeast Australia	1,692.66	268.08 - 8217.47	4.70	966.37	153.05 - 4691.52	4.70	342.13	54.19 - 1660.97	4.70	2,043.07	323.58 - 9918.64	4.70
486	New Zealand to LME#46. New Zealand Shelf	2,518.46	1256.93 - 12226.52	4.36	1,871.56	934.07 - 9085.97	4.36	662.60	330.7 - 3216.77	4.36	3,956.78	1974.78 - 19209.23	4.36
488	Nicaragua to LME#11. Pacific Central-American	691.81	345.27 - 3358.57	4.36	2,123.90	1060.01 - 10311	4.36	751.94	375.28 - 3650.48	4.36	4,490.26	2240.14 - 21799.16	4.36
490	Nicaragua to LME#12. Caribbean Sea	378.91	189.17 - 453.41	0.70	1,163.28	580.75 - 1392	0.70	411.84	205.61 - 492.82	0.70	2,459.37	1227.81 - 2942.91	0.70
492	Niger to LME#28. Guinea Current	10,873.93	5963.73 - 12750.65	0.62	20,790.05	11402.16 - 24378.19	0.62	7,360.45	4036.79 - 8630.79	0.62	43,953.59	21406.04 - 51539.51	0.62
494	Nigeria to LME#28. Guinea Current	11,375.19	6238.05 - 13338.43	0.62	20,790.05	11402.16 - 24378.19	0.62	7,360.45	4036.79 - 8630.79	0.62	43,953.59	21406.04 - 51539.51	0.62
496	Norway to LME#21. Norwegian Sea	1,528.58	287.23 - 3098.22	1.84	6,338.15	1190.07 - 12846.52	1.84	2,243.94	421.65 - 4548.15	1.84	13,399.88	2417.92 - 27159.67	1.84
498	Norway to LME#22. North Sea	5,111.80	960.54 - 6261.08	1.04	21,195.67	3982.79 - 25961.09	1.04	7,504.06	1410.06 - 9191.19	1.04	44,811.14	8420.27 - 54886.02	1.04
500	Pakistan to LME#32. Arabian Sea	13,556.88	5717.88 - 14918.65	0.68	30,169.71	17274.66 - 33200.21	0.68	10,681.20	4505.01 - 11754.11	0.68	63,783.75	26902.04 - 70190.72	0.68
502	Panama to LME#11. Pacific Central-American	736.68	367.67 - 3576.4	4.36	2,123.90	1060.01 - 10311	4.36	751.94	375.28 - 3650.48	4.36	4,490.26	2240.14 - 21799.16	4.36
504	Panama to LME#12. Caribbean Sea	403.49	201.44 - 482.82	0.70	1,163.28	580.75 - 1392	0.70	411.84	205.61 - 492.82	0.70	2,459.37	1227.81 - 2942.91	0.70
506	Paraguay to LME#14. Patagonian Shelf	3,331.12	1662.52 - 16171.79	4.36	5,793.14	2891.29 - 28124.32	4.36	2,050.99	1023.62 - 9957.06	4.36	12,247.66	6112.66 - 59459.45	4.36
508	Peru to LME#13. Humboldt Current	301.05	149.81 - 2294.06	7.12	422.52	210.26 - 3219.68	7.12	149.59	74.44 - 1139.89	7.12	893.27	444.52 - 6806.93	7.12
510	Philippines to LME#36. South China Sea	5,097.96	1714.45 - 5449.38	0.73	13,660.98	4594.21 - 14602.69	0.73	4,836.50	1626.52 - 5169.89	0.73	28,881.56	9712.93 - 30872.48	0.73
512	Philippines to LME#37. Sulu-Celebes Sea	6,425.88	2161.04 - 6623	0.69	17,219.40	5790.92 - 17747.64	0.69	6,096.31	2050.2 - 6283.33	0.69	36,404.65	17224.96 - 37521.44	0.69
514	Poland to LME#23. Baltic Sea	35,107.62	18034.81 - 36026.74	0.51	71,378.35	36667.1 - 73247.03	0.51	25,270.60	12981.52 - 25932.18	0.51	150,905.61	77520.3 - 154856.3	0.51
516	Portugal to LME#25. Iberian Coastal	2,497.74	1246.59 - 12125.94	4.36	2,682.17	1338.64 - 13021.3	4.36	949.59	473.93 - 4610.03	4.36	5,670.55	2830.11 - 27529.18	4.36
518	Guinea-Bissau to LME#28. Guinea Current	18,512.85	10153.24 - 21707.97	0.62	20,790.05	11402.16 - 24378.19	0.62	7,360.45	4036.79 - 8630.79	0.62	43,953.59	21406.04 - 51539.51	0.62
520	Timor-Leste to LME#38. Indonesian Sea	8,710.92	5355.98 - 16705.81	1.30	9,930.87	3646.64 - 11374.23	1.30	2,099.75	1291.05 - 4026.9	1.30	12,538.84	7709.6 - 24046.99	1.30
522	Puerto Rico to LME#12. Caribbean Sea	1,612.49	805.01 - 12929.52	0.70	1,163.28	580.75 - 1392	0.70	411.84	205.61 - 492.82	0.70	2,459.37	1227.81 - 2942.91	0.70
524	Romania to LME#62. Black Sea	20,602.61	9901.06 - 20798.31	0.53	41,598.53	19991.12 - 41969.45	0.53	14,727.43	7077.6 - 14858.75	0.53	87,946.16	42264.52 - 89730.33	0.53
526	Russian Federation to LME#20. Barents Sea	128.55	24.15 - 260.55	1.84	4,956.31	911.32 - 10045.74	1.84	1,754.72	329.72 - 3556.57	1.84	10,478.46	1968.96 - 21238.35	1.84
528	Russian Federation to LME#54. Chukchi Sea	88.56	40.99 - 104.16	0.71	3,414.44	1580.39 - 4015.92	0.71	1,208.84	559.52 - 1421.79	0.71	7,218.69	3341.2 - 8490.33	0.71
530	Russian Federation to LME#55. East Siberian Sea	46.31	21.44 - 54.47	0.71	1,785.58	826.46 - 2100.12	0.71	632.16	292.6 - 743.52	0.71	3,775.00	1747.27 - 4440	0.71
532	Russian Federation to LME#57. Laptev Sea	175.99	81.46 - 206.99	0.71	6,785.50	3140.69 - 7980.83	0.71	2,402.32	1111.92 - 2825.51	0.71			

**Table 3.34:** Calculation of the uncertainty range for the available BGE data values (del Giorgio & Cole 1998) influencing the oxygen consumption with the degradation of organic matter, expressed in the XF.

50# Country-LME	emission route	N to Air			N to swf			N to gw			N to wr		
		Estimated CF	Var range		Estimated CF	Var range		Estimated CF	Var range		Estimated CF	Var range	
		PAF.m3.d/kgN	PAF.m3.d/kgN	%var	PAF.m3.d/kgN	PAF.m3.d/kgN	%var	PAF.m3.d/kgN	PAF.m3.d/kgN	%var	PAF.m3.d/kgN	PAF.m3.d/kgN	%var
8	Albania to LME#26. Mediterranean	7,606.07	3189.73 - 10186.56	0.92	11,128.87	4667.07 - 14904.53	0.92	3,940.04	1652.32 - 5276.76	0.92	23,528.27	9866.96 - 31510.63	0.92
12	Algeria to LME#26. Mediterranean	7,211.38	3024.21 - 9657.96	0.92	11,128.87	4667.07 - 14904.53	0.92	3,940.04	1652.32 - 5276.76	0.92	23,528.27	9866.96 - 31510.63	0.92
24	Angola to LME#29. Benguela Current	2,490.13	1044.28 - 3334.95	0.92	4,613.74	1934.85 - 6179.03	0.92	1,633.44	685.01 - 2187.61	0.92	9,754.22	4090.59 - 13063.5	0.92
32	Argentina to LME#14. Patagonian Shelf	4,416.45	1852.11 - 5914.8	0.92	5,793.14	2429.45 - 7758.56	0.92	2,050.99	860.12 - 2746.82	0.92	12,247.66	5136.26 - 16402.88	0.92
36	Australia to LME#39. North Australia	154.64	64.85 - 207.11	0.92	3,094.40	1297.69 - 4144.23	0.92	1,095.53	459.43 - 1467.21	0.92	6,542.07	2740.53 - 9761.58	0.92
36	Australia to LME#40. Northeast Australia	48.29	20.25 - 64.68	0.92	966.37	405.26 - 1294.23	0.92	342.13	143.48 - 458.21	0.92	2,043.07	856.8 - 2736.22	0.92
36	Australia to LME#41. East-Central Australia	52.72	22.11 - 70.61	0.92	1,054.97	442.42 - 1412.88	0.92	373.50	156.63 - 500.21	0.92	2,230.37	935.34 - 2987.06	0.92
36	Australia to LME#42. Southeast Australia	81.68	34.25 - 109.39	0.92	1,634.43	685.43 - 2188.94	0.92	578.65	242.67 - 774.97	0.92	3,455.46	1449.1 - 4627.78	0.92
36	Australia to LME#43. Southwest Australia	78.27	32.82 - 104.83	0.92	1,566.22	656.42 - 2097.59	0.92	554.50	232.54 - 742.63	0.92	3,311.26	1388.63 - 4434.65	0.92
36	Australia to LME#44. West-Central Australia	59.76	25.06 - 80.04	0.92	1,195.88	501.51 - 1601.16	0.92	423.39	177.55 - 567.03	0.92	2,528.28	1060.28 - 3386.05	0.92
36	Australia to LME#45. Northwest Australia	75.31	31.58 - 100.86	0.92	1,506.92	631.95 - 2018.17	0.92	533.51	223.73 - 714.51	0.92	3,185.88	1338.05 - 4266.74	0.92
40	Austria to LME#26. Mediterranean	5,986.51	2510.54 - 8017.54	0.92	11,128.87	4667.07 - 14904.53	0.92	3,940.04	1652.32 - 5276.76	0.92	23,528.27	9866.96 - 31510.63	0.92
40	Bahamas to LME#12. Caribbean Sea	1,490.85	625.21 - 1996.65	0.92	1,163.28	487.84 - 1557.94	0.92	411.84	172.71 - 551.57	0.92	2,459.37	1031.38 - 3293.75	0.92
50	Bangladesh to LME#34. Bay of Bengal	11,107.20	4657.98 - 14875.5	0.92	21,167.69	8877.02 - 28349.19	0.92	7,494.15	3142.8 - 10036.67	0.92	44,752.00	18767.48 - 59934.86	0.92
50	Belgium to LME#23. North Sea	14,146.99	5932.77 - 18946.59	0.92	21,195.67	8888.75 - 28386.65	0.92	7,504.06	3146.95 - 10049.93	0.92	44,811.14	18792.28 - 60014.07	0.92
50	Bhutan to LME#34. Bay of Bengal	9,743.61	4086.14 - 13049.3	0.92	21,167.69	8877.02 - 28349.19	0.92	7,494.15	3142.8 - 10036.67	0.92	44,752.00	18767.48 - 59934.86	0.92
68	Bolivia to LME#13. Humboldt Current	214.72	90.05 - 287.57	0.92	422.52	177.19 - 565.86	0.92	149.59	62.73 - 200.34	0.92	893.27	374.61 - 1196.33	0.92
70	Bosnia and Herzegovina to LME#26. Mediterranean	6,433.01	2697.79 - 8615.52	0.92	11,128.87	4667.07 - 14904.53	0.92	3,940.04	1652.32 - 5276.76	0.92	23,528.27	9866.96 - 31510.63	0.92
70	Botswana to LME#30. Agulhas Current	4,689.03	1966.42 - 6279.86	0.92	7,858.44	3295.57 - 10524.25	0.92	2,782.18	1166.75 - 3726.08	0.92	16,614.04	6967.37 - 22563.63	0.92
76	Brazil to LME#15. South Brazil Shelf	280.94	117.82 - 376.25	0.92	2,112.79	927.97 - 2963.19	0.92	783.41	328.54 - 1049.21	0.92	4,676.20	1861.88 - 6265.33	0.92
76	Brazil to LME#16. East Brazil Shelf	122.26	51.17 - 163.74	0.92	962.97	403.84 - 1289.67	0.92	340.93	142.97 - 456.59	0.92	2,035.87	853.78 - 2726.58	0.92
76	Brazil to LME#17. North Brazil Shelf	571.46	239.65 - 765.33	0.92	4,500.99	1887.56 - 6028.02	0.92	1,593.52	668.27 - 2134.14	0.92	9,515.83	3990.62 - 12744.23	0.92
84	Belize to LME#12. Caribbean Sea	1,097.00	460.05 - 1469.18	0.92	1,163.28	487.84 - 1557.94	0.92	411.84	172.71 - 551.57	0.92	2,459.37	1031.38 - 3293.75	0.92
84	Virgin Islands (British) to LME#12. Caribbean Sea	1,692.38	709.73 - 2266.54	0.92	1,163.28	487.84 - 1557.94	0.92	411.84	172.71 - 551.57	0.92	2,459.37	1031.38 - 3293.75	0.92
100	Bulgaria to LME#26. Mediterranean	2,330.43	977.3 - 3121.07	0.92	11,128.87	4667.07 - 14904.53	0.92	3,940.04	1652.32 - 5276.76	0.92	23,528.27	9866.96 - 31510.63	0.92
100	Bulgaria to LME#62. Black Sea	8,710.90	3653.06 - 11666.21	0.92	41,598.53	17445.02 - 55711.53	0.92	14,727.43	6176.19 - 19723.96	0.92	87,946.16	36881.66 - 117783.35	0.92
104	Myanmar to LME#34. Bay of Bengal	12,033.02	5046.24 - 16115.42	0.92	21,167.69	8877.02 - 28349.19	0.92	7,494.15	3142.8 - 10036.67	0.92	44,752.00	18767.48 - 59934.86	0.92
112	Belarus to LME#23. North Sea	29,863.38	12523.69 - 39995.02	0.92	71,378.35	29933.68 - 95594.65	0.92	25,270.60	10597.64 - 33844.07	0.92	150,905.61	63284.73 - 202102.85	0.92
116	Cambodia to LME#3. California Current	1,187.57	498.03 - 1590.48	0.92	1,645.78	690.18 - 2204.13	0.92	582.67	244.35 - 780.35	0.92	3,479.44	1459.16 - 4659.9	0.92
120	Cameroon to LME#28. Guinea Current	10,509.35	4407.27 - 14074.82	0.92	20,790.05	8718.65 - 27843.42	0.92	7,360.45	3086.73 - 9857.61	0.92	43,953.59	18432.66 - 58865.58	0.92
124	Canada to LME#2. Gulf of Alaska	216.39	90.75 - 289.8	0.92	3,359.50	1408.86 - 4499.26	0.92	1,189.39	498.79 - 1592.91	0.92	7,102.53	2978.56 - 9512.18	0.92
124	Canada to LME#3. Hudson Bay	524.41	219.92 - 702.33	0.92	8,141.68	3414.34 - 10903.87	0.92	2,882.46	1208.81 - 3860.38	0.92	17,212.84	7218.49 - 23052.59	0.92
124	Canada to LME#9. Newfoundland-Labrador Shelf	157.96	66.24 - 211.55	0.92	2,452.32	1028.42 - 3284.31	0.92	868.21	364.1 - 1162.77	0.92	5,184.60	2174.25 - 6943.57	0.92
124	Canada to LME#9. Scotian Shelf	1,060.60	444.78 - 1420.42	0.92	16,466.06	6905.31 - 22052.45	0.92	5,829.60	2444.74 - 7807.39	0.92	34,811.98	14598.97 - 46622.52	0.92
124	Canada to LME#4. Arctic Ocean	15.12	6.34 - 20.25	0.92	234.71	98.43 - 314.33	0.92	83.09	34.85 - 111.29	0.92	496.21	208.09 - 664.55	0.92
144	Sri Lanka to LME#34. Bay of Bengal	25,932.46	10875.54 - 34730.48	0.92	21,167.69	8877.02 - 28349.19	0.92	7,494.15	3142.8 - 10036.67	0.92	44,752.00	18767.48 - 59934.86	0.92
144	Chile to LME#13. Humboldt Current	369.57	154.98 - 494.95	0.92	422.52	177.19 - 565.86	0.92	149.59	62.73 - 200.34	0.92	893.27	374.61 - 1196.33	0.92
156	China, People's Republic of to LME#36. South China Sea	1,810.54	759.28 - 2424.8	0.92	13,650.98	5728.95 - 18295.69	0.92	4,836.50	2028.26 - 6477.36	0.92	28,881.56	12111.95 - 36860.11	0.92
156	China, People's Republic of to LME#47. East China Sea	1,650.06	691.98 - 2209.87	0.92	12,450.11	5221.15 - 16674.01	0.92	4,407.80	1848.48 - 5903.22	0.92	26,321.58	11038.38 - 35251.61	0.92
156	China, People's Republic of to LME#48. Yellow Sea	4,477.33	1877.64 - 5996.34	0.92	33,821.51	14167.25 - 45243.79	0.92	11,960.27	5015.73 - 16017.99	0.92	71,421.80	29951.9 - 95652.84	0.92
170	Colombia to LME#11. Pacific Central-American	523.34	219.47 - 700.89	0.92	2,123.90	890.69 - 2844.46	0.92	751.94	315.34 - 1007.05	0.92	4,490.26	1883.07 - 6013.66	0.92
170	Colombia to LME#12. Caribbean Sea	286.64	120.21 - 383.88	0.92	1,163.28	487.84 - 1557.94	0.92	411.84	172.71 - 551.57	0.92	2,459.37	1031.38 - 3293.75	0.92
178	Congo to LME#28. Guinea Current	10,781.75	4521.5 - 14439.64	0.92	20,790.05	8718.65 - 27843.42	0.92	7,360.45	3086.73 - 9857.61	0.92	43,953.59	18432.66 - 58865.58	0.92
180	Democratic Republic of the Congo to LME#28. Guinea Current	8,817.57	3697.79 - 11809.08	0.92	20,790.05	8718.65 - 27843.42	0.92	7,360.45	3086.73 - 9857.61	0.92	43,953.59	18432.66 - 58865.58	0.92
188	Costa Rica to LME#11. Pacific Central-American	744.33	312.14 - 996.85	0.92	2,123.90	890.69 - 2844.46	0.92	751.94	315.34 - 1007.05	0.92	4,490.26	1883.07 - 6013.66	0.92
188	Costa Rica to LME#12. Caribbean Sea	407.68	170.97 - 545.99	0.92	1,163.28	487.84 - 1557.94	0.92	411.84	172.71 - 551.57	0.92	2,459.37	1031.38 - 3293.75	0.92
192	Croatia to LME#26. Mediterranean	6,318.80	2649.89 - 8462.56	0.92	11,128.87	4667.07 - 14904.53	0.92	3,940.04	1652.32 - 5276.76	0.92	23,528.27	9866.96 - 31510.63	0.92
192	Cuba to LME#12. Caribbean Sea	1,445.79	606.32 - 1996.3	0.92	1,163.28	487.84 - 1557.94	0.92	411.84	172.71 - 551.57	0.92	2,459.37	1031.38 - 3293.75	0.92
192	Cyprus to LME#26. Mediterranean	8,241.96	3708.02 - 11841.74	0.92	11,128.87	4667.07 - 14904.53	0.92	3,940.04	1652.32 - 5276.76	0.92	23,528.27	9866.96 - 31510.63	0.92
192	Czech Republic to LME#22. North Sea	10,857.65	4553.33 - 14541.28	0.92	21,195.67	8888.75 - 28386.65	0.92	7,504.06	3146.95 - 10049.93	0.92	44,811.14	18792.28 - 60014.07	0.92
200	Benin to LME#28. Guinea Current	13,077.95	5484.45 - 17514.86	0.92	20,790.05	8718.65 - 27843.42	0.92	7,360.45	3086.73 - 9857.61	0.92	43,953.59	18432.66 - 58865.58	0.92
200	Denmark to LME#22. North Sea	3,117.37	1307.32 - 4174.99	0.92	21,195.67	8888.75 - 28386.65	0.92	7,504.06	3146.95 - 10049.93	0.92	44,811.14	18792.28 - 60014.07	0.92
200	Denmark to LME#23. Baltic Sea	10,498.03	4402.52 - 14059.66	0.92	71,378.35	29933.68 - 95594.65	0.92	25,270.60	10597.64 - 33844.07	0.92	150,905.61	63284.73 - 202102.85	0.92
200	Denmark to LME#60. Faro Plateau	188.33	78.98 - 252.22	0.92	1,280.49	536.99 - 1714.92	0.92	453.34	190.12 - 607.14	0.92	2,707.16	1135.29 - 3625.61	0.92
214	Dominican Republic to LME#12. Caribbean Sea	1,545.87	648.28 - 2070.33	0.92	1,163.28	487.84 - 1557.94	0.92	411.84	172.71 - 551.57	0.92	2,459.37	1031.38 - 3293.75	

408	Democratic People's Republic of Korea to LME#47. East China Sea	1,949.18	817.42 - 2610.47	0.92	12,450.11	5221.15 - 16674.01	0.92	4,407.80	1848.48 - 5903.22	0.92	26,321.58	11038.38 - 35251.61	0.92
	Democratic People's Republic of Korea to LME#48. Yellow Sea	5,288.96	2218.01 - 7083.33	0.92	33,782.51	14167.25 - 45243.79	0.92	11,960.27	5015.73 - 16017.99	0.92	71,421.80	29951.19 - 95652.84	0.92
	Democratic People's Republic of Korea to LME#50. Sea of Japan/East Sea	3,101.98	1300.87 - 4154.38	0.92	19,813.46	8309.1 - 26535.5	0.92	7,014.70	2941.73 - 9394.56	0.92	41,888.91	17566.8 - 56100.43	0.92
410	Republic of Korea to LME#47. East China Sea	2,131.22	893.76 - 2854.27	0.92	12,450.11	5221.15 - 16674.01	0.92	4,407.80	1848.48 - 5903.22	0.92	26,321.58	11038.38 - 35251.61	0.92
	Republic of Korea to LME#48. Yellow Sea	5,782.93	2425.16 - 7748.88	0.92	33,782.51	14167.25 - 45243.79	0.92	11,960.27	5015.73 - 16017.99	0.92	71,421.80	29951.19 - 95652.84	0.92
	Republic of Korea to LME#50. Sea of Japan/East Sea	3,391.69	1422.36 - 4542.38	0.92	19,813.46	8309.1 - 26535.5	0.92	7,014.70	2941.73 - 9394.56	0.92	41,888.91	17566.8 - 56100.43	0.92
418	Lao People's Democratic Republic to LME#36. South China Sea	9,051.71	3795.98 - 12122.66	0.92	13,660.98	5728.95 - 18295.69	0.92	4,836.50	2028.26 - 6477.36	0.92	28,881.56	12111.95 - 38680.11	0.92
422	Lebanon to LME#26. Mediterranean	6,439.34	2700.44 - 8624.24	0.92	11,128.87	4667.07 - 14904.53	0.92	3,940.04	1652.32 - 5276.76	0.92	23,528.27	9866.96 - 31510.63	0.92
428	Latvia to LME#23. Baltic Sea	35,828.36	15025.21 - 47983.73	0.92	71,378.35	29933.68 - 95594.65	0.92	25,270.60	10597.64 - 33844.07	0.92	150,905.61	63284.73 - 202102.85	0.92
430	Liberia to LME#26. Mediterranean	18,505.35	7760.52 - 24783.59	0.92	20,790.05	8718.65 - 27843.42	0.92	7,360.45	3086.73 - 9857.61	0.92	43,953.59	18432.66 - 58865.58	0.92
434	Libyan Arab Jamahiriya to LME#26. Mediterranean	6,311.36	2646.77 - 8452.6	0.92	11,128.87	4667.07 - 14904.53	0.92	3,940.04	1652.32 - 5276.76	0.92	23,528.27	9866.96 - 31510.63	0.92
440	Lithuania to LME#23. Baltic Sea	33,510.99	14053.38 - 44880.15	0.92	71,378.35	29933.68 - 95594.65	0.92	25,270.60	10597.64 - 33844.07	0.92	150,905.61	63284.73 - 202102.85	0.92
442	Madagascar to LME#30. Agulhas Current	6,968.10	2922.19 - 9332.15	0.92	7,858.44	3295.57 - 10524.55	0.92	2,782.18	1166.75 - 3726.08	0.92	16,614.04	6967.37 - 22250.63	0.92
448	Malaysia to LME#34. Bay of Bengal	3,758.44	1576.16 - 5033.55	0.92	21,167.69	8877.02 - 28349.19	0.92	7,494.15	3142.8 - 10036.67	0.92	44,752.00	18767.48 - 59934.86	0.92
	Malaysia to LME#35. Gulf of Thailand	76.35	32.02 - 102.25	0.92	429.98	180.32 - 575.86	0.92	152.23	63.84 - 203.88	0.92	909.05	381.22 - 1217.46	0.92
	Malaysia to LME#36. South China Sea	2,425.58	1017.21 - 3248.5	0.92	13,660.98	5728.95 - 18295.69	0.92	4,836.50	2028.26 - 6477.36	0.92	28,881.56	12111.95 - 38680.11	0.92
466	Mali to LME#27. Canary Current	914.58	383.54 - 1224.86	0.92	3,826.67	1604.78 - 5124.93	0.92	1,354.78	568.15 - 1814.42	0.92	8,090.22	3392.76 - 10834.96	0.92
	Mali to LME#28. Guinea Current	4,968.83	2083.76 - 6654.59	0.92	20,790.05	8718.65 - 27843.42	0.92	7,360.45	3086.73 - 9857.61	0.92	43,953.59	18432.66 - 58865.58	0.92
478	Mauritania to LME#27. Canary Current	2,965.74	1243.73 - 3971.91	0.92	3,826.67	1604.78 - 5124.93	0.92	1,354.78	568.15 - 1814.42	0.92	8,090.22	3392.76 - 10834.96	0.92
484	Mexico to LME#3. California Current	247.74	103.89 - 331.79	0.92	1,645.78	690.18 - 2204.13	0.92	582.67	244.35 - 780.35	0.92	3,479.44	1459.16 - 4659.9	0.92
	Mexico to LME#4. Gulf of California	2,370.27	994.01 - 3174.43	0.92	15,746.08	6603.37 - 21088.19	0.92	5,574.70	2337.84 - 7466.01	0.92	33,289.80	13960.62 - 44583.92	0.92
	Mexico to LME#5. Gulf of Mexico	2,879.34	995.25 - 3188.99	0.92	15,792.03	6622.65 - 21149.74	0.92	5,590.97	2346.66 - 7487.8	0.92	33,386.96	14001.37 - 44714.05	0.92
490	Moldova to LME#62. Black Sea	19,732.66	8275.21 - 26427.3	0.92	41,598.53	17445.02 - 55711.53	0.92	14,727.43	6176.19 - 19723.96	0.92	87,946.16	36881.66 - 117783.35	0.92
498	Montenegro to LME#26. Mediterranean	6,004.91	2518.26 - 8042.18	0.92	11,128.87	4667.07 - 14904.53	0.92	3,940.04	1652.32 - 5276.76	0.92	23,528.27	9866.96 - 31510.63	0.92
504	Morocco to LME#26. Mediterranean	2,867.41	1202.5 - 3840.23	0.92	11,128.87	4667.07 - 14904.53	0.92	3,940.04	1652.32 - 5276.76	0.92	23,528.27	9866.96 - 31510.63	0.92
	Morocco to LME#27. Canary Current	985.96	413.48 - 1320.47	0.92	3,826.67	1604.78 - 5124.93	0.92	1,354.78	568.15 - 1814.42	0.92	8,090.22	3392.76 - 10834.96	0.92
	Mozambique to LME#30. Agulhas Current	5,012.94	2102.26 - 6713.67	0.92	7,858.44	3295.57 - 10524.55	0.92	2,782.18	1166.75 - 3726.08	0.92	16,614.04	6967.37 - 22250.63	0.92
518	Oman to LME#32. Arabian Sea	21,274.65	8921.87 - 28492.43	0.92	30,169.71	12652.16 - 40405.29	0.92	10,681.20	4479.34 - 14304.98	0.92	63,783.75	26748.76 - 85423.45	0.92
516	Namibia to LME#29. Benguela Current	3,124.29	1310.22 - 4184.25	0.92	4,613.74	1934.85 - 6179.03	0.92	1,633.44	685.01 - 2187.61	0.92	9,754.22	4090.59 - 13063.5	0.92
524	Nepal to LME#34. Bay of Bengal	9,178.18	3849.02 - 12292.03	0.92	21,167.69	8877.02 - 28349.19	0.92	7,494.15	3142.8 - 10036.67	0.92	44,752.00	18767.48 - 59934.86	0.92
528	Netherlands to LME#22. North Sea	14,615.34	6129.18 - 19573.83	0.92	21,195.67	8888.75 - 28386.65	0.92	7,504.06	3146.95 - 10049.93	0.92	44,811.14	18792.28 - 60014.07	0.92
540	New Caledonia to LME#40. Northeast Australia	1,692.66	709.85 - 2266.93	0.92	966.37	405.26 - 1294.23	0.92	342.13	143.48 - 458.21	0.92	2,043.07	856.8 - 2736.22	0.92
540	New Zealand to LME#46. New Zealand Shelf	2,518.46	1056.16 - 3372.89	0.92	1,476.56	784.87 - 2506.52	0.92	662.60	277.87 - 887.4	0.92	3,956.78	1659.34 - 5299.19	0.92
558	Nicaragua to LME#11. Pacific Central-American	691.81	290.12 - 926.52	0.92	2,123.90	890.69 - 2844.46	0.92	751.94	315.34 - 1007.05	0.92	4,490.26	1883.07 - 6013.66	0.92
	Nicaragua to LME#12. Caribbean Sea	3,789.1	1589.57 - 507.46	0.92	1,163.28	487.84 - 1557.94	0.92	411.84	172.71 - 551.57	0.92	2,459.37	1031.38 - 3293.75	0.92
562	Niger to LME#28. Guinea Current	10,873.93	4560.16 - 14663.09	0.92	20,790.05	8718.65 - 27843.42	0.92	7,360.45	3086.73 - 9857.61	0.92	43,953.59	18432.66 - 58865.58	0.92
562	Nigeria to LME#28. Guinea Current	11,375.19	4770.37 - 15234.42	0.92	20,790.05	8718.65 - 27843.42	0.92	7,360.45	3086.73 - 9857.61	0.92	43,953.59	18432.66 - 58865.58	0.92
562	Norway to LME#21. Norwegian Sea	1,528.58	641.04 - 2047.18	0.92	6,338.15	2658 - 8488.47	0.92	2,243.94	941.03 - 3005.23	0.92	13,399.88	5619.46 - 17946.02	0.92
562	Norway to LME#22. North Sea	5,111.80	2143.72 - 6846.06	0.92	21,195.67	8888.75 - 28386.65	0.92	7,504.06	3146.95 - 10049.93	0.92	44,811.14	18792.28 - 60014.07	0.92
562	Pakistan to LME#32. Arabian Sea	13,556.88	5685.3 - 18156.28	0.92	30,169.71	12652.16 - 40405.29	0.92	10,681.20	4479.34 - 14304.98	0.92	63,783.75	26748.76 - 85423.45	0.92
598	Panama to LME#11. Pacific Central-American	736.68	308.94 - 986.61	0.92	2,123.90	890.69 - 2844.46	0.92	751.94	315.34 - 1007.05	0.92	4,490.26	1883.07 - 6013.66	0.92
	Panama to LME#12. Caribbean Sea	403.49	169.21 - 540.38	0.92	1,163.28	487.84 - 1557.94	0.92	411.84	172.71 - 551.57	0.92	2,459.37	1031.38 - 3293.75	0.92
600	Paraguay to LME#14. Patagonian Shelf	3,331.12	1396.96 - 4461.26	0.92	5,793.14	2429.45 - 7758.56	0.92	2,050.99	860.12 - 2746.82	0.92	12,247.66	5136.26 - 16402.88	0.92
608	Peru to LME#13. Humboldt Current	301.05	126.25 - 403.18	0.92	422.52	177.19 - 565.86	0.92	149.59	62.73 - 200.36	0.92	893.27	374.61 - 1196.33	0.92
608	Philippines to LME#36. South China Sea	5,097.96	2137.91 - 6827.52	0.92	13,660.98	5728.95 - 18295.69	0.92	4,836.50	2028.26 - 6477.36	0.92	28,881.56	12111.95 - 38680.11	0.92
608	Philippines to LME#37. Sulu-Celebes Sea	6,425.88	2694.8 - 8605.96	0.92	17,219.40	7221.24 - 23061.37	0.92	6,096.31	2556.59 - 8164.58	0.92	36,404.65	15266.88 - 48755.54	0.92
616	Poland to LME#23. Baltic Sea	35,107.62	14722.95 - 47018.47	0.92	71,378.35	29933.68 - 95594.65	0.92	25,270.60	10597.64 - 33844.07	0.92	150,905.61	63284.73 - 202102.85	0.92
620	Portugal to LME#25. Iberian Coastal	2,497.74	1047.47 - 3345.14	0.92	2,682.17	1124.81 - 3592.14	0.92	949.59	398.23 - 1271.75	0.92	5,670.55	2378.04 - 7594.38	0.92
628	Guinea-Bissau to LME#28. Guinea Current	18,512.85	7763.67 - 24793.64	0.92	20,790.05	8718.65 - 27843.42	0.92	7,360.45	3086.73 - 9857.61	0.92	43,953.59	18432.66 - 58865.58	0.92
628	Timor-Leste to LME#38. Indonesian Sea	8,710.92	3653.07 - 11666.25	0.92	9,930.87	2487.21 - 7943.02	0.92	2,099.75	880.56 - 2812.12	0.92	12,538.84	5258.37 - 16792.85	0.92
630	Puerto Rico to LME#12. Caribbean Sea	1,612.49	676.22 - 2159.55	0.92	1,163.28	487.84 - 1557.94	0.92	411.84	172.71 - 551.57	0.92	2,459.37	1031.38 - 3293.75	0.92
640	Romania to LME#62. Black Sea	20,600.61	8640.04 - 27501.39	0.92	41,598.53	17445.02 - 55711.53	0.92	14,727.43	6176.19 - 19723.96	0.92	87,946.16	36881.66 - 117783.35	0.92
642	Russian Federation to LME#20. Barents Sea	128.55	53.91 - 172.16	0.92	4,956.21	2078.51 - 6637.82	0.92	1,754.72	735.87 - 2350.04	0.92	10,478.46	4394.31 - 14033.45	0.92
	Russian Federation to LME#54. Chukchi Sea	88.56	31.74 - 118.6	0.92	3,414.44	1431.9 - 4572.85	0.92	1,208.84	506.95 - 1618.98	0.92	7,218.69	3027.28 - 9667.75	0.92
	Russian Federation to LME#56. East Siberian Sea	46.31	19.42 - 62.02	0.92	1,785.58	784.81 - 2391.36	0.92	632.16	265.11 - 846.63	0.92	3,775.00	1583.11 - 5055.73	0.92
	Russian Federation to LME#57. Laptev Sea	175.99	73.8 - 235.7	0.92	6,785.50	2845.61 - 9087.59	0.92	2,402.32	1007.45 - 3217.35	0.92	14,345.67	6016.09 - 19212.67	0.92