



Intelligent Control of Home Appliances via Network

Rossello Busquet, Ana

Publication date:
2013

Document Version
Publisher's PDF, also known as Version of record

[Link back to DTU Orbit](#)

Citation (APA):
Rossello Busquet, A. (2013). *Intelligent Control of Home Appliances via Network*. Technical University of Denmark.

General rights

Copyright and moral rights for the publications made accessible in the public portal are retained by the authors and/or other copyright owners and it is a condition of accessing publications that users recognise and abide by the legal requirements associated with these rights.

- Users may download and print one copy of any publication from the public portal for the purpose of private study or research.
- You may not further distribute the material or use it for any profit-making activity or commercial gain
- You may freely distribute the URL identifying the publication in the public portal

If you believe that this document breaches copyright please contact us providing details, and we will remove access to the work immediately and investigate your claim.

Intelligent Control of Home Appliances via Network

Ana Rosselló-Busquet

May 2013



Networks Technology & Service Platforms
Department of Photonics Engineering
TECHNICAL UNIVERSITY of DENMARK
KGS. LYNGBY
DENMARK

*To my beloved father, who believed in me
and pushed me to always do better*

Preface

This thesis presents a selection of the research carried out during my Ph.D. studies in the Networks Technology and Service Platforms group, at Department of Photonics Engineering, Technical University of Denmark, from October 2009 to May 2013, under the supervision of Professor Lars Dittmann and José Soler.

This Ph.D. study focuses in two main hot topics: Home Energy Management and Information and Communication Technologies for the Smart Grid.

Abstract

This thesis addresses selected topics of energy management in home environments and ICT for the Smart Grid. However, those two topics are vast and only a few aspects of them have been discussed.

This thesis focuses on providing a home energy management solution based on a technology independent platform which guaranties interoperability, as well as scalability and flexibility. Therefore, a home gateway prototype has been developed in JAVA. This implementation offers the required capabilities for a Home Energy Management System, i.e. it enables the user to monitor and control the home devices, in addition to providing energy management strategies to reduce electricity consumption. Reducing energy consumption in home environments has become crucial to meet the "20-20-20" targets set by European Commission Climate Action.

However, reducing energy in home environments is not sufficient. The power grid has to be upgraded and improved into the Smart Grid. The Smart Grid will enable the power grid with new functionalities that will reduce power consumption, efficiently distribute energy and make a more robust and resilient power grid. Among the Smart Grid functionalities, there is Advanced Metering Infrastructure and Demand Response, which require a more active participation from customers. These two functionalities requirements regarding ICT are studied and a communication network for them is proposed. Power Line Communication has been considered the most suitable technology that fulfils all of the AMI and DR requirements. Specifically, G.hnem recommendation has been evaluated for the communication between customers and utilities.

Utilities will communicate with the customers via the so called smart meter found in users' premises. This smart meter will also be able to communicate with the home gateway of the Home Energy Management System. This exchange of information between the customers and the utilities is important as customers will have a more active role in the Smart Grid by

participating in Demand Response mechanisms. The presented Home Energy Management System in this thesis participates in reducing demand peaks by setting a maximum household consumption that cannot be exceeded during peak hours. There are two main motivations for reducing peak hours: (i) to avoid power shortages and blackouts, (ii) to reduce non-renewable energy consumption. During peak hours, utilities are forced to rapidly increase their electricity production in order to fulfil the demand. Usually non-renewable energies are used to reach the demand as, in general, renewable energies, such as solar and wind energies, cannot be controlled.

It is clear that AMI and DR will need to communicate with customers, who will become actively involved, in order to achieve the "20-20-20". In order to ensure, the customers' participation in Home Energy Management plays an important role, as most of this communication could be done automatically and without scarifying users' comfort. This will require the user's management of the Home Energy Management settings in order to fulfil his preferences.

The herein Home Energy Management System and AMI and DR proposed architecture have taken into consideration all the objectives and requirements to create a successful solution.

Resumé

Denne afhandling omhandler udvalgte emner af energistyring i det hjemligt miljø og IKT til Smart Grid. Til gengæld er disse to emner enormt men er der kun nogle aspekter af dem der er diskuteret.

Denne afhandling fokuserer på at levere et energiledelsessystem til det hjemligt miljø, der er baseret på en teknologi, uafhængig platform som garanterer interoperabilitet samt skalerbarhed og fleksibilitet. Af denne grund er et gateway prototype udviklet i JAVA. Denne implementering giver de fornødne muligheder for en Home Energy Management System, dvs det giver brugeren mulighed for at overvåge og kontrollere de hjem enheder ud over at give energistyrings strategier for at reducere elforbruget. Reducere energiforbruget i hjemmet miljøer er blevet afgørende for at opfylde EU's klima- og energipolitikker for "20-20-20" målene.

Men det er ikke tilstrækkeligt at reducere energiforbrug i det hjemligt miljø. Elnettet skal opgraderes og forbedres for at nå et "Smart Grid" som giver nye funktionaliteter, der vil reducere strømforbruget, effektivt distribuere energi og give et mere robust og modstandsdygtigt elnet. Blandt de Smart Grid funktionaliteter, er der Advanced Metering Infrastructure og fleksibelt elforbrug, hvilke kræver en mere aktiv kundersdeltagelse. De resulterende IT-krav af disse to funktionaliteter er undersøgt, og der gives et forslag om et kommunikationsnetværk for dem. Power Line kommunikation har været betragtet som den mest egnede teknologi, der opfylder alle AMI og DR-krav. Konkret har den G.hnem anbefaling blevet evalueret for kommunikationen mellem kunder og forsyningsselskaber.

Utilities vil kommunikere med kunderne via den såkaldte smart meter som findes i brugernes lokaler. Denne smart meter vil også være i stand til at kommunikere med husstandens gateway af husstandens energiledelsessystem. Denne udveksling af oplysninger mellem kunderne og de hjælpeprogrammer er vigtig, da kunderne vil have en mere aktiv rolle i Smart Grid ved at deltage i Demand reaktionsmekanismer. Den præsenterede Home En-

ergy Management System i denne afhandling deltager i reduktion af efterspørgslen topper ved at fastsætte en maksimal husholdningernes forbrug, som ikke kan overskrides i myldretiden. Der er to primære motivationer for at reducere myldretiden: (i) at undgå strøm mangel og strømafbrydelser, (ii) at reducere ikke-vedvarende energi. I myldretiden er værker tvunget til hurtigt at øge deres elproduktion for at opfylde efterspørgslen. Sendes ikke-vedvarende energi anvendes til at nå efterspørgsel for i almindelighed kan vedvarende energikilder, såsom sol og vind energi, ikke styres.

Det er klart, at AMI og DR bliver nødt til at kommunikere med kunder, der vil blive aktivt involveret, for at opnå den " 20-20-20 " mål. For at sikre at kundes deltagelse i Home Energy Management gives det højste prioritet, for de fleste af denne kommunikation kan ske automatisk og uden at gå ud over brugernes komfort. Dette vil kræve brugerens forvaltning af Home Energy Management-indstillinger for at opfylde sine præferencer.

Acknowledgements

I would like to thank my supervisors Professor Lars Dittmann and Dr. José Soler for their continued guidance and support.

It has been a pleasure working in the Network Technology and Service Platform group and I would like to thank all my colleagues for creating such an engaging working environment: Dr. Lars Staalhagen, Dr. Villy Bæk Iversen, Dr. Henrik Wessing, Dr. Sarah Ruepp, Dr. Anna Vaseliva Manolova, Dr. Yin Yang, Dr. Hao Yu, Dr. Rong Fu, Dr. Jiang Zhang, Dr. Georgios Kardaras, Dr. Lukasz Jerzy Brewka, Dr. Thang Tien Pham, Anders Rasmussen, Anna Zakrzewska, Jiayuan Wang and Brian Sørensen.

Ph.D. Publications

The following publications have been made throughout this Ph.D project.

1. Rossello Busquet, Ana; *G.hnem for AMI and DR*, part of: 2012 International Conference on Computing, Networking and Communications (ICNC) (ISBN: 978-1-4673-0008-7), 2012, IEEE, Type: Article in proceedings - Article in proceedings. Presented at: 2012 International Conference on Computing, Networking and Communications (ICNC), Maui, Hawaii.
2. Rossello Busquet, Ana; Kardaras, Georgios; Soler, José; Dittmann, Lars; *Towards Efficient Energy Management: Defining HEMS, AMI and Smart Grid Objectives* part of: Conference Proceedings of The Tenth International Conference on Networks, 2011, Type: Article in proceedings - Article in proceedings. Presented at: The Tenth International Conference on Networks, The Netherlands Antilles.
3. Soler, José; Rossello Busquet, Ana; Brewka, Lukasz Jerzy; Dittmann, Lars; Berger, Michael Stübert; *Networks and Services: A decade's perspective*, part of: Advances in Next Generation Services and Service Architectures, 2011, Type: Book chapter - Book chapter.
4. Rossello Busquet, Ana; Brewka, Lukasz Jerzy; Soler, José; Dittmann, Lars; *OWL Ontologies and SWRL Rules Applied to Energy Management*, part of: Proceedings 2011 UKSim 13th International Conference on Modelling and Simulation, 2011, Type: Article in proceedings - Article in proceedings. Presented at: 13th International Conference on Computer Modelling and Simulation, Cambridge.
5. Rossello Busquet, Ana; Soler, José; Dittmann, Lars; *A Novel Home Energy Management System Architecture*, part of: Proceedings 2011 UKSim 13th International Conference on Modelling and Simulation,

- 2011, Type: Article in proceedings - Article in proceedings. Presented at: 13th International Conference on Computer Modelling and Simulation, Cambridge.
6. Rossello Busquet, Ana; Kardaras, Georgios; Iversen, Villy Bæk; Soler, José; Dittmann, Lars; *Reducing Electricity Demand Peaks by Scheduling Home Appliances Usage*, part of: Energy Systems and Technologies for the Coming Century, 2011, Type: Article in proceedings - Article in proceedings. Presented at: Risø International Energy Conference : Energy Systems and Technologies for the coming Century, Roskilde, Denmark.
 7. Rossello Busquet, Ana; Soler, José; *A Novel Web Service Based Home Energy Management System*, part of: Proceedings of the Third International Conference on Advances in Future Internet AFIN, 2011, Type: Article in proceedings - Article in proceedings. Presented at: The International Conference on Advances in Future Internet, Nice/Saint Laurent du Var, France.
 8. Rossello Busquet, Ana; Soler, José; *Towards Efficient Energy Management: Defining HEMS and Smart Grid Objectives*, in journal: International Journal on Advances in Telecommunications, 2011. Type: Journal article - Journal article.
 9. Rossello Busquet, Ana; *Scheduling home-appliances to optimize energy consumption*, Type: Poster - Poster. Presented at: Grøn Dyst, Kgs. Lyngby, Denmark.
 10. Rossello Busquet, Ana; Kardaras, Georgios; Iversen, Villy Bæk; Soler, José; Dittmann, Lars; *Scheduling home appliances for energy efficient buildings*, part of: Proceedings FRUCT, 2010, Type: Article in proceedings - Article in proceedings. Presented at: 8th Conference of Finnish-Russian University Cooperation in Telecommunications, Lappeenranta.
 11. Kardaras, Georgios; Rossello Busquet, Ana; Iversen, Villy Bæk; Soler, José; *Regulating electricity demand peaks for home appliances using reversible fair scheduling*, part of: IEEE 4th International Conference on Internet Multimedia Services Architecture and Application(IMSAA), 2010, Type: Article in proceedings - Article in proceedings. Presented at: IEEE International Conference on Internet Multimedia Systems Architecture and Application, Bangalore, India.

12. Rossello Busquet, Ana; Soler, José; Dittmann, Lars; *Reduction of Electricity Consumption and Electricity Demand Peak in Home Environments*, part of: Proceedings of the Fifth International Conference on Advances in Future Internet AFIN, 2011, Type: Article in proceedings - Article in proceedings. Presented at: The International Conference on Advances in Future Internet, Barcelona, Spain.

Contents

Preface	i
Abstract	iii
Resumé	v
Acknowledgements	vii
Ph.D. Publications	ix
1 Introduction	1
2 Home Energy Management System	7
2.1 Introduction	7
2.1.1 Objectives	7
2.2 Home Energy Management System	9
2.2.1 HEMS components	9
2.2.2 HEMS Objectives and Requirements	11
2.2.3 Related Work	15
2.3 Home Energy Management System Developed	17
2.3.1 System Architecture	18
2.3.2 Development Tools	19
2.3.3 Implementation	21
2.4 Reduction of Power Consumption in Home Environments	39
2.4.1 Power Consumption Models	39
2.4.2 Simulation Parameters	40
2.4.3 Results and Discussion	41
2.5 Optimization of Power Consumption in Home Environments	43
2.5.1 Simulation Parameters	44
2.5.2 Preliminary Analysis	45

2.5.3	Simulation Parameters	48
2.5.4	Results and Discussion	49
2.6	Conclusion and Further Work	50
3	Smart Grid Communication	55
3.1	Introduction	55
3.1.1	Power Grid Architecture Overview	56
3.1.2	Objective	58
3.2	The Smart Grid	58
3.2.1	Smart Grid Objectives	62
3.2.2	Smart Grid Functional Areas	65
3.3	Smart Grid Communication	68
3.3.1	Communication Requirements	69
3.3.2	Communication Technologies	73
3.4	Proposed Architecture	79
3.4.1	Neighborhood Area Network	80
3.5	ITU-T G.hnem Recommendation	81
3.5.1	G.hnem Network Architecture	82
3.5.2	G.9956 Data Link Layer Specification	84
3.5.3	G.9955 Physical Layer Specification	89
3.6	MATLAB Models	98
3.6.1	PLC Noise by Katayama et al.	100
3.6.2	PLC Noise by Hooijen	101
3.6.3	Statistical Time-Varying, and Frequency Selective Channel Model	102
3.6.4	Multi-Path Propagation Channel Model	103
3.7	Comparison of G.hnem with G3-PLC and PRIME	103
3.7.1	G3-PLC and PRIME overview	103
3.7.2	Simulation Description	105
3.7.3	Results and Discussion	107
3.7.4	Conclusions and Further Work	110
3.8	Analysis of G.hnem on the Low-Voltage Mains for AMI and DR	111
3.8.1	Simulation Description	111
3.8.2	Results and Discussion	113
3.8.3	Conclusions and Further Work	115
3.9	Conclusions	115
4	Conclusions and Outlook	117

Bibliography	119
List of Acronyms	133

List of Figures

1.1	Example of Energy Label for a refrigerator [1]	2
1.2	Demand Response potential by class [2]	4
1.3	Demand Response potential by strategies [2]	5
2.1	Home Energy Management System Goals	11
2.2	Home Energy Management System Requirements	12
2.3	System Architecture	19
2.4	OSGi Framework	20
2.5	OSGi Implementation	22
2.6	Overview of HEMSOnt ontology classes	25
2.7	Overview of HEMSOnt ontology properties and attributes	29
2.8	Screenshot of the User GUI	32
2.9	Screenshot of the Device Emulator GUI	33
2.10	Event Driven Scheduling Algorithm	37
2.11	Creation of <i>Instant Consumption</i> and <i>Power Consumed</i> individuals	38
2.12	Spreading task completion over time	47
2.13	RFS Algorithm Schematic	47
2.14	Shared Resources Example Case 1	49
2.15	Shared Resources Example Case 2	49
3.1	Power Grid Architecture Overview	56
3.2	NIST Reference Model [3]	60
3.3	ETP's Smart Grid Vision [4]	62
3.4	Main High-Level Objectives	63
3.5	AMI and DR Communication Architecture Overview	81
3.6	G.hnem Generic Network Architecture	83
3.7	G.hnem Protocol Reference Model	85
3.8	G.hnem Protocol Reference Model	86

3.9	G.hnem Transmitter Functional Blocks	90
3.10	Fragmentation and Aggregation	92
3.11	OFDM Symbol	97
3.12	PLC Noise by Katayama et al.	101
3.13	Computer Generated Noise	101
3.14	Sample Channel Transfer Functions $H(f)$	102
3.15	Transmitter Functional Blocks	104
3.16	Simulation Scenarios	107
3.17	FER vs SNR for PRIME by Hoch in [6]	108
3.18	FER vs SNR for G3-PLC by Hoch in [6] compared to the thesis results	109
3.19	FER vs SNR for G.hnem	110
3.20	Simulation Scenarios for G.hnem	111
3.21	Transfer Function for LV mains by [7] [7]	112
3.22	Simulation Results for G.hnem	113
3.23	Power Spectrum Density of Power Line Noise	114

List of Tables

1.1	ICT for Energy Management	3
2.1	Energy groups	41
2.2	HEMS input parameters	41
2.3	Electricity Savings	42
2.4	Home Appliances Characteristics	45
2.5	Results RFS	48
2.6	Results Scheduling Algorithm	50
3.1	Smart Grid Objectives relation to Smart Grid Functional Areas	67
3.2	Communication Requirements for Smart Grid Functional Areas [8]	69
3.3	Valid values of payload FEC encoding parameters	91
3.4	G.hnem Physical Layer Specification	95
3.5	Valid Cyclic Prefix Values	97
3.6	Variance Parameters	100
3.7	Technology Comparison [9]	105
3.8	Overview of Simulation Parameters	106
3.9	Path Parameters	112
3.10	SNR obtained following EN 50065 [10]	114
3.11	G.hnem bit rate and FER for 133B payload [10]	115

Chapter 1

Introduction

One of the biggest challenges of the 21st Century is climate change and therefore energy efficiency has become one of the main research areas. There is the trend to make any device more energy efficient in order to reduce its CO_2 footprint. The EU provides incentives for the industry to develop and invest in energy efficient product design. Following Directive 2010/30/EU, household appliances are granted an energy label according to their energy efficiency, as shown in Figure 1.1. Despite the fact that home appliances have become more energy efficient, electricity consumption in households has increased 30% over the last 30 years [11]. This is due to the fact that the number of appliances that can be found in households is also increasing. According to the International Energy Agency (IEA), European electricity consumption is going to increase 1.4% per year up to 2030, unless counter-measures are taken [4].

Therefore, the European Commission Climate Action has set three energy targets to be met by 2020, known as the “20-20-20” targets. These are [12]:

- A reduction in EU greenhouse gas emissions of at least 20% below 1990 levels
- 20% of EU energy consumption to come from renewable resources
- A 20% reduction in primary energy use compared with projected levels, to be achieved by improving energy efficiency.

The power grid has not changed significantly during the last century [13]. Therefore, the power grid has to be upgraded to solve the imminent need to efficiently generate, transmit and distribute electricity by incorporating

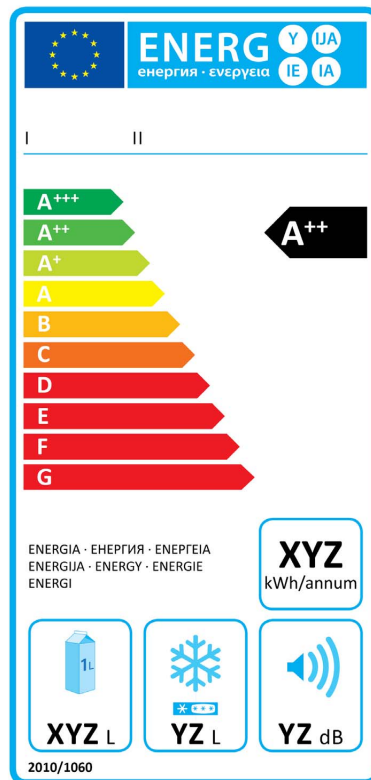

Figure 1.1: Example of Energy Label for a refrigerator [1]

Table 1.1: ICT for Energy Management

	ICT in Home Environments	ICT in the Power Grid	ICT linking the power grid and customers
Energy Goals	Reduce energy consumption Reduce demand peaks	Reduce losses and optimize energy distribution and production	Provide grids status information for efficient consumption and distribution
Who benefits?	Customers	Utilities ¹	Customers and utilities
How?	Home Energy Management System	Wide-Area Situational Awareness	Advanced Metering Infrastructure and Demand Response

renewable energies, reducing losses and avoiding blackouts. This upgrade in the power grid will lead to the so called Smart Grid. Smart Grids will incorporate Information and Communication Technologies (ICT) to provide bidirectional communication between the different actors involved, including customers. The power grid will undergo a significant improvement to provide actors with the capability to monitor and manage the power grid more efficiently and dynamically.

Information Communication Technology (ICT) will play an important role in achieving the “20-20-20” targets. The research domains of efficient energy management involving ICT can be divided into three more specific research areas: ICT in home environments, ICT in the power grid and ICT in linking the power grid and customers.

As shown in Table 1.1, energy consumption in home environments can be reduced by installing Home Energy Management System (HEMS) in users’ residences. An HEMS will provide users with the necessary tools to manage and reduce their consumption. In order to reduce losses and optimize energy distribution and production, the power grid elements need to be upgraded. Upgrading and introducing ICT in the power grid will lead to the so called Smart Grid. The Smart Grid will include new components and functionalities to efficiently manage the electricity distribution and production. Wide-Area Situational Awareness (WASA) will provide improved reliability and prevention of power supply disruption by monitoring the grid status. In addition, introducing ICT in the power grid will enable a two-way communication among the customers-location and utilities. ICT will benefit the users as it will enable the provision of real time rates and billing status. If users take into consideration the price of electricity while consuming and reduce their consumption when the price is high, consumption will be optimized as the utilities will be able to shift and shape demand. This can be achieved by using two of the new functionalities of the Smart Grid: Advanced Metering Infrastructure (AMI) and Demand response (DR). Providing this exchange of information is one of the first steps towards optimization of energy distribution and production as it will provide the utilities with statistical data that will help predict energy consumption.

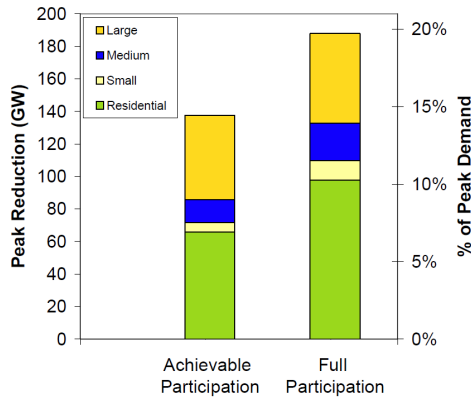

Figure 1.2: Demand Response potential by class [2]

AMI will provide the basis for energy-awareness. It is based on the new infrastructure of smart meters and devices that collect and process metering information. In order to successfully deploy AMI, the requirements from two different domains need to be understood: (i) the customer domain, which contains the home appliances and devices and should follow the customer needs and preferences, and (ii) the utility domain which is responsible for supplying electricity to the customer and defining differing tariff models used for DR. Nowadays, the majority of demand response comes from large commercial and industrial customers, where variable tariffs and demand bidding programs are used. However, it has been foreseen that the residential customers will represent most of the demand response by 2019 [2]. As shown in Figure 1.2, they may participate in the peak reduction as much as commercial customers.

Figure 1.3 depicts which demand response strategies are predicted to reduce the demand peak by 2019. Taking into consideration that pricing with technology is the strategy that will provide most peak reduction and that the class that will participate more in DR is residential users, HEMS becomes one of the key components on DR.

There are basically two types of communication infrastructure needed for the exchange of information of AMI and DR. The first communication network is found in the household, where information about the devices, consumption and user preferences is collected: Home Network Area (HAN). The other communication network need is between the customers and the utility data centers, which could be referred to as access network. In this scenario, the smart link acts as the linking node between them.

This thesis has been researching both domains and is focused on: Home

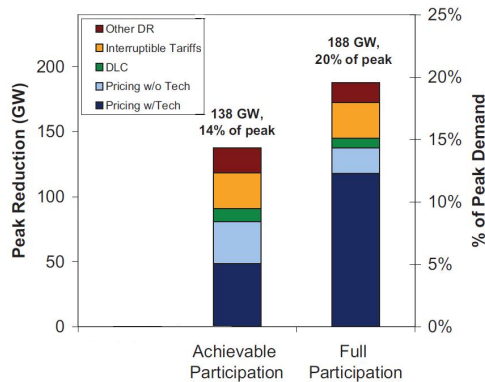

Figure 1.3: Demand Response potential by strategies [2]

Energy Management System and physical layer for Advanced Metering Infrastructure and Demand Response. The different goals that should be achieved in these areas in order to reduce energy consumption in home environment and make distribution and production of electricity more efficient are presented. When designing such systems, researchers usually focus on one of the existing goals. However, it is important that, when designing these systems, they are designed in the framework they are going to be deployed in and with all the goals they should achieve to maximize the benefits. In addition, this thesis provides an overview of G.hnem standard and discusses its advantages and disadvantages for its application for AMI and DR networks. Following this standard and the power grid topology a G.hnem network for AMI and DR is presented. This network provides a bidirectional communication among customers and utilities, which will allow the collection of consumption and generation information and the provision of real-time price information to customers.

Structure of the Thesis

This Ph.D. study resulted in peer-reviewed journal and conference contributions. The Ph.D. has centered in two related but distinguished domains: Home Energy Management System, where a HEMS is developed, and Smart Grid Communications, focused on the physical layer of the communication network among customers and utilities for AMI and DR.

Chapter 2 presents the research done on Home Energy Management System. Section 2.1 provides a brief introduction and the Ph.D. objectives for this first part. In the second section, the Home Energy Management

System developed during this Ph.D. is described. This section includes details on the implementation and the tools used for developing the system. Sections 2.4 and 2.5 analyze the performance of the implementation and present the results. The final section of this chapter provides the final conclusions and further work.

Chapter 3 presents the research done on Smart Grid Communication. The first section of this chapter provides an introduction to the present power grid, whereas the next section introduces the Smart Grid. Section 3.3 presents Information and Communication Technologies for Smart Grid. The proposed communication network for Advanced Metering Infrastructure and Demand Response are provided in Section 3.4. Section 3.5 gives an in-depth description of the ITU-T G.hnem recommendation. Section 3.6 describes the noise and channel models used to analyze the performance of G.hnem. Section 3.7 compares the performance of G.hnem with G3 PLC and PRIME. Further analysis of the performance of G.hnem is provided in Section 3.8. The conclusions and further work of this chapter are provided in the last section.

This thesis ends with Chapter 4, which provides the overall conclusions.

Chapter 2

Home Energy Management System

2.1 Introduction

Systems for home energy management may offer significant contribution to energy saving, the potential savings are estimated to 35% [14]. In addition, it could actively participate in Demand Response mechanisms, reduce electricity bills and Advanced Metering Infrastructure and obtain real-time billing status. However, this Energy monitoring and management of the elements in the home network should allow users to adjust their energy usage to their preferences, budget or specific situation. Furthermore, the information from this energy monitoring could be used, not only by the users, but also by the electricity providers and distributors. This information can be used to foresee the power consumption in an area and subsequently to reduce losses in the electricity production and distribution and avoid likely shortages. The electricity providers can modify the loads on the corresponding branches of their distribution network and build up statistical information allowing them to balance the loads in a proactive way. This can only be achieved if there is some communication between the users and the electricity provider/distributor. Energy management and monitoring will lead to beneficial outputs at different levels of granularity: for the users, for the communities, for the distributors.

2.1.1 Objectives

The objective defined at the beginning of this thesis was as follows:

“The aim of the thesis is to design energy management and monitoring mechanisms and an architecture for home-network environments with which users can control electricity usage in all the devices attached to the home network. As a proof of concept, a home gateway prototype with these energy monitoring and management capabilities has been developed. Furthermore, the mentioned prototype could also provide the electrical producers and distributors with the users’ information of power consumption and support remote access. Remote access could be used for different purposes, including enabling users to access their home network devices remotely (i.e. to turn them on or off) or as an external controller/manager to modify existing profiles or configuration issues. It is important to highlight that this solution should be based on a technology independent platform which guaranties interoperability as well as scalability and flexibility. In summary, the energy management and monitoring solution that is going to be studied could be based on an open platform and should include and allow:

- *Power consumption monitoring architecture/model: per device basis and overall consumption. It should:*
 - *Be technology independent.*
 - *Gather power consumption information.*
 - *Be scalable: provide different levels of granularity/information: home, building, suburb, city*
- *Enable users to manage power consumption of their devices in an automatic or manual way. Could be based on:*
 - *User energy profiles.*
 - *User energy rules.*
 - *Other.*
- *Enable communication with the electricity producer and distributor to offer all or some of the following services:*
 - *Advanced Metering Infrastructure.*
 - *Demand response.*
 - *Other.*
- *Additionally, provide remote control:*
 - *To monitor the house devices.*

- *To manage energy profiles and energy rules.*
- *To control the house devices [15].”*

2.2 Home Energy Management System

The Fraunhofer Society defines the Home Energy Management “as a device or system in the home used to: 1-Control an energy-consuming device, 2-Identify or diagnose energy saving opportunities, 3.Provide information to occupants to influence how they consume energy” [16]. The systems designed for home energy management could efficiently provide energy saving by using context-aware information, which can be achieved by using a suitable context model and a middleware level support [14]. The middleware shall offer interoperability among the home network devices even though home devices are usually manufactured by different producers and may use different communication technologies.

2.2.1 HEMS components

A Home Energy Management System (HEMS) usually consists of a Home Gateway or Residential Gateway, which acts as middleware, and the home network, which contains all the devices and home appliances. Furthermore, in the case herein presented, it has also been considered that the Smart Meter will participate in Demand Response and Advanced Metering Infrastructure and therefore should be included as part of the HEMS.

Home Network

The home network or Home Area Network (HAN) is a residential local communication network for devices found within the home. The home network might include a variety of technologies to enable the communication among all the home devices, such as ZigBee, Z-Wave, KNX, HomePlug and Wi-Fi among others. The devices found in the home network can vary from traditional home appliances, such as fridge or washing machine, to electric vehicles or renewable energy generators, in addition to being manufactured by different producers. In order to save energy in the home environment, the home users require to be able to monitor the power consumption of each device and manage these devices [17]. Therefore, the HEMS should be able to communicate, directly or by using a bridge, to all the devices in the home network. This can lead to interoperability issues between devices.

Therefore, the main challenge in home networks is the variety of technologies, providing different communication methods, as well as the diversity of producers, providing different types of devices and services.

Home Gateway

The Home Gateway is the main element of the HEMS and its functionalities may vary depending on the implementation. However, in order to be suitable for HEMS, it should provide at least: monitoring of power consumption, control of the home devices and energy management strategies. Most Home Gateways offer a graphical user interface from where the user can monitor and control the home devices and modify the settings of the energy management strategies. The energy management strategies should require the least human intervention as possible, while still offering the user some minimum setting options and maintain the optimum comfort level. The home gateway will probably be involved in Demand Response (DR) and AMI. The smart meter can communicate the real time price information to the home gateway which can display this information in a user graphical interface. Then, the HEMS, with this information and with some defined user preferences, or the user directly, can choose to reduce the energy consumption. Requests to reduce electricity consumption associated to DR mechanisms can also be forwarded from the smart meter to home gateway. The HEMS, can then, according to user preferences, accept or decline the requests from the utilities.

Smart Meter

The smart meter is found in consumers' premises and is used to measure electricity consumption. Smart meters are equipped with communication capabilities in order to transfer the measured information to the utilities. Therefore, the smart meter is one of the main elements of AMI and the information collected can be used for Wide-Area Situational Awareness (WASA) and DR. The smart meter is in charge of communicating this information to the utility, as this element should ensure the validity of the data collected. The smart meter may also be used to receive data from utilities, such as real time price or DR requests.

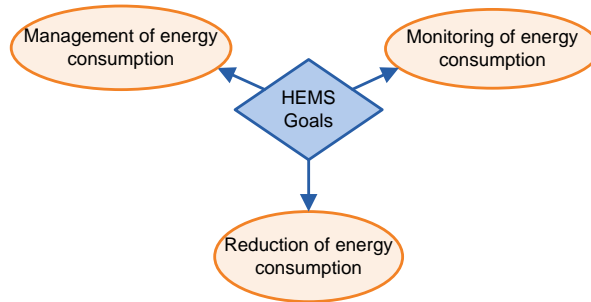

Figure 2.1: Home Energy Management System Goals

2.2.2 HEMS Objectives and Requirements

The main objectives of a HEMS are shown in Figure 2.1. HEMS main goal is to reduce the energy consumption. However, to achieve this, monitoring energy consumption and managing appliances are needed. In order to reduce energy consumption, it is first necessary to know how energy is consumed. Therefore, consumption monitoring is needed. Secondly, it is necessary to manage the appliances in order to apply energy reduction strategies. It has been considered that HEMS has to fulfil the requirements summarized in Figure 2.2 to achieve these goals satisfactorily:

- **Easy to deploy:** It has to be taken into consideration that HEMS should be easy to deploy into users' houses because deploying new cables or infrastructure is not the best solution. This requires using already installed communication systems, such as wireless communication or power line communication which will minimize the costs and gain users' acceptance.
- **Interoperability:** in order to monitor and manage users' appliances efficiently, a home network has to be introduced, where devices can exchange information and commands, without interoperability conflicts. The appliances found in users' premises are usually manufactured by different producers and may use different communication technologies which can lead to interoperability issues among devices.
- **Data security:** Security has to be incorporated into HEMS in terms of data encryption and authentication to protect the system against external threats. However, security issues will not be analyzed as they are out of the scope of this paper.

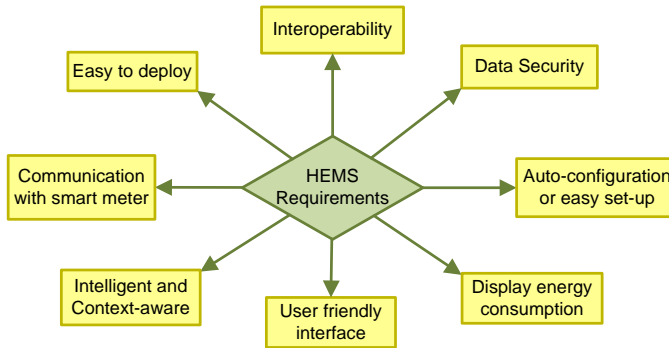

Figure 2.2: Home Energy Management System Requirements

- Auto-configuration or easy set-up: HEMS is going to be used by users without enough knowledge to perform network configuration tasks. Taking into consideration that users may add or change their home appliances, HEMS should provide easy to use configuration tools or in the best case the network should be auto-configurable.
- Display energy consumption: One of HEMS goals is to monitor energy consumption. This information should be available to users through the user interface. Furthermore, the displayed information could be shared with the utilities to create statistical data of energy usage in home environments, or with third parties. Current consumption and also previous consumptions, providing daily, monthly and even annual reports should be provided. Additionally, the possibility to compare the electricity consumption between months or even compare it to other sources, such as average neighborhood consumption or other users' consumption, is an interesting feature. This option could be a service provided by the Smart Grid through the smart meter.
- User friendly interface: The user interface should display information about the current consumption and also previous consumptions as stated above. Additionally, this interface should also provide management options, where the users can modify their preferences and control their appliances. User preferences are related to the strategy used to reduce users' energy consumption and can vary from system to system. It is also important to provide the possibility of controlling devices, as the system may apply undesired configurations and the user has to be able to correct them.
- Intelligent and context-aware: HEMS should have some intelligence

to facilitate efficient energy management. This can be achieved by creating a context-aware system. A context-aware system is capable of collecting information from the environment, or context, and of reacting accordingly. It is considered that a context-aware system can significantly improve the reduction of energy consumption. There are different ways in which context-aware systems can be implemented in HEMS: by defining energy policies or rules or by creating intelligent systems.

A HEMS that uses energy policies is a context-aware system which collects information from the environment and then uses this information together with the policies or rules to reduce energy consumption. This type of system is a static system and contains predefined policies or rules. However, these policies and rules may be modified at any time by the user by deleting, creating or modifying them. An intelligent HEMS requires a more complex system. An intelligent HEMS is defined as a system that reduces energy consumption by using context-aware information to predict users' behaviour and then applies the energy management strategy without compromising the users' comfort. Before being able to predict users' behaviour and apply the energy management strategy, there has to be a learning process. This learning process includes: (1) collecting context-aware information, which can include location-aware information, and (2) analyzing and processing this information to extract the users' routines and patterns. Once the learning process is completed, the system can extract the settings needed to reduce energy consumption. Unlike a rule based HEMS, this system is dynamic, adapts to the user and it is also self-evolving.

- **Communication with smart meter:** Enabling this communication will provide the user with real-time price and billing status, energy consumption information, as well as possible services that may arise. An example of a new service could be comparing the household energy consumption to other users' consumption. However, some of these new services could be offered through the Internet and not through the smart meter.

The main challenge in providing an efficient HEMS is interoperability. HEMS should provide seamless interaction between devices. However, there are a number of different home appliance manufacturers and communication technologies available for the user, which makes device interoperability

problematic. In addition, devices of the same type, such as washing machines, can have different functionalities depending on the model. Technical incompatibility has limited market possibilities. Users are looking for a ‘one size fits all’ solution without having to worry about compatibility requirements. Therefore, one of the main challenges in HEMS is the variety of technologies, providing different communication methods, as well as the diversity of producers, providing different types of devices and services.

Additionally, other challenging expectations from users have to be fulfilled, related to the following requirements: auto-configuration or easy set-up, user friendly interface and easy deployment:

- Easy to use and control: there is diversity in users’ preferences and expectations when interacting with HEMS. Some users would like an interface that will give them advanced options, while others would just like a simple system but without losing control of their devices [18]. Furthermore, users have different user interface preferences. Some users would like to use their mobile phone or PDA, while others would rather use their computer or a controller. An example of how to deal with this can be found in [19].
- Easy to configure: complex configuration or professional help to configure the network is a drawback. HEMS should be easy to configure or even be auto-configurable. However, this can be a challenge due to the heterogeneity of home appliances and home technologies. Strategies and mechanisms for software configuration and updates for devices installed in home environments can be found in [20,21].
- Easy software upgrade: home appliances can have software installed, which in some occasions has to be updated. Software update should be easy for users to perform. The authors in [20,21] present how to deal with software upgrades in home devices.

Moreover, designing HEMS as an intelligent and context-aware system is not an easy task and presents these following challenges:

- Design of context-aware systems, data collection and interpretation: HEMS may use sensors to collect information about the users’ behaviour. The system may have to work with different types of sensors and from different brands. This will force the system to be designed to deal with different sensor details, which sets a barrier to interoperability. [22] proposes an infrastructure to support software design and execution of context-aware applications using sensors to collect data.

Another issue is coping with the amount of data transmitted from home appliances and likely sensors. An example of how to deal with this can be found in [23].

- Policies and rules: There are two main challenges when using policies to implement energy management: coordination and contradiction. As the number of appliances in the house increases, so does the number of policies, which can lead to coordination problems and contradictory rules. Tools to identify interactions and detect conflict resolution between policies should be incorporated into HEMS to manage rules and policies more efficiently. An example of this can be found in [24,25].
- Intelligent HEMS: This type of HEMS should include an algorithm which will be able to learn and predict the users' behaviour after processing the collected data. Examples of such algorithms can be found in [26,27].
- Multiple-inhabitants: Prediction of users' behaviour when there is more than one user in the home environment adds complexity to the predicting algorithm as each user has his/her own routines, practices and policies/rules, which may be different for each user.
- Not compromising users' comfort: HEMS should not have undesirable outcomes, it should be an intelligent system that can adapt to different situations and user behaviour.

2.2.3 Related Work

In the past years, research has centred in developing home gateways for home automation and home energy management. The Home Gateway developed in this thesis is based on Open Service Gateway Initiative (OSGi) [28]. To create the knowledge base data repository for the home gateway implemented, OWL ontology [29] is used. Both these technologies have already been used to implement home gateways.

An example of a home gateway using OSGi and ontologies is Domotic OSGi Gateway (DOG) [30] by Politecnico di Torino. DogOnt [31] ontology is used in the home gateway developed in [30] and is re-used as well in the implementation herein described. This ontology provides a good classification of the devices that can be found in a home environment. However, this article will not describe this ontology, as an extensive description can

be found in [31]. The main difference between DOG and the home gateway herein presented is the fact that DOG is focused on domotics, while the home gateway herein is mainly concerned with energy management. The user can use it to define their own energy management system by creating, modifying and deleting rules, which may reduce the total electricity consumption.

In [32], another example of a home gateway developed using OSGi can be found. As with DOG, no energy management strategies are applied, since the necessary tools, for example a rule engine, are not provided.

Furthermore, the authors in [33] describe the IntelliDomof's learning model which is an ontology-based system, able to control a home automation system and to learn users' periodic patterns, when using home appliances.

In [34], a HEMS has been implemented to reduce stand-by consumption by setting a power line network. Similarly, in [35], a HEMS implementation using ZigBee and infrared communication to reduce stand-by consumption of power outlets and lights is presented. THE Hems proposed in this paper has two main advantages over [34] and [35]: 1-the energy management strategy can help reduce the consumption of all users' appliances and not only stand-by consumption; 2-the HEMS may communicate using different technologies and not only power line communication or ZigBee.

A HEMS is implemented in [36] to monitor the consumption of appliances. The implemented system does not offer any tools to apply energy management strategies unlike the HEMS presented in this paper.

SESAME-S project [37] has developed a Home Gateway very similar to the one presented here. They have also used OSGi and have developed their own ontology for energy management. However, in the implementation herein presented home gateway SQWRL and SWRL are used for queries and the rule-based energy management system, whereas in SESAME-S implementation they have used SPARQL Protocol and RDF Query Language (SPARQL) and PIE format for their queries and rules. This has some drawbacks as PIE format does not support mathematical operators and SPARQL has to be used as a work around. In addition, SESAME-S [38] does not produce any results on the home gateway related to energy management. Their focus is in the user's acceptance of their system. It is also worth mentioning that the home gateway developed by SESAME and the work herein presented were done in parallel.

2.3 Home Energy Management System Developed

The Home Energy Management System herein developed manages the home appliances to fulfil the reduction of overall consumption and reduction of peak demands. The main component of the HEMS is the Home Gateway, which can be seen as the system core. Web services are incorporated into the Home Gateway to offer modularity as some of the HEMS functionalities are external to the Home Gateway, such as Smart Meter or Energy Rules Server.

The HEMS developed offers the user a variety of basic functionalities in addition to more advanced and energy related functionalities, which are:

- **Monitor:** The user can obtain the current status of any device connected to the home network through the user interface, remote or not.
- **Control:** The user can send basic commands, such as On/Off and parametric commands, such as *Start Program 3* to any home appliance.
- **Data Validation:** The systems check that the commands to be sent to a device are actually valid for that device. For instance, if *Start Program 3* is sent to a lamp, the Home Gateway will detect the error and notify the user.
- **Power Consumption History:** In order to reduce electricity consumption, it is important to know how much electricity each appliance consumes.
- **Energy Management System:** The developed Home Gateway uses energy rules to help reduce the electricity consumption. The rules can be edited, deleted or created at any time and will be effective immediately without having to restart the system. The rules can be introduced into the system by the user. However, this requires that the user has advanced knowledge about the system, which is, in many cases, unrealistic. Therefore, the Home Gateway communicates with an Energy Rules Server. The user can connect to this server to browse all the rules and obtain a brief description of each rule so the most suitable rules, according to user's preferences, can be downloaded.

- **Scheduling Algorithm:** The scheduling algorithm will distribute the electricity consumption over time. Different appliances are scheduled to consume based on their priority type, which can be changed by using the remote access. The overall goal of this method is to guarantee that a defined electricity consumption limit, provided by the utility and approved by the user, will not be exceeded. This technique could result in a more distributed consumption and lower demand peaks, which can lead to a reduction of greenhouse gasses. Additionally, the system presented can also ease the task of forecasting consumption, as the customers will guarantee that they will not consume more than a pre-determined amount of power.

The following subsections provide more details about the above functionalities and an overview of the system's architecture and its implementation.

2.3.1 System Architecture

The Home Energy Management System herein designed and its components are depicted in Figure 2.3. The central element is the Home Gateway which can directly communicate with all the home appliances and sensors or can use a bridge to interconnect with them. The bridge in the herein HEMS is considered to be a forwarding component used to interface with devices that use a communication technology not available in the Home Gateway. This element has been included as the scenario where the home gateway is not able to communicate with some of the home network devices. Besides being able to communicate with the home devices, the Home Gateway can also communicate with the Smart Meter to exchange messages with the power utility, and enable remote access through the internet. The last element found in the herein design is the Energy Rules Server. The user can connect to this element through web services to enhance or modify their energy management strategies.

All the components of the HEMS are described in more detail in the following sections. However, an overview of the tools used to implement this system is provided first.

OSGi [28] is a well-known middleware platform in the smart home research and it is used to implement the Home Gateway. In order to include context-aware information in smart home applications, ontology-based modeling, as a central concept of the Semantic Web, has been established as a technology of choice. Ontologies, such as Ontology Web Language (OWL) have been chosen due its expressiveness, its capability to support semantic interoperability and its automated reasoning (using rule engines).

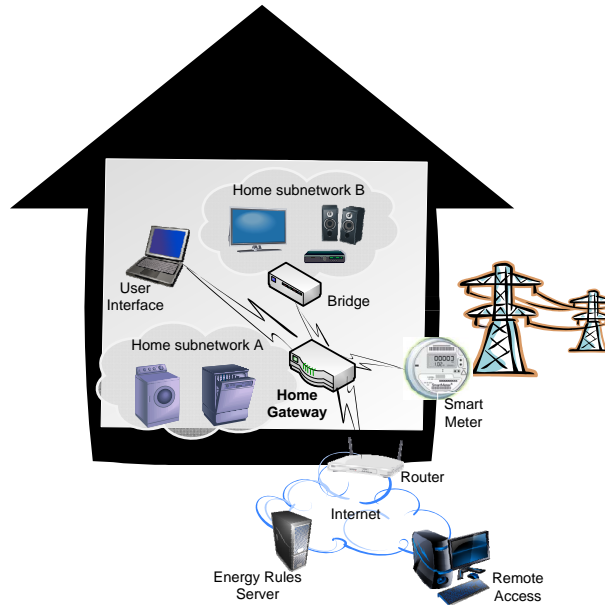

Figure 2.3: System Architecture

2.3.2 Development Tools

OSGi

The OSGi Service Platform Core Specification [28] defines a component and service model for JAVA referred to as OSGi Framework. The OSGi Framework [28] is an open service platform for the delivery and control of different JAVA-based applications, called bundles. Bundles are Java ARchive (JAR) files containing a group of JAVA classes and additional metadata, making them fully self-describing, which are able to export and/or import services from other bundles. In OSGi Framework, bundles and services can be installed/exported, uninstalled/imported and refreshed in a dynamic way, i.e. without the need of re-setting the framework, and services. Equinox OSGi [39] is an open source implementation of OSGi Framework. This OSGi container provides a Service Registry depicted in Figure 2.4. The OSGi Framework allows bundles to publish/add a service into the Service Registry where other bundles can subscribe to them. The services follow the client-server paradigm, where a bundle publishes or exports a service to other bundles that can subscribe or import.

The HEMS developed in this thesis has been implemented using Equinox OSGi Framework with Eclipse Software Development Kit (SDK) Version: 3.5.2 [40].

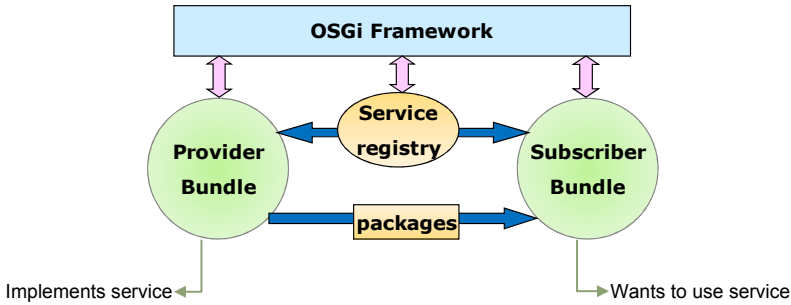

Figure 2.4: OSGi Framework

Protégé-OWL API 3.4.4

According to the entry in the Encyclopedia of Database Systems and in the context of database systems, “ontology can be viewed as a level of abstraction of data models, analogous to hierarchical and relational models, but intended for modeling knowledge about individuals, their attributes, and their relationships to other individuals” [41]. In the context of this thesis, the ontology describes the home environment, i.e. the home appliances and home devices, their properties and their relationship to each other. To represent this knowledge, Web Ontology Language 2 [29] is used. This standard language allows abstraction away from data structures and implementation strategies providing interoperability at the service level. They differ from database schemas as those are models of data at theological or physical level [41]. Ontologies are independent from lower level data models and the implementation they are used in. Therefore, to create the knowledge base data repository for the HEMS developed, an ontology written in OWL 2 is used. OWL 2 is endorsed by the World Wide Web Consortium (W3C) [42] and allows to write ontology concepts in a standard conceptual vocabulary using Resource Description Framework (RDF)/Extensible Markup Language (XML) [43]. In order to create and modify OWL ontologies, Protégé v3.4.4 [44] editor has been used. To access the OWL from the JAVA implementation Protégé-OWL Application Programming Interface (API) 3.4.4 [45] has been used. Protégé-OWL API 3.4.4 [45] is a JAVA API that provides the necessary mechanisms to manipulated ontologies from a JAVA application. In addition, it also enables the use of Semantic Query-Enhanced Web Rule Language (SQWRL) [46] and Semantic Web Rule Language (SWRL) [47]. Information on the knowledge base data repository is accessed by using SQWRL, which is used to create queries. SQWRL is based on SWRL and provides SQL-like operations to retrieve knowledge from them. SWRL is based on a combination of the OWL-DL

and OWL-Lite, which are sublanguages of the OWL. Rules are written in SWRL, which are used to reason about objects using the ontology hierarchy and attributes. Jess Rule Engine [48] is used to run the rules and queries.

Apache CXF Distributed OSGi

The W3C defines a web service as "a method of communication between two electronic devices over a network. A web service is a software system designed to support interoperable machine-to-machine interactions over a network. It has an interface described in a machine-process-able format (specifically WSDL)." [49]

Web services are incorporated into the home gateway developed to offer modularity. The first implementation of the home gateway considered did not include web services and, therefore, considered that all the functionalities herein explained were contained in the same device, namely the home gateway. However, the most probable scenario is that the HEMS system has different logical components deployed in separated devices.

To incorporate web services into the home gateway developed, Apache CXF Distributed OSGi [50] is used. The Apache CXF Distributed OSGi implements the Distribution Provider component of the OSGi Remote Services Specification, enabling easy integration of web services into OSGi platform with SOAP over HTTP. Furthermore, CXF-DOSGi will auto-generate the Web Services Description Language (WSDL) from the java interface at the time of deployment. This distribution enables an easy integration of web services into OSGi platform.

2.3.3 Implementation

The HEMS has been implemented using Equinox OSGi. The components of the HEMS consist of one or more bundles. Each bundle has a specific functionality and can interact with other bundles in the same component or with other bundles in another component through web services. The components, its bundles and their interaction are depicted in Figure 2.5. In order to test the Home Gateway functionalities, some of the components, such as the Smart Meter, Energy Rules Server, bridges and home appliances have been emulated.

In the following subsections, some details on the bundles of each component and their functionality are provided. However, two more extended documents have been created: User Guide [51], which includes instructions

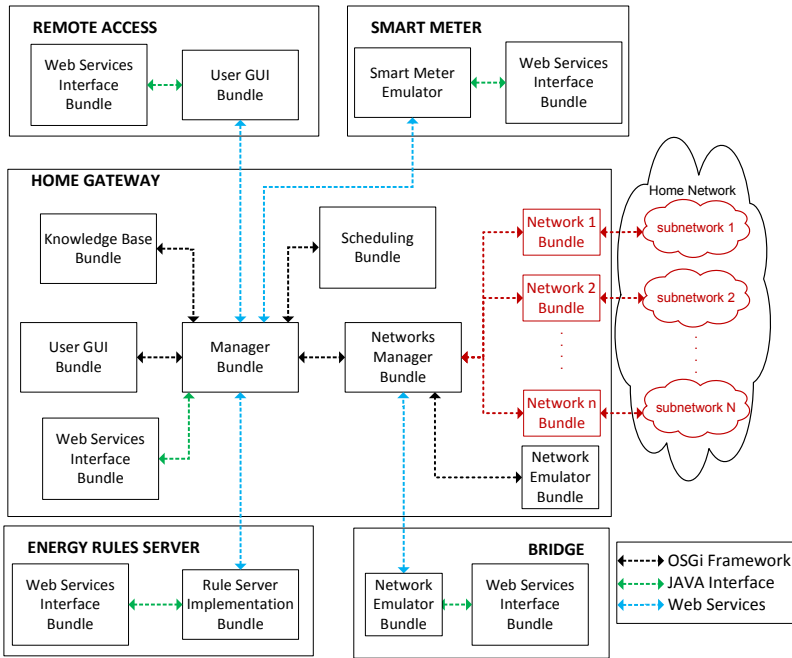

Figure 2.5: OSGi Implementation

on how the home gateway user interface works, and Developers Manual [52], in which details on the implementation for further research are provided.

Home Gateway

The Home Gateway is the core of the HEMS and holds most of its functionalities. However, as it has been developed using OSGi, the bundle implementing a specific functionality can be easily uninstalled and deployed in another external device. The home gateway designed is aimed for a HEMS. It offers interoperability at the service level between its components, which interact through web services. It provides a knowledge base data repository, where information about the devices is stored, and also a rule engine. This knowledge base data repository is implemented by an ontology, where the home devices are classified according to their functionalities and capabilities. Moreover, the ontology contains a classification of the different commands and states a home device can support. Using this knowledge base data repository, energy management strategies can be performed by applying a set of rules, which are based on the energy consumption of the home devices, information from the electrical grid and users' preferences.

The rule engine is used to run the rules that will help the user reduce the energy consumption at home. Furthermore, the home gateway provides a user interface from where the devices and rules can be managed.

The first implementation of the home gateway developed did not contain web services or the scheduling system. However, in the final version, web services were introduced to offer scalability to the system and the scheduling system was introduced to help reduce demand peaks.

Knowledge Base Bundle

The functionality of the Knowledge Base Bundle is to handle the interaction between the knowledge base data repository, implemented on OWL, with the rest of the architecture. Information about the devices, such as their capabilities, status and network parameters among others can be obtained from the knowledge base data repository by using queries. In addition, this bundle contains the means to apply energy management strategies by using rules. Jess Rule Engine [48] is used for running the rules and queries. Protégé-OWL API 3.4.4 [45] is used for manipulating the ontology. This API also provides methods to run SQRL queries and create, modify and delete SWRL rules.

This bundle offers a service to access to the knowledge base data repository, allowing the subscribed bundles to obtain information about the devices and energy management rules. This service is only used by the Manager bundle as a mid-step to query the knowledge base data repository. The Manager bundle will offer the functions provided by this service to the rest of the bundles. In this way, there is a separation between the knowledge data base repository, which directly accesses and queries the knowledge base data repository, and the Manager bundle used by bundles that need to obtain information about devices or rules. This is done to facilitate the modularity of the system.

Implementing the knowledge base data repository with ontology differs from conventional databases, as the unique identifier of an object is denoted inside a domain and allows logical formalisms. This allows the creation of a knowledge base without forcing a particular encoding strategy. An OWL ontology consists of OWLClasses, OWLIndividuals and OWLProperties.

DogOnt ontology v1.0.4 [53] is used to create the initial knowledge base data repository of the home gateway. In DogOnt, OWLClasses are used to represent the necessary basic concepts for the home environments, such as type of home devices, for example television or washing machine; structural, for example the different rooms in the household, among others. OWLIndi-

viduals are instances of those classes and represent the actual home object and not the concept, for example *Television_Livingroom* or *MyLivingroom*. Properties are used for linking the individuals in the ontology and creating relationships. For instance, the individual *Television_Livingroom* can be linked to the individual *MyLivingroom* with the property *isIn*.

DogOnt has been extended to include energy management concepts, for example appliances consumption and kWh price. This enhanced ontology has been called HEMSOnt. An overview of the OWLClasses of the HEMSOnt is depicted in Figure 2.6 and Figure 2.7 depicts the attributes and relationships, i.e. OWLProperty. The highlighted classes in those diagrams are the new classes implemented to extend DogOnt.

The main classes of the DogOnt are briefly described below. For further details on this ontology refer to [31]:

- **Building environment**: encompasses the locations that can be found in the house, for example bedrooms, garage or even garden.
- **Building thing**: models the objects in the house and is further divided into **Controllable**, which refers to the home devices and **Uncontrollable**, which refers to the physical components of the house. **Controllable** class has more subclasses which are used to classify the home devices according to their type. An individual of the class **Controllable** is linked to one or more individuals of the **Functionality** class, depending on the device and its capabilities.
- **Functionality**: is used to characterise the functionalities of the **Building Thing**. This class is further divided into three subclasses:
 - **Control Functionality**: models the ability of devices to be controlled, for example, open/close functionality of a window or set temperature of a thermostat. The individuals of this class are linked to their corresponding *command individual* by hasCommand.
 - **Notify Functionality**: it is used to model the functionality of devices that send status updates, such as sensors. The individuals of this class are linked to their corresponding *notification individual* by hasNotification.
 - **Query Functionality**: models the ability of a device to be queried or polled about its condition or status.

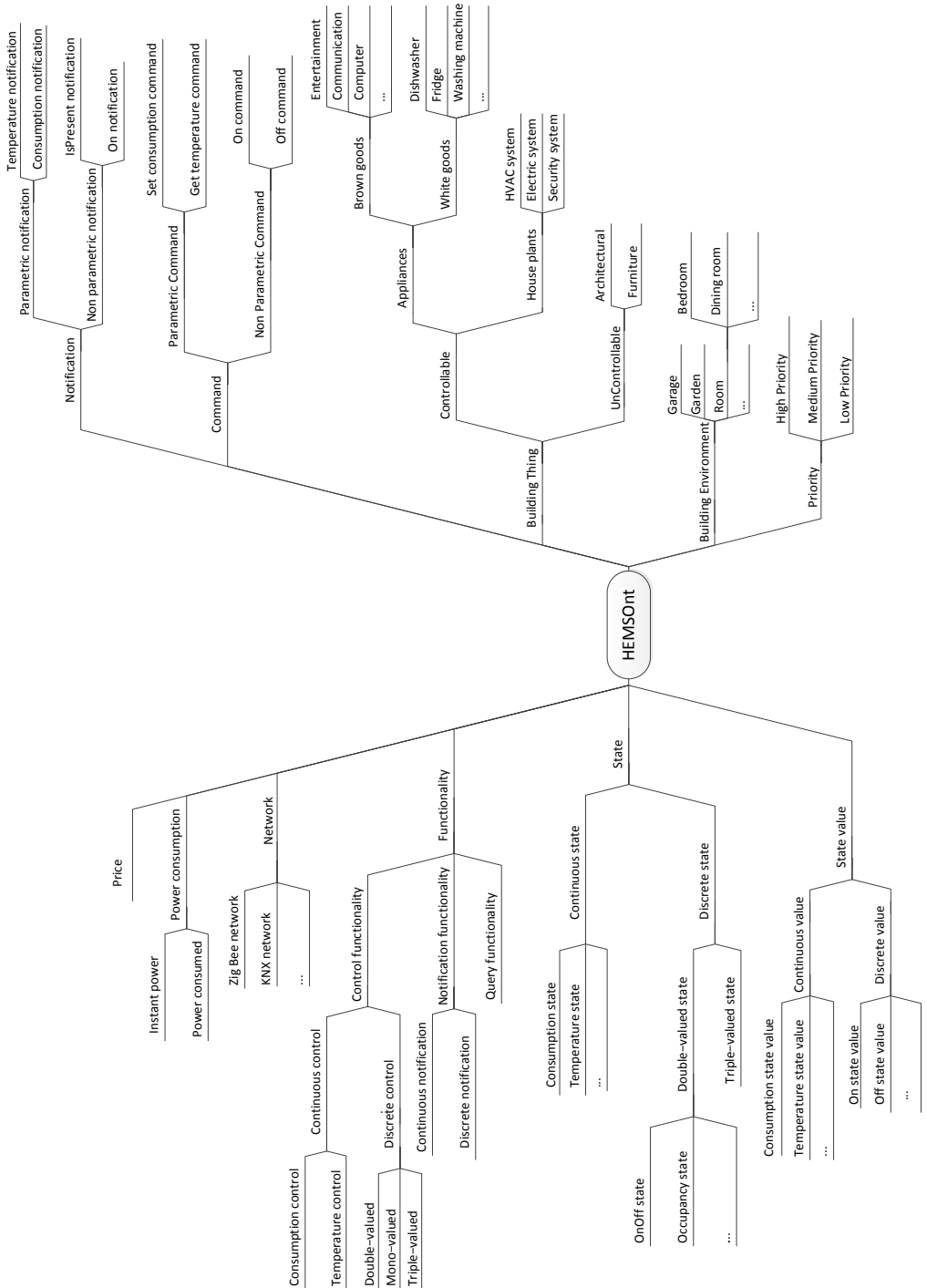

Figure 2.6: Overview of HEMSOnt ontology classes

- **Command:** models the commands of the home devices. This class is further divided depending on whether the command has parameters, such as set temperature, or has no parameters, such as turn on. A *command individual* is linked to an individual of the class **State Value** by causeStateValue.
- **Notification:** models the possible notifications of the home devices. This class is further divided depending on whether the command has parameters, such as temperature measurement, or has no parameters, such as presence (notification received when the sensor detects there is someone). A *notification individual* is linked to an individual of the class **State Value** by causeStateValue.
- **State Value:** models the possible states a device can be in. For instance, a device can be on or off, this will be represented with two different *discrete state value individuals*, whereas temperature will be represented by a *continuous state value individual*, which will also contain the valid range for temperature.
- **State:** models the actual state a home device is in, i.e. if a device is on or off at a certain moment.
- **Network:** models the sub-networks in the home environment. *Controllable individuals* are linked to the corresponding *network individual* by the property hasGateway.

Three main classes and subclasses have been implemented and included to the DogOnt using Protégé Editor [44]. Additionally, to adapt the DogOnt to the HEMS herein developed, some subclasses have been added into the already existing OWLClasses to deal with the energy management concepts. These new OWLClasses are explained below:

- **Power Consumption:** This class is used to model the power consumed by the home appliances. It is further divided into:
 - **Power Consumed:** used to model the total consumption (kWh) of a device for a certain amount of period of time. An individual of this class must have three attributes: “DateStart”, “DateEnd” and “TotalConsumption”.
 - **Instant Power:** used to model the instant consumption (Watts) of a device for a certain period of time. An individual of this class must have three attributes: “TimeStart”, “TimeEnd” and “InstantConsumption”.

This class is used to store the consumption of the home devices and create the historical consumption data, which is further explained in 2.3.3.

- **Priority:** This class has been created to implement the scheduling algorithm, which is explained in detail in 2.3.3. It has three subclasses, which refer to the priority of an appliance: **High Priority**, **Medium Priority** and **Low Priority**. In order to implement the scheduling algorithm, the general state of the appliance is needed, i.e. the scheduling algorithm needs to know if the device is active, inactive or in reduced mode; but does not need to know the actual status, i.e. what program the washing machine is running on. This is modelled with the attribute “stateEnergy”.
- **Consumption Control Functionality**, subclass of Continuous Control Functionality: This class is also related to the scheduling algorithm. It is used by home appliances that have the capability of reducing their consumption. For example, the washing machine or the dishwasher could be able to heat up the water using less power, which would make them take a longer period of time to do it. As the other Continuous Control Functionality, this OWLClass has the attributes “maxValue” and “minValue”, which would correspond to the maximum power and minimum value the appliance can consume to do its task.
- **Price:** This class models the actual price of electricity. This information is provided and updated by the utilities. As the type of information provided by the utilities is still unclear, a general class has been created with the following attributes: “price” (euros/kWh), “maxConsumption” and “minConsumption”. An individual of this class will contain the information of the price for a certain consumption range.
- Consumption related classes: to implement the HEMS, some additional classes to the already existing classes have been created:
 - **Query Consumption:** is a subclass of **Query Functionality** and models the ability of a device to be queried about its present power consumption.
 - **Consumption Functionality:** used to model the capability that a device can reduce its power consumption and still do its

- task, i.e. a device that heats water is able to reach the desired water temperature with less power but in a longer period of time.
- **Set Consumption Command**: is a subclass of Parametric Command and is related to the **Consumption Control Functionality** by the property hasCommand. It models the command that can be sent to the appliance in order to reduce its consumption to a certain level.
 - **Notification Consumption Command**: is a subclass of Parametric Notification and is related to the **Consumption NotificationFunctionality** by the property hasNotification. It models the ability of the device to send updates about its power consumption.
 - **Consumption State Value**: is a subclass of Continuous State Value and can be related to the **Consumption Command** or **ConsumptionNotification** by the property causeStateValue. An individual of this class will provide the range of valid power consumption for a certain appliance.
 - **Consumption State**: an individual is used to represent the actual power consumption of a certain device.

Some of the main properties and attributes of the HEMSOnt are depicted in Figure 2.7.

The implemented HEMS is based on rules. These rules are developed to reduce the power consumption in home environments trying not to affect users' comfort. Existing rules can be modified or deleted and more rules can be added to the knowledge base data repository to adapt to the users' preferences. The system herein presented offers the possibility to change the rules at any time through the user interface provided by the home gateway and also remotely.

The rules in this system have been written in SWRL which can be used to reason about OWLIndividuals by using OWLClasses and properties terms. In order to run these rules from the JAVA platform Protégé-OWL API 3.4.4 and Jess Rule Engine are used. However, SWRL rules have a drawback for this implementation. The state of the devices, which is saved in the knowledge base data repository, cannot be changed by using SWRL, as stated in [54]: "SWRL rules cannot be used to modify existing information in an ontology" Instead an SWRL can add new information or values into the knowledge base data repository. In other words, if a rule is fired where the state value wants to be changed, this will result in the

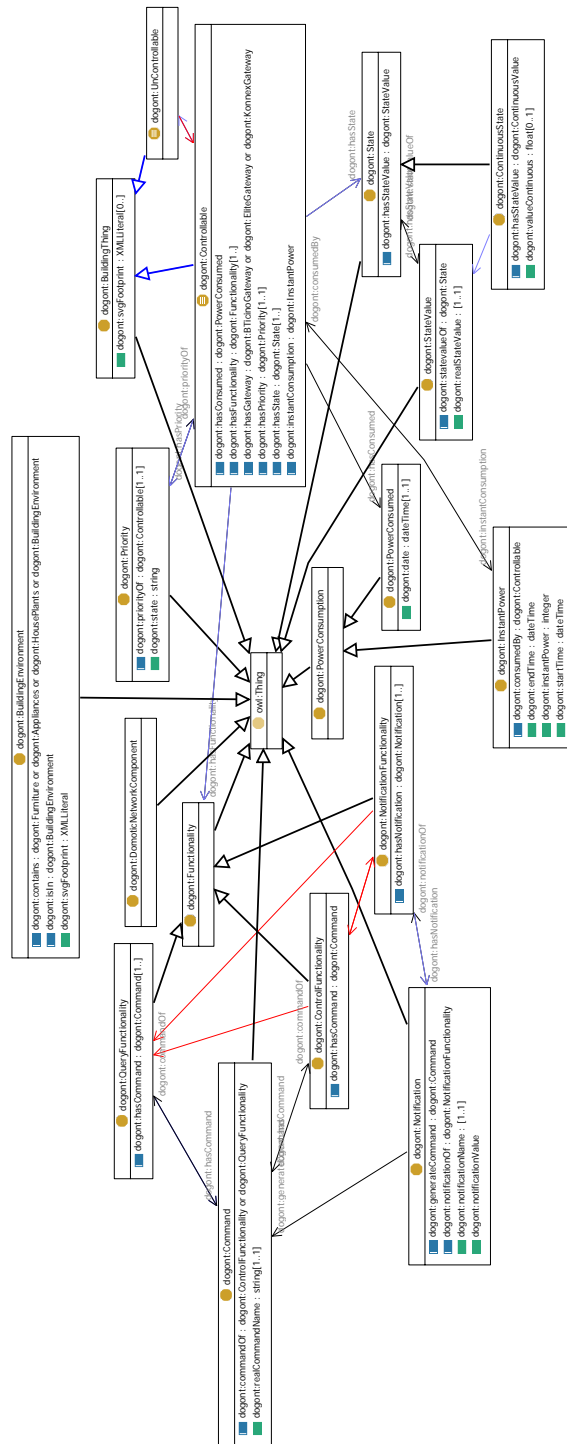

Figure 2.7: Overview of HEMSOnt ontology properties and attributes

property value having two values. In order to solve this problem SWRL-BuiltInBridge [55], contained in Protégé-OWL API , is used. SWRLBuiltInBridge provides a mechanism that allows the use of user-defined methods in rules. These methods are called built-ins and can be seen as functions of the rule system. These user-built-ins are implemented in a java class and dynamically loaded into the rule engine, which can then invoke them when necessary.

In order to create user defined built-ins, first an ontology containing the definition of these user-built-ins must be created and imported into the java implementation. The package name should end with the name of the ontology defining the built-ins. Additionally, the SWRLBuiltInLibraryImpl class must extend the abstract base class AbstractSWRLBuiltInLibrary. The user-built-ins' definition for our implementation are contained in HEMSOnt and implemented in the java SWRLBuiltInLibraryImpl class contained in edu.stanford.smi.protegex.owl.swrl.bridge.-builtins. HEMSOnt must be included in the Protégé-OWL API. These user-built-ins can be used in SWRL rules by calling them using *owlmod:* prefix and then the name of the method found in the java class. This class will also import the knowledge base data repository in order to be able to change the information about the devices. In order for the above rule to work, `dogont:value(?Lstate, "Off")` is replaced by `owlmod:change-state(?Lstate, "Off")`

All rules will be evaluated every time the knowledge base data repository is changed. For instance, if the home gateway receives a status update the status of the devices will be changed in the knowledge base data repository, and then the Jess rule engine will evaluate and trigger the necessary rules. When a rule is triggered and a device in a home network has to change status, a message is sent to the target device by using the Manager bundle service and the corresponding Network bundle.

Scheduling Bundle

This bundle implements the scheduling algorithm and ensures that the maximum consumption is not past a certain limit set by the user. The main concept behind this approach is the aggregation of home appliances into priority classes and the definition of a maximum power consumption limit, which is not allowed to be exceeded. If the user sets a maximum consumption, every time an appliance is turned on, a request to consume is sent to this bundle. This bundle will reply accepting or declining the request. This bundle is also capable of sending *pause* and *resume* commands to the household appliances. The *pause* command is used to force the

appliance to go into stand-by mode. The *resume* command is used to switch the appliance from stand-by mode to on, where the appliance will then continue its task. The Scheduling Bundle will decide which appliances can be paused and when they should continue their task by following the event driven scheduling algorithm provided in 2.3.3.

This bundle uses SQWRL queries to obtain information from the HEM-SONt, such as “which are the low priority class appliances that are active”. This scheduling algorithm can be activated/de-activated by the user at any-time. In addition, the maximum consumption that cannot be exceeded can also be set by the user. In this implementation, the priorities of the appliances cannot be changed through the graphical interface.

User GUI Bundle

The home gateway developed provides a Graphical User Interface (GUI) which is contained in this bundle. This interface enables the user to send commands and queries to the devices, obtain information about them (like their status or valid commands) and manage the energy management rules. The user can also use this interface to incorporate a new device to the knowledge base data repository and create, modify, delete and download rules to apply energy savings. In addition, the user gets notifications of status updates and requests to reduce consumption. The user can activate the scheduling algorithm and set the maximum consumption from this interface. Figure 2.8

In order to offer all this functionalities through the user interface, this bundle subscribes to the service offered by the Manager bundle using OSGi Service Registry. This user interface maybe contained within a separate device from home gateway, for example the users’ computer. In this situation, the computer connects to the Manager bundle service through web services.

Network n Bundle

The home network found in the users’ premises can contain devices using different communication technology, for example power line or wireless. Each of the Network n bundle installed in the Home Gateway will handle the communication with the devices in the sub-network n. These bundles will send messages to the devices and forward notification messages from the devices (i.e. notification of change of status), behaving as technology bridges.

Each Network n bundles offers its own service that enables other bundles to send messages to the devices in the sub-network. In case the Network bundle is in the Home Gateway, OSGi Service Registry is used to publish/-

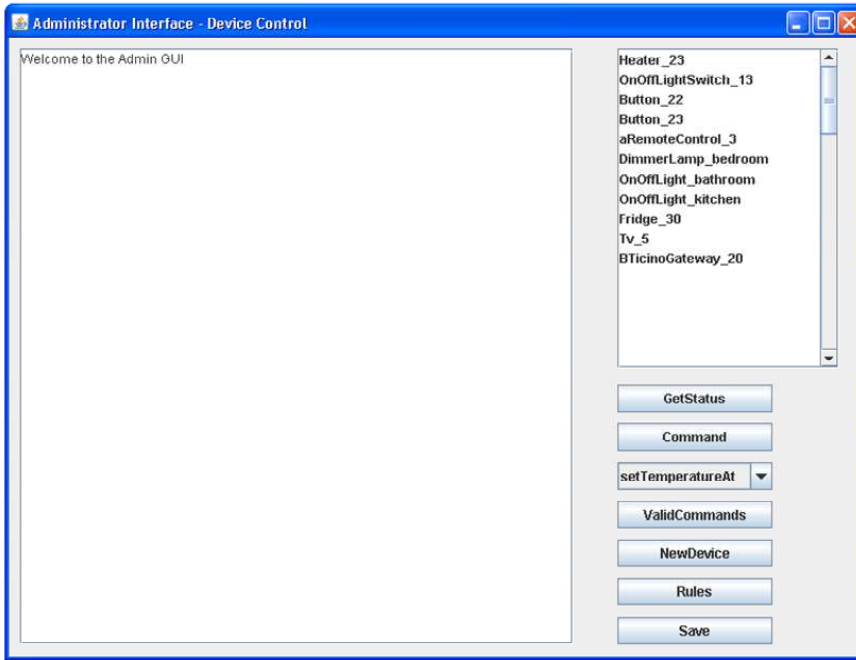

Figure 2.8: Screenshot of the User GUI

subscribe to the service. On the other hand, if the Network bundle is found on a bridge, then the service is exported as a web service, where the bridge will be acting as a server.

The focus of this paper is not on enabling technologies in the physical layer and their interoperation, but on the software mechanisms that allow use of the different elements, regardless of the connectivity mechanisms towards the home gateway. The home network is therefore emulated and an GUI is provided to emulate changes in the devices' status, which is shown in Figure 2.9. This bundle functionalities and interaction with the rest of the architecture are equivalent to Network n bundle. Two Network Emulator bundles are used, one contained in the home gateway and another contained in a bridge separated from the home gateway device. The Network Emulator bundle contained in the bridge interacts with the Manager bundle by using web services. On the other hand, the Network Emulator bundle, contained within the home gateway, uses the OSGi Service Registry. Both of these Network Emulators provide a user interface from where the devices' status can be changed; for instance, the status of a switch or sensor.

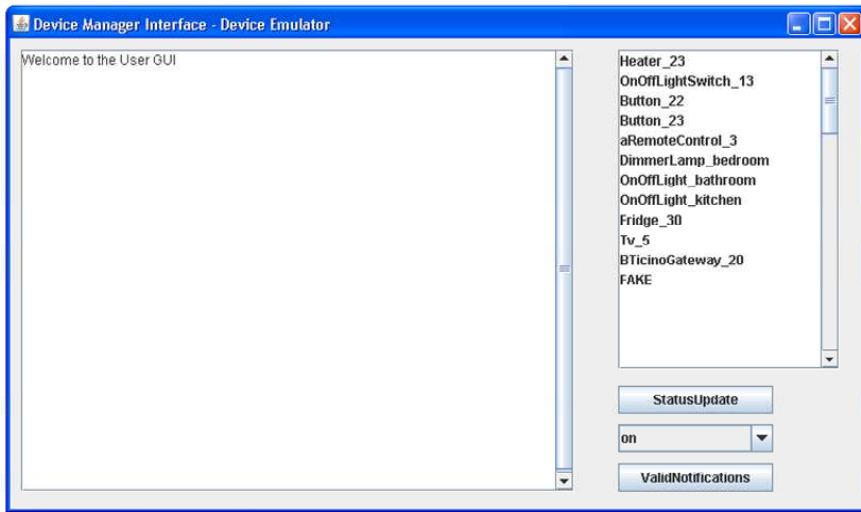

Figure 2.9: Screenshot of the Device Emulator GUI

Networks Manager Bundle

Due to the fact that various Network n Bundles may exist, inside the Home Gateway and also in bridges, this bundle is created to handle the communication with these Network n bundles. This bundle will receive all the messages that have to be sent to the home network devices and forward it to the corresponding Network n bundle of the sub-network hosting the target.

Manager Bundle

This is the central bundle which handles the interaction between the different bundles and contains the web services implementation and therefore acts as the server. It uses web services to communicate with bundles found outside the Home Gateway, such as the Smart Meter or the Energy Rules Server and OSGi Service Registry to communicate within the Home Gateway.

This bundle offers different functionalities. Firstly, this bundle can be seen as a mid-step to query the knowledge base data repository. This is done to facilitate the modularity of the system. The Knowledge Base Operator service is used to directly access and query the knowledge base data repository. The Manager Functions service is used by bundles that need to obtain information contained in the knowledge base data repository. The bundles inside and outside the home gateway used this service to obtain information about the home network and its devices. For example, the GUIs

bundles use this service to obtain the list of the home network devices and commands for those devices. The Network Manager bundle uses this service network information of the devices; for instance, the sub-network hosting the device.

Another functionality of this service is to provide access to the rules servers by using a Rules Provider service. A Manager service includes the necessary methods to bridge the GUI to the Energy Rules Server.

Web Services Interface Bundle

In order to implement the web services for the home gateway, this bundle is required. It provides the JAVA interfaces needed by the client and the server of the web service to make the exchange of information possible. This bundle is used to define the methods that can be used through the provided web services. This bundle must be included in both components, namely the client and the server, as the interfaces are in need of both sides to successfully implement the web services.

Bridge

The home gateway could provide some of the communication technologies found in the home network. However, as new technologies appear, some extra Network bundles may be needed and the possibility of using bridges external to the home gateway to communicate with some of the home devices is a probable scenario. For this reason, these bundles could be found in the home gateway or in a different device, such as a bridge, as shown in Figure 2.5.

Remote Access

In order to emulate the remote access a User Interface has been deployed in another computer, which communicates with the Home Gateway using web services. The only difference between the User Interface Bundle contained here and the one inside the Home Gateway is the way they interact with the Manager bundle. In the case of the remote interface, web services are used.

Smart Meter

A Smart Meter has been implemented to emulate the possible communication with the Home Gateway. In this implementation, the Smart Meter sends two types of messages to the Home Gateway: (i) actual kWh price, and

(ii) request to reduce consumption. When a request to reduce consumption is made, the Home Gateway will reply with an acceptance/rejection message depending on whether the user has activated the scheduling algorithm or not.

Energy Rules Server

The users may want to update the energy management strategies of the HEMS by including more rules. This bundle provides a service that enables rules stored in this bundle to be downloaded and saved into the knowledge base data repository. The users are able to connect to this rules server using the GUI and to download the rules they select. This service is implemented as a webservice, where the Rules Server bundle is the server of the web service and the Manager bundle is the client. This service will provide methods to view the available rules, its names and a brief description, and also to download any SWRL rule to be deployed in the HEMS.

Similar to the Home Gateway Web Services Interface Bundle, the Energy Rules server needs a bundle to provide the JAVA interfaces needed by the client and the server of the web service to make the exchange of information possible.

Using rules servers and web services, the user is not forced to write his/her own rules. (S)he can obtain them from a rule server or, expanding the concept presented here, the rules can even be downloaded from other users.

Energy Management Strategies

The Home Gateway developed offers different functionalities related to energy management. Firstly, by using rule-based policies, it identifies energy saving opportunities and reacts consequently. The rules can be modified to adapt to the preferences of the user and aim to maintain the optimum comfort level. Secondly, the Home Gateway provides a scheduling algorithm to limit the consumption. This will enable consumers to actively participate in Demand Response without or with minimal human intervention. Finally, the Home Gateway monitors and collects consumption information to create the historical data.

Rule-Based Energy Management

The rules developed for the HEMS are based on the “if-then” paradigm, i.e. if a certain situation occurs, where energy can be saved, an action to

reduce the consumption will take place. The main aim of the rules that have been implemented is to test the HEMS performance. They can be seen as the first step towards energy savings, as they are general and could be suitable for most home environments and user preferences.

The HEMS developed is not limited to the rules presented in 2.4.2. More rules can be added to the HEMS, for instance rules regarding heating, ventilation, and air conditioning (HVAC) systems. However, in order to implement these rules and emulate their consumption, detailed information about the HVAC systems, home architecture and home isolation is necessary. As this information is specific for each home environment and depends on a few factors, it has not been included in the simulations presented in the next section.

Rules related to kWh price could easily be added to this system. However, due to the fact that these rules basically depend on users' preferences and do not reduce power consumption, they have been omitted in this implementation. An example of a possible rule related with the electricity price would be: "if the kWh price is higher than *amount*, then turn off *low priority appliances*".

Scheduling Algorithm

The aim of the implemented scheduling algorithm is to spread the electricity consumption to reduced or even avoid electricity demand peaks. The event driven scheduling algorithm showed in Figure 2.10 is used to keep the total consumption of the household under the determined limit. The algorithm is triggered by two events: request to consume and end of consumption.

The Manager bundle sends a request to consume to the Scheduling bundle when the users switch the appliance on. The Scheduling Bundle then calculates if there is enough power to switch on that appliance without exceeding the maximum consumption. If the consumption of the appliances is already switched on, plus the consumption of the new appliance does not exceed the maximum consumption, then the appliance requesting to consume electricity is switched on. On the other hand, if switching on the new appliance would exceed the maximum consumption, the algorithm proceeds to examine the priorities of the appliances already switched on. The bundle tries to find a subset of the appliance(s) switched on, which have lower priority than the appliance requesting to consume. This subset of appliances should free enough electricity consumption so the new appliance can be switched on without exceeding the limit. If a subset fulfilling this

condition is found, the appliances in the subset is paused and added to the paused appliances list. The bundle grants access to the new appliance without exceeding the maximum power consumption. In case a subset of appliances could not be found, the new appliance is added to the paused appliances list.

When an appliance is switched off, an end of consumption event is sent to this bundle. The bundle then checks the paused appliances by querying the HEMSOnt. If there are paused appliances, the bundle checks if there is enough power to switch the first paused appliance on. If the paused appliance can be switched on without exceeding the maximum power consumption, a *resume* command is sent to the paused appliance and HEMSOnt is updated. Furthermore, if another paused appliance can be switched on without exceeding the maximum consumption, a *resume* command is also sent to this appliance and it is removed from the paused appliances list. The bundle evaluates whether each paused appliance can be switched on or not.

In order to get users to accept that the users' low priority appliances will be paused and therefore take longer for them to finish their task, utilities could offer them a reduction in the electricity bill. This can be used as a commercial strategy by utilities to face a more homogeneous consumption by using attractive pricing schemes. It has to be taken into consideration that electricity bills are increasing along with the number of electrical appliances and users are interested in reducing their electricity bill. In particular, during the winter of 2007/08, 20% of Americans could not pay on time their electricity bill and 8.7 million American consumers were disconnected from their electricity utility services [56].

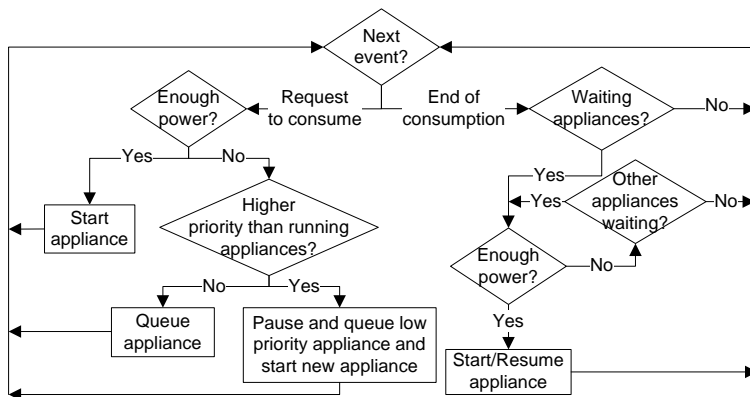

Figure 2.10: Event Driven Scheduling Algorithm

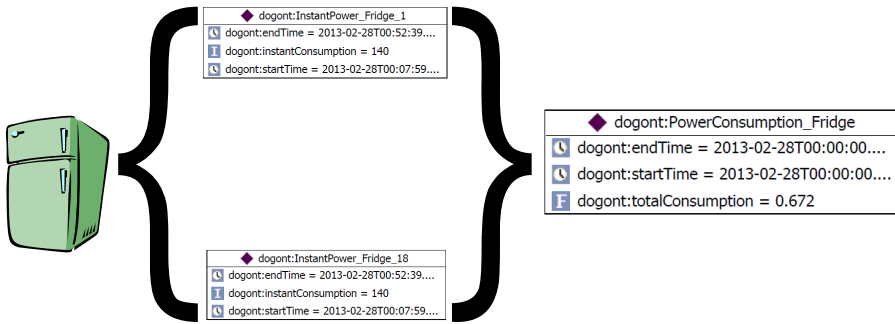

Figure 2.11: Creation of *Instant Consumption* and *Power Consumed* individuals

Monitoring

The HEMSOnt has been extended to include historical data of the electricity consumption of the home devices. This is done by including the new class **Power Consumption**. The historical data provided by this HEMS has two levels of granularity: (i) Instant consumption, where the power consumed at a certain moment in time is stored, and (ii) Power consumed, where the total power consumed during a certain period is provided.

To clarify this concept, the fridge used in 2.4 is used as an example. This appliance has an instance consumption of 104 W during periods of 16 minutes every hour and fifteen minutes approximately. Every time, the fridge starts consuming a *consumption notification* is sent to the Home Gateway. The HEMSOnt is updated and this information is stored in an *instant consumption* individual. For example, at the end of every day, the instant consumptions are added and a *power consumed* individual is created. Figure2.11 depicts this process and the two classes.

The creation of the individual *power consumed* is created by a SWRL rule: “if *end of the day*, then add all *instant consumption* for each device and create *Power Consumed*”. Relating the historical data with SWRL has two main advantages. Firstly, data is easily accessible and clearly organized at any moment a new rule can be created to calculate the power consumed following different variables. For instance, “if consumption takes place during *period*, and the device is *the appliance(s) of interest*, and *there was no one home*, create *power consumption*. As it can be seen from this example, the power consumption of one or more appliances can be easily calculated in function of determined conditions (in-home location, priority, etc.), i.e. $Power_Consumption = f(period, appliance(s), conditions)$. Secondly, granularity of data: Due to the fact that great amounts of data can be created to save detailed power consumption history. The *instant*

power individuals could be deleted after a certain period, i.e. when they are older than a month, and added into one *power consumed* individual. As this is also done by a SWRL rule, when this aggregation should be done and for what appliances can be easily modified at anytime.

2.4 Reduction of Power Consumption in Home Environments

In this section, the performance of the HEMS developed in this thesis is analyzed by using a high-resolution model of electricity demand for home environments. To test the HEMS, a set of basic rules, which aim to have no effect on the users' comfort, are implemented into the HEMSOnt. All rules will be evaluated every time the HEMSOnt is changed. For instance, if the Home Gateway receives a status update, the status of the device will be changed in the HEMSOnt, and then the Jess rule engine will evaluate and trigger the necessary rules. When a rule is triggered and a device in a home network has to change status, a message is sent to the target device by using the Manager bundle service and the corresponding Network bundle. In the case herein presented, all home appliances have been emulated and therefore contained in the emulated network.

2.4.1 Power Consumption Models

In order to test the HEMS herein described, information about how users interact with the appliances is needed. Most models simulating power consumption in home environments provide time-correlated power consumption for the entire dwelling. However, in order to test the HEMS detail information about when, how long and the instantaneous consumption of each device found in the home environment is needed. The model presented in [57] by Richardson et al. is used. This power consumption model is based on occupant time-use data, where occupant activity is mapped to appliance use. In the same way, detail information about light devices and its usage is also needed. To calculate the light usage, Richardson et al. take into consideration the solar irradiance. This model under-represents the demand during night, as it does not consider users leaving the lights on by mistake. In addition, this model provides time-correlated occupancy data, referred to as active occupancy. Active occupancy is defined as the number of people who are at home and awake, this data input is used to model the presence system, which will have status present when active occupancy

equals one or more.

Richardson et al. provide an Excel Workbook [58] containing a high-resolution model of domestic whole house electricity demand. This implementation is used to calculate the use of home devices within a single UK dwelling over a 24-hour period at a one-minute time resolution. The simulator incorporates models to calculate the active occupancy and lighting usage. This implementation offers the option to configure the day and month of the year, the total number of users that live in the dwelling and whether a week day or a weekend day is simulated.

2.4.2 Simulation Parameters

The energy management strategy for this test is based on a few basic rules in terms of occupancy and irradiance, which have been included in the HEMSOnt. Therefore, it has been assumed that the home network contains a *presence system*, which by using sensors can indicate the presence of users in the home premises. Light sensors are also used to detect the solar irradiance. The rules used are summarized below:

- Lights and irradiance threshold: If the irradiance detected by the light sensors in a room is higher than the threshold, the lights in that room are turned off. The threshold can be modified according to user preferences through the user interface.
- Lights and no presence: If the sensors detect that there is no one present, all the lights are turned off.
- Standby: Standby power consumption is one of the major energy savings areas as the appliances are consuming without performing any task. Therefore, this rule makes sure that appliances are either turned off or on, but never in standby mode.
- Appliance and no presence: some of the appliances at home can be turned off while the user is away, for instance the printer and Wi-fi router. A rule for each appliance that the user wants to turn off while away from home has been implemented. This rule can be extended to more or less appliances according to users' preferences.
- Appliance and presence: in the similar way some appliances only have to be turned on when the user is away from the premises, for instance the answering machine or alarm system.

Table 2.1: Energy groups

Energy group	Yearly Consumption range
Low	902-2173 kWh
Medium	2174-3273 kWh
High	3274-7743 kWh

Table 2.2: HEMS input parameters

Energy group	Consumption 28 days	Max-Min daily consumption	Estimated Yearly consumption
Low	147,114 kWh	4,32-6,14 kWh	1917,74 kWh
Medium	216,293 kWh	5,92-9,52 kWh	2819,53 kWh
High	361,000 kWh	10,96-17,36 kWh	4705,89 kWh

To test the work herein described, an occupancy of 4 people has been considered. Furthermore, Firth et al. [59] have defined three energy groups according to their annual electricity consumption: low, medium and high, as shown in Figure 2.1. 28 days have been simulated using Richardson et al. Excel Workbook [58] for the three energy groups. These 28 days are divided into four weeks (5 week days and 2 weekend days) of each season (Summer, Autumn, Winter and Spring). These data has been used as input into the developed HEMS. A summary of the input parameters used can be found in Table 2.2.

2.4.3 Results and Discussion

The results of the HEMS's performance for the three energy groups is summarized in Table 2.3. It can be observed that they are not directly proportional to the consumption. The high group energy, by using this HEMS implementation, could save 11,67% of their electricity consumption. On the other hand, the low priority class could save 21,66%. This difference is due to the fact that the rules in this HEMS implementation mainly reduce the standby power of appliances. As the total household consumption increases, the standby also increases, but at a much slower rate. Households in the high energy group consume more energy due to the fact that they use more appliances and spend more time at home than the low energy group. However, the reason for a higher number of appliances turned on depends on each case. For instance, there could be a family, in which they all watch

Table 2.3: Electricity Savings

Energy group	Consumption 28 days	Savings in 28 days	Estimated Yearly savings	Savings Percentage
Low	115,242 kWh	31,87 kWh	415,47 kWh	21,66%
Medium	177,957 kWh	38,336 kWh	499,74 kWh	17,72%
High	318,870 kWh	40,13 kWh	523,12 kWh	11,67%

TV in different rooms, and therefore little energy savings could be possible; or there could be a family where they leave the TV in the living room on, while they are in the kitchen making food, and therefore energy savings are possible. In order to achieve more energy savings, it is important to have context information. Sensor systems, to detect presence of users and sensors to detect environmental surroundings (for instance, temperature and sunlight) are an important part of this HEMS system. Even though energy savings are possible without this awareness, the HEMS system has limited energy savings capabilities as it can be seen from the results.

Furthermore, the lighting system considered here does not take full advantage of the HEMS as the model used does not provide enough detail information about the lights' and users' location. The model herein used simply defines whether it has a set of lights which are turned on and off following the model presented in [60]. This model does not provide information about the relationship between the location of the light and user and therefore saving energy rules related to lighting in this simulation are limited.

To introduce the lighting savings aspect into the simulation, the set of lights provided by the model have been randomly assigned one of the two types of rooms: *room with window* or *room without window* (following a 50% probability). A simple lighting rule has been introduced to the HEMS: "if the irradiance is higher than 300 W/m, and the light is in a room with windows, and there is someone in the house, then the light is turned off". It can be seen that this rule can be unrealistic in some cases, as the light in a certain room depends, not only on the present irradiance, but also on the size and orientation of the window. Furthermore, the user could be in the house but in a different room, and in this case the lights should be turned off to achieve more energy savings. Additionally, this model does not consider the situation in which a user simply forgets a light off when (s)he leaves to work or goes to bed. According to [61], up to 40% lighting energy cost savings can be achieved by introducing photosensors to take

natural light into account, and occupancy sensors to adjust lights based on occupancy detection. Therefore, the HEMS herein presented could provide more energy savings, in relation to the lighting system, by modifying the used rule in this simulation by two simple rules:

- “If the light in a *room* is higher than *amount*, and the *light* is on, and there is someone in the *room*, then turn off the *light*”; where *room*, *amount* and *light* can be set to each user’s preference. Furthermore, the user could chose to make a rule that applies to all rooms or a different rule for each room and light in the house.
- ‘If the light in a *room* is on, and there is no one in the *room*, then turn off the *light*’

More rules can be added to the HEMS regarding heating, ventilation, and air conditioning (HVAC) systems. In order to implement these rules and emulate their consumption, detailed information about the HVAC systems, home architecture and home isolation is necessary. This information is very specific for each home environment and it is not included in the model herein used. However, the authors in [62] have evaluated a home with four occupants and focused on HVAC and random human negligence periods. In their scenarios, they achieve energy savings of approximately 35% on HVAC. Therefore, if the HEMS herein developed would include rules regarding HVAC, more energy savings could be achieved. Rules regarding HVAC could be as simple as turn off HVAC when no one is in the room, or more complex. These rules could, for instance, take into account outside temperature and irradiance, and use actions like open/close window or shades to regulate the inside temperature and save electricity. Additionally, users’ schedule could also be used as an input parameter and then lower the temperature when the user is going to be away for a relatively long period of time, for example going to work for 8 hours.

2.5 Optimization of Power Consumption in Home Environments

Optimization or efficient power consumption refer to a distributed consumption that avoid demand peaks. As it has been state before, a scheduling algorithm has been implemented to schedule the appliances and spread their consumption over time. This system has been tested separately from the HEMS rules, as they are independent from each other. The HEMS rules

aim to reduce the total consumption of the household, whereas the scheduling algorithm aims at distributing the consumption (total consumption is the same with and without the algorithm). To analyze the performance of the scheduling algorithm the delay suffered by the low priority appliances is evaluated.

2.5.1 Simulation Parameters

A simplified scenario has been chosen to evaluate the delay suffered by the low priority appliances due to the fact that there is a limit on the maximum consumption and therefore, in some occasions these appliances will have to wait before they can consume power. This delay is referred to as *waiting time*.

As the priorities of appliances can considerably vary from user to user a simplified scenario that contains a television set, a computer, a washing machine, a dryer and a dishwasher has been considered. In addition, the appliances have been septated into these two priorities: high priority appliances (television set, computer) and low priority appliances (washing machine, dryer and dishwasher). The medium priority has not been considered in this simulation. The high priority appliances are considered to require electricity as soon as they are turned on, they cannot be denied power and cannot be paused or delayed in any way. On the other hand, the low priority appliances can be paused and/or delayed, as it has been considered that their task duration could be prolonged without affecting the users' comfort. This scenario has been evaluated separately from the energy management system, as it does not affect the total consumption; it only limits the instant power consumption.

The household appliances considered in this scenario are presented in Table 2.4. This table also includes the consumption of each appliance, the average usage of the appliance and the duration of this usage. The average usage of the appliance has been taken from [63]. This data attempts to model the appliances usage of a typical day of a family (4-6 persons) between 17:00-00:00, when most of electrical consumption takes place.

Two different scenarios have been taken into consideration: Scenario A, with maximum consumption of 1000 Watts or 4 channels, and Scenario B, with maximum consumption of 750 Watts or 3 channels. Both scenarios have a maximum consumption of over 733 W. The maximum consumption allows that all high priority appliances can be turned on at the same time and there is enough power for at least one of the low priority appliances to be turned on at a time. In Scenario A, one low priority and one high

Table 2.4: Home Appliances Characteristics

Appliances	Model	Power Consumption	Average Usage [63]	Usage Duration
Television Set	Television: 42LE4900 LG [64] DVD player: DVX550 LG [65] Home theater: S-HS111US Pioneer [66]	239 Watt	4,3 hours/day	120 min
Computer	PC: HP Pavilion Slimline s5670t [67] Monitor: BX2340 Samsung [36]	242 Watt	3,5 hours/day	100 min
Washing machine	WM12S32XEE Siemens [68]	733 Watt	3,1 times/week	131 min
Dryer machine	WTW8658XEE Bosch [69]	609 Watt	4,4 times/week	134 min
Dish washer	SMS69T25EU Bosch [70]	720 Watt	4,1 times/week	100 min

priority appliance can be switched on at the same time. In Scenario B, this is not possible; the low priority appliances and the high priority appliances cannot be switched on at the same time.

The impulsive noise in power line channels has been identified in [71] and in [72] to be caused by human interaction, i.e. turning on and off appliances. In addition, in [71], this noise has been characterized to approximately follow a Poisson distribution. Therefore, the requests from appliances are considered to arrive independently at random times and the interarrival times of flows are exponentially distributed, which results in a Poisson arrival process with specific arrival intensity.

2.5.2 Preliminary Analysis

The first study done of the scheduling algorithm for DR mechanisms presented here is done using teletraffic theory, which is typically used in network planning and it is used to obtain preliminary results. This simulations are used to make a first assessment on the scheduling algorithm and analyze its viability.

A MATLAB simulation, based on teletraffic theory, is used to calculate the approximate mean waiting time the low priority appliances suffer due to the limited maximum power consumption. Teletraffic theory aims to evaluate network performance deriving the relationship between grade-of-service (GoS), which is the probability of a service being blocked or delayed for more than a specific amount of time, and system capacity, which is the total bandwidth of the system [73]. Based on the traffic demand and the targeting GoS, the network capacity or bandwidth is defined.

A similar strategy is followed here for calculating the system's waiting time caused by limited maximum power consumption, which in teletraffic would be seen as bandwidth. More specifically, traffic management is accomplished by using a bandwidth allocation scheme named Reversible Fair Scheduling (RFS) [74,75] which provides dynamic allocation of resources depending on the power consumption they request. RFS is a unified approach

to multirate loss systems and delay systems.

In teletraffic, services request to use the system capacity. The system, depending on bandwidth availability, serves the request or makes the service wait until there is available bandwidth. In this article, there are two types of services: high and low priority appliances, which send request to consume power. The system capacity or available bandwidth is defined as the total maximum power consumption. The system capacity is divided into channels, which in this case would be equal to consuming 250 Watts.

RFS Implementation

The RFS algorithm implementation was done by Georgios Karadas, [76] in MATLAB. For each appliance, the arrival rate, the mean service time and the channels needed have been calculated, by using the data given in Table 2.4. The arrival rate is defined as the average rate of incoming requests to consume power from the appliances and the mean service rate is the time it takes for each appliance to finish its task. The number of channels represent the power needed by each type of appliance. The RFS algorithm parameters are summarized in Figure 2.13. Each channel represents 250 Watts. Considering the power consumption of the appliances, it has been assumed that high priority appliances use 1 channel (250 Watts) and low priority appliances use 3 channels (750 Watts). The consumption of the appliances used to evaluate the system are higher than the actual values. This is due to granularity precision within the teletraffic simulator software used. The maximum power consumption is available to all appliances independently of the appliance class they belong to. As long as an appliance is requesting a number of channels smaller than the available number of channels, it is granted power to consume. In contrast, if the channels are occupied then the system assigns a reduced amount of power. When the appliance works at a lower amount of power compared to the usual power, it is said that the appliance is in reduced mode. The algorithm, which defines how the distribution of power is taking place, is described in details in [74]. Enforcing this algorithm results on spreading the service load across time; in other words, distributing the power consumption over time. This means that after the reduction of resources, the service will take longer to complete, as depicted in Figure 2.12. This can become extremely useful when the home appliances that do not have to complete their task at a specific time.

The evaluation of the algorithm is focused on the waiting time of each appliance. The RFS allows an estimate of the mean waiting time of the low priority appliances. The mean waiting time is the additional time an

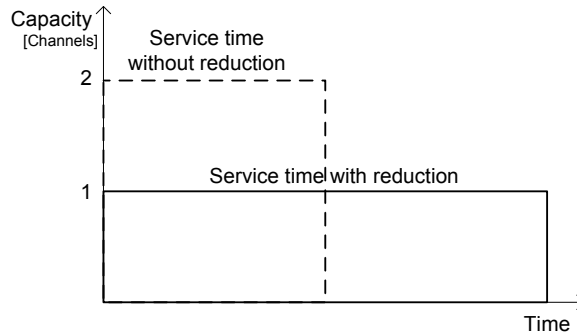

Figure 2.12: Spreading task completion over time

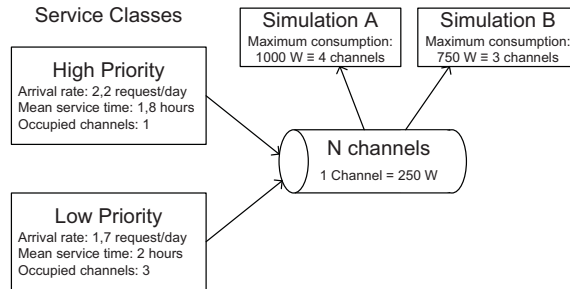

Figure 2.13: RFS Algorithm Schematic

appliance takes to finish its task compared to the normal mode, where no maximum power consumption is set. The appliances that are blocked, because the specified power threshold has been met, will be delayed or offered reduced power and their completion will be spread over time. The RFS implementation is described in [77], where the system is treated as a general processor sharing when the maximum consumption threshold is exceeded. This means that, in a real implementation, the home gateway is responsible of deciding which appliances should be allowed to consume by prioritizing them. This RFS algorithm implementation is used to estimate the mean waiting time of a system with the characteristic presented in Figure 2.13.

Furthermore, even though the low priority appliances need three channels, the RFS algorithm will allow the appliances to consume if any number of channels is available. Therefore forcing the appliance to consume less than they requested and prolonging its task time, as shown in 2.12. Nowadays, home appliances are not able to do so. However, a new appliance can be developed to take advantage of prolonging its task time to avoid demand peaks.

Table 2.5: Results RFS

	Scenario A	Scenario B
Max Consumption	1000 W	750 W
RFS Impl. mean waiting time	12,4 min	36,1 min

Preliminary Results

Two different scenarios have been taken into consideration: Scenario A, with maximum consumption of 1000 Watts or 4 channels, and Scenario B, with maximum consumption of 750 Watts or 3 channels.

The results for RFS implementation are shown in Table 2.5. The results presented in this table are the mean waiting times for the low priority appliances for both scenarios. The waiting time is the delay introduced by the scheduling algorithm due to the limited maximum power consumption. In Scenario A, which has maximum power consumption of 1000 Watts, the mean waiting time for low priority appliances is 12,4 minutes. In other words, the low priority appliances will take 12,4 minutes more to finish their tasks, which corresponds to a 10% time increase. For Scenario B, the mean waiting time is 36,1 minutes, which is higher than Scenario A as the maximum power consumption is lower, 750 Watts.

It has been considered that a 10% increase on the duration of a low priority appliance is a reasonable result considering the benefits. The customers will actively participate in DR and help avoid demand peaks and possible blackouts, in addition of receiving a monetary compensation [2]. Therefore, the scheduling algorithm has been implemented and integrated into the HEMS herein developed.

2.5.3 Simulation Parameters

The same appliances presented in section 2.5.1 have been introduced into the HEMS described in 2.3.3. In addition, two different cases are analyzed. In Case 1, it has been considered that the low priority appliances can be paused and their consumption is fixed, i.e. it cannot be reduced, as depicted in Figure 2.14. On the other hand, Case 2 considers that the appliances can be paused or, if necessary, their power consumption can be reduced to keep the appliance working under the maximum consumption, as depicted in Figure 2.15.

As in the preliminary analysis, two different scenarios have been taken into consideration: Scenario A, with maximum consumption of 1000 Watts, and Scenario B, with maximum consumption of 750 Watts. The requests

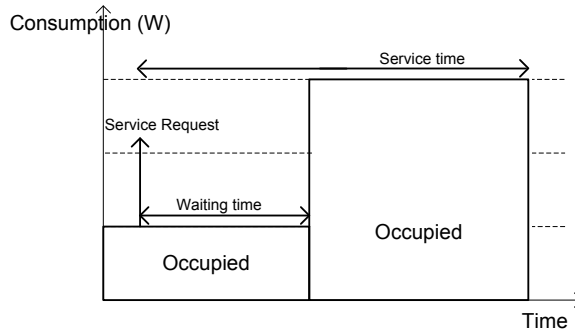

Figure 2.14: Shared Resources Example Case 1

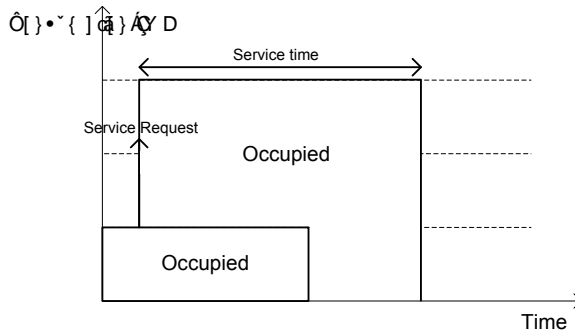

Figure 2.15: Shared Resources Example Case 2

from appliances are considered to arrive independently at random times and the interarrival times of flows are exponentially distributed, which results in a Poisson arrival process with specific arrival intensity. A 100 test cases of one day have been done for each scenario and case. The results of these simulations are described in the next section and compared to the preliminary results.

2.5.4 Results and Discussion

The mean waiting time of the low priority appliance for both scenarios and cases is summarized in Table 2.6. The waiting time is the additional time that the low priority appliances have taken to finish their task. For Scenario A of case 1, the washing machine will take on average 149,3 min minutes instead of 130 minutes, which means an increase of 14,8%. For Scenario B of case 1, the waiting time is considerably higher, 69,6 minutes, as when a high priority appliance is on, no low priority appliances can consume power and have to wait for the high priority appliance to finish. As it was expected,

Table 2.6: Results Scheduling Algorithm

	Scenario A	Scenario B
	1000 W	750 W
Case 1	19,3 min	69,6 min
Case 2	10,8 min	31,5 min

the waiting time is higher than the one obtained in the preliminary results. In this case, even though the maximum consumption is not reached, there are appliances that are waiting to consume power as they do not work in a reduced mode.

The results obtained in case 2 are similar to the ones in the preliminary result as expected. In case 2, it is assumed that appliances can work in reduced mode and therefore use more efficiently the resources provided, i.e. if the maximum consumption is not reached and there are appliances that want to consume, the appliances will work in reduced mode. However, this case is not yet possible with the existing appliances. Some appliances are offering the so called “eco mode”, during which all the appliance program the power to be reduced and spread over time. The appliances considered in case 2 would be the next generation of this “eco mode” appliances, where the power can be increased or decreased depending on the rest of the household’s electricity demand. In this case the delay caused by the fixed maximum consumption is 8,4% for scenario A and 24,5% for scenario B. It is also important to highlight that pausing appliances occurs in a minority of the simulations. In this case, 95% of the times, the appliances go to reduced mode and not to pause.

Case 2 will be better accepted by end users as they fulfill the same requirements than case 1, but offer less waiting times, and therefore are less likely to disturb users’ comfort.

2.6 Conclusion and Further Work

There is a need for a Home Energy Management System (HEMS) to reduce residential consumption and also to reduce demand peaks and get users involved in Demand Response (DR) mechanisms. This chapter has provided an introduction to HEMS, where the objectives, requirements and issues have been identified. Following this considerations, a Home Gateway for a HEMS has been developed. In order to test its performance, additional HEMS components, such as Smart Meter and Energy Rules Server, have also been implemented.

To offer context-aware information to the HEMS, ontologies have been used to model the environment. The HEMSOnt is based on DogOnt and extended to cover energy management concepts not provided in DogOnt, such as power consumption and priority. A price class has also been added to the DogOnt. However, this class is very basic and could be extended to better model the price information provided by the utility.

The energy management strategies offered by the HEMS herein developed are: monitoring, rule-based policies and scheduling algorithm. The herein implemented rules for energy management are basic and limited. However, the system is easily configurable and more rules can be added by using the Energy Rules Server. Additional rules that could be added could deal with electricity price, HVAC and other more complex aspects that would depend on the users' preferences. An example of such a rule could be: "If the price kWh is higher than *certain amount* and the user is in the living room, then *dim or even turn off* some of the lights in the living room". In order for this rule to be included in the system, it has been assumed that the HEMS will include sensor subnetworks that can provide the necessary context information.

Another type of rules that could be implemented in this HEMS is "advice-rules". This type of rules would not have any effect in the system, but could be used as a test run of the rule. For instance, if a user is uncertain about whether a rule is suitable for his/her system, the rule could be included in the system as an advice-rule. Every time this advice-rule is triggered, a message would be printed in the graphical user interface. This message would include a description on the action it would have been taken in the case the rule was inserted into the system. In this way, the user can evaluate if the rule is relevant and if it suits his preferences.

The scheduling algorithm has been implemented as a separated bundle in the home gateway and uses queries to obtain the necessary information about the system. However, this scheduling algorithm could be implemented in SWRL. Furthermore, this scheduling system has been analyzed by using a subset of the home appliances 2.5 and tow priorities. Further testing with more appliances and more priorities should be done to fully analyze the effects of this algorithm.

Even though it is clear that the herein HEMS can be improved, the home gateway prototype for a HEMS serves as a proof of concept and fulfils the initial specification described in 2.1.1. The herein presented HEMS architecture and Home Gateway offer the user the means to control the home devices, monitor and manage the household power computer with a

technology independent platform.

The HEMS solution that herein provided is based on an open platform which includes and allows:

- Power consumption monitoring model: per device basis and overall consumption which:
 - It is technology independent.
 - Gathers power consumption information with configurable granularity. However, this information is not displayed in the user interface. Further work in this aspect is needed.
 - Scalable (provide different levels of granularity/information: home, building, suburb, city): even though home environments have been used through the thesis, the HEMS system developed can be easily scaled to buildings. The main difference between home environments and building environments, in the context of HEMS, is the number of devices and the energy management strategies approach. Due to the fact that energy rules are used to manage the power consumption and that those can be easily adjusted to the users/context preference, the energy management system herein presented could be scaled to a building. In a similar way, the scheduling algorithm herein presented could be scaled into managing building or suburbs total consumption.
- Managing the power consumption of the household devices in an automatic or manual way. The user can manually control the house appliances and manage the energy management strategies from the graphical user interface developed. Automatic control of household devices is provided by using a context-aware system (implemented with an ontology) and rules. The user can configure this system to be more or less automatic and/or energy efficient by downloading energy rules from the Energy Rules Server through web services.
- Communication with the electricity producer and distributor to offer all or some of the following services:
 - Advanced Metering Infrastructure: communication with the smart meter and the home gateway is provided by using webservices. However, the herein system has not developed a system that neither communicates nor offers billing information to the user. Further work in this aspect is needed.

-
- Demand response: as explained in Section 1, residential automatic participation in DR mechanisms is foreseen to be one of the domains with most repercussions when trying to reduce demand peaks. The scheduling algorithm in the system proposed here helps reduce demand peaks by limiting the total consumption in the household during peak hours.
 - Additionally, remote control is provided through webservice. In addition to monitoring and controlling devices, this remote access enables the user to change the settings of the energy management system and the scheduling algorithm.

Chapter 3

Smart Grid Communication

3.1 Introduction

The National Academy of Engineering acknowledges the power grid as the supreme engineering achievement of the 20th century, due to its ingenious engineering, its support for other technologies and its impact in improving quality lifestyle for society [78]. However, the power grid has not changed significantly during the last century (the average substation transformer age is over 40 years old [79]). The power grid was designed to provide one-way flow of electricity and centralized generation. Furthermore, the actual power grid has limited automation and situational awareness and there is a lack of customer-side data. Therefore, an upgrade is needed to achieve efficient energy distribution and production and to fulfil the new power grid functionalities. Upgrading and introducing ICT in the power grid will lead to the so called Smart Grid. The Smart Grid will include new components and functionalities to efficiently manage the electricity distribution and production. In addition, efficient distribution and production of energy requires knowledge about consumers' energy demand. Collecting data on the energy consumed in households can help build up statistical information about consumption patterns. By providing this knowledge to the utilities, they can foresee the energy needs of their consumers and avoid electricity shortages or blackouts.

In order to collect all these data, a cooperation between consumers and utilities has to be established. This cooperation involves incorporating a bidirectional communication system between utilities and consumers. Consumers will also benefit from this communication as utilities can provide them with real time information about electricity price and billing status.

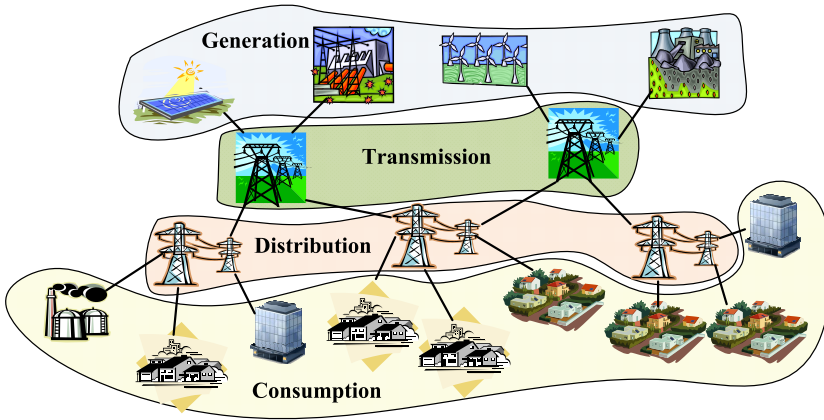

Figure 3.1: Power Grid Architecture Overview

Having access to these information, the consumers may become more conscious about their electricity consumption and they may try to reduce the associated costs by avoiding peak hours, leading to a more distributed and efficient consumption. Utilities can also make direct request to consumers to reduce their demand when demand peaks occur. This communication system will enable utilities to be proactive, acting before the problem occurs instead of reacting to it. In addition, there will be no need for having utilities employees coming to read the electrical meter as that information will be obtained through this communication system providing Advance Metering Reading (AMR).

3.1.1 Power Grid Architecture Overview

The power grid is an interconnected electricity network, which includes infrastructure of power generation, power transmission, power distribution and control. A typical power grid system is illustrated in Figure 3.1. A brief description of the different sections of the power grid is provided below.

- **Generation:** it is composed of different types of power generators, such as coal, fossil fuels, natural gas, nuclear, wind turbines and hydraulic power plants among others. The main part of the electricity generated comes from large power plants located in strategic locations. For instance, a coal power plant could be found near a coal mine. This section of the power grid is responsible for generating enough power to supply the demand.
- **Transmission system:** it carries electric power in an efficient way from

the power plants to the distribution. Transmission system may span a hundred kilometers and line voltages are above 100 kV in Europe. The electricity is transmitted at very high and high voltages to reduce the energy losses in long distance transmission. The power plants are connected to the transmission system by a substation or transformer. A substation contains circuit breakers, switches and transformers, which step-up or step-down the voltages in the lines. Furthermore, substations can be found through the transmission system to change the voltages in the lines.

- **Distribution system:** it is similar to transmission system as their function is to carry electricity. However, the distribution system carries the electricity from the transmission system to the consumers. This system includes medium and low voltages and also contains substations to interconnect it with the transmission system and through the distribution system. The voltage in the transmission system lies between 69 kV and 240 V in Europe.
- **Consumption system:** it is composed by residential, commercial and industrial consumers. The consumers are equipped with an electricity meter that registers the household power consumption. Consumers may be found in rural, suburban or urban areas. Moreover, industrial consumers may be connected to the distribution grid at power levels higher than 240 V.
- **Control Centers:** In the traditional power grid, the system operation and maintenance is done through centralized control and monitoring, Supervisory Control and Data Acquisition (SCADA). The control centres communicate with the substations found around the power grid through private microwave radio, private fiber and public communication network which provide limited information [80].

The actual power grid architecture is centralized and unidirectional, from the generation to the customers and does not take into consideration deployment of renewable energies, such as photovoltaic panels or solar thermal panels, which are increasing in the distribution section and in the home environment. These renewable energies could help reduce the consumers' power consumption from the grid and, if excess of electricity is produced, they could insert it into the grid.

Furthermore, it is expected that electric vehicles will replace fuel vehicles. These new electric vehicles are going to be equipped with a battery

that will be charged directly from the grid. The current power grid may not be capable of support, such an increase of power consumption, and should be upgraded to make sure blackouts do not occur due to overload.

3.1.2 Objective

The focus will be on the Low Voltage (LV) distribution grid in Europe, as the power line communication under study in this thesis is between the customers and the transformer station, namely the so called access domain [7]. In Europe, three phase configuration (three hot wires and one return or ground) are common and only one of the phases is fed to each house. Up to 350 households can be connected to a single transformer station, which may have more than one transformer present depending on the load. Up to ten branches may leave the transformer station serving approximately 30 households each.

The objectives set for this second part of the Ph.D.:

- Research the Smart Grid concepts and its objectives
- Study the possible communication technologies that could be used for Smart Grid communication
- Propose a network architecture for Smart Grid
- Study the viability of the network proposed

3.2 The Smart Grid

The Smart Grid concept is used by the different players involved in the power grid, not only utilities, but also governmental entities. However, there is no standard definition. Different definitions exist, some functional, some technological, and some benefits-oriented:

- European Technology Platform (ETP): ETP defines the Smart Grid as “an electricity network that can intelligently integrate the actions of all users connected to it - generators, consumers and those that do both -in order to efficiently deliver sustainable, economic and secure electricity supplies” [81].
- European Commission: European Commission defines the Smart Grid. It is “an electricity network that can efficiently integrate the behaviour and actions of all users connected to generators, consumers and those

that do both in order to ensure an economically efficient, sustainable power system with low losses and high levels of quality and security of supply and safety” [82].

- Electric Power Research Institute (EPRI): “The term Smart Grid refers to a modernization of the electricity delivery system so it monitors, protects and automatically optimizes the operation of its interconnected elements from the central and distributed generator through the high-voltage network and distribution system, to industrial users and building automation systems, to energy storage installations and to end-use consumers and their thermostats, electric vehicles, appliances and other household devices” (EPRI) [83].
- US Department of Energy (DOE): “An automated, widely distributed energy delivery network, the Smart Grid will be characterized by a two-way flow of electricity and information and will be capable of monitoring everything from power plants to customer preferences to individual appliances. It incorporates into the grid the benefits of distributed computing and communications to deliver real-time information and enable the near-instantaneous balance of supply and demand at the device level” [84].

The Smart Grid is still an open concept. However, from these definitions it can be seen that the Smart Grid will enable a more dynamic, resilient, sustainable, efficient and adaptable grid with new capabilities and will involve the participation of different players, from customers to utilities. The Smart Grid will not only supply power, but also information and intelligence. As the European Technology Platform (ETP) states “the smartness is manifested in making better use of technologies and solutions to better plan and run existing electricity grids, to intelligently control generation and to enable new energy services and energy efficiency improvements” [85].

Furthermore, NIST has developed a Framework and Roadmap for Smart Grid Interoperability Standards which “presents the first steps of a Smart Grid interoperability framework based upon initial standards and priorities to achieve interoperability of Smart Grid devices and systems” [3]. Additionally, it provides a conceptual architectural reference model shown in Figure 3.2. This model divides the power grid into domains, actors and applications. There are seven domains, which are further divided into sub-domains. Each domain is a high-level grouping of actors, organizations, individuals, systems or devices which have similar objectives and may have

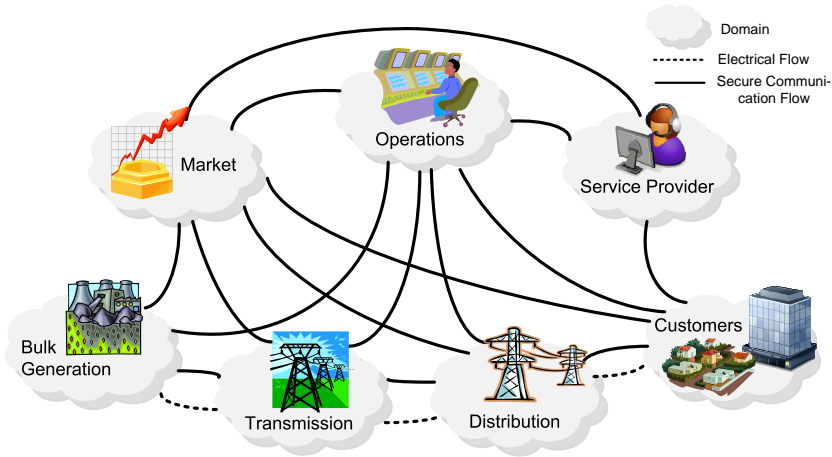

Figure 3.2: NIST Reference Model [3]

overlapping functionality. NIST defines actors as devices, systems, or programs which are capable of making decisions, exchanging information and interacting with actors from the same or other domains. The tasks performed by one or more actors are defined as applications. In the following, there is a brief description of each domain and also some of the identified interfaces by NIST for which interoperability standards are needed.

- **Bulk Generation:** More renewable energy resources will be deployed into the Smart Grid. The main actors in this domain are big power plants, such as renewable variable sources (solar and wind), renewable non-variable (hydro, biomass and geothermal) and non-renewable (nuclear, coal and gas). This domain may also include energy storage for later distribution of electricity.
- **Transmission:** Similar to the electricity transmission system today, this domain carries electricity over long distances. However, a two-way communication system will be deployed in substations and other intelligent devices found inside this domain, which will make it substantially different from the current one.
- **Distribution:** The main change to the distribution is the two-way communication system for monitoring and controlling. It may also include storage of energy and connection with alternative distributed energy resources (DER), such as wind farms and solar panels systems.
- **Customers:** In the Smart Grid, customers will be capable of generating, storing and managing the use of energy as well as the connectiv-

ity with their plugin vehicles into the power grid. In this conceptual model, the smart meters, besides being able to control and manage the flow of electricity to and from the customers, will provide information about energy usage and consumption patterns. Consumers will have a two-way communication with utilities and other third parties.

- **Markets:** Markets domain includes the operators and participants in electricity markets, such as market management, DER aggregation, retailing, wholesaling and trading among others. This domain is in charge of coordinating all the participants in the electricity market and ensuring a competitive market, in addition to exchanging information with third-party providers. For instance, roaming billing information for inter-utility plug-in-vehicles could be an example of a third-party service.
- **Service Providers:** This domain handles all third-party operations between domains. Examples of actors in this domain are installation and maintenance, billing, customer management and other emerging services. Through this domain customers and utilities can exchange data regarding energy management.
- **Operations:** Operations domain is in charge of managing and operating the flow of energy through the power grid. It is connected to customers, substations and other intelligent devices through a two-way communication. Actors included in this domain are metering reading, maintenance and construction, security management and network operations among others. This domain provides monitoring, reporting, controlling and supervision status, which is important to obtain a reliable and resilient power grid.

The European Technology Platform (ETP) network vision of the Smart Grid is shown in Figure 3.3. ETP does not define domains. However, it identifies the stakeholders involved, which may include governmental entities, consumers, traders, transmission and distribution companies, ICT providers and power equipment manufactures among others. Their vision for the Smart Grid includes a two-way communication among these stakeholders which will provide coordination at regional, national and European level. ETP expects deployment of intelligent devices and distributed energy resources along the power grid. Furthermore, the European Commission identifies the following challenges for enabling Smart Grid deployment in Europe that have to be addressed [86]:

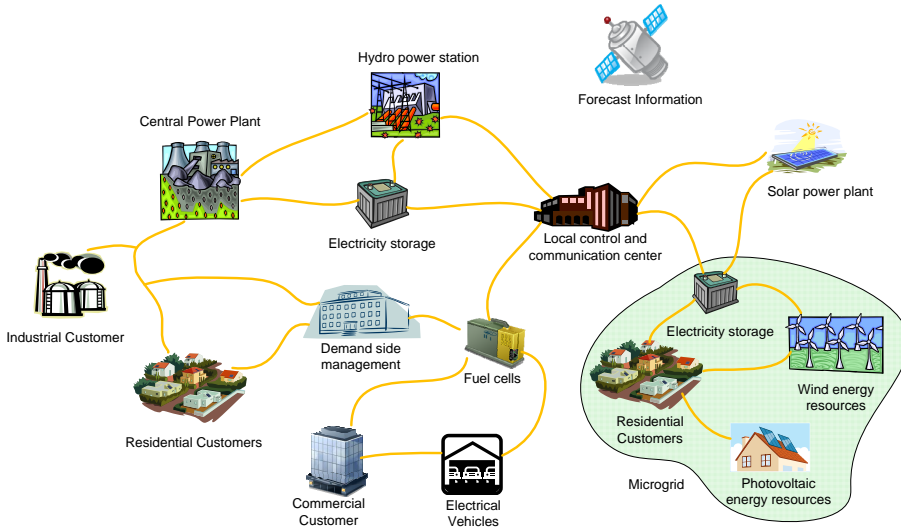

Figure 3.3: ETP's Smart Grid Vision [4]

- Developing common European Smart Grids standards.
- Addressing data privacy and security issues.
- Regulatory incentives for Smart Grids deployment.
- Smart Grids in a competitive retail market in the interest of consumers.
- Continuous support for innovation and its rapid application.

3.2.1 Smart Grid Objectives

One of the main objectives of the Smart Grid is to make the power grid more efficient and to incorporate renewable energies. These objectives can help reach the targets set by the European Commission. Figure 3.4 summarizes the main high-level objectives the Smart Grid should fulfil. When designing the Smart Grid these goals should be taken into consideration and be integrated together in order to maximize the benefits.

- Enable the active participation of consumers: In the Smart Grid, customers will become active participants and will play a role in optimizing the operation of the system. The grid may request the consumers to reduce their consumption to avoid shortages and reward them with economical benefits. This process is referred to as Demand

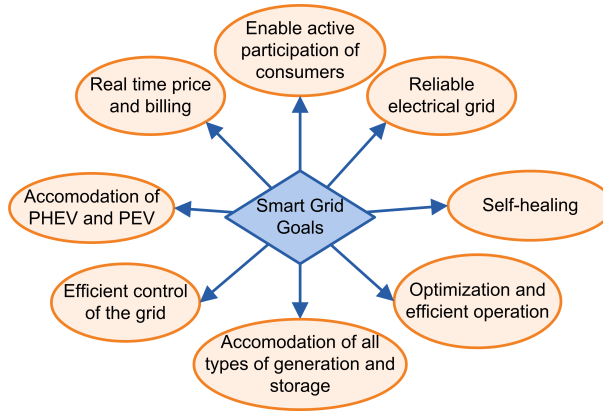

Figure 3.4: Main High-Level Objectives

Response (DR). DR will help utilities shape the demand according to the available production. Enabling this interactive service network in the power grid will improve the efficiency, safety and reliability of the electricity transmission and distribution [84]. Moreover, customers are installing renewable energies in their premises and the Smart Grid should be capable of accepting these injections into the grid. Consumers in the Smart Grid that consume and generate energy will be called prosumers (*pro*-duces and *con*-sumers).

- **Reliable, resilient and robust grid:** The Smart Grid should improve security and quality of supply and reduce the number of blackouts and shortages to increase system reliability. In order to achieve a more resilient, reliable and robust grid than the actual power grid, the Smart Grid should be easily re-configurable and dynamic; in other words, it should be a self-healing system.
- **Optimization and efficient operation:** Optimization and efficient operation of the grid implies a reduction of energy losses in power grid. Moreover, the Smart Grid should significantly reduce the environmental impact of the whole electricity supply system and improve the grid infrastructure operation. This can be achieved by upgrading the grid components and by using consumption statistics to foresee the electricity usage. It should also embody efficient and reliable alarm and fault management for self-healing procedures.
- **Accommodation of all types of generation and storage:** The Smart Grid has to accommodate from large centralized power plants to re-

newable energies installed in the customers' premises or distribution systems. In addition, it is foreseen that new storage systems, such as community storages, may be included in the Smart Grid. To properly manage and control these new components, the Smart Grid should be designed as a decentralized and distributed grid to better facilitate the connection and operation of generators of any capacity and technology.

- Efficient control of the grid: Introducing ICT into the power grid can help collect real-time data about the consumption, production and grid status. This information can be used to achieve efficient control of the power grid to balance loads and avoid blackouts and electricity shortages.
- Reduce carbon emissions: The European Commission Climate Action set three energy targets to be met by 2020, known as the “20-20-20” targets, which are [12]:
 - A reduction in EU greenhouse gas emissions of at least 20% below 1990 levels
 - 20% of EU energy consumption to come from renewable resources
 - A 20% reduction in primary energy use, compared with projected levels, to be achieved by improving energy efficiency.

The carbon emissions can be reduced by incorporating some of the already mentioned objectives:

- Reduce network losses by using more efficient components
 - Facilitate penetration of renewable energies, such as wind turbines and photovoltaic cells, installed in the distribution grid or in customers' premises.
 - Improve operational decisions in the power grid by using weather forecast to estimate the production of solar and wind farms. Also, load forecast will make the power grid more efficient.
 - Use DR to reduce or even avoid demand peaks. [87] presents a system, where the house consumption is kept under certain limit to avoid demand peaks.
- Accommodation of PHEV and PEV: Even though Plug-in Hybrid Electric Vehicles (PHEVs) and Plug-in Electric Vehicles (PEVs) are

not yet wide-scale adopted, they should be taken into consideration when designing the Smart Grid. It is foreseen that the amount of PHEV and PEV will increase, which will lead to a considerable increase of electricity demand which cannot be supported by the current power grid.

- Real time price and billing: ICT will provide the means to transmit real time price and billing information to the customer. Furthermore, the consumers will be provided with greater information and options for choice of power supply.
- Microgrid operation mode: Microgrids are generally defined as low voltage grids, which can range between a few hundred kilowatts to a couple of megawatts, and include distributed generation sources, storage devices and consumer side. The ETP defines a microgrid as “a controlled entity which can be operated as a single aggregated load or generator and, given attractive remuneration, as a small source of power or as ancillary services supporting the network” [4]. Although microgrids mainly operate connected to the rest of the power grid, they can automatically switch to island mode when faults occur, avoiding shortages or blackouts in the microgrid area. Later on, when the fault is stabilized, microgrids should re-synchronize with the rest of the power grid with minimal service disruption. During islander mode, the microgrid’s main functionality is to balance the distributed resources with local energy loads. Therefore, microgrids are capable of taking a decision locally, while operating in islander mode. When the microgrid is connected to the power grid, coordination with the rest of the power grid is necessary. Microgrids provide a new level of flexibility in configuring and operating the power grid, which may make the grid more efficient, reliable, resilient and dynamic.

3.2.2 Smart Grid Functional Areas

The high level objectives described in the previous subsection can be classified into the six functional areas defined by DOE [8] in which most Smart Grid applications fall:

- Advanced Metering Infrastructure (AMI): refers to the infrastructure capable of measuring and collecting power consumption and generation at the consumer side and communicating it, in a two-way communication flow, to management system which makes this information

available to the service provider. AMI allows utilities to collect metering information via a communication network with customers and to analyze energy consumption data for grid management, outage notification and billing purposes. Additionally, AMI can provide real-time price and billing information to the customers.

- Demand-Response (DR): is a reduction of consumption by the consumers, residential users, commercial or industrial as a response to high electricity prices or to a direct request from the utilities in order to reduce heavy loads in the system. By using DR systems, demand can be shaped to follow the production and therefore shortages and blackouts can be avoided. Furthermore, renewable energies, such as wind energy, have very variable power output depending on weather conditions. DR can help balance such loads providing a more flexible and dynamic power grid. However, accepting a power reduction request is voluntary and can create some operational complexities.
- Wide-Area Situational Awareness (WASA): is a set of technologies that will enable improved reliability and prevention of power supply disruption by monitoring the grid status. WASA systems include sensors, which monitor the status of different elements in the power grid, intelligent devices, which can trigger an alarm in case of a critical situation, and two-way communication with the service providers. The main objective of WASA is to provide information about the grid status on real time. WASA will transform the power grid into a proactive system, which will prevent critical situations instead of reacting to them.
- Distributed Energy Resources (DER): extends from distributed renewable energy sources to electric vehicle batteries, combined heat and power (CHP), uninterruptible power supplies (UPS), utility-scale energy storage (USES) and community energy storage (CES). It is expected that DER will be deployed along the power grid, especially on the consumers' side and distribution system. Integrating DER into the power grid involves a major change as it implies decentralized generation and multi-directional flow of electricity, from utility-to-consumer, from prosumer-to-utility and even prosumer-to-consumer. DER applications require a more complex control situation and effective communication technologies to keep the balance in the power grid.

Table 3.1: Smart Grid Objectives relation to Smart Grid Functional Areas

Objectives \ Functionalities	AMI	DR	WASA	DER	ET	DGM
Active participation of customers	✓	✓	-	✓	✓	-
Reliable and secure supply	-	-	✓	-	-	✓
Self-healing	-	-	✓	-	-	✓
Optimization and efficient operation	-	-	✓	✓	✓	✓
Accommodation of all types of generation and storage	-	-	-	✓	-	✓
Efficient Control	-	✓	✓	-	✓	✓
Reduce Carbon Emissions	-	✓	-	✓	✓	✓
Accommodation of PHEV and PEV	-	-	-	✓	✓	-
Real-Time price and billing	✓	-	-	-	-	-
Microgrid operation	-	-	✓	✓	✓	✓

- Electric Transportation (ET): plug-in hybrid electric vehicle and plug-in electrical vehicles will drastically change the users' consumption. This change of load has to be taken into consideration when designing the Smart Grid, which has to provide sufficient energy supply for electric vehicles and effectively manage the demand. This new kind of vehicles also offers the potential to function as storage devices, thus helping balancing the load in the Smart Grid by reducing the demand in energy shortage periods and absorbing the demand during excess supply periods.
- Distribution Grid Management (DGM): involves decentralized and remote control of the components found in the power grid. By using real time information about the power grid status and by being able to remotely control the power grid, the Smart Grid becomes a more reliable power grid. Furthermore, distribution and substation automation are part of the distribution Grid Management, which will provide more effective fault detection and power restoration. Supervisory Control and Data Acquisition (SCADA) and Distribution Management Systems (DMS), examples of DGM, require centre based control and monitoring systems in order to coordinate the power grid and keep balance.

Table 3.1 matches the presented objectives to be fulfilled by the Smart Grid in Section 3.2.1 and the above functional areas.

3.3 Smart Grid Communication

Further changes in the power grid Grid components have to be done to successfully fulfil the functionalities provided in the previous section. Advanced components, advanced control methods and improved decision support will be introduced in the power grid as it moves towards becoming the Smart Grid. In addition, sensing and measurements technologies should also be incorporated to evaluate the correct functionality of all elements in the grid and enable efficient control. Introducing ICT into the grid is one of the main steps to transform the power grid into the Smart Grid. The aim of ICT in the Smart Grid is to provide more information about:

- Consumption: detailed knowledge about energy demand of the consumers will help create consumption patterns. The utilities can then foresee the energy needs of their consumers and avoid electricity shortages or blackouts. ICT can also be used to collect real-time consumption data to maintain the equilibrium between consumption and production.
- Production: Deployment of renewable energies, such as photovoltaic panels, is increasing in home environment and in the distribution system. Monitor and control is necessary for an efficient power grid.
- Status: Real-time monitoring the grid will help detect critical situations. Remote control of the grid's component will help solve or even avoid these situations.
- Electricity price and billing status: Having access to real time price and billing information will make the users become more conscious about their electricity consumption and they may try to reduce the associated costs by avoiding peak hours, leading to a more distributed and efficient consumption.

This communication will benefit both parties: it will provide customers with information about the real-time electricity prices, billing status and utility requests; and it will provide utilities with real-time data of the electricity consumption of their customers. The data collected by the utilities can also be used for efficient control, which will provide an optimization and efficient grid operation by reducing the carbon emissions; integration of distributed energy resources; microgrid operation, in case part of the distribution grid needs to operate in stand-alone mode to avoid power shortages;

Table 3.2: Communication Requirements for Smart Grid Functional Areas [8]

Functional Areas \ Communication Requirements	Bandwidth	Latency	Reliability	Security	Backup Power
Advanced Metering Infrastructure	10-100 kbps per node 500 kbps for backhaul	2-15 sec	99-99.99%	High	Not necessary
Demand-Response	14-100 kbps per node	500 ms-several minutes	99-99.99%	High	Not necessary
Wide-Area Situational Awareness	600-1500 kbps	20 ms-200 ms	99.999-99.9999%	High	24 hour supply
Distributed Energy Resources	9.6-56 kbps per node	20 ms-15 sec	99-99.99%	High	1 hour
Electric Transportation	9.6-100 kbps	2 sec-5 min	99-99.99%	Relatively high	Not necessary
Distribution Grid Management	9.6-100 kbps	100 ms-2 sec	99-99.999%	High	24-72 hours

and integration of plug-in hybrid electric vehicles (PHEVs) and plug-in electric vehicles (PEVs), which will have a major role in the consumption in customers' premises.

3.3.1 Communication Requirements

US Department of Energy (DOE) has written a technical report, Communication Requirements of the Smart Grid [8], which encloses the communication requirements based on the projections of future communications needs and the input of the different actors involved in ICT for the Smart Grid. Table 3.2 summarizes the Communication requirements found in this report.

However, this thesis focuses on two main functional areas: Advanced Metering Infrastructure and Demand Response. Therefore, the area of interest is the communication in the access domain between customers and utilities. AMI and DR need a network that collects energy consumption and generation information at the customers' side and communicates it to the utility. The customers' data is collected data by the smart meter, which is installed at the customer's premises. The smart meter acts as an access point and transmits this information to the utility. The energy consumption data can then be used by the service provider and utilities for grid management, outage notification and billing purposes. Customers can benefit from this communication as they will be able to access their real-time consumption, avoid having a utility employee coming to read their electricity meter and obtain real-time price per kWh and their billing status. Moreover, DR systems can be as simple as changes in electricity price. By providing customers with real-time price information, it is expected that they will operate most of their appliances when the prices are low and will reduce their consumption when prices are high. Authors in [88] show the results of such a DR system. However, more complex DR systems can be designed. Two other DR programs are proposed by the authors in [89]:

- **Incentive-Based DR Programs:** The utilities will send reduction requests or mandatory commands to customers, who will benefit from a reduced electricity price in case they accept this request.
- **Demand Reduction Bids:** In this case, the customer starts the interaction with the DR system by sending a demand reduction bid to the utility. The bids would normally include the available demand reduction capacity, the duration of the reduction and the price during that period.

ICT for AMI and DR has to fulfil some basic requirements to be successful. These requirements have been identified and listed below:

- **High Connectivity and flexibility:** All electricity customers should be able to communicate with the utility. Due to the fact that more and more devices, such as smart meters, will be added to the power grid when moving towards the Smart Grid, ICT for AMI and DR should be flexible to enable this.
- **Scalability:** Due to the fact that there are considerably large amount of nodes to be connected to this bidirectional communication network, especially in urban areas, the solution to enable this exchange of information has to be easily scalable [90].
- **Network Ownership:** Some utilities have expressed their preference for using their own communication networks rather than commercial networks to support Smart Grid technologies [8]. This can lead to a segmentation and heterogeneity in the ICT in the Smart Grid.
- **Interoperability:** As stated above, it is foreseen that the Smart Grid will involve different actors, different utilities and third party providers. Therefore, any communication solution has to take into consideration interoperability problems and facilitate the integration among the different communication systems.
- **Deployment Costs:** As electricity providers may want to have their own private communication network. Some of these possible communication technologies, such as fiber optics or licensed wireless communication systems, may have too high deployment costs for the utilities. Therefore, the solution to connect customers with utilities has to take this fact into consideration.

- **Security:** The data transferred from customers to utilities has to be transmitted through a secure network, where utilities can prevent and detect unauthorized access and/or corrupted data. This network will carry private information, information for billing purposes and grid control data, therefore a high level of security has to be ensured [91]. Additionally, DR messages can be used for load management, so it is important to verify the integrity of the information exchanged. Efficient security mechanisms should be included in the Smart Grid communication to avoid cyber attacks.
- **Privacy:** Communication between customers and utility should be encrypted to maintain customers' privacy and avoid passive attacks, which aim to collect the consumption information provided by customers to the utilities. Therefore, the data regarding consumption should be protected when transmitted through the Smart Grid.
- **Data Ownership:** Data ownership is closely related to privacy issues. This information may be of interest to different entities, which the user might not be interested to share, as they can extract patterns of home activity from metering data; for example, which devices they own, when do they use them and lifestyle routines can be deduced from the users' load profiles. One may think that the data should be owned by the customers and they should agree to share it with third parties or not. On the other hand, this data is crucial for utilities as it can be used to forecast consumption and improve the power grid efficiency. However, these two statements are not mutually exclusive.
- **Latency:** According to the Communications Requirements of the Smart Grid Technologies report from DOE [8], it is expected that latency requirements for communications between customer and utilities should be between 500 ms to several minutes for DR and 2 to 15 second for AMI.
- **Bandwidth:** It has been estimated that the bandwidth required for AMI will be between 10 to 100 kbps per node. However, communication among the aggregation point and the utility will likely have bandwidth requirements in the 500 kbps range [8]. DR has similar requirements, although, they may vary depending on the sophistication of the system.
- **Quality of Service:** The information transferred in AMI and DR is related to the real-time consumption and DR requests, which is directly

related with the grid status. This data can be considered critical, therefore the supporting communication network must support the quality of service (QoS) [92].

Issues and Challenges

The Smart Grid is a system of systems which involves different actors and has different functional areas that require ICT. Deploying ICT will require that these parties work together to obtain the maximum benefits. This may require data interfaces between the different parties that ensure interoperability. Integrating ICT into the grid may require (1) deploying a new communication infrastructure in the grid, (2) standardizing the communication between parties, (3) fulfilling all the necessary requirements for the Smart Grid applications.

Some of the barriers the stakeholders have to overcome when developing ICT for the Smart Grid are:

- Diversity of available technologies: There are different available communication technologies that can implement the ICT in the Smart Grid. This leads to a diversity of possible architectures, which can cause division in the power grid. Interoperability between the different actors involved in Smart Grid communication is one of the most important communication requirements, which will require standardization of machine-to-machine communication.
- Different entities: There are different players involved in the development of the Smart Grid [93]. It is important that these entities can communicate with each other and exchange information in order to achieve the objectives and functionalities of the Smart Grid. However, due to the fact that there is diversity of available technologies and different protocols for machine-to-machine communication, interoperability between the different entities involved in the Smart Grid is becoming a challenge.
- Different functional requirements: The different functionalities have different requirements and require communication between different players, which is a challenge to incorporate the ICT into Smart Grid as more than one communication networks may be needed.
- Security: As Smart Grid will enable remote control of the power grid elements, security becomes an issue. The ICT incorporated into the

Smart Grid should be resilient to cyber attacks. Furthermore, as the consumption data of consumers is transmitted through AMI, data authenticity should be ensured.

- **Privacy:** Detailed private information about the consumption in consumers' premises will become available in the Smart Grid. This information may be of interest to different entities, which the user might not be interesting to share, as they can extract patterns of home activity from metering data; for example, which devices they own, when do they use them, and lifestyle routines can be deduced from the users' load profiles. Therefore, the data regarding consumption of users should be protected when transmitted through the Smart Grid and maybe restricted to only some entities.
- **Data Ownership:** Data ownership is closely related to privacy issues and is still a topic under discussion. One may think that the data should be owned by the consumers and they should agree on whether to share it with third-parties or not. On the other hand, this data is crucial for utilities, as it can be used to forecast consumption and improve the power grid efficiency. However, these two statements are not mutually excluding. A solution could be that load profiles of consumers are owned by the user, but aggregated data of load profiles can be used by utilities for consumption forecasting.

3.3.2 Communication Technologies

Many communication and networking technologies can be used to support Smart Grid applications. Also considering the Smart Grid's different functionalities with diverse requirements, it is likely that this will lead to a deployment of a variety of communication technologies creating a mesh network. However, the focus on this thesis is the physical network that will connect the customers with the utilities to provide a secure and reliable network for AMI and DR.

WiMAX is the most promising wireless technology for AMI and DR [94] compared to Wireless LAN, cellular networks and other short range wireless, such as Bluetooth and ZigBee, as it provides sufficiently high data rates and large distance coverage.

WiMAX [95] is a wireless mesh network and therefore offers flexible networks which are characterized by their self-healing, self-organization and self-configuration capabilities. These functionalities enable increased com-

munication reliability and good network coverage. Due to this characteristics, WiMAX could be a candidate for AMI and DR [94]. In addition, WiMAX supports IPv4 and IPv6 clients and application servers.

In general, wireless technologies offer fast deployment and low installation. However, this is not the case for WiMAX where towers are expensive. Moreover, WiMAX working at frequencies over 10 GHz cannot penetrate buildings, which is a main concern as smart meters will probably be located inside. Lower frequencies could be used for WiMAX, but these ones have already been licensed and in order to utilize them third parties should be involved [94].

Power Line Communication (PLC) seems to be the most suitable technology for AMI and DR, as part of the Smart Grid is underground or not accessible [96]. PLC can have some drawbacks in North America, as only one to three customers are connected to a transformer, which would considerably increase the deployment cost. However, in Europe, around 100-300 customers can be connected to a single transformer, which makes PLC a good candidate.

The main drawback of PLC is the power line medium, as it is especially difficult to ensure a given QoS [97]. This is due to the power line characteristics: unpredictable frequency and time dependence of impedance, impulse and background noise, attenuation and transmission characteristics of the cable [96].

According to their working frequency band, the current available PLC technologies can be divided into [98]:

- Ultra-Narrow Band (UNB): These technologies operate in the Ultra Low Frequency [300-3000 kHz] band or in the upper part of the Super Low Frequency [30-300Hz] band and achieve very low data rate, around 100 bps. However, they have a very large operational range, 150km or more. UNB technologies are usually proprietary and very mature. However, they do not offer sufficient bandwidth to be used for AMI and DR.
- Narrow-Band (NB): These technologies operate in the Very Low Frequency band, Low Frequency band and Medium Frequency band [3-500kHz] and can be divided into:
 - Low Data Rate (LDR): It includes single carrier technologies with data rates of less than 10 kbps. The market already offers products that work in this frequency range which are usually used for home or building automation.

- High Data Rate (HDR): It includes multicarrier technologies with data rates between tens of kbps and up to 1 Mbps.
- Broadband (BB): These technologies operate in the High Frequency and Very High Frequency bands (1.8-250MHz) with data rates ranging from several Mbps to several hundred Mbps. These technologies are also known as Broadband over Power Lines (BPL).

In addition, in Europe and the US, governmental entities have considered PLC as a candidate technology for Smart Grid applications. Therefore, a specific frequency band has been defined for PLC in order to provide harmonization in the market. The Comité Européen de Normalization Electrotechnique (CENELEC) issued the EN 50065 [10] standard, which allows communication over Low Voltage (LV) distribution power lines in the [3-148.5] kHz frequency range in Europe. Furthermore, it divides this frequency band into 4 frequency subbands:

- A band: 3-95 kHz, reserved to power utilities.
- B band: 95-125 kHz, any application.
- C band: 125-140 kHz, in home networking systems with mandatory CSMA/CA protocol.
- D band: 140-148,5 kHz, alarm and security systems.

In the US, the Federal Communications Commission (FCC) defines the [10-490] kHz frequency band for general supervision of the power system by an electric public utility [99]. High Data Rate Narrowband communications seem to offer enough bandwidth for AMI and DR communication and have a reserved frequency band in Europe and North America. This communication technology has been considered one of the most suitable technologies to be used for AMI and DR. The advantages of narrow band PLC, with a focus on the AMI and DR requirements, are summarized below:

- Easy to deploy: Electricity wiring already exists and therefore no additional infrastructure is necessary. The main requirement is to deploy smart meters with PLC capabilities at the customers' premises and introduce PLC transceivers in the power grid, such as in transformers and substations. Depending on the distance between the users' premises and the substations, repeaters or relays may be required along the network.

- Deployment costs: Traditionally, substations at the Low Voltage level are not equipped with communication capabilities [100] and deployment of new infrastructure introduces high cost for utilities. As power line cables connecting the actors involved in AMI and DR are already deployed, PLC is the only technology that has deployment costs comparable to wireless.
- High connectivity and extensive coverage: All the actors involved in AMI and DR are connected to power cables. Therefore, via a PLC network, the parties involved are connected into the AMI and DR communication network. This is an additional advantage for substations and customers in rural areas where there is usually no data communication infrastructure.
- Easily scalable: As the communication network is created, new customers and other actors can be added to the network by simply deploying a PLC transceiver.
- Redundant communication channel: AMI and DR may require redundancy in protection and control, which implies the need of available redundant communications channels. Depending on the power grid topology, which changes among countries, PLC technology can offer the necessary mesh topology for redundancy.
- Network ownership: As power lines are owned by utilities, a PLC network offers utilities direct and complete control of the network. This is advantageous especially on countries where telecom markets are deregulated.
- Capacity: Most Smart Grid functionalities require between a few hundreds of kbps and a few Mbps. PLC seems to offer the necessary bandwidth needed for these applications.
- Transformer penetration: NB-PLC transmission, unlike BB-PLC, is able to "penetrate" transformers, however with a substantial SNR hit. Nevertheless, this capability depends on the transformer itself. So, if new transformers are deployed, the SNR degradation to the PLC signal should be taken into consideration.
- Ease to upgrade to future versions: Low obsolescence time for any new infrastructure is preferred. NB-PLC devices can be implemented by

using a Digital Signal Processing (DSP,) whereas this is not possible with BB-PLC solutions [100].

- Special bandwidth reserved for utilities: FCC and CENELEC have defined a NB frequency range to be used by utilities for Smart Grid functionalities. Furthermore, some countries, have prohibited the use of frequencies above 2 MHz in outdoor environments [100], which is the frequency band used by BB-PLC.
- Optimized design: BB-PLC solutions, such as IEEE 1901 [105] or ITU-T G.hn, were originally developed for home networking and broadband Internet access, and not for Smart Grid functionalities.

Different narrowband PLC are available: PRIME, G3-PLC, IEEE 1901.2 and G.hnem. G.hnem has been chosen as it has been based on PRIME and G3-PLC and has been enhanced to outperform those two technologies. In addition, G.hnem has been specially designed for Smart Grid communications [106]. However, G.hnem also poses the following disadvantages:

- New Standard: Even though some PLC technologies have passed the experimental phase and are mature technologies, G.hnem has just started their final stages of standardization and has not reach the mass market penetration.
- Interference: G.hnem and IEEE 1901.2 [107] work in the same frequency band and power lines are a shared medium, which can cause interoperability problems. However, interference among devices can be solved by using co-existence mechanisms, such as those defined in ITU-T G.9972 recommendation [108].
- Harsh and noisy channel: The power line medium is difficult to model, it is frequency selective, time-varying and is impaired by coloured background noise and impulsive noise.
- Power grid topology: Creating a PLC network for AMI and DR can be challenging as the grid structure differs from country to country and also within a country and more than one utility may be providing electricity to customers.

Furthermore, following the Open Systems Interconnection (OSI) model, G.hnem defines the physical layer, data link layer and a convergence layer for IP. G.hnem supports transport of IPv6, which is an advantage as most information exchange standards designed for Smart Grid, such as C12.22 [101]

and C12.19 [102], DLMS/COSEM [103] and Smart Energy Profile (SEP) 2.0 [104], are based in IP. IP-network will be an effective solution that will provide the necessary flexibility for the communication in the Smart Grid, in addition to reducing the cost of deployment and maintenance [109]. However, to meet the latency requirements and reduce security vulnerabilities, the Smart Grid network should be de-coupled from the global Internet [110], as it has been proposed in this thesis.

There are various on-going data models for Smart Grid technologies that can be transmitted over IP networks. However, this can depend on utilities and smart meters manufactures, and each region or country may chose different data models for the exchange of information. The network architecture proposed can support different data models. Some of the possible standards for AMI and DR are:

- ANSI C12.19: A common data structure used for encoding data in communication between end devices and utility enterprise. It defines a set of standardized tables and procedures using extensible markup language (XML) notation. The procedures are used to invoke actions in the meter and tables provide a method to store the collected meter data and control parameters. The latest version of C12.19 has been extended to provide Smart Grid functionalities, such as Time-Of-Use function and the Load Profile function.
- DLMS/COSEM (IEC62056): It defines an interface model and communication protocols for data exchange with metering equipment. This standard is based on the client/server paradigm and the information is transported via IP networks. The model represents the meters as a server and the clients may be utilities or customers (home gateway). The client applications can retrieve data and provide control information. DLMS/COSEM is designed to support smart meter functions, such as load management, customer information, event management, revenue protection and data security.
- CIM: The Common Information Model (CIM) defines data structures to allow the application software to exchange information about the configuration and status of the power network. CIM defines a common vocabulary and basic ontology for aspects of the power grid. This standard is based on different IEC standards:
 - IEC 61970-301: defines the core packages, with a focus on the needs of electricity transmission, where related applications in-

- clude energy management system, SCADA, planning and optimization.
- IEC 61970-501 and 61970-452: define an XML format for network model exchanges using Resource Description Framework (RDF).
 - IEC 61970: provides application program interfaces for Energy Management Systems(EMS).
 - IEC 61968: is used for related applications of the electrical distribution system, which includes distribution management system, outage management system, planning, metering, work management, geographic information system, asset management, customer information systems and enterprise resource planning.
- MultiSpeak: is similar to IEC 61968, as it focuses on the data exchange modelling and enterprise integration in electric utilities. Data models are formulated by using XML schema. The data transport is implemented by using web services and Web Services Description Language (WSDL) files to document the methods and define which messages are required.
 - Smart-Energy Profile (SEP) 2.0: It is developed to create a standard which will include metering, pricing and demand-response load control.

3.4 Proposed Architecture

The objectives of the herein presented architecture are to provide the utilities with real-time data of the electricity consumption of their customers and the customers with information about the electricity price, billing status and utility requests.

Figure 3.5 provides a representation of the proposed communication system to provide this exchange of information. The home network encloses the communication among the home devices, which are interconnected by the home gateway, as explained in the previous chapter. The home appliances can range from lighting systems and home appliances, such as washing machine and dishwasher, to PEV and renewable energy systems, such as solar panels.

The Home Energy Management System, described in Chapter 2, is connected to the Neighborhood Area Network (NAN) by the smart meter using

Power Line Communications. At the utility end of the NAN, the Aggregator Unit, collects the consumption data of the customers of that NAN, aggregates it and forwards it to the Utility Control Center through the utility private network. By sending the aggregated data to the utility, the customer privacy is maintained and this data can still be used for DR systems and consumption forecasting.

The Control Center may accommodate the Meter Data Management System (MDMS), which will handle the aggregated consumption data. This data can be used in the Demand-Response system, which could also be contained in the Utility Control Center. The control center can send a request and/or price variations to the Aggregator Units, via the utility private network, or directly to the users' home gateway via the Internet. Using the Internet connection, utilities can provide billing information to their customers or authorized third party providers. The Utility Control Center can also use third party providers to improve the Smart Grid efficiency. For instance, the control centre could connect to meteorological data providers, which can supply the utility with data that can help forecast the energy production, such as wind speed, wind direction, temperature and sun radiation, among others. Additionally, this Control Center should be connected to other Control Centers, to the grid transmission and generation system to provide the DR system with the necessary information to achieve load balancing and avoid demand peaks.

Additionally, the Aggregator could have an active role in the DR systems, by having enough intelligence to run local DR algorithms. The Aggregator could take decisions locally in the NAN, and therefore the complexity of the DR system could be reduced. By using this architecture, these units could have knowledge of the DR in the area and they could help the DR system by decentralizing some of the DR tasks. For example, the Aggregator Unit may choose to forward reduction requests to only some customers, the ones with higher likelihood to accept the request, which may reduce traffic in the PLC network.

3.4.1 Neighborhood Area Network

The technology proposed for the interconnection between the Aggregator Unit and the customers' smart meter is G.hnem [111]. G.hnem is an ITU-T recommendation that aims to provide support for grid to utility meter applications and other Smart Grid applications through Power Line Communications (PLC).

By using PLC for customers-utility communication, high connectivity,

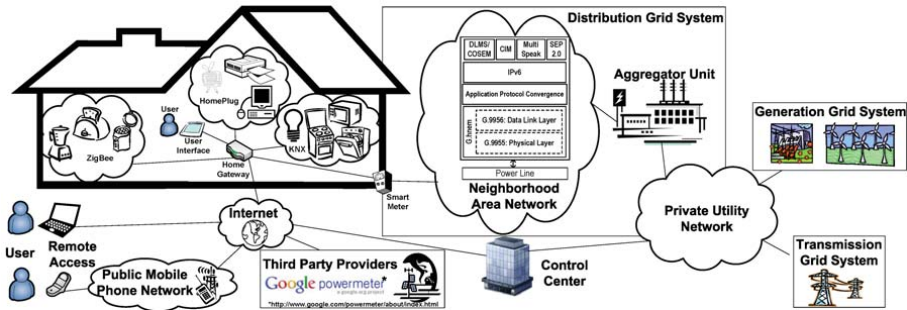

Figure 3.5: AMI and DR Communication Architecture Overview

network ownership and deployment cost requirements, which are fulfilled as the power line cables are already deployed, they are owned by the utility and they connect all electricity customers.

G.hnem technology is a Narrowband High Data Rate Power Line Communication (NB-HDR PLC), which uses OFDM technology and is able to penetrate through transformers. It also includes a robust transmission mode for harsh environments and a Forward Error Correction (FEC) based on Reed-Solomon. Other advantages of G.hnem are its high robustness, low complexity and low power consumption. G.hnem can work between 3-95 kHz.

G.hnem can simultaneously support different networking protocols, IPv6 among them. This can be seen as a step forward towards interoperability, as most data models designed for the Smart Grid can be transmitted over IP networks. The data models, which are used in the communication among the different actors in the AMI and DR network, need to also be standardized to ensure interoperability. However, this can depend on utilities and smart meter manufactures, and each region or country may chose different data models for the exchange of information. The network architecture proposed can support different data models.

3.5 ITU-T G.hnem Recommendation

G.hnem [111] standard started in January 2010 as a project within ITU-T Study Group 15 with the original title "Home Networking Aspects of Energy Management", which changed "Narrow-band OFDM Power Line Communication Transceivers" in 3 December 2010. G.hnem consisted of two ITU-T Recommendations: G.9955 [112], which was a physical layer specification and G.9956 [113], which was data link layer specification, for narrow-band

Orthogonal Frequency Division Multiplexing (OFDM) Power Line Communications transceivers. G.hnem entered the final stages of approval in April 2011 and a pre-published version was released in December 2011, which was used in this thesis. In December 2012, the contents of the two recommendations, ITU-T G.9955 (2011) and ITU-T G.9956 (2011), had been reorganized into Recommendations ITU-T G.9901, ITU-T G.9902, ITU-T G.9903 and ITU-T G.9904, which are technically equivalent.

The G.hnem recommendation supports indoor communication, which refers to home and building networking and outdoor communication for distribution power grid networking. G.hnem aims to address home area networking (HAN), utility meter applications, such as AMI, and other Smart Grid applications, such as electric vehicle (EV) applications.

G.hnem was designed to work in the frequency bands defined by the Comité Européen de Normalization Electrotechnique (CENELEC) [10] and Federal Communications Commission (FCC). CENELEC allows communication over Low Voltage (LV) distribution power lines in the [3-148.5] kHz frequency range in Europe. In the US, the [10-490] kHz frequency band was defined as general supervision of the power system by an electric public utility by FCC. In this thesis, only the transmission in CENELEC A band, which is reserved for power utilities, is considered. Therefore, only the parameters for this frequency band are analyzed and explained in the following sections.

3.5.1 G.hnem Network Architecture

A G.hnem network can be divided into one or more domains. A domain is a logical group of nodes, therefore domains may physically, fully or partially, overlap. The domains are identified by a 16-bits *Domain ID*, which is unique inside the G.hnem network. Furthermore, a G.hnem network may contain alien domains, which are any group of non-G.hnem nodes connected to the G.hnem network through a bridge node. A G.hnem network can consist of up to 65535 domains ($2^{16} - 1$) and each domain can contain 32767 nodes ($2^{15} - 1$). Each node is identified by a unique 16-bits *Node ID* inside a domain. In a G.hnem network, nodes can be extended to provide none, one or more of the following capabilities:

- Global Master (GM): Each network has a GM, which coordinates the operation, resources, priorities and operational characteristics of different domains in the network.
- Domain Master (DM): Each domain shall contain a domain master

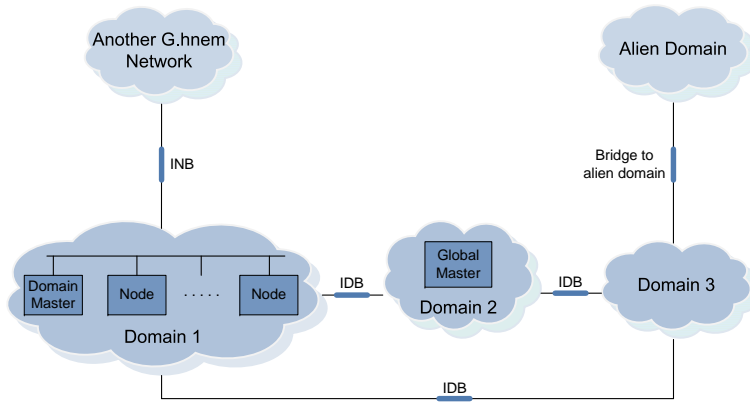

Figure 3.6: G.hnem Generic Network Architecture

(DM), which manages and coordinates the operation of all nodes in its domain. It is not required that all nodes are domain master capable. However, there has to be exactly one domain master at all times.

- **Inter-Domain Bridge (IDB):** IDB nodes enable communication between nodes belonging to different domains inside the same network.
- **Layer 3 Bridge (L3 bridge):** The main function of this type of bridge is to connect an alien domain with a G.hnem domain and to coordinate both domains to avoid mutual interference. However, these functionalities are beyond G.hnem scope.
- **Relay node:** Relay nodes have the capability to be used when direct communication among nodes is not possible.
- **Domain Access Point (DAP):** This type of node is not compulsory in a G.hnem domain. It is only found in a domain if the domain works in centralized communication mode. The DAP receives frames from all the nodes in the domain and forwards them to the corresponding destination node.

Figure 3.6 shows the generic network architecture for G.hnem and some of the nodes described above.

In a G.hnem network, nodes can communicate with each other directly or through other nodes. Therefore, mesh, star and tree topologies are supported by G.hnem. In the G.hnem standard, 3 types of communication are defined:

- Peer-to-peer communications (P2P): Nodes can only communicate with each other directly. If a node wants to communicate with a node outside the domain, frames are sent to the corresponding IDB.
- Centralized Mode (CM): This type of communication requires a domain access point (DAP). Hence, any node in the domain that wants to communicate with another node has to do it through the DAP node. In general, the DAP node is also the domain master; however, this is not compulsory. If a node cannot reach the DAP with direct communication, nodes acting as relays are used. Communication between nodes is not allowed in case of DAP failure.
- Unified Mode (UM): Nodes in a domain can communicate directly or via relays. IDB receive all the frames that have to be sent to nodes outside the domain.

3.5.2 G.9956 Data Link Layer Specification

G.9956 describes the DLL and defines its parameters. The DLL layer is in charge of creating the MAC Protocol Data Unit MPDU from the upper layer frames, which can be, for instance, IPv6 or IPv6 6LoWPAN compressed. Nodes can also exchange Link Control Data Units (LCDU), which are management frames exchange between LLCs. Other functionalities of this layer are encryption, retransmission and relaying. The data link layer is divided into 3 sublayers, as shown in Figure 3.7, and described in more detail in the following subsections.

Application Protocol Convergence

The Application Protocol Convergence (APC) is the link between the upper layers and the DLL layer. The incoming frames from the upper layer have to meet the defined format by the particular application protocol. By default, the APC will support an interface for IPv6; nevertheless, other data frames can be supported, such as IPv6 6LoWPAN compressed. A node may implement up to 8 parallel APC layers, each linked to a different application protocol.

However, this simultaneous support is optional. The bridging function between APC and the corresponding application protocol shall be implemented by the application entity and is out of the scope of this standard.

The incoming Application Data Primitives (ADPs) from the upper layers are converted into Application Protocol Data Units (APDUs) when

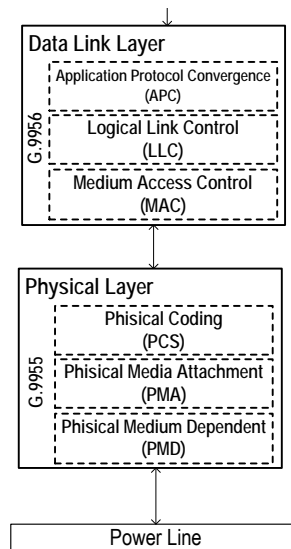

Figure 3.7: G.hnem Protocol Reference Model

transmitting, and APDUs are converted back to ADPs when receiving, as shown in the Figure 3.8.

This layer classifies the APDU according to the class of service provided by the DLL management layer. Quality of Service (QoS) is offered by enabling different classes of service that are classified according to four priorities. The highest, priority 3, can only be used for emergency data transfers. The priority assigned to an APDU depends on the application protocol and can be between 2 and 0. If no information is provided regarding QoS, the assigned priority is 0, which is the lowest. Furthermore, internal management communications are always assigned priority 2.

Address resolution between G.hnem addresses (Domain ID and Node ID, 32 bits) and IPv6 (16-octet) and vice versa is done by the DLL management and passed to this layer by using management primitives.

Link Layer Control

This sublayer can generate the LLC frame from two types of frames: APDU, received from the APC sublayer, and Link Control Data Units (LCDU), not shown in Figure 3.8, received from the DLL management. LCDU frames are exchanged between DLL management layers of nodes in the same network. LCDUs consist of one or more Management Messages (MM), which is formed by a Management Message Header (MMH) and a Management

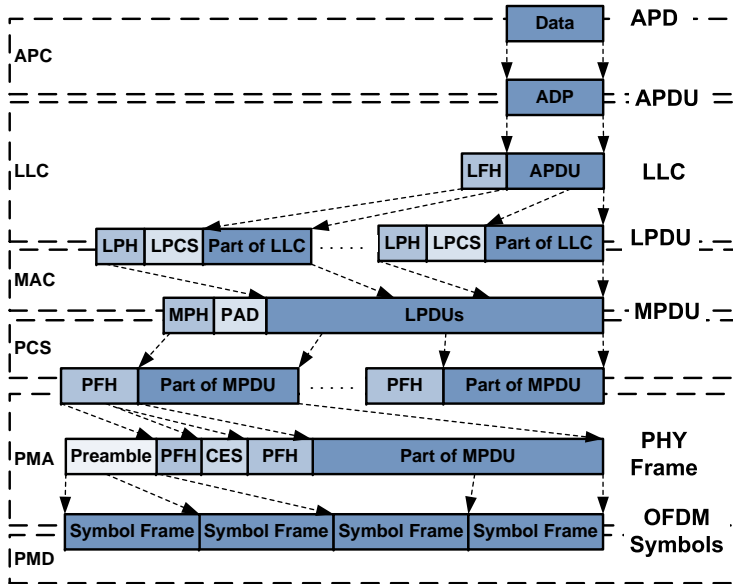

Figure 3.8: G.hnem Protocol Reference Model

Message Parameter List (MMPL). These frames carry management data and when received, they are submitted to the DLL management instead of the APC sublayer. As stated in the previous section, this type of frame has the highest priority in a non-emergency state.

LLC frame contains LLC frame header (LFH), which contains information about the LLC frame, such as the LLC frame type, whether the frame is encrypted or not and sequence number. LFH also contains a mesh header used only when relay mode communication is used and it contains the number of hops the LLC frame is allowed to be relayed, the originator and final destination address. The length of the mesh header depends on the type of address used.

When transmitting, the LLC frames are divided into equal sized segments, where a LPDU header(LPH) and LPDU check sequence (LPCS) are added to form the LLC Protocol Data Unit (LPDU) frame, as shown in Figure 3.8. The LPCS is used to detect corrupted LPDUs and consists of a 32-bit Cyclic Redundancy Check (CRC) computed over the whole LPDU frame using the generator polynomial: $G(x) = x^{32} + x^{28} + x^{27} + x^{26} + x^{25} + x^{23} + x^{22} + x^{20} + x^{19} + x^{18} + x^{14} + x^{13} + x^{11} + x^{10} + x^9 + x^8 + x^6 + 1$. The LPH consists mainly of a sequence number, which identifies the order of the segment within the LLC frame. The next step in the Data Link Layer is to assemble the LPDUs into MAC Protocol Data Units (MPDUs).

The encryption method used in this recommendation is based on Advanced Encryption Standard(AES) following NIST FIPS PUB 197 [114] and Counter Mode with Cipher Block Chaining Message Authentication Code Protocol (CCMP) following NIST SP 800-38C [115]. The Message Integrity Code (MIC) is used for frame authentication and CCMP header contains the necessary information to facilitate decryption. However, this functionality is optional and only the payload of the LLC is encrypted. In this thesis, it has been considered that encryption is used to protect the customers' data, therefore a 32 bits MIC has been used in the transmission. The overhead introduced by the DLL header and the encryption is 280 bits, where 40 bits correspond to the CCMP header and 32 bits to the MIC.

In addition, the Link Layer Control is also responsible for providing the following functionalities:

- **Acknowledgement:** When receiving, this sublayer generates acknowledgement (ACK) frame when necessary. The ACK frame does not have any payload and two types exist in this recommendation: the MPDU acknowledgement and LPDU acknowledgement (also referred as selective acknowledgement). An ACK is requested by using a flag in the Physical Frame Header. Another flag in the MPDU Frame Header (MFH) indicates the type of acknowledgement required. If an MPDU ACK is requested, the receiver will send an ACK, if all the LPDU contained in the MPDU are error free or a Negative ACK (NACK) if any of the LPDUs are corrupted. The LPDU ACK is used to acknowledge the LPDU independently. If the MPDU is not error free, the receiver will send a NACK indicating the corrupted LPDUs in the MPDU and will wait for the LPDUs to be retransmitted. If a received MPDU was previously received correctly, the receiver will discard it and reply with the requested type of ACK, even if the repeated MPDU has errors. If an LLC frame requires acknowledgment, all the MPDUs segments composing the LLC frame also have to require acknowledgement.
- **Retransmission:** When a NACK is received, the transmitter shall suspend the transmission of other MPDUs, if the priority of the MPDU being transmitted is equal or lower than the priority of the requested retransmission. In case an ACK frame is not received for a particular MPDU or LPDU before the timeout expires, the transmitter will discard the LLC frame and notify the failure to the upper layers.
- **Relay:** In this recommendation, two relay modes are allowed: Layer

2 relaying (L2) and Layer 3 routing (L3). L2 is done by relaying the LLC frames, whereas L3 routing is done by the upper layers. If relaying is allowed and a multi-hop frame is received (the node is not the final destination), the node will use its relaying database (routing tables) to transmit the packet to the next hop. However, the relay node transmits the LLC frame after all its compromising segments are properly received. The LLC frame is "de-segmented" to obtain the information from the LLC frame header, and then segmented again into LPDUs and forwarded to the next hop. Layer 2 relaying capabilities are optional, and therefore not all nodes in a domain, where Layer 2 relaying is enabled, can act as relays.

- Reception time limit: Segments belonging to a LLC frame have to be received inside a limited period of time. If the period expires, all the previously received segments of this LLC frame shall be discarded.

Media Access Control

In this sublayer, the MPDUs are assembled/disassembled into/from the LPDUs. The MPDU are then scheduled for transmission using one of the medium access procedures. The MPDU may contain up to 16 LPDU belonging to the same LLC frame. Each MPDU starts with the MPH and, as the G.hnem does not accept any MPDU length, pad bits are used when necessary. The MPH contains information about the LPDU length, the pad length and the source and destination Node ID among others. The MPH is 15 bytes long including 1 byte CRC computed using the generator polynomial: $G(x) = x^8 + x^5 + x^4 + x^3 + x^2 + x + 1$.

The medium access is defined in terms of contention period (CP). For each CP, nodes that have an MPDU to be transmitted, calculate the contention window (CW), which depends on the priority of the MPDU. CW is basically a back-off timer multiple of Idle Time Slot (ITS). If the medium is free when CW runs out, the node can start transmitting. Once the transmission of the MPDU has finished and if the transmitter specifies it, an acknowledgement frame is sent. If an acknowledgement is not necessary, the next CP starts. The CW value is calculated according to the MPDU priority determined by the APC and is updated after each attempt to transmit. Furthermore, if a node has a new packet to send and no transmission has been detected for a defined period of time, the node can immediately transmit.

The G.hnem standard also defines burst transmission which consists of

transmission of multiple PHY frames, each carrying an MPDU associated with the same LLC frame and each MPDU consisting of a single LPDU. The first MPDU of the burst shall be transmitted as described above using CP. The next MPDU of the burst shall be transmitted after a certain period of time from the previous MPDU.

The G.hnem also defines synchronous beacon, asynchronous beacon and beaconless operation modes, chosen at the initialization of the domain. The domain master uses beacons, which are special management frames, to control and maintain the domain.

3.5.3 G.9955 Physical Layer Specification

G.9955 describes the PHY layer and defines the transmission configurations. From the perspective of a communication protocol stack, the MPDU received from the Data Link Layer is encapsulated into a Physical frame. The Physical frame consists of a preamble, PHY-frame header, Channel Estimation Symbols (CES) and payload, which is composed fully or partially of the MPDU bits, $b_{payload} \leq b_{MPDU}$ bits. The preamble symbols are used for frame detection and synchronization and also, together with CES, for channel estimation. The PHY-frame header contains relevant information of the frame such as payload modulation or forward error correction parameters. This frame is then encoded, modulated and transmitted. This process has been divided into a number of steps represented by functional blocks.

The PHY layer main functionalities are: create PHY frames from MPDU, encode the PHY frames, and modulate the OFDM symbols. This layer is also divided into 3 sublayers as shown in the Figure 3.7: Physical Coding Sublayer (PCS), Physical Media Attachment (PMA) and Physical Medium Dependent (PMD). These three sublayers are explained in the following subsections.

As this thesis only studies the applicability of G.hnem in Europe, only the characteristics of G.hnem for CENELEC A band are presented in the following subsections.

Physical Coding

This sublayer provides data flow control between the MAC sublayer and the PHY layer. It also encapsulates MAC Protocol Data Units (MPDU) to be transmitted into PHY frames and it extracts the MPDU of the PHY frame received. When transmitting, it adds PHY frame header (PFH) to

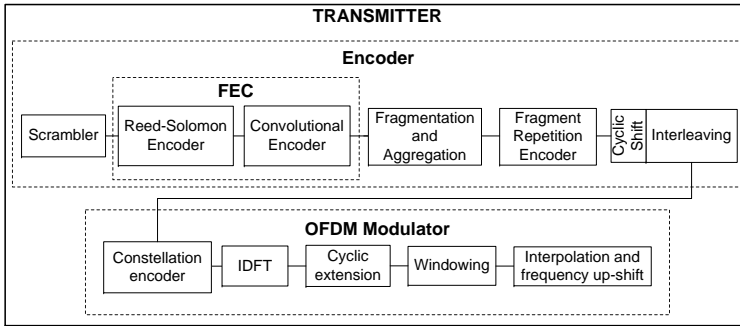

Figure 3.9: G.hnem Transmitter Functional Blocks

each PHY frame and when receiving, the PFH extracted from the PHY frame is processed to acquire the relevant frame parameters for decoding and submitting to the PHY management.

G.9955 defines several types of PHY frames depending on the frame purpose. There are four types of frames: Type 1: with payload, Type 3: without payload and Type 2 and 4: reserved by ITU-T.

G.hnem standard offers different modulation schemes and error correction bits among other encoder parameters. The G.hnem MAC layer is in charge of selecting the most appropriate parameters using information from obtained from previous transmissions to the same receiver(s), by using the SNR feedback or from the information given from upper layers. The transmitter is able to dynamically change to provide the best compromise between throughput and efficiency.

Physical Media Attachment

The PMA, when transmitting, is in charge of encoding the PFH and payload of the PHY frame. When receiving, this layer decodes and extracts the PFH and the payload of the received PHY frame. This encoding process has been divided into a number of steps represented by functional blocks shown in Figure 3.9. The total length of the physical frame before being encoded is $b_{PHY} = b_{PFH} + b_{payload}$ bits.

The PFH contains the necessary information to encode and modulate the PHY frame into OFDM symbols, such as the frame type, modulation and forward error correction parameters among others. Furthermore, the PFH consists of two parts: common part and variable part. The common part contains the Frame Type (FT), a 2 bit field, and the Header Check Sequence (HCS), which is a 12 bit Cyclic Redundancy Check (CRC) intended for PFH verification and computed using the generator polynomial:

Table 3.3: Valid values of payload FEC encoding parameters

Information Block, K (bytes)	Parity Check, R (bytes)
25	0
26-50	4
51-75	8
76-100	12
101-239	16

$G(x) = x^{12} + x^{11} + x^3 + x^2 + x + 1$. The variable part, called Frame-Type Specific Field (FTSF), depends on the type of PHY frame and the band plan used for CENELEC bands, which is 28 bits long. The total length of the PFH considered in this thesis is $b_{PFH} = 42$ bits.

Scrambler

The scrambler is used to randomize data and remove repeated patterns (such as long sequences of ones or zeros). G.hnem defines a Linear Feedback Shift Registers (LFSR), which creates a pseudo-randomized signal which enables better results for Forward Error Correction (FEC). Scrambling also eliminates the dependency of power spectrum of the transmitted signal upon the data and the signal's power is distributed over the frequency band which reduces the interference of adjacent subcarriers. The linear function of the LFSR is $x^7 + x^4 + 1$ and the initialization vector is 0x7F. The payload and header are scrambled separately.

Forward Error Correction

The Forward Error Correction (FEC) encoder consists of an inner convolutional encoder and an outer Reed Solomon encoder. The Reed-Solomon encoder is bypassed for the header and payloads that are shorter than 25 payload bytes. In those cases only the convolutional encoder is used. Reed-Solomon encoder is a cyclic error correcting code suitable as multiple-burst bit-error correcting code. G.hnem uses a standard byte-oriented Reed-Solomon code, Galois Field GF(256). Each information block c_0, c_1, \dots, c_m has K input bytes appended with R check bytes, so that $t = \frac{R}{2}$ erroneous bytes can be corrected. G.hnem offers different encoding information block size, i.e. different K values, and different values for parity check bytes, i.e. different R values, which enables to adapt to the medium characteristics. The number of RS parity-check bytes depends on the RS information block size chosen, and can vary from 0 to 16 bytes, as shown in Table 3.3.

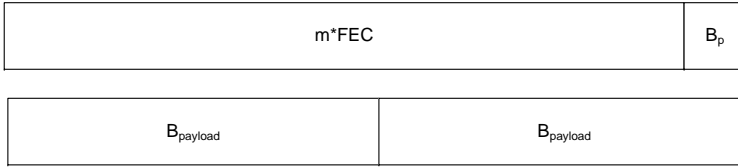

Figure 3.10: Fragmentation and Aggregation

The convolutional encoder is a type of error correcting code suitable as a random bit-error correcting code. G.hnem defines two code rates: $1/2$, for a convolutional encoder with constraint length 7 and generator polynomials $g_0 = 133_8$ and $g_1 = 171_8$, and $2/3$ obtained by puncturing the rate $1/2$ with the puncturing pattern $[1\ 1; 0\ 1]$. For the header, only the code rate $1/2$ is available. The payload and the header are convolutionally encoded separately and 6 bits are added at the end of the header and payload to flush the encoder. The number of bits in the physical frame after the convolutional encoder is $b_C = \frac{b_{header}+6}{rate_h} + \frac{m \cdot (K+R) \cdot 8+6}{rate_p}$ bits, where $rate_h = 1/2$ and $rate_p = 1/2$ or $2/3$, depending on the settings in the transmitter.

Fragmentation and Aggregation

The m output blocks of the FEC are concatenated and divided into fragments. The length of the fragments is different for the payload and the header. For the header, the fragments are always $B_{header} = \frac{b_{PFH}+6}{rate_{PFH}}$ bits, which for CENELEC is always 96 bits. On the other hand, in the case of the payload, the fragment length, $B_{payload}$, depends on the number of bits carried in each OFDM symbol and the number of symbols in a half of the AC cycle. If the total amount of bits after passing the FEC encoder is not a multiple of $B_{payload}$, B_{pad} padded bits are added to the last fragment, as shown in Figure 3.10. Therefore, the length of the payload after this block can be expressed as $b_{frag} = B_0 \cdot N_{frag} = \frac{c \cdot (K+R) \cdot 8+6}{rate_p} + B_p$, where N_{frag} is the total number of fragments.

Fragment Repetition Encoder

Each fragment of $B_{payload}$ bits is copied R_{Tp} times and all repetitions are concatenated to create a Fragment Buffer (FB). Each fragment repetition, excluding the original fragment, is cyclically shifted by $(d-1) \cdot M$ bits relative to the original fragment, where d is the repetition number and $M = \lceil (B_{payload}/R_{Tp}) \rceil$. In the normal mode of operation, R_{Tp} is 1, however in robust mode, where data repetitions are used, R_{Tp} can have the following other values: 2, 4, 6, and 12. The total number of bits in the payload after

this functional block is:

$$b_{rep} = B_{payload} \cdot N_{frag} \cdot R_{Tp} = \left[\frac{c \cdot (K+R) \cdot 8+6}{rate_p} + B_p \right] \cdot R_{Tp}$$

In the case of the header, the number of R_{Th} repetitions depends on the data bits carried by the OFDM symbol, the band plan used and the transmission mode: normal or robust. The total number of transmitted OFDM symbols for the PFH is NS_h . These NS_h OFDM symbols are divided into fragments of NS_i OFDM symbols. NS_i depends on the number of bits carried per OFDM symbol and the N_{ZC} , which is the total number of bits loaded on the symbols that span at least 10ms (for the case of 50 Hz AC lines). If NS_h is not a multiple of NS_i , the last fragment will be incomplete, i.e. the last fragment will have less than NS_i OFDM symbols. Each fragment of NS_i OFDM symbols shall be cyclically shifted relative to the previous copy before interleaving.

For the bandwidth studied in this paper, CENELEC A band, and considering all subcarriers are either active or pilot subcarriers, in normal mode R_{Th} is 10 and in robust mode the number of repetitions of the fragment is 20. Consequently, the header in normal mode is 15 OFDM symbols and in robust mode 30. For the case herein studied NS_i is 15 OFDM symbols. Therefore, in normal mode there is only one fragment and in robust mode there are two fragments. These fragments are the input blocks of the interleaver. Each fragment is $B_{header} \times R_T = \left[\frac{b_h+6}{rate_h} \right] \times R_T$ bits, which means that the header transmitted in normal mode is $\frac{b_{header}+6}{rate_h} \times 20 = 990$ bits and in robust mode $\frac{b_{header}+6}{rate_h} \times 40 = 1980$ bits.

*Interleaver*¹

Due to the frequency and time fading in narrowband power line channels, signals of the OFDM subcarriers can be received at different amplitudes. Some subcarriers can be less reliable than others, caused by fades in the spectrum. During some time periods, all or big parts of subcarriers can be erased due to fades in time (impulse noise). This can lead to burst errors instead of randomly scattered errors. Therefore the encoder includes an interleaver that randomizes the occurrence of these errors and burst errors are avoided.

The interleaver input is a vector of B_I bits, where $B_I = B_{payload}$ bits in the case of the payload and $B_I = NS_i \cdot k_h$ for the header, where k_h are

¹During the development of the MATLAB implementation of the interleaver, I found some inconsistencies and contacted Vladimir Oksman. They used the information I provided them to eliminate inaccuracies in the recommendation.

the number of bits carried per OFDM header frame. The input bits are inserted into the interleaver input matrix, which has m columns, where m is the number of active subcarriers, and $n = \frac{B_{payload}}{m}$ rows. Then those bits are permuted to create the interleaver output matrix.

After the permutation, the bits are extracted from the output interleaver matrix in the same order that they were written into the input interleaver matrix.

Physical Medium Dependent

The main functionality of this layer is, when transmitting, to add the preamble and Channel Estimation Symbols (CES) to the PHY frame, generate the bit sequence for the pilot subcarriers and modulate the PHY frame. When received, frames are demodulated, decoded and transferred to the PMA. The CES and preamble are processed and the results are passed to the PHY management entity. The recovered bits from the pilot and inactive subcarriers are also submitted to the PHY management and used for channel estimation.

This standard defines an OFDM modulation which can efficiently utilize the limited bandwidth and facilitates a robust communication. The A band is divided into orthogonal subcarriers and the number of bits carried by each subcarriers depends on the modulation scheme used. The OFDM signals to be transmitted are generated by performing inverse discrete Fourier transform on the complex valued allocated in each subcarrier.

The frequency band defined by G.hnem has the first subcarrier at frequency 35.9375 kHz and last subcarrier at 90,625 kHz. The spacing between subcarriers is 1,5625 kHz. Consequently, the number of subcarriers is 36. However, not all these subcarriers are used for data transmission and have been classified according to the information they carry:

- Masked subcarriers: do not carry any data and are not used for transmission.
- Supported subcarriers:
 - Active Subcarriers: carry the data from the physical frame.
 - Inactive Subcarriers: can be used for measurement or other auxiliary purposes.
 - Pilot Subcarriers: can be used for channel estimation, timing recovery or other auxiliary purposes. The number of pilot subcarriers in each OFDM symbol is defined in the G.9955 recommendation and depends on the number of active subcarriers.

Table 3.4: G.hnem Physical Layer Specification

	G.hnem CENELEC
Transport Layer	Ipv6, IPv4, Ethernet
Working Bandplans	35 -143 kHz
OFDM	
-IFFT size	128
-Sampling frequency	200 kHz
-Length cyclic prefix	20 or 32
-Windowing size	8 samples
-subcarrier spacing	1.5625 kHz
Forward Error Correction	Reed Solomon code (K=133, R=16) and Convolutional code (1/2)
Modulation	BPSK, QPSK, 16-QAM mapping for 3 bits is under study

The main parameters of the modulation for CENELEC band are summarized in Table 3.4.

Tone Mapper

The functional block Tone Mapper divides the incoming bits into groups of OFDM symbols and associates them to a specific subcarrier. Furthermore, the subcarriers are arranged into groups of G subcarriers, where G depends on the band plan. These subcarriers groups can be either active used for data transmission, or inactive. This is indicated in the PFH. The particular active subcarriers between two particular nodes may depend on channel characteristics, such as loop attenuation and noise. In this thesis, it has been considered that there are no masked subcarriers or inactive subcarriers. All the subcarriers are used for transmitting data or as pilots subcarriers for channel estimation.

The number of bits in each OFDM symbol may be different for the header and the payload; it is fixed for the header and is chosen for the payload according to the channel and noise characteristics. For the simulations in this thesis, it has been considered that all subcarriers are active in the A band.

Bit Generator

The bit generator generates a sequence of bits to be carried in inactive subcarriers and pilot subcarriers by using a Pseudo-Random Binary Sequence (PRBS) defined by the LFSR generator with the polynomial

$p(x) = x^7 + x^4 + 1$. The LFSR generator is initialized with a seed 0x7F at the beginning of the first payload OFDM symbol.

Preamble Generator

The preamble is used to detect the presence of a frame, to synchronize to the frame boundaries and to acquire the physical layer parameters. The preamble consists of two sections. The first section is composed of repetitions of S1 OFDM symbol. The bits for the S1 OFDM symbol are also generated using the same PRBS as before. The S2 OFDM symbol is the inverted time-domain waveform of S1 OFDM symbol.

CES Generator

The CES is composed by two OFDM frames. The bits are generated using the same PRBS as the one used for inactive and pilot subcarriers. The bits are loaded onto each subcarrier using a QPSK modulation. It can also be observed that the CES is transmitted between OFDM header symbols. The CES symbols are used to increase the robustness of frame detection in case of strong impulse noise.

Constellation Encoder

The possible modulation schemes that G.hnem defines are BPSK, QPSK, 3-bit constellation (still under study) and 16-QAM for the payload bits. For the header, bits are always modulated using QPSK scheme. The constellation encoder generates a complex value according to the particular set of bits modulated on each subcarrier, which represents a constellation point.

Inverse Discrete Fourier Transform

Inverse Discrete Fourier Transform (IDFT) generates the time domain samples from the complex numbers generated by the constellation encoder. For each OFDM symbol the conversion from frequency domain to time domain is performed following:

$$x_n = \sum_{i=0}^{N-1} e^{j \cdot 2 \cdot \pi \cdot i \cdot \frac{n}{N}} \cdot Z_n \quad \text{for } n = 0 \text{ to } N - 1$$

where i is the subcarrier index and N represents the maximum number of possible modulated subcarriers in the frequency spectrum, which for the case of CENELEC is 128. Due to the fact that only CENELEC A band is used, Z_i , which represent the complex value carried by i -th subcarrier, has non-zero values for subcarriers out of this band.

Cyclic Prefix Extension

The time-sample of the OFDM symbols are extended by prefixing N_{CP} samples to each OFDM symbol. This cyclic prefix is used to provide a guard interval between adjacent OFDM symbols to protect against inter-symbol

Table 3.5: Valid Cyclic Prefix Values

OFDM frame type	N_{CP}	Guard Interval (N_{GI})
Header and CES	8	0
Payload, BPSK & QPSK	20	12
Payload, 3-bit & 16QAM	32	24

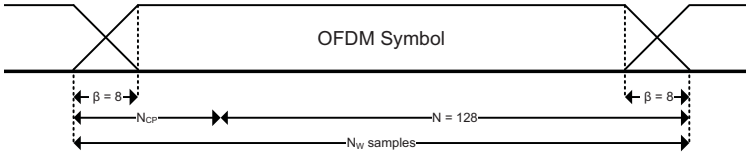
**Figure 3.11:** OFDM Symbol

interference. These samples are a copy of the last N_{CP} time-samples of the symbol:

$$CP_n = x_{n+N-N_{CP}} \quad \text{for } n = 0 \text{ to } N_{CP} - 1$$

The number of cyclic samples used varies from the header to the payload and also depends on the modulation scheme used. Table 3.5 shows the N_{CP} used for the payload, the header and the CES in CENELEC bands.

Windowing and Concatenation

After adding the cyclic prefix, each OFDM symbol is windowed and the first and last $\beta = 8$ samples are used to shape the envelope of the transmitted symbol. This provides sharp power spectral density roll-offs, which create deep spectral notches and reduction of out of band power spectral density. The guard interval N_{GI} is between OFDM symbols is $N_{CP} - \beta$. The standard does not provide a roll-off function as this should be vendor discretionary. The window used in the present simulation follows the following function:

$$w_n = \begin{cases} n/8 & 0 \leq n < \beta \\ 1 & \beta \leq n < N_S - \beta \\ (N_W - n)/8 & N_W - \beta \leq n < N_W \\ 0 & \text{otherwise} \end{cases}$$

where $N_W = N + N_{CP}$ is the total time samples per OFDM symbol. After windowing the last and first β , samples of adjacent OFDM symbols in the transmitted frame are overlapped and added as shown in Figure 3.11.

Interpolation and Frequency Up-Shift

The last functional block of the OFDM modulator interpolates the signal by a factor p , which is vendor discretionary. A linear interpolation has been

implemented in this thesis with an interpolation factor 2, which gives a sampling frequency of 200 kHz. This sampling frequency complies with the Nyquist theorem, where the sampling frequency has to be at least double the signal bandwidth. The frequency up-shift is performed and the real part of the signal is transmitted.

The final transmitted signal is:

$$Re(s_n) = Re(u_n) \cdot \cos \frac{2\pi mn}{Np} - Im(u_n) \cdot \sin \frac{2\pi mn}{Np}$$

where u_n is the interpolated signal, N are the number of subcarriers, $m \geq N/2$, p is the interpolation factor and n is the number of time sample of the transmitted signal.

3.6 MATLAB Models

A G.hnem transmitter and receiver have been modeled in MATLAB to analyse the performance of G.hnem in CENELEC A band for the communication between customers and utilities. The implemented MATLAB transmitter and receiver have been developed using the G.9956 and G.9955 recommendation explained in Section 3.5.2 and Section 3.5.3 respectively.

In order to compare the results of G.hnem, a G3-PLC transmitter and receiver have been also modelled in MATLAB. An overview of G3-PLC physical layer is provided in Section 3.7.1.

For the analysis of conventional communication systems, stationary additive white Gaussian noise (AWGN) is usually used as noise model. However, power line channels have a strong presence of time-varying non-white and often non-gaussian noise. Power line channel presents technical challenges due to the fact that it is a very harsh and noisy environment and therefore makes it difficult to model [97]. This channel is characteristic for its time varying, frequency selective, i.e. non white noise, coloured background noise and impulsive noise. The noise found in power lines cannot be represented by additive white Gaussian noise as other traditional communication channels. In [72], the noise found in power line channels is divided into 3 main types:

- Coloured Background Noise: can be also considered a Time-Invariant Continuous Noise, which has a constant envelope for at least more than a few AC voltage cycles.
- Impulsive noise: caused by the different rectifiers within DC power supplies and appliances, switching transistors, which can occur all

over the power grid. This noise is abrupt with large amplitudes and short durations. It can be further divided into synchronous and asynchronous impulsive noise. The most relevant impulsive noise for the CENELEC A band is the synchronous or cyclic impulsive noise. This noise is synchronous to AC mains composed by a train of impulses with the frequency of AC mains or double.

- Narrowband interference: cause by broadband radio stations and present in the frequency band [1-22] MHz. This noise can be dismissed, as it only affects the broadband power line communications (CENELEC A band frequency band as its frequency band is 3-95 kHz).

Despite the uniqueness of the power line noise, some models for power line noise exist. Most of the literature analyzes indoor power line noise, such as [116], [117] and [118]; and broadband noise models, such as [119], [120] and [121]. However, two noise models for narrowband power line channel have been chosen to analyse the performance of G.hnem. These two models are described in more detail in Section 3.6.1 and 3.6.2.

Furthermore, it is hard to define general transfer function as the power grid architecture varies from country to country. In addition, the transfer function of a power line channel varies when the topology changes, i.e. when devices are plugged in/out or switched on/off. Due to the lack of a general power grid topology and its particular characteristics, there is no commonly accepted simple model for power line channel. In order to model the power line channel, researchers have been modeling this channel using the two following approaches [98]:

- Deterministic models: These types of models have the advantage of not requiring measurements of the power line channel. However, they do require detailed knowledge of the link topology and of the cable models. This approach is based on generic signal propagation along any Transmission Line based channel, where the signal propagation is predominantly affected by multipath effects arising from the presence of several branches and impedance mismatches which cause multiple reflections. Examples of this type of models can be found in [7].
- Statical models: These types of models have the advantage of not requiring knowledge either of the link topology or of the cable models. However, they do require an extensive measurement to develop them. This approach is based on multiconduct or transmission line models combined with a set of topologies which represent the majority of

Table 3.6: Variance Parameters

l	A_l	θ_l [deg]	n_l
0	0,230	-	0
1	1,38	174,	1,91
2	7,17	145	157000

cases found in the power grid. Examples of this type of models can be found in [7].

A power line channel model based on measurements, presented in [122], and a statical model, presented in [7], have been chosen to analyse the performance of G.hnem. In the following subsections the noise and channel models used in this thesis are discussed in more detail.

3.6.1 PLC Noise by Katayama et al.

A mathematical model of noise in Narrowband Power Line Communication Systems is presented in [5], by Katayama et al.. This noise model expresses the time variant, cyclic impulsive and non-white features of noise in power line cables. The noise is expressed as the sum of cyclostationary Gaussian processes and the non-stationary components are represented with a number of parameters that have been obtained through measurements. The model proposed in [5] denotes the variance of the power line noise as:

$$\sigma^2(t, f) = \sigma^2(t)\alpha(f)$$

where:

$$\sigma^2(t) = \sum_{l=0}^2 A_l | \sin(\pi t/T_c + \theta_l) |^{n_l} \quad \alpha(f) = \frac{a}{2} e^{-a|f|}$$

where f is the frequency in Hz, $a = 1,2 \cdot 10^{-5}$, $T_c = \frac{T_{ac}}{2}$ (T_{ac} is the AC frequency, 50 Hz in Europe) and the rest of the variance parameters are summarized in Table 3.6. Figure 3.12(a) shows the computer simulated noise in half an AC cycle presented in [5]. This noise waveforms are very similar and follow the same pattern as the measure wave form shown in Figure 3.12(b). This pattern is repeated every half an AC cycle. Depending on the length of the frame, i.e. depending on how many AC cycles the frame is transmitting, the MATLAB script generates one or more power spectrums to be added to the transmitted signal.

Figure 3.13 shows the computer generated noise waveform used in the herein presented MATLAB implementation for an AC cycle by using the mathematical model.

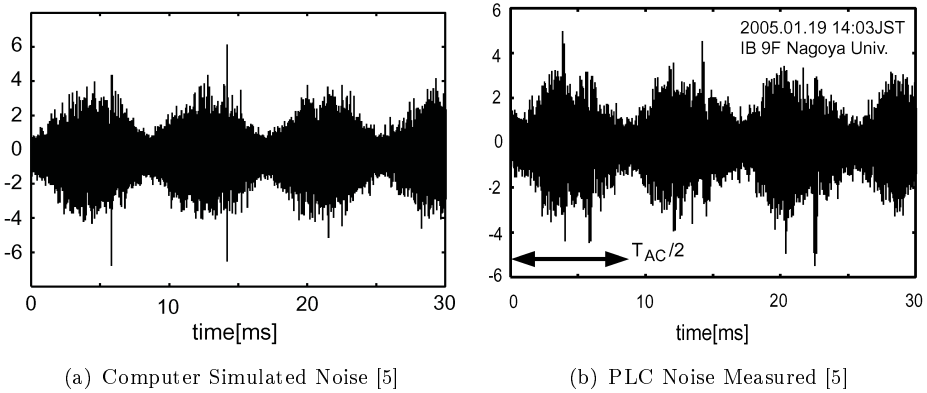

Figure 3.12: PLC Noise by Katayama et al.

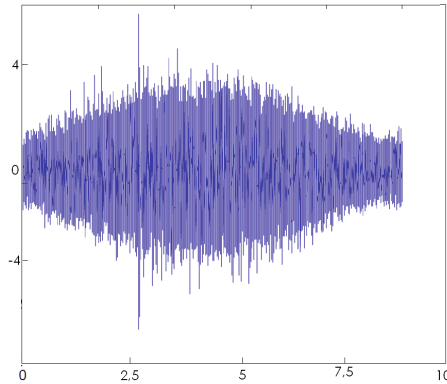

Figure 3.13: Computer Generated Noise

3.6.2 PLC Noise by Hooijen

The second noise model used in this thesis is presented in [123]. This noise model is used to express the coloured background noise found in Residential Power Circuits (RPC). This type of noise decreases as the frequency increases and its average spectral density is equal to:

$$N(f) = 10^{K-3,95 \cdot 10^{-5} \cdot f} [W/kHz]$$

where f is the frequency in Hz and K is a Gaussian-distributed with an average $\mu = -5.64$ and standard deviation $\sigma = 0,5$, which is obtained from measurements approximations. The value K is constant for long periods of time, including many seconds to hours. Therefore, it can be considered that K remains unchanged during the transmission of a G.hnem frame. For the simulations in this thesis, the worst case scenario has been chosen, $K = \mu + 2\sigma$:

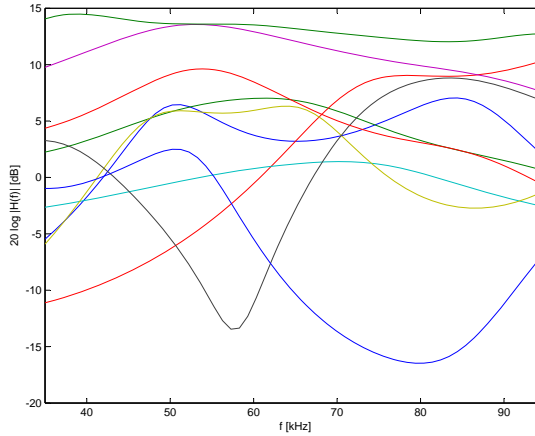

Figure 3.14: Sample Channel Transfer Functions $H(f)$

$$N_{worst}(f) = 10^{-7,64-3,95 \cdot 10^{-5} \cdot f} [W/kHz]$$

As it can be seen from this equation, the noise power is inversely proportional to the frequency. Therefore, this noise is more significant in narrowband PLC than in broadband PLC.

3.6.3 Statistical Time-Varying, and Frequency Selective Channel Model

The first channel model chosen is presented in [122]. This model is a statistical model for communication between smart meters and the transformers found in the distribution system of the power grid. It is designed to model the frequency selective and time varying loads aspects of the power line channel.

The examples of signal propagation of the i^{th} smart meter are shown in Figure 3.14. The model uses quasi-static approximation to calculate the transfer function of the channel, $H^i(f)$, from the i^{th} smart meter perspective:

$$H^i(f) = H^{i-1} \frac{z_{eq}^i(f)}{z_{eq}^i(f) \cosh(\gamma l) + z_0 \sinh(\gamma l)}$$

where $z_{eq}^i(f)$ is the equivalent impedance seen towards the leaves at the i^{th} meter. It can be seen that the transfer function $H^i(f)$ is provided recursively in terms of transfer function $H^{i-1}(f)$ to the $(i-1)^{th}$ meter.

The authors in [122] use Monte-Carlo simulations to estimate various parameters of interest (mean and correlations).

3.6.4 Multi-Path Propagation Channel Model

The reference channel model used in this article is defined within the OPERA project [7]. The transfer function proposed in [7] includes the effects of multi-path propagation due to various reflections in the power supply networks, as well as frequency and length dependence:

$$H(f) = \sum_{i=0}^{N-1} g_i e^{-\alpha(f)\ell_i} e^{-j\beta\ell_i}$$

where N is the number of effective echoes in the channel caused by the different branches found in the LV distribution grid, g_i is considered to be the product of the reflection and transmission coefficients of the path i , $\alpha(f)$ denotes the frequency dependent attenuation, ℓ_i stands for the cable length of the path i and β is the phase constant. This channel model was developed to provide a description on a statistical basis, therefore neither g_i nor ℓ_i directly correspond to a specific network topology. Furthermore, $\alpha(f)$ can be expressed as $\alpha(f) = a_0 + a_1 \cdot f$, where a_0, a_1 generally prove to be constant for a given type of cable. The phase constant is $\beta = 2\pi f/v_p$, where v_p is the phase velocity, $1,5 \times 10^8 m/s$. The authors of [7] provide nine reference channel models for three length classes to model the LV distribution grid channel. However, in this thesis only some of them has been used.

3.7 Comparison of G.hnem with G3-PLC and PRIME

In this section, the G.hnem recommendation is compared to G3-PLC and PRIME. G.hnem is actually based on these two technologies, however G.hnem is more similar to G3-PLC than to PRIME. G3-PLC was launched by Maxim in 2008 and PRIME was initiated by the PRIME alliance in 2007. There has been some trials of both technologies, which can be found in [124] and [125].

3.7.1 G3-PLC and PRIME overview

G3-PLC was launched by Maxim in 2008. G3-PLC defines a frequency band which starts at 35.9375 kHz and has the last subcarrier at 90,625 kHz with a subcarrier spacing of 1,5625 kHz, the same as G.hnem. The number of subcarriers per OFDM symbol is 36. The symbols are differentially encoded per subcarrier in time (t-DPSK), the modulation schemes that can be used

are DBPSK and DQPSK for the payload and DBPSK for the header. Figure 3.15(b) depicts the functional blocks of the PRIME transmitter.

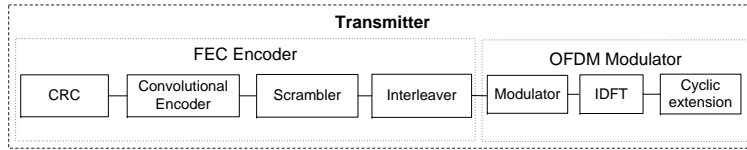

(a) PRIME

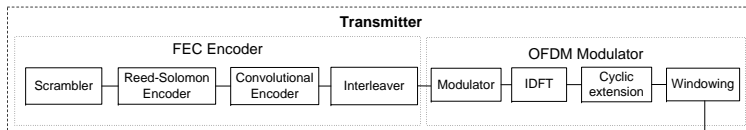

(b) G3-PLC

Figure 3.15: Transmitter Functional Blocks

PRIME was initiated by the PRIME alliance in 2007. PRIME defines a frequency band which starts at 41,992 kHz and ends at 88.867 kHz with a subcarrier spacing of 488.28125 Hz. Consequently, PRIME uses 97 subcarriers. Each subcarrier is modulated using DBPSK, DQPSK or D8PSK in frequency for the payload symbols and DBPSK for the header symbols. DBPSK, or differential BPSK, offers the advantage to demodulate the signal without knowing the absolute phase as it demodulates by detecting phase changes across adjacent symbols. Figure 3.15(a) depicts the functional blocks of the PRIME transmitter.

As G.hnem, G3-PLC and PRIME include a scrambler and a convolutional encoder to avoid the occurrence of long sequences of identical bits and to correct random occurring errors respectively. An interleaver is used in the three transmitters due to frequency fading, which is typical in power line channels. Together with convolutional encoding, interleaving randomizes the occurrence of bit errors prior to decoding, which improves error detection and correction. However, the interleaving algorithm is different for each technology. PRIME and G.hnem interleaver algorithm, although different between them, depend on the modulation used (number of bits carried per subcarrier). PRIME uses interleaving over each OFDM symbol, while G3-PLC and G.hnem use interleaving across symbols.

The three standards define an Orthogonal Frequency Division Multiplexing (OFDM) modulation, which can efficiently utilize the limited bandwidth and facilitate a robust communication. The A band is divided into orthogonal subcarriers and the number of bits carried by each subcarrier

Table 3.7: Technology Comparison [9]

	PRIME	G3-PLC	G.hnem
Frequency Range in CENELEC A band	42-89 kHz	36-91 kHz	36-91 kHz
Forward Error Correction	Convolutional Code	Reed Solomon code Convolutional Code Repetition code	Reed Solomon code Convolutional Code Repetition code
OFDM Modulator			
IFFT size	512	256	128
Subcarrier Spacing	488 Hz	1.5625 kHz	1.5625 kHz
Number subcarriers	97	36	36
Cyclic Prefix Length	30	48	20 or 32
Windowing	No	Yes	Yes
Modulation Scheme	DBPSK, DQPSK, D8PSK Frequency-differential	DBPSK, DQPSK Time-differential	BPSK, QPSK, 16QAM (3-bit under study)

depends on the modulation scheme used. The OFDM signals to be transmitted are generated by performing IFFT on the complex values allocated in each subcarrier. A cyclic prefix is added to each OFDM symbol for all three technologies. However, the number of cyclic samples varies between them as it can be seen in Table 3.7.

Further details regarding G3-PLC and PRIME can be found in [126] and in [127] respectively.

3.7.2 Simulation Description

In order to evaluate the performance of PRIME, G3-PLC and G.hnem, MATLAB simulations have been used. In this Ph.D., two transceivers have been implemented in MATLAB: one corresponding to a G.hnem transceiver and another corresponding to a G3-PLC transceiver. In Section 3.6 the performance of these technologies using these two models and the noise and channel models is analyzed.

The work of Martin Hoch in [6] has provided the authors with the results for PRIME and G3-PLC. As a PRIME transmitter has not been modeled in MATLAB, the results of this article have been used for the comparison. The results of G3-PLC provided by [6] have been used to validate the G3-PLC MATLAB model developed in this thesis. The same packet size, 133 bytes, noise and channel model have been used to obtain a fair comparison of the three technologies.

PRIME and G3-PLC use differential encoding. PRIME uses f-DPSK and a reference symbol is sent in every first subcarrier of each OFDM symbol, whereas G3-PLC uses and for t-DPSK and a reference symbol is sent at the beginning of every data packet in each subcarrier. Both systems have been proven to be likewise susceptible to sampling frequency errors [6]. It should be expected that G.hnem outperforms PRIME and G3-PLC, as it

Table 3.8: Overview of Simulation Parameters

	PRIME		G3-PLC		G.hnem	
	No CC	CC	No Rep	Rep	No Rep	Rep
DBPSK	P1	P2	G2	G1	-	-
BPSK	-	-	-	-	Gh2	Gh1
DQPSK	-	P3	G3	-	-	-
QPSK	-	-	-	-	Gh3	-

uses coherent modulation, which performs better than non-coherent, but requires a more complex receiver. In this thesis, it has been considered that the receiver includes carrier recovery algorithms using information carrier in the preamble and channel estimation symbols, so the receiver is synchronized and therefore no errors are produced by sampling frequency offset.

For each technology, different modulation and encoding parameters have been simulated. The parameters taken into consideration are: modulation scheme, convolutional encoding (only for PRIME) and repetition encoding (only for G3-PLC and G.hnem). Three different transmission modes have been considered and are defined in Table 3.8. 'No Rep' refers to the fact that the transmission has been done without the use of the repetitions. For G3-PLC, 'Rep' refers to using the repetition code, which repeats the data 4 times and for G.hnem, it refers to repeating 2 times fragments of the frame. 'CC' refers to Convolutional Code, which has been activated for all PRIME transmissions and is mandatory for G3-PLC and G.hnem. All convolutional codes have the rate to 1/2.

Two different separate scenarios have been simulated: (i) using only the noise model presented in [5] and described in 3.6.1, and (ii) using the channel noise presented in [122] with Additive White Gaussian Noise (AWGN). For each scenario and for each transmission configuration of G3-PLC and G.hnem, a 10000 simulations, i.e. 10000 frames, have been sent through the channel. As depicted on Figure 3.16.

In order to ensure a fair comparison, Martin Hoch, author of [6], was contacted and he provided the transfer functions used in his simulations. He generated a thousand transfer functions based on the model presented in [122] and introduced in Section 3.6.3. These transfer functions are then chosen randomly for every transmission and AWGN is also applied. AWGN has been used as a noise model, after Hoch used it in [6], in order to obtain a fair comparison between these three technologies. Conventional receivers are optimized for AWGN and have lower performance when impulsive noise is present.

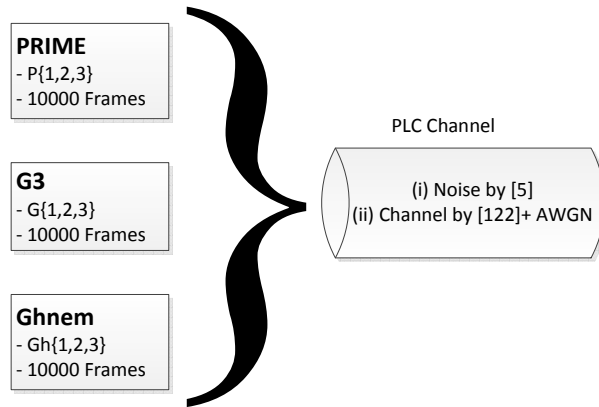

Figure 3.16: Simulation Scenarios

However, for these three technologies impulsive noise has been taken into consideration. Therefore a scrambler and an interleaver have been included in the transmitter to reduce the effects of this noise. It is expected that they perform worse under AWGN than power line noise.

3.7.3 Results and Discussion

The results for scenarios described in the previous section are shown in Figure 3.17, Figure 3.18 and Figure 3.19 in terms of Frame Error Rate (FER) vs Signal to Noise Ratio (SNR). The results obtained for G3-PLC have been compared to the ones presented by Hoch in [6]. As it can be seen from the figures, the results obtained are very similar, i.e. the FER for a specific SNR are similar. The little deviation between them is due to the random aspects of the code. For instance, even though the same transfer functions have been used for each frame, they have been randomly chosen for each transmission, therefore giving small variations in the results.

As it is expected for the same SNR, modulation schemes carrying more bits per subcarrier have higher FER: for G3-PLC, G1, which carries 1 bit/subcarrier, outperforms G2, which carries 2 bit/subcarrier. The same can be observed in PRIME and G.hnem results.

PRIME requires higher SNR to offer the same FER than G3-PLC and G.hnem. The main differences with those two technologies and PRIME are in the OFDM modulator. PRIME uses a slightly smaller bandplan from G3-PLC and G.hnem, 42-89 kHz for PRIME and 36-91 kHz for G3-PLC and G.hnem. In addition, PRIME has a smaller subcarrier spacing, 488 Hz compared to 1.5625 kHz. Therefore, PRIME has higher bit rate but

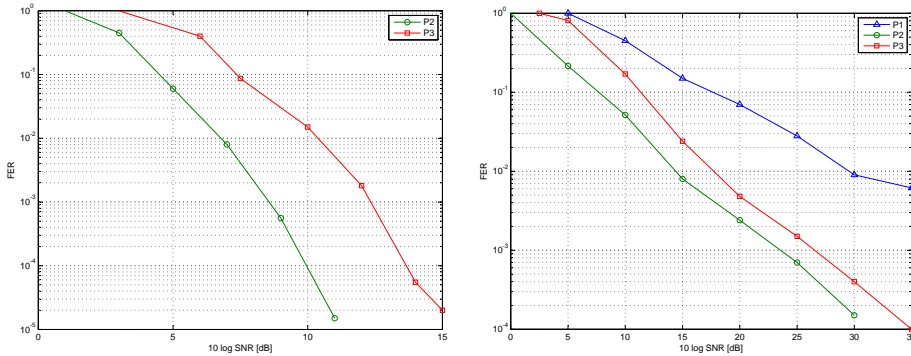

(a) PRIME results using the noise model presented in [5] (b) PRIME results using the channel model presented in [122] and AWGN

Figure 3.17: FER vs SNR for PRIME by Hoch in [6]

sacrifices its performance, i.e. for a SNR of 7 dB, a FER of $1 \cdot 10^{-1}$ was obtained for P2, $8 \cdot 10^{-3}$ for G3 and lower than $1 \cdot 10 - 4 \cdot 10^{-3}$ for Gh3.

The results for P1 with PLC noise were not provided in [6]. However, the importance of the convolutional code can be seen in the PLC channel results, where for an SNR of 20 dB P1 obtains a FER of $6 \cdot 10^{-2}$ and $2,5 \cdot 10^{-3}$ for P2.

For G3-PLC, a lower SNR is needed to obtain the same FER when the repetition code is used as more redundancy bits are added. The results using the noise model present a FER which is approximately $1.5 \cdot 10^{-3}$ for an SNR of 10 dB, when using the repetition code (G1), while an SNR of 16 dB is needed to obtain the same FER when the transmission is done without using the repetition code (G2).

For G.hnem, a lower FER is obtained for the same SNR when the repetition code is used. To obtain a FER $1 \cdot 10^{-3}$, SNR of 4 dB is needed for Gh1 (with repetition code) and an SNR of 12 dB for Gh2. In order to obtain lower FER for the same SNR, more repetitions should be used. G.hnem can repeat fragments of the frame up to 12 times if necessary.

Due to the fact that G3-PLC and G.hnem use more error correction bits, they include a Reed Solomon encoder apart from the convolutional encoder, while they perform considerably better than PRIME for power line noise and channel models. The FER obtained for an SNR of 10 dB for PRIME, G3-PLC and G.hnem is $2,5 \cdot 10^{-2}$, $2,5 \cdot 10^{-3}$ and $1 \cdot 10^{-4}$, respectively.

The best performance is offered by G.hnem. G.hnem outperforms G3-PLC due to encoding and OFDM modulator. The main differences between G3-PLC and G.hnem is the interleaver in the encoder and the modulation scheme in the modulator. As it can be seen in [128], BPSK slightly out-

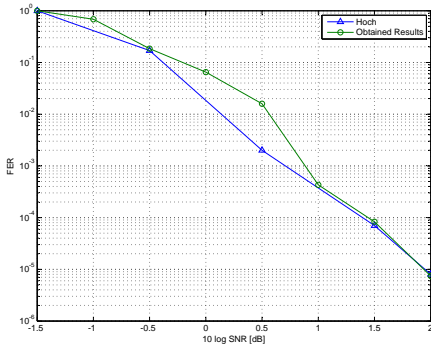

(a) G3-PLC with configuration G1 results using the noise model presented in [5]

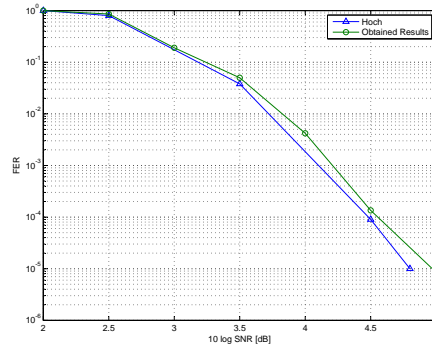

(b) G3-PLC with configuration G2 results using the noise model presented in [5]

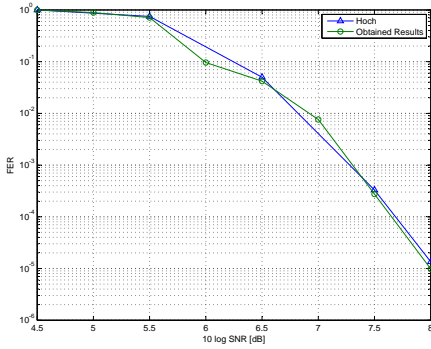

(c) G3-PLC with configuration G3 results using the noise model presented in [5]

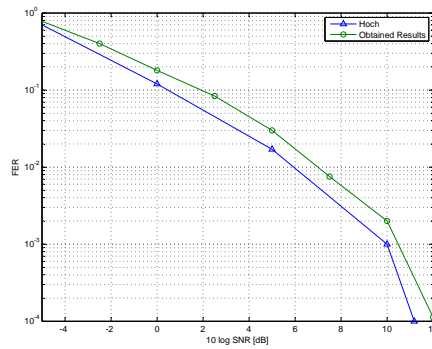

(d) G3-PLC with configuration G1 results using the channel model presented in [122]

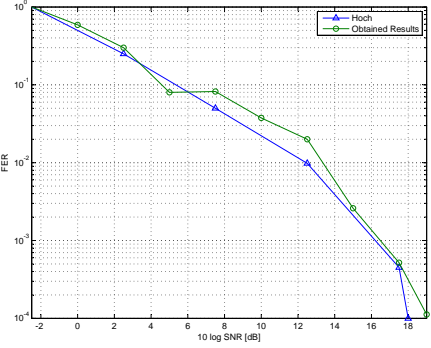

(e) G3-PLC with configuration G2 results using the channel model presented in [122]

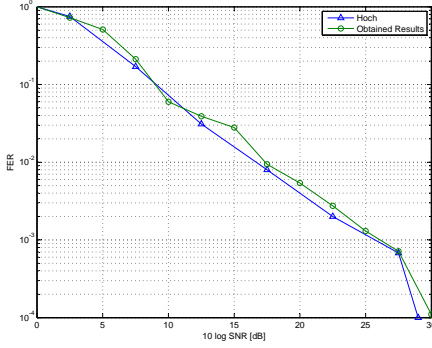

(f) G3-PLC with configuration G3 results using the channel model presented in [122]

Figure 3.18: FER vs SNR for G3-PLC by Hoch in [6] compared to the thesis results performs DBPSK and the G.hnem interleaver was developed from G3-PLC interleaver, so it was expected that G.hnem would outperform G3-PLC. However, it would be interesting to us the G3-PLC interleaver in a G.hnem encoder and compare the results. This would test which interleaving sche-

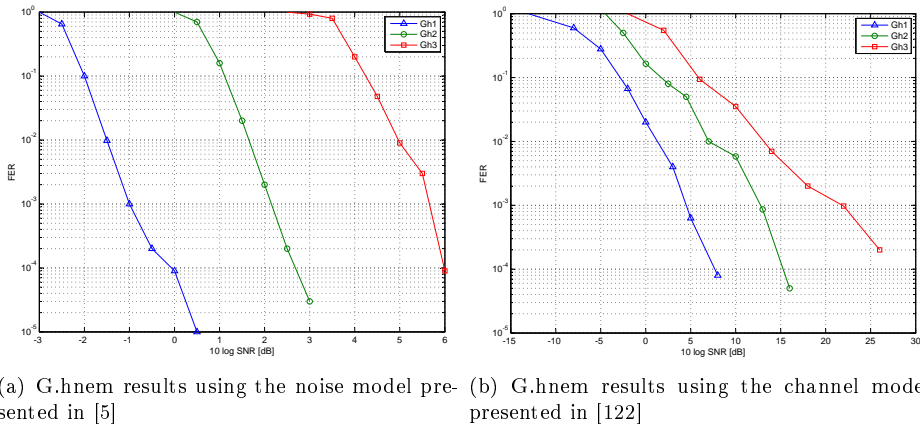

Figure 3.19: FER vs SNR for G.hnem

mes performs better under the PLC noise and channel.

It can also be observed that, for the three technologies, the effect of the channel is higher than the effect of the noise, requiring therefore a much higher SNR to obtain the same FER. This can be due to the fact that these simulations are using AWGN together with the channel and the receivers are not optimized for AWGN but for impulsive noise.

3.7.4 Conclusions and Further Work

G.hnem is based on G3-PLC and PRIME and as it was expected it outperforms them. The main differences between these technologies are found in the OFDM modulator and in the interleaver. Moreover, G3-PLC also outperforms PRIME, G3-PLC, as G.hnem has a higher subcarrier spacing in addition to using Reed Solomon encoding. G3-PLC sacrifices bit rate but increases robustness.

Further simulations using the models provided could be done. For instance, the performance of using a convolutional rate of $1/2$ vs $2/3$ could be compared. The effect of choosing different code word lengths for the Reed Solomon of G.hnem could also be studied.

However, it is considered that it would be more interesting to use the G3-PLC interleaver in the G.hnem transceiver.

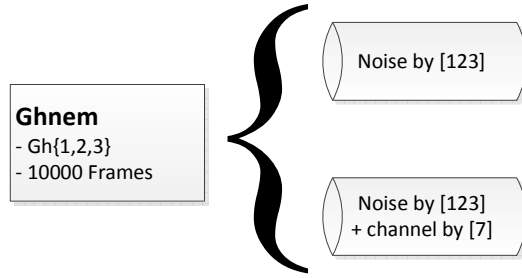

Figure 3.20: Simulation Scenarios for G.hnem

3.8 Analysis of G.hnem on the Low-Voltage Mains for AMI and DR

This section presents the resulted for the G.hnem recommendation using a model for PLC noise and channel of the Low-Voltage mains. The aim of this simulation is to evaluate G.hnem viability for AMI and DR.

3.8.1 Simulation Description

Two different scenarios have been considered for these simulations:

- (i) using only the noise model presented in [123]: to compare G.hnem performance against the noise presented in [5] and simulated in the previous section, and
- (ii) using the channel noise presented in [7] together with the PLC noise model from [123]: to evaluate the viability of G.hnem for AMI and DR.

These scenarios are depicted in Figure 3.20.

A packet size of 133 bytes has been used for G.hnem transmission of each transmission configuration, Gh{1,2,3}. For each scenario and for each transmission configuration a 10000 simulations, i.e. 10000 frames, have been sent through the channel.

In [7], nine different channel models for outdoor Low Voltage PLC systems are provided. For the simulations herein presented, the reference medium channel for the 250 meters with 14 branches has been used. This channel shows a pronounced low-pass characteristic, caused by the attenuation in the power lines. Additionally, it shows no distinct frequency-selective fading.

The transfer function is defined by the following equation:

Table 3.9: Path Parameters

i	l_i	g_i
1	211.5	0.0302
2	228	0.0445
3	243	-0.0178
4	254	-0.0213
5	278	0.0587
6	306	-0.0658
7	330	0.0320
8	360	-0.0356
9	390	0.0089
10	420	-0.0267
11	540	0.0267
12	740	-0.0267

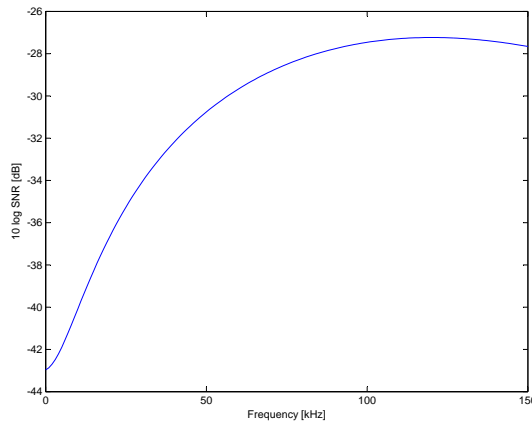
**Figure 3.21:** Transfer Function for LV mains by [7] [7]

$$H(f) = \sum_{i=0}^{N-1} g_i e^{-\alpha(f)l_i} e^{-j\beta l_i}$$

where $\alpha(f) = a_1 \cdot f = 4,5 \cdot 10^{-9} \cdot f$, $\beta = 2\pi f/v_p = \pi f/1,5 \times 10^8$, and the rest of the parameters are shown in Table 3.9.

This model has been chosen as it models the LV mains using the European power grid specifications. The channel model used in Section 3.7 was chosen as it also models the LV mains and allowed to compare the performance of G.hnem wit PRIME and G3-PLC. Additionally, the channel model used in this section is more restrictive since it has a higher attenuation, as it can be seen by comparing Figure 3.14 with Figure 3.21.

3.8.2 Results and Discussion

The results for scenarios described in the previous section are shown in Figure 3.22 in terms of Frame Error Rate (FER) vs Signal to Noise Ratio (SNR).

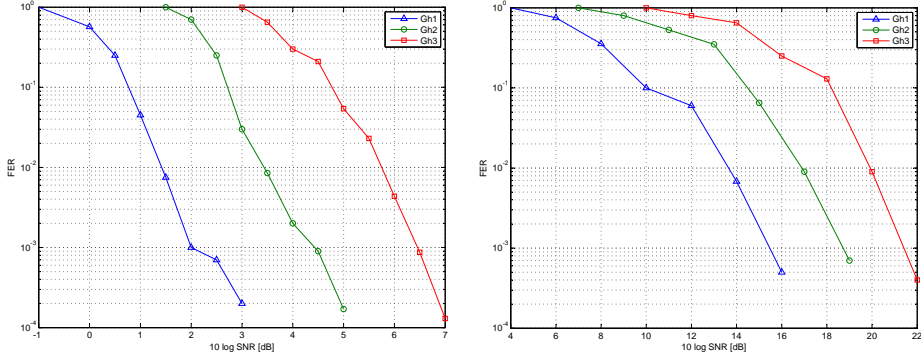

(a) G.hnem results using the noise model presented in [123] (b) G.hnem results using the channel and noise model presented in [7]and [123]

Figure 3.22: Simulation Results for G.hnem

The Power Spectral Density (PSD) of the noise models used in this section and on the previous section are plotted in Figure 3.23. It can be observed that the noise used in this section, Figure 3.23(b), has a higher PSD.

The maximum signal power has been determined using EN 50065 [10] standard. This standard defines the transmission maximum peak value allowed for communications over Low Voltage (LV) distribution power lines in the [3-148.5] kHz frequency range, which is 120dBμV or 0,02 W. Assuming the impedance in the transmitter is 50Ω, the maximum signal power is calculated as:

$$P_{signal} = P_{peak} \cdot DutyCycle = P_{peak} \cdot \frac{\Delta t}{T_{OFDM}}$$

where Δt is the sampling time and T_{OFDM} is the duration of an OFDM symbol. Therefore, the maximum possible SNR for the different transmission configurations is summarized in Table 3.10. This table also includes the expected FER for frames of 133 bytes.

In addition, the bit rate can also be calculated as:

$$bit_rate = \frac{b_{payload}}{T_frame}$$

where in this case $b_{payload}$ is 133 bytes and T_frame is the duration of the transmitted frame, which can be calculated as:

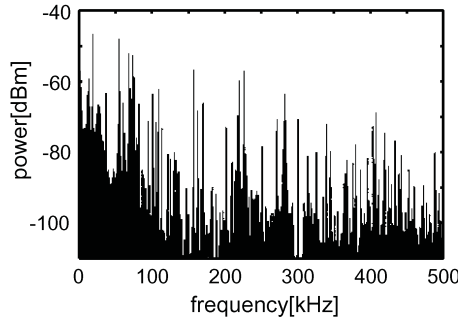

(a) Example of power spectrum density of power line noise presented in [5]

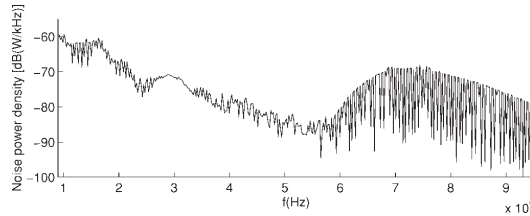

(b) Example of power spectrum density of power line noise presented in [123]

Figure 3.23: Power Spectrum Density of Power Line Noise

Table 3.10: SNR obtained following EN 50065 [10]

G.hnem	SNR	FER
Gh1	17	$< 1 \cdot 10_{-4}$
Gh2	17	$9.8 \cdot 10_{-4}$
Gh3	19	$1 \cdot 10_{-3}$

$$T_{frame} = num_frames \cdot T_{OFDMp} + headerduration(9, 6ms)$$

where T_{OFDMp} is the duration of a OFDM payload symbol, which can be calculated using the parameters in Section 3.5.3 as:

$$T_{OFDM} = \frac{N+N_{GI}}{N \cdot F_{SC}}$$

Table 3.11 shows the bit rate for these three transmission modes and also the expected FER in outdoor Low Voltage PLC systems of 250 meters with 14 branches.

Table 3.11: G.hnem bit rate and FER for 133B payload [10]

G.hnem	bitrate	FER
Gh0	4,66 kbps	$< 1 \cdot 10_{-4}$
Gh1	16,573 kbps	$9,8 \cdot 10_{-4}$
Gh2	27,191 kbps	$1 \cdot 10_{-3}$

3.8.3 Conclusions and Further Work

AMI and DR will require between 10-100 kbps. The bit rate obtained from the simulations above is sufficient for AMI and DR for configuration Gh1 and Gh2. In addition, the FER for these bit rates are considered to be acceptable as they are lower than 10^{-3} [129].

However, this bit rate can be increased by increasing the size of the packet. For instance, if the packet contains a payload of 500 Bytes and is transmitted using Gh2, the bit rate obtained would be approximately 33 kbps. The increase in bit rate is due to the overhead caused by the header.

To properly evaluate the latency, further simulations on G.hnem network DLL are needed. However, a rough estimate is calculated by considering that a transformer holds 25 houses [7] connected with 3 different phases, i.e. three channels, and that each needs to transmit through one of those channels:

$$Latency = \frac{25}{3} \cdot T_{payload}$$

The latency for BPSK without repetition code (G2), the latency obtained is 450 ms. The required latency for DR, which is more restrictive than AMI, can be as low as 500 ms. Therefore, it seems that G.hnem will fit all the requirements for AMI and DR, in terms of bit rate and latency.

3.9 Conclusions

This chapter has provided an overview of the Smart Grid. The different ongoing definitions and Smart Grid objectives and its functional have been discussed in Section 3.1. In addition, the communication requirements for AMI and DR have been presented and a network architecture for these two functionalities has been proposed. G.hnem has been chosen as the physical layer to link the customers and utilities as it offers certain advantages over other technologies, such as low deployment costs, security, scalability, high coverage and utilities ownership. To evaluate the performance of G.hnem

for the proposed architecture, a MATLAB model of the G.hnem transceiver has been developed. Additionally, a G3-PLC transceiver has also been implemented for two reasons: (i) to validate the model by comparing the results to [6] results, and (ii) to compare it to G.hnem. The last section of this chapter has focused on studying the performance under a power line channel and noise model for the low voltage power grid network.

Not all the objectives set for this second part of the Ph.D. were achieved. This is due to the fact that the Smart Grid communications involve different functionalities with different requirements and due to time limits not all of them could be studied in detail. Therefore, this thesis has focused only on AMI and DR access network, i.e. the network interconnecting the customers and the utilities.

The objectives set for this section were:

- Research the Smart Grid concepts and its objectives: the results of this research have been provided from Section 3.2 to Section 3.3.
- Study the possible communication technologies that could be used for Smart Grid communication: only the communication technologies for AMI and DR in the access network have been studied.
- Propose a network architecture for Smart Grid: as the Smart Grid has different functionalities a single communication network that would suit them all is unrealistic. The Smart Grid communication will be composed for a mesh of different networks, utilizing different communication technologies. As the focus has been on AMI and DR access network, a communication network for those functionalities has been proposed.
- Study the viability of the network proposed: the focus on the viability of the network proposed has been in the physical layer, where narrowband PLC has been chosen. Further work on the upper layers, such as the network layer and application layer should be done to complete the study of the viability of the network. However, it has been considered that the limiting factor of the architecture proposed was the physical layer due to the fact that power line cables provide a harsh channel which make communication difficult.

In addition, it was decided to study the viability of G.hnem as it is a very recent recommendation and there is almost no research done in this domain. It was considered that studying the performance of G.hnem on Low Voltage power grid networks would serve as base ground for other researchers.

Chapter 4

Conclusions and Outlook

There is considerable research being done on Home Energy Management and Smart Grid. This is due to the fact that the European Commission Climate Action set three energy targets to be met by 2020, known as the “20-20-20”. In order to meet these targets, most domains related with energy consumption have to be upgraded and improved. Home environment has been one of the areas of consumption growth and it is estimated that it will keep increasing, especially if electrical vehicles become commercialized. Therefore, there is an imminent need not only to reduce but also manage the power consumption in home environments.

Smart Grids represent more than upgrade on the power grid and its components. New functionalities will be provided to have a more efficient, resilient and robust power grid. Additionally, the power grid will suffer a considerable “restructuring”, as the traditional unidirectional flow of electricity (from power plants to consumers) will be replaced for a more distributed power grid, where alternative energies will have a more important role. However, in order to achieve all the Smart Grid objectives, Information and Communication Technologies are required.

This thesis has tried to participate in both research domains: home environments and ICT for Smart Grid functionalities. Firstly, a Home Energy Management System has been developed to help reduce the electricity consumption in residential environments. The main element of the HEMS is the Home Gateway which, besides offering monitoring and control of the home devices, it offers energy management strategies based on rules. As additional functionalities, it provides remote access and web services to interconnect to the Energy Rule Server from where users can update their energy management rules. Moreover, bridge components can be included

into the HEMS and communicate via web services with the home gateway. In the HEMS developed, it has also been considered that the smart meter will communicate with home gateway to provide billing information and Demand Response requests. Additionally, a scheduling algorithm has been implemented in the home gateway to limit the power consumption in order to reduce demand peaks.

Secondly, The Smart Grid concept and its functionalities have been researched. The objectives of the Smart grid and the ICT requirements have also been analyzed.

Thirdly, a communication network for AMI and DR has been proposed. G.hnem has been chosen as the power line technology used for the physical layer of this network. The performance of the G.hnem under different power line noise and channel models has been analysed. Considering the results obtained and the AMI and DR requirements, G.hnem is a viable communication technology for AMI and DR in the Smart Grid. Additionally, using power line communication has certain advantages over other technologies, such as high coverage, scalability, security and low deployment costs among others.

Even though the research in this thesis has met the majority of the objectives set at the beginning of the Ph.D., there is further work that can be done. The HEMS could be improved by further developing the HEMSOnt to incorporate for Advanced Metering Infrastructure concepts and Demand Response requests. The Demand Response request could be directly handled by rules, minimizing user interaction and achieving an automatic system. However, it is important to keep in mind the users' preferences and their comfort, as this could directly affect the users on how they use the HEMS. The same consideration has to be taken into account when developing more rules to reduce the power consumption.

The proposed AMI and DR network should be further researched to ensure that it meets the latency requirements of these two functionalities. The architecture proposed could maybe also be taken into consideration to be used for monitoring other components that can be found in the Low Voltage power grid network, such as status of the transformers and power cables.

Bibliography

- [1] “European Commission Energy,” April 2013. [Online]. Available: http://ec.europa.eu/energy/efficiency/labelling/labelling_en.htm
- [2] The Brattle Group, S. Freeman, and Co Global Energy Partners, LLC, “A National Assessment of Demand Response Potential, Staff Report,” Federal Energy Regulatory Commission, Tech. Rep., 2009.
- [3] N. I. of Standards and Technology, “NIST framework and roadmap for smart grid interoperability standards, release 1.0,” National Institute of Standards and Technology, Tech. Rep., 2010.
- [4] European Commission, *European Technology Platform SmartGrids - Vision and Strategy for Europe’s Electricity Networks of the Future*. Office for Official Publications of the European Communities, 2006.
- [5] M. Katayama, T. Yamazato, and H. Okada, “A mathematical model of noise in narrowband power line communication systems,” *Selected Areas in Communications, IEEE Journal on*, vol. 24, no. 7, pp. 1267 – 1276, July 2006.
- [6] M. Hoch, “Comparison of plc g3 and prime,” in *Power Line Communications and Its Applications (ISPLC), 2011 IEEE International Symposium on*, April 2011, pp. 165 –169.
- [7] H. C. Ferreira, L. Lampe, J. Newbury, and T. G. Swart, *Power Line Communications: Theory and Applications for Narrowband and Broadband Communications over Power Lines*. John Wiley and Sons, Ltd, Publication, 2010.
- [8] “Communications Requirements of the Smart Grid Technologies,” Department of Energy, Tech. Rep., 2010.

- [9] V. Oksman, “New ITU-T Recommendations for Smart Grid in-home and access communications.” Presented at ETSI Smart Grid Workshops Sophia Antipolis, France, 2011.
- [10] CENELEC, “Signaling on low-voltage electrical installations in the frequency range 3kHz to 148.5kHz Tech. Rep. EN 50 065-1,,” 1991.
- [11] BeyWatch Consortium, “D2.1:Service Requirement Specification,” 2009.
- [12] “The EU climate and energy package,” European Commission Climate Action, April 2013. [Online]. Available: http://ec.europa.eu/clima/policies/package/index_en.htm
- [13] European Technology Platform SmartGrids for the Electricity networks of the Future, “What is a Smart Grid? Definition,” April 2013. [Online]. Available: {<http://www.smartgrids.eu?q=node/163>}
- [14] S. Tomic, A. Fensel, and T. Pellegrini, “Sesame demonstrator: ontologies, services and policies for energy efficiency,” in *Proceedings of the 6th International Conference on Semantic Systems*, ser. I-SEMANTICS '10. New York, NY, USA: ACM, 2010, pp. 24:1–24:4. [Online]. Available: <http://doi.acm.org/10.1145/1839707.1839738>
- [15] A. Rossello-Busquet, “Ph.d. description and objectives,” 2010.
- [16] “Home Energy Management (HEM) STC,” Fraunhofer, Tech. Rep., 2009, accessed: April 2013. [Online]. Available: http://apps1.eere.energy.gov/buildings/publications/pdfs/building_america/rpm2011_3_hem.pdf
- [17] V. Sundramoorthy, G. Cooper, N. Linge, and Q. Liu, “Domesticating energy-monitoring systems: Challenges and design concerns,” *Pervasive Computing, IEEE*, vol. 10, no. 1, pp. 20–27, jan.-march 2011.
- [18] L. T. McCalley, C. J. H. Midden, and K. Haagdorens, “Computing systems for household energy conservation: Consumer response and social ecological considerations,” in *in Proceedings of CHI 2005 Workshop on Social Implications of Ubiquitous Computing*, 2005.
- [19] R. Kistler, S. Knauth, D. Kaslin, and A. Klapproth, “CARUSO - Towards a context-sensitive architecture for unified supervision and control,” in *Emerging Technologies and Factory Automation, 2007. ETFA. IEEE Conference on*, 25-28 2007, pp. 1445–1448.

- [20] S. Grilli, A. Villa, and C. Kavadias, “Comanche: An architecture for software configuration management in the home environment,” in *NBiS '08: Proceedings of the 2nd international conference on Network-Based Information Systems*. Springer-Verlag, 2008, pp. 283–292.
- [21] J. Zhang, A. Rosselló-Busquet, J. Soler, M. S. Berger, and L. Dittmann, “Home Environment Service Knowledge Management System,” in *The 11th International Conference on Telecommunications (ConTEL)*, 2011.
- [22] A. K. Dey and G. D. A. Daniel Salber, “A context-based infrastructure for smart environments,” Georgia Institute of Technology, Tech. Rep., 1999. [Online]. Available: <http://hdl.handle.net/1853/3406>
- [23] N. Shah, C.-F. Tsai, and K.-M. Chao, “Monitoring appliances sensor data in home environment: Issues and challenges,” in *Commerce and Enterprise Computing, 2009. CEC '09. IEEE Conference on*, 20-23 2009, pp. 439–444.
- [24] M. Shehata, A. Eberlein, and A. Fapojuwo, “IRIS-TS: Detecting Interactions between Requirements in DOORS.” *INFOCOMP Journal of Computer Science*, pp. 34–43, 2006.
- [25] M. Shehata, A. Eberlein, and A. Fapojuwo, “Managing Policy Interactions in KNX-Based Smart Homes,” in *Computer Software and Applications Conference, 2007. COMPSAC 2007. 31st Annual International*, vol. 2, 2007, pp. 367–378.
- [26] H. Si, S. Saruwatari, M. Minami, and H. Morikawa, “A Ubiquitous Power Management System to Balance Energy Saving and Response Time based on Device-level Usage Prediction,” *IPSSJ Journal*, vol. 18, pp. 147–163, 2010.
- [27] S. K. Das and D. J. Cook, “Designing smart environments: A paradigm based on learning and prediction,” in *International Conference on Pattern Recognition and Machine Intelligence (PReMI)*, 2005.
- [28] OSGi Alliance, “OSGi Service Platform Core Specification Release 4,” Accessed Dec. 2010. [Online]. Available: <http://www.osgi.org>

- [29] W3C OWL Working Group, "OWL 2 Web Ontology Language Document Overview," Accessed April 2012. [Online]. Available: <http://www.w3.org/TR/owl2-overview/>
- [30] D. Bonino, E. Castellina, and F. Corno, "The DOG gateway: enabling ontology-based intelligent domotic environments," *Consumer Electronics, IEEE Transactions on*, november 2008.
- [31] D. Bonino and F. Corno, "DogOnt - Ontology Modeling for Intelligent Domotic Environments," *The Semantic Web - ISWC 2008*, 2008.
- [32] S. Ok and H. Park, "Implementation of initial provisioning function for home gateway based on open service gateway initiative platform," in *Advanced Communication Technology, 2006. ICACT 2006. The 8th International Conference*, feb. 2006.
- [33] P. Valiente-Rocha and A. Lozano-Tello, "Ontology and swrl-based learning model for home automation controlling," in *Ambient Intelligence and Future Trends-International Symposium on Ambient Intelligence (ISAmI)*, ser. Advances in Soft Computing. Springer Berlin / Heidelberg, 2010.
- [34] S. H. Ju, Y. H. Lim, M. S. Choi, J.-M. Baek, and S.-Y. Lee, "An efficient home energy management system based on automatic meter reading," in *Power Line Communications and Its Applications (IS-PLC), 2011 IEEE International Symposium on*, april 2011.
- [35] J. Han, C.-S. Choi, and I. Lee, "More efficient home energy management system based on zigbee communication and infrared remote controls," *Consumer Electronics, IEEE Transactions on*, february 2011.
- [36] "Model BX2340, Specifications." [Online]. Available: http://www.samsung.com/uk/consumer/pcperipherals/monitors/professional/LS23CBUMBV/EN/index.idx?pagetype=prd_detail&tab=specification
- [37] FFG COIN funding line, "SESAME-S: SEmantic SmArt MEtering \tilde{U} Services for Energy Efficient Houses," April 2013. [Online]. Available: <http://sesame-s.ftw.at/>
- [38] A. Fensel, S. Tomic, V. Kumar, M. Stefanovic, S. V. Aleshin, and D. O. Novikov, "Sesame-s: Semantic smart home system for energy

- efficiency,” *Informatik-Spektrum*, vol. 36, pp. 46–57, 2013. [Online]. Available: <http://dx.doi.org/10.1007/s00287-012-0665-9>
- [39] J. McAffer, P. VanderLei, and S. Archer, *OSGi and Equinox: Creating Highly Modular Java Systems*, 1st ed. Addison-Wesley Professional, 2010.
- [40] A. S. Foundation, “Eclipse sdk version: 3.5.2,” 2010.
- [41] T. G. L. Liu and M. T. Özsu (Eds.), *Entry in the Encyclopedia of Database Systems*. Springer-Verlag, 2008.
- [42] W3C Working Group, “World Wide Web Consortium ,” Accessed April 2012. [Online]. Available: <http://www.w3.org/>
- [43] —, “RDF/XML Syntax Specification,” 2004, Accessed April 2012. [Online]. Available: <http://www.w3.org/TR/REC-rdf-syntax/>
- [44] Stanford Center for Biomedical Informatics Research, “Protégé Editor v3.4.4,” Accessed April 2012. [Online]. Available: <http://protege.cim3.net/download/old-releases/Proteges203.x/3.4.4/>
- [45] H. Knublauch, “Protege-OWL API Programmer’s Guide,” Accessed Dec. 2010. [Online]. Available: http://protegewiki.stanford.edu/wiki/ProtegeOWL_API_Programmers_Guide
- [46] M. J. O’Connor, “SQWRL,” Accessed April 2012. [Online]. Available: <http://protege.cim3.net/cgi-bin/wiki.pl?SQWRL>
- [47] I. Horrocks, P. F. Patel-Schneider, H. Boley, S. Tabet, B. Groszof, and M. Dean, “Swrl: A semantic web rule language combining owl and ruleml,” Accessed Dec. 2010. [Online]. Available: <http://www.daml.org/2004/04/swrl/>
- [48] Sandia National Laboratories, “Jess Rule Engine,” Accessed Dec. 2010. [Online]. Available: <http://www.jessrules.com/>
- [49] “Web Services Glossary W3C Working Group,” Accessed April 2011. [Online]. Available: <http://www.w3.org/TR/ws-gloss/>
- [50] “Apache CXF Distributed OSGi,” Accessed April 2011. [Online]. Available: <http://www.w3.org/TR/ws-gloss/>
- [51] Rosselló-Busquet, “Home Gateway for HEMS User Guide,” DTU Fotonik, Tech. Rep., 2013.

- [52] —, “Home Gateway for HEMS Developers Manual,” DTU Fotonik, Tech. Rep., 2013.
- [53] The e-Lite Research Group, “Dogont v1.0.4,” Accessed April 2012. [Online]. Available: <http://elite.polito.it/files/releases/dog/dogont/DogOnt-1.0.4-ZigBee/DOGOnt-1.0.4.owl>
- [54] M. J. O’Connor, “SWRLLanguageFAQ,” Accessed Dec. 2010. [Online]. Available: <http://protege.cim3.net/cgi-bin/wiki.pl?SWRLLanguageFAQ>
- [55] —, “SWRLBuiltInBridge,” Accessed Dec. 2010. [Online]. Available: <http://protege.cim3.net/cgi-bin/wiki.pl?SWRLBuiltInBridge>
- [56] “The Smart Grid: An Introduction,” U.S Department of Energy (DOE), Tech. Rep., 2008.
- [57] I. Richardson, M. Thomson, D. Infield, and C. Clifford, “Domestic electricity use: A high-resolution energy demand model,” *Energy and Buildings*, vol. 42, no. 10, pp. 1878 – 1887, 2010. [Online]. Available: <http://www.sciencedirect.com/science/article/pii/S0378778810001854>
- [58] I. Richardson and M. Thomson, “Integrated domestic electricity demand and PV micro-generation model,” April 2013. [Online]. Available: <https://dspace.lboro.ac.uk/2134/7773>
- [59] S. Firth, K. Lomas, A. Wright, and R. Wall, “Identifying trends in the use of domestic appliances from household electricity consumption measurements,” *Energy and Buildings*, vol. 40, no. 5, pp. 926 – 936, 2008. [Online]. Available: <http://www.sciencedirect.com/science/article/pii/S0378778807002022>
- [60] I. Richardson, M. Thomson, D. Infield, and A. Delahunty, “Domestic lighting: A high-resolution energy demand model,” *Energy and Buildings*, vol. 41, no. 7, pp. 781 – 789, 2009. [Online]. Available: <http://www.sciencedirect.com/science/article/pii/S0378778809000449>
- [61] Daintree Networks, “The value of wireless lighting control,” in *White Paper*, July 2010.
- [62] D. Tejani, A. Al-Kuwari, and V. Potdar, “Energy conservation in a smart home,” in *Digital Ecosystems and Technologies Conference*

- (*DEST*), *2011 Proceedings of the 5th IEEE International Conference on*, 2011, pp. 241–246.
- [63] “Residential Energy Consumption Survey Data,” U.S. Energy Information Administration, Independent Statistics and Analysis, Tech. Rep., 2008.
- [64] “Model 32LE4900, Specifications, ECO,” Accessed: 25/05/2012. [Online]. Available: <http://www.lg.com/uk/tv-audio-video/televisions/LG-led-tv-42LE4900.jsp>
- [65] “Model DVX550, Specifications, POWER,” Accessed: 25/05/2012. [Online]. Available: <http://www.lg.com/uk/tv-audio-video/video/LG-dvd-player-DVX550.jsp>
- [66] “Model S-HS111US, Specifications,” Accessed: 25/05/2012. [Online]. Available: <http://www.pioneerelectronics.com/PUSA/Home/Home-Theater-Systems/S-HS111US>
- [67] “Model: Pavilion Slimline s5670t series, Specifications,” Accessed: 20/03/2012. [Online]. Available: http://www.shopping.hp.com/webapp/shopping/store_access.do?template_type=series_detail&category=desktops&series_name=s5670t_series&jumpid=in_R329_prodexp/hhoslp/psg/desktops/promo_tile/3/dt_promo_tile3_s5670t_113
- [68] “Model WM12S32XEE, Ficha tecnica,” Accessed: 25/05/2012. [Online]. Available: <http://www.siemens-home.es/WM12S32XEE.html>
- [69] “Model WTW8658XEE, Ficha tecnica,” Accessed: 25/05/2012. [Online]. Available: <http://www.bosch-home.es/WTW8658XEE.html>
- [70] “Model SMS69T25EU, Ficha tecnica,” Accessed: 25/05/2012. [Online]. Available: <http://www.bosch-home.es/SMS69T25EU.html>
- [71] O. Hooijen, “On the channel capacity of the residential power circuit used as a digital communications medium,” *Communications Letters, IEEE*, vol. 2, no. 10, pp. 267–268, 1998.
- [72] M. Gotz, M. Rapp, and K. Dostert, “Power line channel characteristics and their effect on communication system design,” *Communications Magazine, IEEE*, vol. 42, no. 4, pp. 78–86, 2004.

- [73] V. Iversen, *Teletraffic Theory and Network Planning*. Technical University of Denmark, 2010, Accessed: 25/05/2012. [Online]. Available: <http://oldwww.com.dtu.dk/teletraffic/handbook/telenook.pdf>
- [74] —, “Reversible Fair Scheduling: the teletraffic revisited,” *20th International Teletraffic Congress*, 2007.
- [75] E. Iliakis and G. Kardaras, *Resource Allocation in Next Generation Internet: Provisioning QoS for Future Networks based on Teletraffic Theory*. VDM Verlag, 2010.
- [76] —, *Resource allocation in next generation internet*, 1st ed. VDM Verlag Dr. Müller Aktiengesellschaft & Co., 2010.
- [77] G. Kardaras, A. Rossello-Busquet, V. Iversen, J. Soler, and L. Dittmann, “Regulating electricity demand peaks for home appliances using reversible fair scheduling,” in *Internet Multimedia Services Architecture and Application(IMSAA), 2010 IEEE 4th International Conference on*, dec. 2010, pp. 1 –6.
- [78] National Academy of Engineering, “Greatest Engineering Achievements of the 20th Century,” accessed: 24/05/2013. [Online]. Available: <http://www.greatachievements.org/>
- [79] G. W. Arnold, “Laying the Foundation for the Electric Grids Next 100 Years,” 2011.
- [80] K. Barnes and B. Johnson, “Introduction To SCADA Protection And Vulnerabilities,” Idaho National Engineering and Environmental Laboratory, Tech. Rep. INEEL/EXT-04-01710, Tech. Rep., 2004.
- [81] “What is a Smart Grid? Definition,” April 2013. [Online]. Available: <http://www.smartgrids.eu?q=node/163>
- [82] S. Jiménez, “Smart Grid Mandate, Standardization Mandate to European Standardisation Organisations (ESOs) to support European Smart Grid deployment,” European Commission Directorate-General for Energy, Tech. Rep. Ref. Ares(2011)233514, 2011.
- [83] “Report to NIST on the Smart Grid Interoperability Standards Roadmap,” Electric Power Research Institut, Tech. Rep., 2009.
- [84] Department of Energy, “The smart grid an introduction,” U.S. Department of Energy, 2008.

- [85] “Activity Report 2009,” Union of the Electricity Industry - EUR-ELECTRIC, Tech. Rep., 2009.
- [86] S. Jiménez, “Smart Grids: from innovation to deployment,” Communication from the Commission to the European Parliament, the council, the European Economic and Social Committee of the Regions, Tech. Rep., Tech. Rep., 2011.
- [87] A. Rossello Busquet, G. Kardaras, V. Iversen, J. Soler, and L. Dittmann, *Reducing Electricity Demand Peaks by Scheduling Home Appliances Usage*, 2011, pp. 156–163.
- [88] A. Iwayemi, P. Yi, X. Dong, and C. Zhou, “Knowing when to act: an optimal stopping method for smart grid demand response,” *Network, IEEE*, 2011.
- [89] S. Mohagheghi, J. Stoupis, Z. Wang, Z. Li, and H. Kazemzadeh, “Demand Response Architecture: Integration into the Distribution Management System,” in *First IEEE International Conference on Smart Grid Communications*, 2010.
- [90] V. Gungor and G. Hancke, “Industrial wireless sensor networks: Challenges, design principles, and technical approaches,” *Industrial Electronics, IEEE Transactions on*, vol. 56, no. 10, pp. 4258–4265, 2009.
- [91] Q. Yang, J. Barria, and T. Green, “Communication infrastructures for distributed control of power distribution networks,” *Industrial Informatics, IEEE Transactions on*, vol. 7, no. 2, pp. 316–327, 2011.
- [92] H. Li and W. Zhang, “Qos routing in smart grid,” in *Global Telecommunications Conference (GLOBECOM 2010), 2010 IEEE*, 2010, pp. 1–6.
- [93] X. Fang, S. Misra, G. Xue, and D. Yang, “Smart grid: The new and improved power grid: A survey,” *Communications Surveys Tutorials, IEEE*, vol. 14, pp. 944–980, 2012.
- [94] P. Parikh, M. Kanabar, and T. Sidhu, “Opportunities and challenges of wireless communication technologies for smart grid applications,” in *Power and Energy Society General Meeting, 2010 IEEE*, 2010, pp. 1–7.

- [95] “Ieee standard for local and metropolitan area networks part 16: Air interface for broadband wireless access systems,” *IEEE Std 802.16-2009 (Revision of IEEE Std 802.16-2004)*, pp. 1–2080, 2009.
- [96] A. Zaballos, A. Vallejo, and J. Selga, “Heterogeneous communication architecture for the smart grid,” *Network, IEEE*, vol. 25, pp. 30–37, 2011.
- [97] E. Biglieri, “Coding and modulation for a horrible channel,” *Communications Magazine, IEEE*, vol. 41, no. 5, pp. 92–98, 2003.
- [98] S. Galli, A. Scaglione, and Z. Wang, “For the grid and through the grid: The role of power line communications in the smart grid,” *Proceedings of the IEEE*, vol. 99, pp. 998–1027, 2011.
- [99] Federal Communications Commission, “Inquiry Regarding Carrier Current Systems, including Broadband over Power Line Systems,” ITU-T, Tech. Rep. FCC 03-100, 2003.
- [100] S. Galli, A. Scaglione, and Z. Wang, in *Smart Grid Communications (SmartGridComm), 2010 First IEEE International Conference on, title=Power Line Communications and the Smart Grid*, oct. 2010, pp. 303 –308.
- [101] National Electrical Manufacturers Association (NEMA), “ANSI C12.22 (Protocol Specification for Interfacing to Data Communication Networks),” April 2013. [Online]. Available: <http://www.nema.org/stds/c12-22.cfm>
- [102] —, “ANSI C12.19 (Utility Industry End Device Data Tables),” April 2013. [Online]. Available: <http://www.nema.org/stds/c12-19.cfm>
- [103] DMLS User Association, “IEC 62056: Device Language Message Specification (DLMS)/ Companion Specification for Energy Metering (COSEM),” 2002.
- [104] ZigBee , “Smart Energy Profile (SEP) 2.0,” 2011.
- [105] “IEEE Draft Standard for Broadband over Power Line Networks: Medium Access Control and Physical Layer Specifications,” *IEEE P1901/D4.01, July 2010*, 2010.

- [106] V. Oksman and J. Zhang, "G.hnem: the new itu-t standard on narrowband plc technology," *Communications Magazine, IEEE*, vol. 49, no. 12, pp. 36–44, 2011.
- [107] "IEEE Draft Standard for Low Frequency (less than 500 kHz) Narrow Band Power Line Communications for Smart Grid Applications[4] Recommendation ITU-T G.9972 (2010), Coexistence mechanism for wireline home networking transceivers." *IEEE P1901/D4.01, July 2010*, 2011.
- [108] "Coexistence mechanism for wireline home networking transceivers," 2010.
- [109] F. Lobo, A. Cabello, A. Lopez, D. Mora, and R. Mora, "Distribution network as communication system," in *SmartGrids for Distribution, 2008. IET-CIRED. CIRED Seminar*, 2008, pp. 1–4.
- [110] C. H. Hauser, D. E. Bakken, I. Dionysiou, K. H. Gjermundrød, V. S. Irava, and A. Bose, "Security, trust and qos in next-generation control and communication for large power systems," *International Journal of Critical Infrastructures*, vol. 2007, 2007.
- [111] ITU-T Study Group 15, "Recommendation ITU-T G.9902: Narrowband orthogonal frequency division multiplexing power line communication transceivers for ITU-T G.hnem networks," ITU-T, Tech. Rep., 2012.
- [112] —, "§Determined Recommendation ITU-T G.9955 §Narrowband OFDM Power Line Communication Transceivers - Physical Layer Specification," ITU-T, Tech. Rep. TD 413 Rev.1 (PLEN/15), 2011.
- [113] —, "Determined Recommendation ITU-T G.9956 §Narrowband OFDM Power Line Communication Transceivers - Data Link Layer Specification," ITU-T, Tech. Rep. TD 412 Rev.1 (PLEN/15), 2011.
- [114] N. I. of Standards and T. (NIST), "Advanced encryption standard (aes)," 2001.
- [115] —, "Block cipher modes of operation: The ccm mode for authentication and confidentiality," 2004.
- [116] F. Corripio, J. Arrabal, L. del Rio, and J. Munoz, "Analysis of the cyclic short-term variation of indoor power line channels," *Selected*

- Areas in Communications, IEEE Journal on*, vol. 24, no. 7, pp. 1327–1338, 2006.
- [117] F. Canete, L. Dítez, J. Cortes, and J. Entrambasaguas, “Broad-band modelling of indoor power-line channels,” *Consumer Electronics, IEEE Transactions on*, vol. 48, no. 1, pp. 175–183, 2002.
- [118] V. Degardin, M. Lienard, A. Zeddani, F. Gauthier, and P. Degauque, “Classification and characterization of impulsive noise on indoor power-line used for data communications,” *Consumer Electronics, IEEE Transactions on*, vol. 48, no. 4, pp. 913–918, 2002.
- [119] M. Zimmermann and K. Dostert, “Analysis and modeling of impulsive noise in broad-band powerline communications,” *Electromagnetic Compatibility, IEEE Transactions on*, vol. 44, no. 1, pp. 249–258, 2002.
- [120] L. Di Bert, P. Caldera, D. Schwingshackl, and A. Tonello, “On noise modeling for power line communications,” in *Power Line Communications and Its Applications (ISPLC), 2011 IEEE International Symposium on*, 2011, pp. 283–288.
- [121] H. Meng, Y. Guan, and S. Chen, “Modeling and analysis of noise effects on broadband power-line communications,” *Power Delivery, IEEE Transactions on*, vol. 20, no. 2, pp. 630–637, 2005.
- [122] G. Srinivasa Prasanna, A. Lakshmi, S. Sumanth, V. Simha, J. Bapat, and G. Koomullil, “Data communication over the smart grid,” in *Power Line Communications and Its Applications, 2009. ISPLC 2009. IEEE International Symposium on*, 2009, pp. 273–279.
- [123] O. Hooijen, “A channel model for the residential power circuit used as a digital communications medium,” *IEEE Trans. Electromagn. Compat.*, vol. 40, no. 4, pp. 331–336, Nov 1998.
- [124] K. Razazian, A. Kamalizad, M. Umari, Q. Qu, V. Loginov, and M. Navid, “G3-plc field trials in u.s. distribution grid: Initial results and requirements,” in *Power Line Communications and Its Applications (ISPLC), 2011 IEEE International Symposium on*, april 2011, pp. 153–158.
- [125] A. Aruzuaga, I. Berganza, A. Sendin, M. Sharma, and B. Varadarajan, “Prime interoperability tests and results from field,” in *Smart*

- Grid Communications (SmartGridComm)*, 2010 First IEEE International Conference on, oct. 2010, pp. 126–130.
- [126] MAXIM, “G3-PLC Physical Layer Specification,” April 2013. [Online]. Available: <http://www.maxim-ic.com/products/powerline/pdfs/G3-PLC-Physical-Layer-Specification.pdf>
- [127] “PRIME Alliance,” April 2013. [Online]. Available: http://www.prime-alliance.org/Docs/Ref/PRIME-Spec_v1.3.6.pdf
- [128] A. Chandra and C. Bose, “Performance of single and multichannel coherent reception under rician fading,” *International Journal of Wireless Information Networks*, vol. 16, pp. 81–90, 2009, 10.1007/s10776-009-0091-3. [Online]. Available: <http://dx.doi.org/10.1007/s10776-009-0091-3>
- [129] J. Martinez-Mateo, D. Elkouss, and V. Martin, “Blind reconciliation,” *Quantum Info. Comput.*, vol. 12, no. 9-10, pp. 791–812, Sep. 2012. [Online]. Available: <http://dl.acm.org/citation.cfm?id=2481580.2481585>

List of Acronyms

ACK	Acknowledgement
AES	Advances Encryption System
ADP	Application Data Primitives
AMI	Advanced Metering Infrastructure
APDU	Application Protocol Data Unit
API	Application Programming Interface
AWGN	Additive White Gaussian Noise
BPSK	Binary Phase Shift Keying
BPL	Broadband Power Line
bps	bits per second
CCMP	Counter Mode Cipher Block Chaining Message Authentication Code Protocol
CENELEC	European Committee for Electrotechnical Standardization
CES	Channel Estimation Symbols
CHP	Combined Heat and Power
CM	Centralized Mode
DAP	Domain Access Point
dB	Decibel
DBPSK	Differential Binary Phase Shift Keying

DER	Distributed Energy Resources
DGM	Distribution Grid Management
DM	Domain Master
DMS	Distribution Management Systems
DOE	Department of Energy
D-OSGi	Distributed Open Service Gateway Initiative
DQPSK	Differential Quadrature Phase Shift Keying
DR	Demand Response
EMS	Energy Management System
EPRI	Electric Power Research Institute
ET	Electric Transportation
ETP	European Technology Platform
FB	Fragment Buffer
FCC	Federal Communication Commission
FEC	Forward Error Correction
FER	Frame Error Rate
FFT	Fast Fourier Transform
GI	Guard Interval
GoS	Grade of Service
GUI	Graphical User Interface
HAN	Home Area Network
HCS	Header Check Sequence
HEMS	Home Energy Management System
HG	Home Gateway

HTTP	Hypertext Transfer Protocol
HVAC	Heating, Ventilation, and Air Conditioning
ICT	Information and Communications Technology
IDB	Intra Domain Bridge
IEC	International Electrotechnical Commission
IDFT	Inverse Discrete Fourier Transform
IFFT	Inverse Fast Fourier Transform
IP	Internet Protocol
IPv6	Internet Protocol version 6
ITU	International Telecommunications Union
JAR	Java ARchive
kWh	Kilowatt hour
LCDU	Link Control Data Unit
LFH	LLC Frame Header
LFSR	Linear Feedback Shift Registers
LLC	Logical Link Control
LPDU	Link Protocol Data Unit
LPH	LPDU Header
LV	Low Voltage
MAC	Medium Access Control
MDMS	Meter Data Management System
MIC	Message Integrity Code
MPDU	MAC Protocol Data Unit
MMH	Management Message Header

NACK	Negative Acknowledgement
NAN	Neighborhood Area Network
NB	Narrowband
NIST	National Institute of Standards and Technology
OFDM	Orthogonal Frequency-Division Multiplexing
OSI	Open System Intercommunication
OSGi	Open Service Gateway Initiative
OWL	Ontology Web Language
PCS	Physical Coding Sublayer
PEV	Plug-in Electric Vehicle
PFH	Physical Frame Header
PHEV	Plug-in Hybrid Electric Vehicle
PHY	Physical
PLC	Power Line Communication
PMA	Physical Media Attachment
PMD	Physical Medium Dependent
PSD	Power Spectral Density
PRBS	Pseudo-Random Binary Sequence
QAM	Quadrature Amplitude Modulation
QoS	Quality of Service
QPSK	Quadrature Phase Shift Keying
RDF	Resource Description Framework
RPC	Residential Power Circuits
RS	Reed-Solomon

SCADA	Supervisory Control and Data Acquisition
SDK	Software Development Kit
SG	Smart Grid
SNR	Signal to Noise Ratio
SOA	Service Oriented Architecture
SOAP	Simple Object Access Protocol
SPARQL	SPARQL Protocol and RDF Query Language
SQL	Structured Query Language
SQWRL	Semantic Query-Enhanced Web Rule Language
SWRL	Semantic Web Rule Language
UM	Unified Mode
WASA	Wide-Area Situational Awareness
WSDL	Web Service Definition Language
W3C	World Wide Web Consortium
XML	Extensible Markup Language

