



## Multidisciplinary Free Material Optimization of 2D and Laminate Structures

Weldeyesus, Alemseged Gebrehiwot; Stolpe, Mathias; Gaile, Stefanie

*Publication date:*  
2014

*Document Version*  
Peer reviewed version

[Link back to DTU Orbit](#)

*Citation (APA):*

Weldeyesus, A. G. (Author), Stolpe, M. (Author), & Gaile, S. (Author). (2014). Multidisciplinary Free Material Optimization of 2D and Laminate Structures. Sound/Visual production (digital)

---

### General rights

Copyright and moral rights for the publications made accessible in the public portal are retained by the authors and/or other copyright owners and it is a condition of accessing publications that users recognise and abide by the legal requirements associated with these rights.

- Users may download and print one copy of any publication from the public portal for the purpose of private study or research.
- You may not further distribute the material or use it for any profit-making activity or commercial gain
- You may freely distribute the URL identifying the publication in the public portal

If you believe that this document breaches copyright please contact us providing details, and we will remove access to the work immediately and investigate your claim.

# Multidisciplinary Free Material Optimization of 2D and Laminate Structures

Alemseged G Weldeyesus, PhD student  
 Mathias Stolpe, Senior Scientist  
 Stefanie Gaile

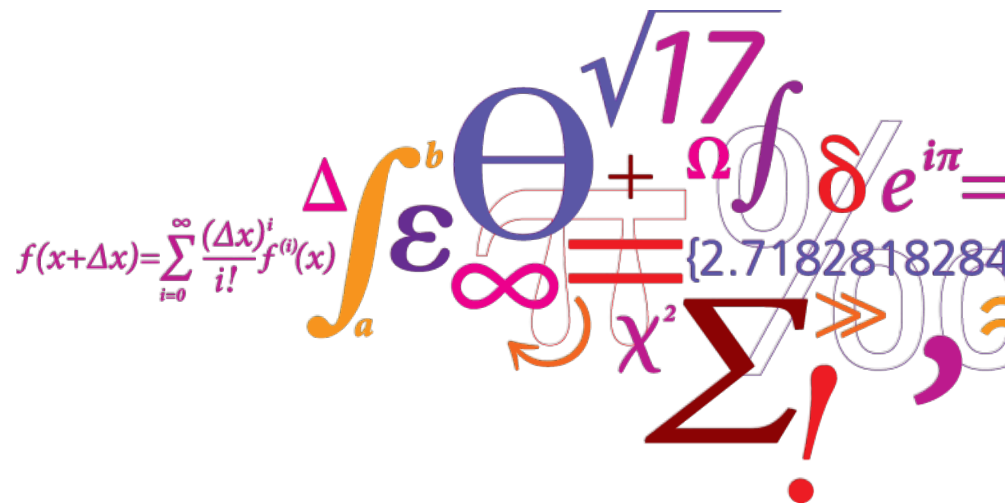

# Free Material Optimization (FMO)

FMO is a one of the different approaches to structural optimization.

In FMO,

- the design variable is the **full material tensor**,
- can vary freely at each point of the design domain,
- necessary condition for physical attainability is the only requirement.

M. P. Bendsøe, J. M. Guedes, R. B. Haber, P. Pedersen, and J. E. Taylor. An analytical model to predict optimal material properties in the context of optimal structural design. *J. Appl. Mech. Trans. ASME*, 61:930–937, 1994.

M. Kočvara and M. Stingl. Free material optimization for stress constraints. *Structural and Multidisciplinary Optimization*, 33:323-335, 2007.

M. Kočvara, M. Stingl, and J. Zowe. Free material optimization: Recent progress. *Optimization*, 57(1):79–100, 2008.

# Optimal solution

- Solution to FMO yields optimal distribution of the material as well as optimal local material properties.
- The obtained design can be considered as an ultimately best structure.
- Conceptual, since it is difficult (or actually impossible) to manufacture a structure such that its property varies at each point of the design.
- FMO can be used to generate benchmarks and to propose novel ideas for new design situations.

# The FMO problem formulation

Mechanical assumptions

- static loads,
- linear elasticity,
- anisotropic material.

The basic minimum compliance problem (Discrete)

$$\begin{aligned}
 & \min_{u_l, E} && \sum_l w_l f_l^T u_l \\
 & \text{subject to} && K(E)u_l = f_l, \quad l = 1, \dots, L \\
 & && \underline{\rho} \leq \text{Tr}(E_i) \leq \bar{\rho}, \quad i = 1, \dots, m \\
 & && E_i - \delta I \succeq 0, \quad i = 1, \dots, m \\
 & && \sum_{i=1}^m \text{Tr}(E_i) \leq \bar{V}
 \end{aligned}$$

2D, 3D structures

Additional structural requirements can also be included through constraints

- on local stresses  $\sum_{k=1}^G \|E_i B_{ik} u\|^2 \leq s_\sigma$
- on local strains  $\sum_{k=1}^G \|B_{ik} u\|^2 \leq s_\sigma$
- on displacement  $Cu \leq d$

Adding such constraints destroys suitable problem properties, e.g. convexity.

# Goals

- Propose FMO model for laminate structures.
- Extend existing robust and efficient primal dual interior point method for nonlinear programming to FMO problems. ( second order method)

# FMO for laminate structures

Based on FSDT

$$\begin{bmatrix} \sigma_{11} \\ \sigma_{22} \\ \sigma_{23} \\ \sigma_{31} \\ \sigma_{12} \end{bmatrix} = \begin{bmatrix} C_{11} & C_{12} & 0 & 0 & C_{16} \\ C_{12} & C_{22} & 0 & 0 & C_{26} \\ 0 & 0 & C_{44} & C_{45} & 0 \\ 0 & 0 & C_{45} & C_{55} & 0 \\ C_{16} & C_{26} & 0 & 0 & C_{66} \end{bmatrix} \begin{bmatrix} \varepsilon_{11} \\ \varepsilon_{22} \\ \varepsilon_{23} \\ \varepsilon_{31} \\ \varepsilon_{12} \end{bmatrix}$$

$$C = \begin{bmatrix} C_{11} & C_{12} & C_{16} \\ C_{12} & C_{22} & C_{21} \\ C_{16} & C_{21} & C_{66} \end{bmatrix}, \quad D = \begin{bmatrix} C_{44} & C_{45} \\ C_{54} & C_{55} \end{bmatrix}$$

Minimum compliance problem

$$\begin{aligned} & \min_{u_l, \theta_l, C, D} \sum_l w_l c(u_l, \theta_l) \\ & \text{subject to} \quad K(C, D)(u_l, \theta_l) = f_l, \quad l = 1, \dots, L \\ & \quad \underline{\rho} \leq t_k \text{Tr}(C_{ik}) + \frac{1}{2} t_k \text{Tr}(D_{ik}) \leq \bar{\rho}, \quad i = 1, \dots, m, k = 1, \dots, N \\ & \quad C_{ik} - \delta I \succeq 0, D_{ik} - \delta I \succeq 0, \quad i = 1, \dots, m, k = 1, \dots, N \\ & \quad \sum_{i,k} (t_k \text{Tr}(C_{ik}) + \frac{1}{2} t_k \text{Tr}(D_{ik})) \leq \bar{V} \end{aligned}$$

# Optimization method

- All FMO problems are SemiDefinite Programs (SDP), [an optimization problem with many matrix inequalities](#).
- On the extension of primal-dual interior point methods for nonlinear programming to FMO problems (SDP).
- FMO problems can be represented by

$$\begin{aligned} & \min_{X \in \mathbf{S}, u \in \mathbf{R}^n} && f(X, u) \\ & \text{subject to} && g_j(X, u) \leq 0, && j = 1, \dots, k \\ & && X_i \succeq 0, && i = 1, \dots, m \end{aligned} \quad (P)$$

$f : \mathbf{S} \times \mathbf{R}^n \rightarrow \mathbf{R}$ ,  $g : \mathbf{S} \times \mathbf{R}^n \rightarrow \mathbf{R}^k$ , sufficiently smooth.

Introducing slack variables, the associated barrier problem is

$$\begin{aligned} & \min_{X \in \mathbf{S}, u \in \mathbf{R}^n, s \in \mathbf{R}^k} && f(X, u) - \mu \sum_i \ln(\det(X_i)) - \mu \sum_j \ln(s_j) \\ & \text{subject to} && g_j(X, u) + s_j = 0, && j = 1, \dots, k \end{aligned} \quad (BP)$$

We solve problem (BP) for a sequence of barrier parameter  $\mu_k \rightarrow 0$ .



# Numerical results

Without stress constraints

- 28800 design variables,
- ~9600 nonlinear constraints,
- 4800 matrix inequalities

Design domain,  
bc, forces

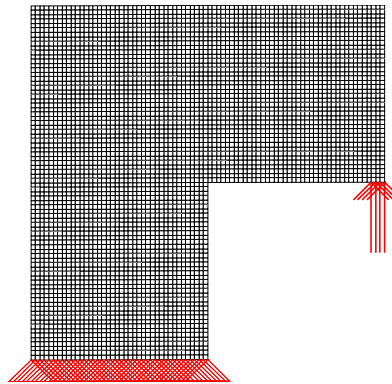

Optimal density  
distribution

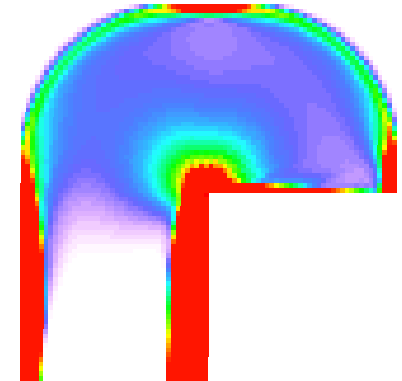

Optimal strain norms

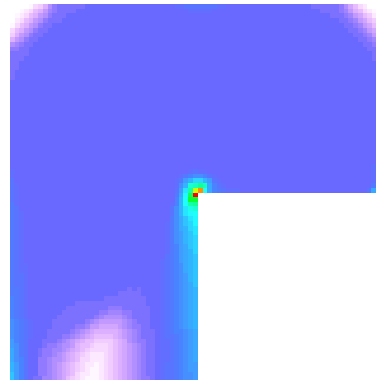

Optimal stress norms

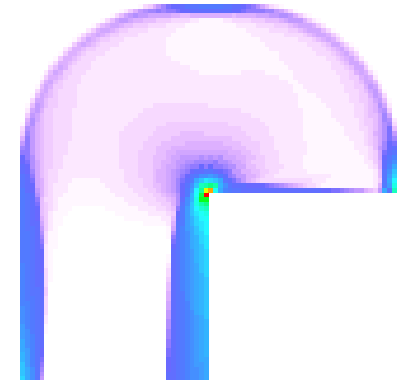

- 43 iterations
- Higher stress concentration around the re-entrant corner

# Numerical results ...

With stress constraints (max stress is decreased by 30%)

- 28800 design variables
- ~9600 nonlinear constraints
- 4800 matrix inequalities
- 4800 additional nonlinear constraints (stress constraints)

- 72 iterations
- Higher stress concentrations are distributed to neighbour regions

Optimal density distribution

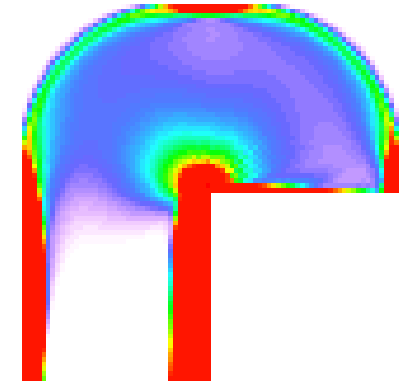

Optimal strain norms

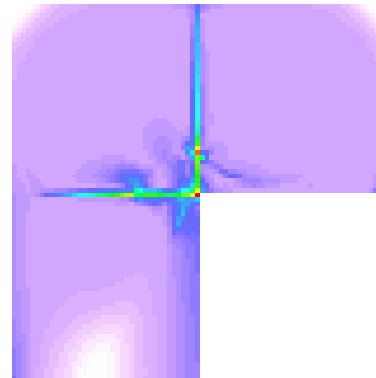

Optimal stress norms

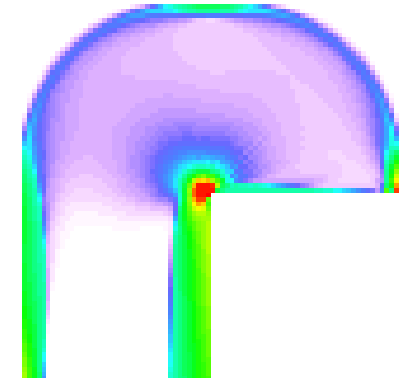

M. Kočvara and M. Stingl. Free material optimization for stress constraints. *Structural and Multidisciplinary Optimization*, 33:323-335, 2007.

# Numerical results ...

4 layers

Design domain, bc and forces

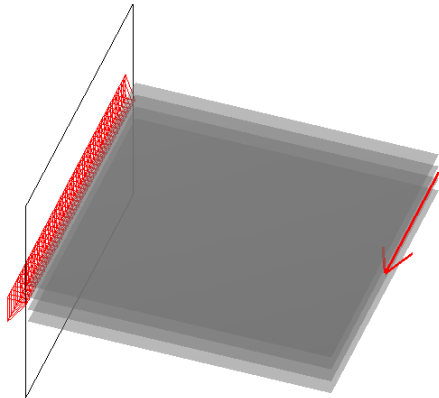

## Optimal density distribution

Optimal density distribution, Layer=1

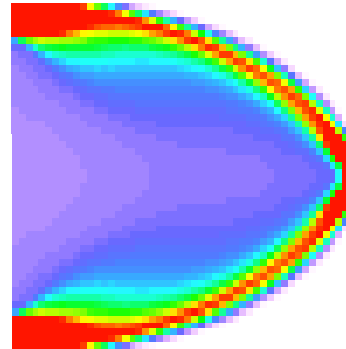

Optimal density distribution, Layer=2

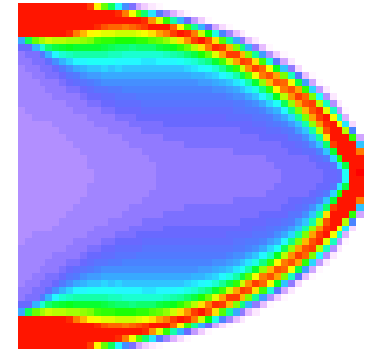

Optimal density distribution, Layer=3

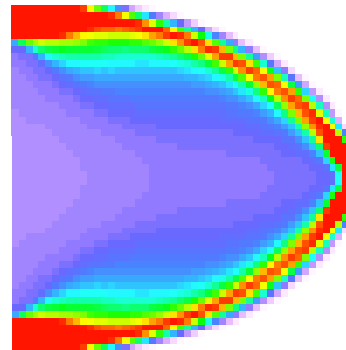

Optimal density distribution, Layer=4

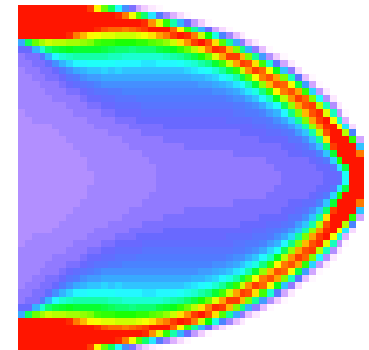

- No distinction between layers.
- Similar to 2D results.
- No out plane deformation.
- No material for D,

$$\min(\text{trace}(C))/\max(\text{trace}(D))=2.2413$$

# Numerical results ...

4 layers

- 129600 design variables
- 28800 matrix inequalities

Design domain, bc and forces

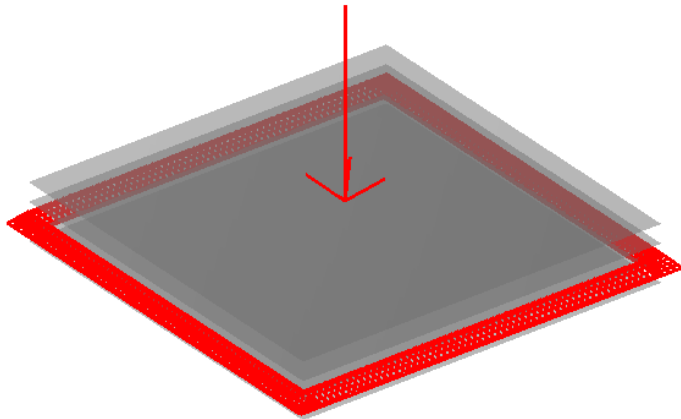

- 47 iterations
- Symmetric laminate
- High material distribution on top and bottom layers

## Optimal density distribution

Optimal density distribution, Layer=1

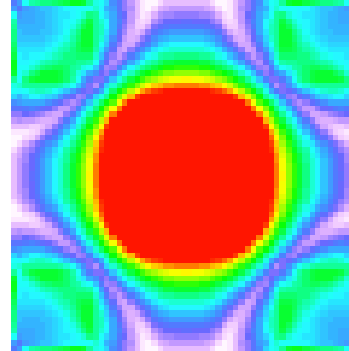

Optimal density distribution, Layer=2

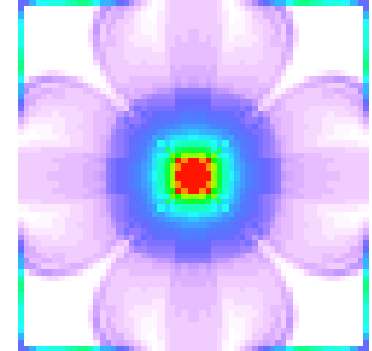

Optimal density distribution, Layer=3

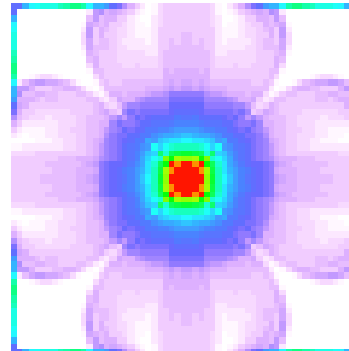

Optimal density distribution, Layer=4

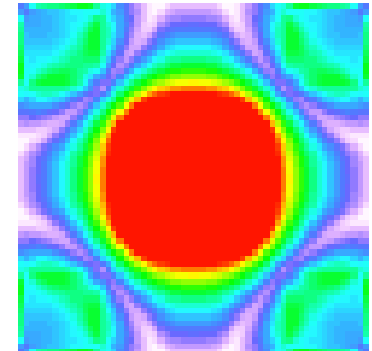

# Numerical results ...

In both cases, we have

- single layer,
- 90000 design variables,
- 20000 matrix inequalities.

Design domain, bc and forces

Optimal density distribution

44 iterations

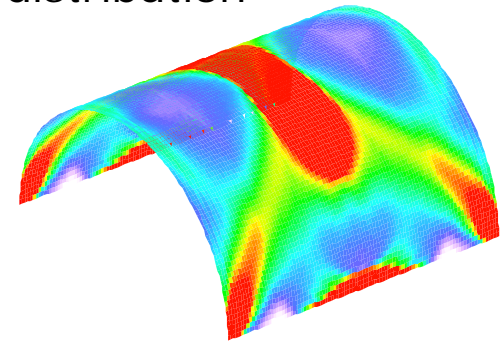
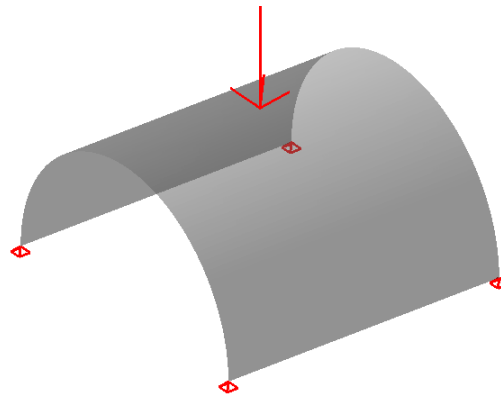

47 iterations

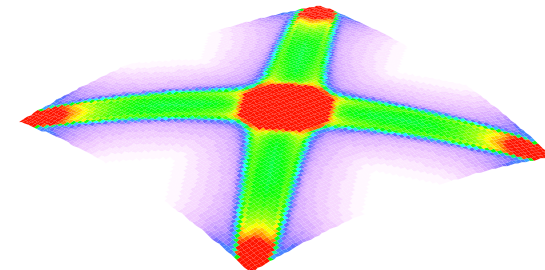
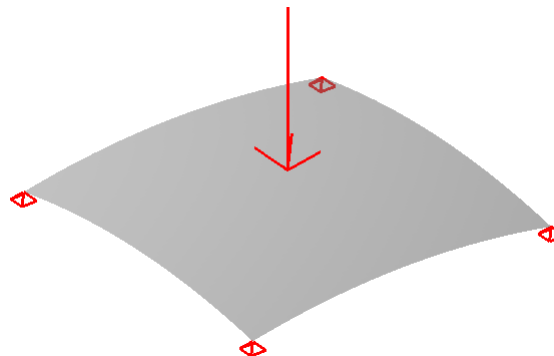

# Conclusion

- The extended primal dual interior point method solves FMO problems in a reasonable number of iterations.
- Number of iterations is almost independent to problem size.
- FMO has been extended to optimal design of laminate structures.

Thank you for your attention !