



## High efficient ammonia heat pump system for industrial process water using the ISEC concept. Part 1

Rothuizen, Erasmus Damgaard; Madsen, C. ; Elmegaard, Brian; Olesen, M.; Markussen, Wiebke Brix

*Published in:*

Proceedings of 11th IIR Gustav Lorentzen Conference on Natural Refrigerants

*Publication date:*

2014

*Document Version*

Publisher's PDF, also known as Version of record

[Link back to DTU Orbit](#)

*Citation (APA):*

Rothuizen, E. D., Madsen, C., Elmegaard, B., Olesen, M., & Markussen, W. B. (2014). High efficient ammonia heat pump system for industrial process water using the ISEC concept. Part 1. In *Proceedings of 11th IIR Gustav Lorentzen Conference on Natural Refrigerants* Chinese Association of Refrigeration.

---

### General rights

Copyright and moral rights for the publications made accessible in the public portal are retained by the authors and/or other copyright owners and it is a condition of accessing publications that users recognise and abide by the legal requirements associated with these rights.

- Users may download and print one copy of any publication from the public portal for the purpose of private study or research.
- You may not further distribute the material or use it for any profit-making activity or commercial gain
- You may freely distribute the URL identifying the publication in the public portal

If you believe that this document breaches copyright please contact us providing details, and we will remove access to the work immediately and investigate your claim.

# HIGH EFFICIENT AMMONIA HEAT PUMP SYSTEM FOR INDUSTRIAL PROCESS WATER USING THE ISEC CONCEPT - PART I

E. Rothuizen<sup>a</sup>, C. Madsen<sup>b</sup>, B. Elmegaard<sup>a</sup>, M. Olesen<sup>b</sup> and W. B. Markussen<sup>a</sup>

<sup>a</sup> *Technical University of Denmark, Copenhagen, Denmark, edro@mek.dtu.dk*

<sup>b</sup> *Danish Technological Institute, Copenhagen, Denmark, clma@teknologisk.dk*

**Abstract** The purpose of the Isolated System Energy Charging (ISEC) is to provide a high-efficient ammonia heat pump system for hot water production. The ISEC concept uses two storage tanks for the water, one discharged and one charged. The charged tank is used for the industrial process while the discharged tank, is charging. Charging is done by circulating the water in the tank through the condenser several times and thereby gradually heats the water. This result in a lower condensing temperature than if the water was heated in one step. A dynamic model of the system, implemented in Dymola, is used to investigate the performance of the ISEC system. The ISEC concept approaches the efficiency of a number of heat pumps in series and the COP of the system may reach 6.8, which is up to 25 % higher than a conventional heat pump heating water in one step.

**Keywords:** ISEC, heat pump, hot water production, storage.

## 1. INTRODUCTION

This paper is the first of two papers considering the ISEC system. The paper second paper called “High efficient ammonia heat pump system for industrial process water using the ISEC concept – Part II” (Olesen, et al., 2014) is a separate paper, but can be seen as a continuation of this paper. This paper is theoretical whereas the second paper also contains tests of the tank system used for the ISEC concept.

The long-term Danish energy policy objective is to be fossil fuel free by 2050 and to produce heat and electricity from fossil fuel free energy resources by 2035. The Danish engineering association (IDA) has made a Climate Plan 2050 recommending increasing the wind turbine share to cover 67% of the electricity consumption by 2030 and correspondingly implement photo voltage to cover 2% of the electricity consumption (The Danish Society of Engineers IDA, 2009). The large amount of electricity produced from wind and solar energy means that electricity is going to be the principal energy carrier and that significant fluctuations in electricity production at national level may occur. Industrial heat pump systems produce process heat for a given demand at a defined temperature lift of the heat sink. The efficiency of a conventional heat pump system comprising a vapour compression cycle is limited compared to the theoretical limit defined by the Carnot and Lorenz cycles, by compressor efficiency, throttling and temperature differences between fluids in condenser and evaporator. The possibilities for further optimization without utilizing alternative cycle configurations or working fluids are limited due to state-of-the-art of component design. Optimization of the conventional heat pump system may thus be based on new approaches and system designs. New heat pump solution should preferably be designed and implemented with high energy efficiency, while the flexibility of consumption and production as well as economics should not be compromised. The use of heat pumps for producing hot water for industrial processes is common in larger production facilities, such as dairies, slaughter houses, heated areas for livestock, utility heating in office buildings, and district heating networks (Becker, et al., 2011) (Zvingilaite, et al., 2012) (Ommen, et al., 2014) (Ommen, et al., 2014). Typically hot water at temperatures in a range of 40 – 90°C is used. The ISEC concept can be used in all of the mentioned heat productions. The system approached in this paper is a new system design enabling gradual heating of water using recirculation instead of heating to demand temperature in one single passage of the condenser, as the traditional heat pump does. It corresponds to having heat pumps in series, which has been proven to increase the COP (Wang, et al., 2010). The use of the ISEC concept can potentially increase the efficiency of existing (new condenser is needed) and new heat pump systems significantly. At the same time, the concept makes it possible to accumulate heat in the tanks. This paper presents the ISEC concept using ammonia as refrigerant and compares it to a conventional ammonia heat pump system with regards to Coefficient of Performance (COP) and energy consumption.

## 1.1. The ISEC concept

A conventional heat pump system used to heat water for industrial processes is shown in figure 1. The heat pump heats the water from the return temperature, e.g.  $T_{1'} = 40\text{ }^{\circ}\text{C}$  directly to the temperature used for the process e.g.  $T_2' = 80\text{ }^{\circ}\text{C}$ . Therefore, conventional system will also be referred to as a direct heat pump.

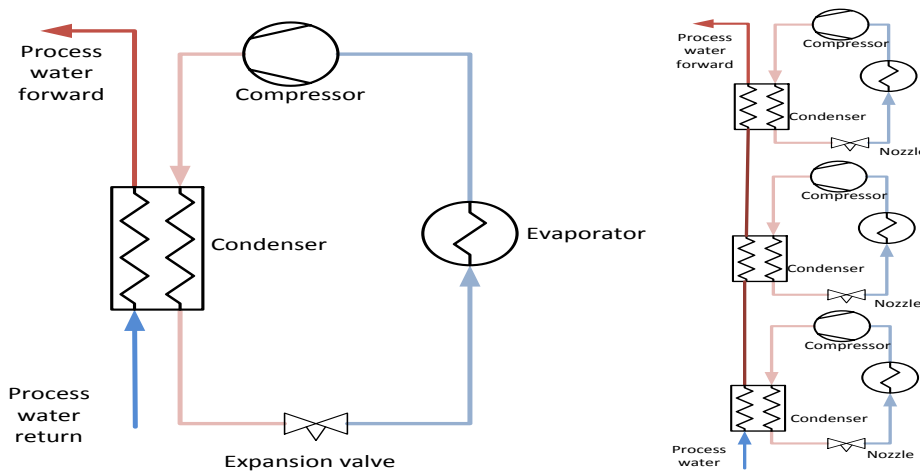

**Figure 1 – Left: Conventional heat pump system for water heating for industrial processes. Right: Three heat pumps in series.**

The production of hot water may be continuous, as it delivers directly for to the water circuit. The idea of the Isolated System Energy Charging comes from considering several heat pumps in series as shown in figure 1 Right. Considering the two systems in figure 1, both heats the water from  $40\text{ }^{\circ}\text{C}$  to  $80\text{ }^{\circ}\text{C}$ , though the 3 heat pumps in series heats the water gradually as it passes each condenser. The temperature lift of each condenser is equal. The difference between using only one heat pump and 3 in series is shown in figure 2, the efficiency of the compressors have been disregarded, hence the difference between the two systems is only due to the difference in temperatures in the condenser.

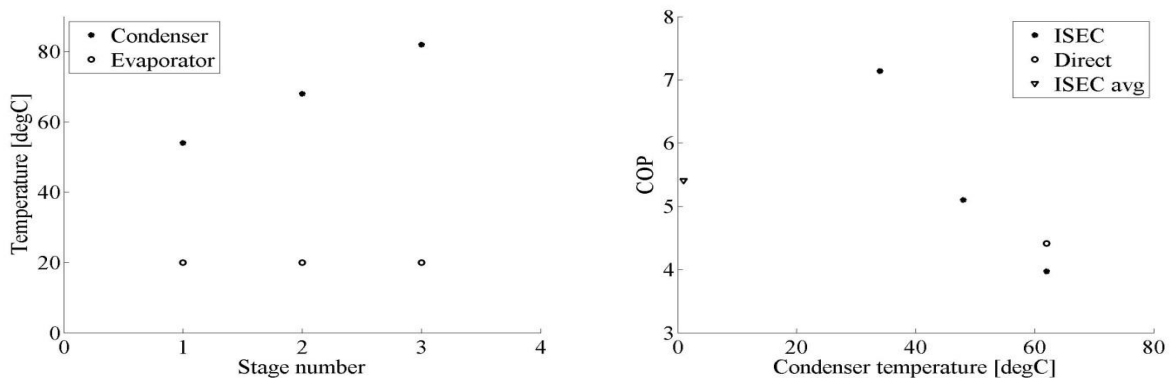

**Figure 2 - Temperature difference for 3 heat pumps in series and the COP for each heat pump compared with the direct heating heat pump and the average COP for the 3 heat pump in series.**

The condenser temperature must be a little higher than the outlet temperature of the water, thus it will be at least  $80\text{ }^{\circ}\text{C}$ . This results in entropy generation, and accordingly, a lower COP. If heating is done stepwise, the condenser of each step only needs to operate at the water outlet temperature of this step. The condenser and evaporator temperatures of each heat pump are shown in the left figure and the COP of each stage are shown in the right figure together with the average COP of the series of heat pumps and the COP of the conventional heat pump, heating directly from  $40\text{ }^{\circ}\text{C}$  to  $80\text{ }^{\circ}\text{C}$  in one step. For this simple analysis the COP for the direct heating system is 4.4 and the average COP for the serial system is 5.4, thus an improvement of almost 20%. This improvement is closely related to savings of operating expenses. The ISEC concept may achieve the same performance as a series of heat pumps, using a single heat pump only. The ISEC based heat pump system delivers a continuous supply of hot water, but by means of a tank system instead of several heat pumps in series. In the ISEC based heat pump system, there is a gradual heating of water in a tank with

an increasing condensation temperature in the thermodynamic cycle until the desired temperature has been reached. The water is recirculated a number of times through the condenser from the tank. Subsequently, the process is repeated by heating the water in the second tank (charging) while the water in the first tank is used for industrial process heating (discharging). The ISEC system is shown in Figure 3. The discharged water is used for heating, while the tank is filled with cold water, but maintaining temperature stratification in the tank. The cold water will be in the bottom of tank and heated water in the top. The principle described above is most relevant if there is a relatively large temperature difference between the inlet temperature of the cold water and the outlet temperature of the hot water for the industrial process. Traditionally, as shown in figure 1, a direct heating from the inlet temperature to the outlet temperature is carried out simultaneously by means of the heat pump. In principle, this can be done with or without storage of water. The ISEC heat pump system involves heating of water in a tank with a gradually increasing temperature e.g. heating the water 4 °C per circulation of the water. The ISEC concept requires several recirculations of the charging water to obtain the final temperature of process water. The mass flow rate of the recirculation stream is higher than for the discharging tank in order for the tank to be charged when the discharging tank is empty assuring continuous availability of process water.

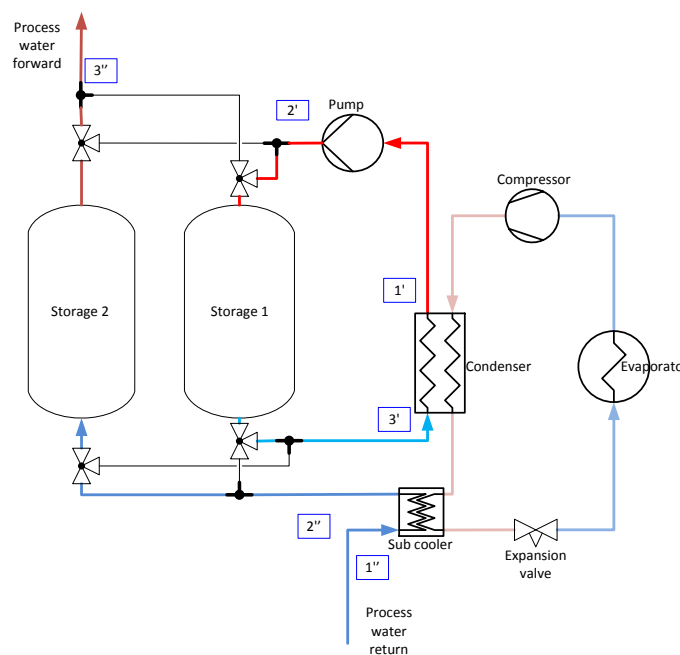

**Figure 3 - A principle sketch of the ISEC system. The blue lines are cold streams while red lines are hot streams. The light blue stream passing 3' is cold water that is circulated to the condenser. The red line passing 1' is the heated water filled to the tank. The brown line passing 3'' is hot water used for the industrial process while the dark blue line passing 1'' and 2'' is the return water from the industrial process. The subcooler between 1'' and 2'' is not necessary for the process.**

This method results in the achievement of a substantial improvement in heat pump efficiency as it only needs to raise the temperature a relatively few degrees. Initially, the heat pump operates at a low temperature while it operates at a substantially higher temperature at the end of the process. This increase in temperature affects the heat pump efficiency; it approaches the COP of a cycle operating at the thermodynamic average temperature of the water. To ensure low losses in the process during discharge, a good stratification of the water in the tanks should be maintained so that, in principle, there is an infinitely small layer of separation between hot and cold water. The stratification comes naturally as hot water remains in to the top of the tank and cold water in the bottom due to the differences in density. However, a number of factors cause a degradation of the stratification. The two main concerns are 1) The inlet of water in the tanks can cause disturbance and mixing of the two water volumes and 2) Heat conduction between the water layers and in the tank wall results in temperature equalization. By proper design of the inlets and the tanks, it is assumed to be possible to maintain a good stratification.

## 2. METHODS

The calculations comparing the conventional direct heating system with the ISEC concept have been implemented in Dymola. Dymola is dynamic modelling software that solves differential-algebraic systems of equations numerically. The different components in the system are modelled based on a control volume formulation based on lumped parameters. The models are connected in Dymola and the performance of the whole system can be analysed.

## 2.1. Component models

The different components modelled are: compressor, condenser, evaporator, subcooler, storage tank, pump, and expansion valve. All the models are based on the first thermodynamic principles, mass and energy balance. The compressor is modelled by volumetric efficiency and isentropic efficiency. The volumetric efficiency is assumed to be 0.9 for a pressure ratio of 1 and decreases with 5 % per increased pressure ratio across the compressor. The volumetric efficiency results in a decrease in mass flow rate of refrigerant with an increase in pressure ratio. The isentropic efficiency is assumed to have a constant value during the process. The condenser model is divided into two parts, the super-heated gas and the condensing gas both are based on the logarithmic mean temperature difference method (Incropera, et al., 2007). The heat transfer coefficients for both single phase flow refrigerant and water are found using the correlations for a plate heat exchanger described by Holger Martin (Martin, 1996). For the two-phase flow refrigerant a correlation from Yan (Yan, et al., 1999) is used. The subcooler uses the logarithmic mean temperature difference and the heat transfer correlations for single phase flow in a plate heat exchanger by Holger Martin (Martin, 1996). The evaporator is a simpler model based only on energy, mass balance and a constant temperature source and constant evaporating temperature. The storage tanks are modelled as control volumes with dynamic mass and energy content. Internally they contain either one or two control volumes, which each contain water at a spatially constant temperature which varies over time (Rothuizen, 2013). For the charging tank no stratification is assumed, so the water entering is fully mixed with the water inside the tank, resulting in a gradual heating of the water in the tank. When discharging, the tank is stratified with the high temperature level at the top of the lower temperature of the returning water. The pump model assumes a constant isentropic efficiency. The power consumption is based on the required head due to pressure loss in the system and the flow. The expansion valve is modelled as an isenthalpic process. The tank models are the only models that are dynamic. The other component models are quasi-static so the changes in these models are a consequence of the change in the tanks, which is caused by the heating and cooling in the system.

## 2.2. Test case

The refrigerant for all the systems is ammonia (R717). The initial temperature of the water is 40 °C and the temperature needed for the process is 80 °C. The process needs a mass flow rate of 16.6 kg/s of hot water. The storage tanks are 10 m<sup>3</sup> each and with the given mass flow rate the tank discharges in 10 minutes (600 seconds). The other tank therefore needs to be charged in 10 minutes. The charging tank mixes the entering water with the existing water in the tank fully, while the tank which is discharged is stratified with the hot water used for process in the top and the returning water in the bottom. The ISEC system increases the water temperature with approximately 4 °C for each circulation of the water. It thus recirculates the water 10 times before reaching target temperature while the direct system heats the water in one temperature lift, hence the ISEC system has a 10 times higher mass flow rate. The pressure loss in the condenser is constant at 0.5 bar for all calculations. The evaporating temperature is 22°C. The compressor is assumed to have a constant isentropic efficiency of 50 %, unless other is specified. The ISEC solution is compared to a conventional system. The condensing temperature for the conventional heat pump system is 81, °C. This gives a minimum temperature difference of 41 °C. Except for the condenser the heat pump is assumed to be based on the same components for both a conventional system and the ISEC system. The water system will require a significantly larger mass flow for the ISEC process. It is assumed that the pump and the pipe system are dimensioned accordingly. The first part of the analysis is done without using the subcooler indicated in Figure 3 and the last analysis is both with and without subcooling.

## 3. RESULTS

This section presents an analysis of the ISEC system and compares the different results to the conventional direct heating heat pump. The first parameter variation is of the number of times the water is recirculated through the heat exchanger before it reaches the desired temperature. The second parameter variation considers the heat exchanger size for a constant mass flow rate. The third analysis considers the influence of

the evaporator temperature on the COP. The last analysis considers the two systems with and without subcooling and with different isentropic efficiencies of the compressor.

### 3.1. Thermodynamic comparison of the two systems

The conventional direct system and the ISEC system are by means of technology very similar, though the heating process of the water is different. Where the direct system heats the water by passing the condenser once, the water in the ISEC system passes the condenser a number of times and stores the water in tanks. The heating processes of the water for both systems are shown in figure 4 left. The right figure compares the COPs of the 2 systems; the ISEC average and the direct COP are comparable. "ISEC" is the COP at that given stage in the heating process, "ISEC average" is the average COP over the elapsed time and

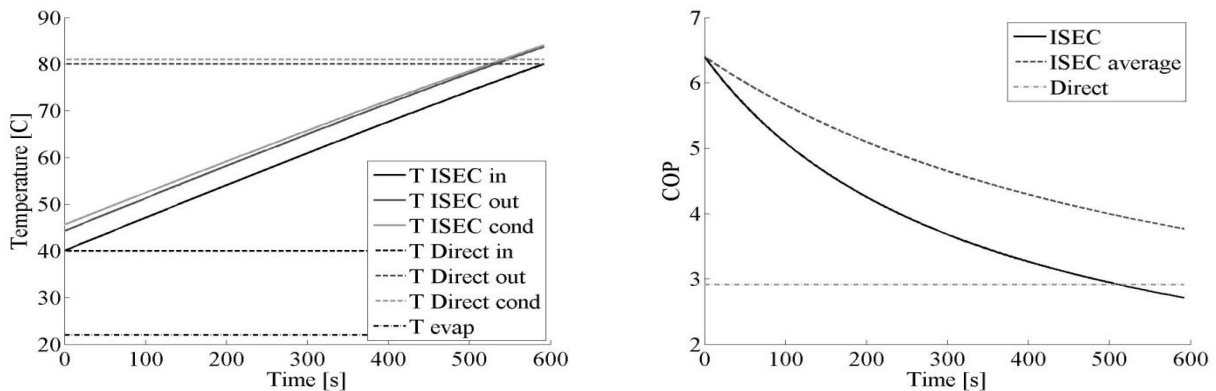
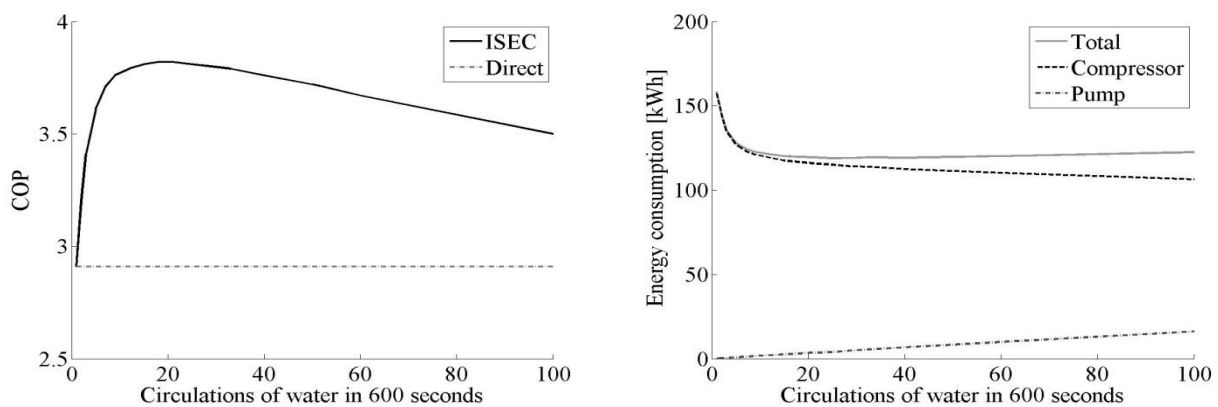

**Figure 4 - The condensing temperature and the in- and outlet temperatures of the water for the direct and ISEC systems. Right: The COP of the ISEC system at the time in the process, the average ISEC COP and the COP of the direct heating system.**

"Direct" is the COP of a conventional heat pump heating in one step. It is shown that the average COP of the ISEC system is higher than the COP of the direct heat pump system and that eventually the ISEC system has a COP that is 3,8. The conventional system has a COP of 2,8 The COP of the ISEC system at a given time is lower than the average COP. For the last 60 s it is lower than for the conventional heat pump system, as the condensing temperature is higher at this point.

### 3.2. The effect of recirculation of the water in the ISEC system

The ISEC system and the conventional system are compared with respect to the number of times



**Figure 5 - Left: COP as a function of recirculation of the water through the condenser. Right: Power consumption as a function of number of recirculations.**

the water is circulated in the ISEC system in 600 seconds. The conventional heat pump, heats up the water from 40 °C to 80°C with only one passage through the condenser, while the ISEC system recirculates the water a number of times. Figure 5 left shows the COP as a function of circulations with reference to the conventional system. Figure 5 left shows that there are an optimum number of recirculations through the

condenser. The optimum number of recirculation for this specific system is 20 and the corresponding COP is 3.8, compared to the conventional heat pump system with a COP of 2.91. This is an increase in COP of 24 %. The reason for the peak in COP is the power consumption of the system in shown in figure 5 right. The graphs shows that the compressor consumption is decreasing while the pump electricity consumption is increasing linearly as the pressure loss is 0.5 bar in all cases, as the water side is assumed to be dimensioned for the required water flow. For a number of recirculation of 20 or more the increase in pumping power becomes larger than the saving in compressor power. The reason for the decrease in compressor power consumption is that the condensing temperature decreases as the number of recirculation increases. The more times the water is circulated, the lower is the temperature increase of the water per circulation and the lower is the average condensing temperature, even though the pinch point temperature increases slightly, which can be seen in figure 6. This analysis shows that the number of circulations has an optimum for the system and that the temperature increase of the water decreases per circulation as the number of circulations increases. Furthermore, the minimum temperature difference of the condenser increases as the circulation rate increases and the condenser temperature decreases.

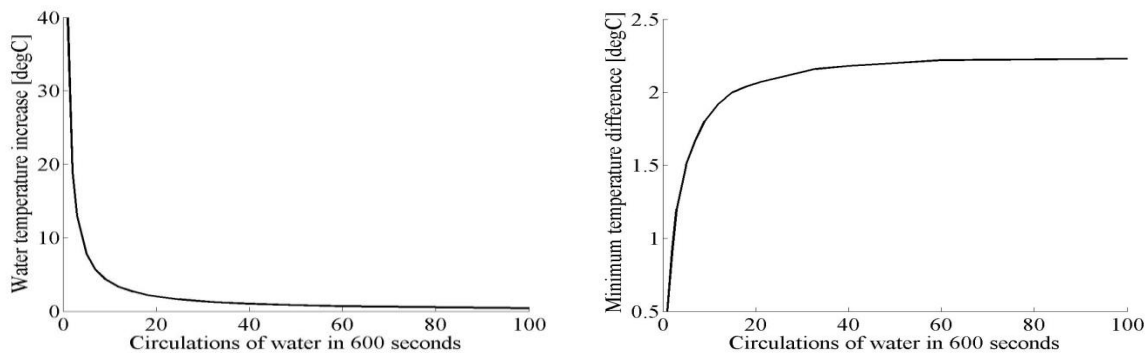

Figure 6 - Temperature difference of water across the condenser as a function of recirculation. Right: Minimum temperature difference as a function of recirculation.

### 3.3. Condenser area and the evaporating temperature

A parameter variation of the heat transfer area of the condenser is done for a constant mass flow rate of water. This shows how the condenser size affects the COP of the system. The mass flow rate corresponds to circulating the water 12 times through the condenser in 600 seconds, 12 circulations is chosen as the COP does not increase significantly by increasing the number of circulations, figure 5 left. Figure 7 left shows the relation between condenser area and the COP. For the conventional heat pump system the heat exchanger

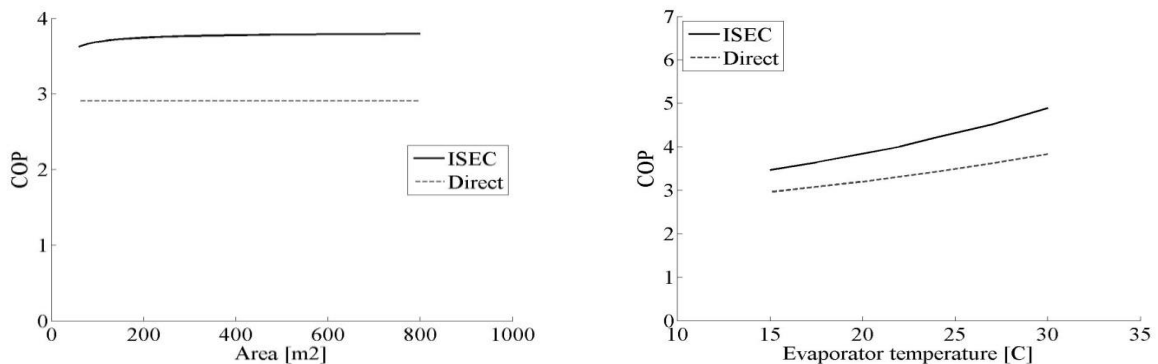

Figure 7 - Left: COP as a function of the condenser area. Right: COP as a function of evaporator temperature.

size does not affect the COP noticeable, as the condenser temperature has to be above 80°C. For the ISEC concept the condenser temperature is always above the outlet temperature of the water, and as the area increases so does the COP. This is because the condensation temperature decreases. The largest marginal increases in COP with respect to condenser size are found below 200 m<sup>2</sup>. The effect of the evaporating temperature on the ISEC system and the conventional heat pump system are shown in figure 7 right. The mass flow rate of the water side of the condenser is constant and the temperature difference between evaporation temperature and the water into the evaporator is 7°C. As the evaporator temperature approaches

the inlet temperature of the water in the condenser, the COP increases for both systems as the volumetric efficiency decreases the mass flow rate of the refrigerant increases, increasing the performance of the condenser. However, the increase of the ISEC system is larger than for the conventional heat pump system.

### 3.4. Compressor efficiency and subcooling

The previous comparisons have been done without including subcooling in the systems and with a constant isentropic efficiency of the compressor of 50%. This section includes subcooling for both systems, where the

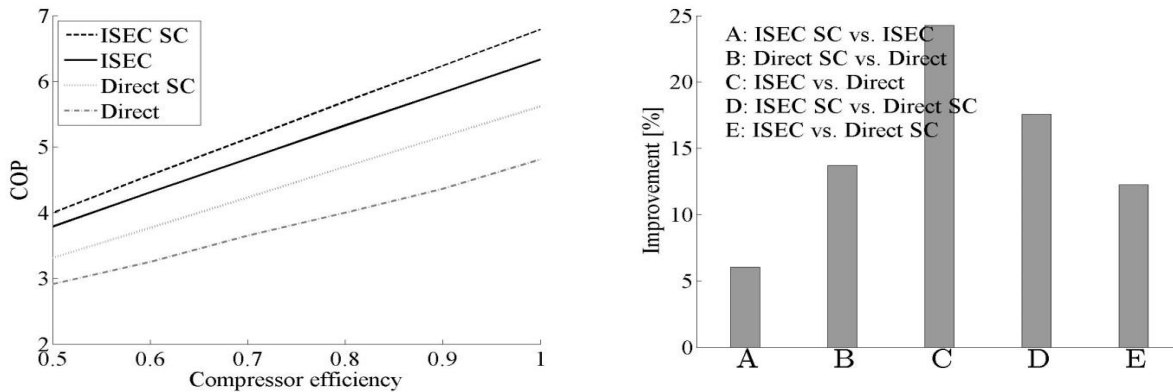

**Figure 8 – Left: COP as a function of isentropic efficiency and subcooling. Right: Reduction of power consumption as a function of system design.**

refrigerant is cooled down to 44°C. Furthermore, a parameter study of the isentropic efficiency of the compressor is included. For the conventional system the subcooling is used to heat up the water before the condenser. In the ISEC system the subcooling is used to heat the returning water to the tank discharging to maintain a constant subcooling in the heat pump. This results in a higher initial temperature when the tank has to be charged after the discharge. Figure 8 left shows the COP as a function of the isentropic efficiency of the compressor, for both systems with and without subcooling. Increasing the isentropic efficiency of the compressor increases the COP linearly for all cases. The better performance of the ISEC system is similar for all the cases. The effect of the subcooling on the systems is significant. The increase in COP with and without subcooling is shown in figure 8 right. The “ISEC” and “Direct” shows the improvement of adding subcooling to the existing system, while the other compare the two systems both with and without subcooling. It is worth noticing that the ISEC system without subcooling has a higher COP than the direct system with subcooling and if the isentropic efficiency of the compressor is 10% lower in the ISEC system, the two systems has the same COP.

## 4. DISCUSSION

The calculations shows the potential benefits of the ISEC system compared to a conventional heat pump. Some possible challenges of the actual implementation of an ISEC system are the stratification in the tanks; the heat transfer in the tanks, both within the water and conduction to the wall is not included and would affect the temperature of the water. The pressure loss on the water side of the ISEC system has been assumed to be 0.5 bar. Lower or higher pressure loss would change the optimum numbers of circulations of water. A lower pressure loss would allow for a higher COP with increased number of circulations while a higher pressure loss would give a lower COP and a decrease in optimal number of circulations. The investment needed for the ISEC system compared to the conventional system is higher as more components are needed and the energy efficiency would benefit from a larger condenser. A cost-benefit analysis should be done in order to find the minimum capacity and temperature differences which are needed for ISEC to be beneficial compared to the conventional system. There has not been made any testing of the systems yet, but the test stand is under construction and tests will be carried out. The possibility to connect heat sources and heat sinks without simultaneity between heat consumption and heat demand increases the potential for heat recovery and thus increases the implementation possibilities of the ISEC based heat pumps in a flexible electricity system significantly and hereby promotes the transition to the future necessary Smart Grid energy system and to meet energy policy objectives.



## 5. CONCLUSION

The ISEC system has been designed to reduce energy consumption for producing hot water for industrial processes. The ISEC system charges the water using two storage tanks. One tank is charged while the other is discharged. The charging tank is charged by recirculating the water multiple times through the condenser with a higher mass flow rate than for a conventional heat pump. When the tank used for the industrial process is discharged the charged tank is ready to be used. A conventional heat pump heats the water in one step by passing the condenser only once. The COP of the ISEC system is potentially higher than for the conventional design. The case results show up to 25 % improvement, when the refrigerant is not subcooled. It is shown that there is an optimum of number of times the water should be recirculated through the condenser before the increase in pumping power becomes too large and the COP of the system decreases with increasing number of circulation. Increasing the size of the condenser increases the COP. The calculations are based on optimization of performance, whereas cost has not been analysed. This may give another optimum configuration. When increasing the evaporator temperature, the COP of both the conventional and the ISEC system increases. This is expected as the pressure ratio across the compressor decreases, but the increase of COP is highest for the ISEC concept. The ISEC concept has proven theoretically to be of interest for heating water with energy savings of up to 17 % considering subcooling for both systems.

## ACKNOWLEDGEMENTS

This research project is financially funded by EUDP (Energy Technology Development and Demonstration). Project title: Highly efficient Thermodynamic Cycle with Isolated System Energy Charging (ISEC), project number: 64013-0110. The project is carried out in cooperation with Danish Technological Institute who is the project manager and the industrial cooperating partners: Svedan, Innotek, Alfa Laval, Arla Foods, Bjerringbro Varmeværk and Metro Therm.

## REFERENCES

1. M. F. Olesen, C. Madsen, L. Olesen, B. Paaske and E. Rothuizen, "High efficient ammonia heat pump system for industrial process water using the ISEC concept - Part II," in *11th IIR - Gustav Lorentzen Conference*, Hangzhou, China, 2014.
2. The Danish Society of Engineers IDA, *The Ida climate plan 2050*, Copenhagen: The Danish Society of Engineers, 2009.
3. H. Becker, A. Vuillermoz and F. Maréchal, "Heat pump integration in cheese factory," *Applied Thermal Engineering*, 2011.
4. E. Zvingilaite, T. Ommen, B. Elmegaard and M. Franck, "Low temperature district heating consumer unit with micro heat pump for domestic hot water preparation," in *International Symposium on District Heating and Cooling*, Copenhagen, 2012.
5. T. Ommen, W. B. Markussen and B. Elmegaard, "Comparison of linear, mixed integer and non-linear programming methods in energy system dispatch modelling," *Energy*, 2014.
6. T. Ommen, J. K. Jensen, W. B. Markussen and B. Elmegaard, "Technical and economic working domains of industrial heat pumps 1: Vapour compression heat pumps," in *11th IIR - Gustav Lorentzen Conference*, Hangzhou, China, 2014.
7. K. Wang, F. Cao, W. Shouguo and Z. Xing, Investigation of the performance of a high-temperature heat pump using parallel cycles with serial heating on the water side, *International journal of refrigeration*, 2010.
8. F. Incropera, D. DeWitt, T. Bergman and A. Lavine, *Introduction to heat transfer*, 5th edition ed., Hoboken: John Wiley and Sons, 2007.
9. H. Martin, "A theoretical approach to predict the performance of chevron-type plate heat exchangers," *Chemical Engineering and Processing*, vol. 35, pp. 301-310, 1996.
10. Y.-Y. Yan, H. C. Lio and T. F. Lin, "Condensation heat transfer and pressure drop of refrigerant R-134a in plate heat exchanger," *Int. J. Heat and Mass Transfer*, vol. 42, pp. 993-1006, 1999.
11. E. Rothuizen, *Hydrogen fuelling stations - Thermodynamic analysis of fuelling hydrogen vehicles for personal transportation*, 1 ed., Kgs. Lyngby: Rosendahls - Schultz Grafis A/S, 2013.