



Fully Documented Fishery onboard gillnet vessels >15 m

Kindt-Larsen, Lotte; Larsen, Finn; Stage, Bjarne; Dalskov, Jørgen

Publication date:
2012

Document Version
Publisher's PDF, also known as Version of record

[Link back to DTU Orbit](#)

Citation (APA):

Kindt-Larsen, L., Larsen, F., Stage, B., & Dalskov, J. (2012). *Fully Documented Fishery onboard gillnet vessels >15 m*. DTU Aqua. <http://www.fvm.dk/Admin/.../DWSDownload.aspx?>

General rights

Copyright and moral rights for the publications made accessible in the public portal are retained by the authors and/or other copyright owners and it is a condition of accessing publications that users recognise and abide by the legal requirements associated with these rights.

- Users may download and print one copy of any publication from the public portal for the purpose of private study or research.
- You may not further distribute the material or use it for any profit-making activity or commercial gain
- You may freely distribute the URL identifying the publication in the public portal

If you believe that this document breaches copyright please contact us providing details, and we will remove access to the work immediately and investigate your claim.

FINAL REPORT

Fully Documented Fishery onboard gillnet vessels <15 m

by

Lotte Kindt-Larsen, Finn Larsen, Bjarne Stage, Jørgen Dalskov

National Institute of Aquatic Resources

Technical University of Denmark

February 2012



Denmark and The EU invest in sustainable fishing.

The Project is supported by the Ministry of Food, Agriculture and Fisheries and The EU

Ministry of Food,
Agriculture and
Fisheries



The European
Fisheries
Fund

1	INTRODUCTION	3
2	METHODOLOGY	3
2.1	Participating vessels	3
2.2	EM System and setup	5
2.3	EM Data Interpretation	6
2.3.1	Sensor Data Analysis.....	6
2.3.2	Image Data Interpretation.....	6
2.4	Skippers' logbooks	7
3	RESULTS	7
3.1	Data collection	7
3.2	Catch data analyses.....	9
3.2.1	Estimating discard of cod.....	9
3.2.2	Discard comparison.....	10
3.3	Landings data analyses	10
3.4	Bycatch of marine mammals.....	12
3.5	Bycatch of seabirds.....	13
3.6	A comparison of methods for analysing video recordings to determine marine mammal bycatch in gillnet fisheries.....	13
3.6.1	Requirements for analysis of video recordings.....	14
3.6.2	Methods for analysis of video recordings.....	14
4	DISCUSSION	21
4.1	EM system - hardware.....	21
4.2	Data collection	21
4.3	Catch data analysis	22
4.4	Landings data analysis.....	22
4.5	Bycatch of marine mammals.....	22
4.6	Bycatch of seabirds.....	23
4.7	Analysing video recordings to determine marine mammal bycatch	23
5	CONCLUSIONS AND RECOMMENDATIONS	23
6	ACKNOWLEDGEMENTS.....	25
7	REFERENCES	25
	Annex A.....	26

1 INTRODUCTION

In 2008-2009 the Technical University of Denmark's National Institute of Aquatic Resources (DTU Aqua) carried out a field trial testing whether a fully documented fishery using electronic monitoring (EM) could be a new tool for managing Danish commercial fisheries, *i.e.* allowing a paradigm shift from a system based on landing quotas to a system based on catch quotas (Kindt-Larsen *et al.*, 2011).

The study was based on a proposal from the Danish government for a new EU Common Fisheries Policy where TAC and quotas remain the primary tools. However, the individual fishermen would be accountable for their total catch, and not only the quantities landed at port. This requires that discards as well as landings are routinely recorded and can be subtracted from the quotas. The study was a major success and catch quotas based on a fully documented fishery has since 2011 been an option for Danish fishermen.

The experience gained from the 2008-2009 trial led DTU Aqua to initiate a new project testing how the EM and a catch quota system would function onboard small gillnet vessels, *i.e.* vessels with an overall length less than 15 m. This project ran from November 2009 to October 2011.

The objectives of the project were:





- To test whether electronic monitoring can be used to provide reliable documentation of the fishing operation and the catches onboard gillnet vessels less than 15 m in length.
- To demonstrate that a fully documented fishery can ensure:
 - that total catches - landings and discard – are recorded,
 - that a vessel self-sampling system provides data useful in the scientific assessment of the fisheries and the stocks,
 - an improved economy for participating vessels,
 - a documentation that can be used in evaluating the sustainability of the fishery,
 - a reliable documentation of bycatch of marine mammals and seabirds.

2 METHODOLOGY

2.1 Participating vessels

In April 2010 DTU Aqua solicited gillnet fishing vessels to participate in the pilot project. Among the total number of volunteering vessels 6 vessels were selected. They were H 356 "Flid", HG 5 "Tommy Kristine", HG 7 "Niels Jensen", HG 99 "Line Dalsgård", K 148 "Jamik" and S 530 "Yokotani". The vessels began fishing with the EM systems installed in May 2010. Data on the participating vessels are given below:

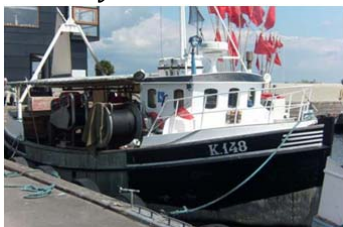
<p>H 356 Flid</p> 	<p>Home port: Sletten Vessel type: Gillnetter Building year: 2005 Length over all: 10.3 m BT: 10.7 Engine: 105 kW Power: 24 AC</p>
--	--

<p>HG 5 Tommy Kristine</p> 	<p>Home port: Hirtshals Vessel type: Gillnetter Building year: 1998 Length over all: 11.99 m BT: 7.7 Engine: 171 kW Power: 220 AC</p>
<p>HG 7 Niels Jensen</p> 	<p>Home port: Hirtshals Vessel type: Gillnetter Building year: 2002 Length over all: 14.06 m BT: 21 Engine: 140 kW Power: 220 AC</p>
<p>HG 99 Line Dalsgård</p> 	<p>Home port: Hirtshals Vessel type: Gillnetter Building year: 1965 Length over all: 12.4 m BT: 15.8 Engine: 93 kW Power: 220 AC</p>
<p>K 148 Jamik</p> 	<p>Home port: Vedbæk Vessel type: Gillnetter Building year: 1974 Length over all: 11.05 m BT: 9.8 Engine: 74 kW Power: 220 AC</p>
<p>S 530 Yokotani</p> 	<p>Home port: Skagen Vessel type: Gillnetter Building year: 1987 Length over all: 14.39 m BT: 17.3 Engine: 80 kW Power: 220 AC</p>

2.2 EM System and setup

The EM system used was the same as the one used in the Danish trials in 2008-2009 (Dalskov & Kindt-Larsen, 2009). It comprised a GPS (Global Positioning System) receiver, a hydraulic pressure transducer and up to four waterproof armoured dome closed circuit television (CCTV) cameras providing an overhead view of the working deck, close views of the fish handling areas, discard chute areas and net hauling site. Sensors and cameras were connected to a control box located in the wheelhouse. The control box consisted of a computer that monitored sensor status and activated image recording (500GB replaceable hard disk).

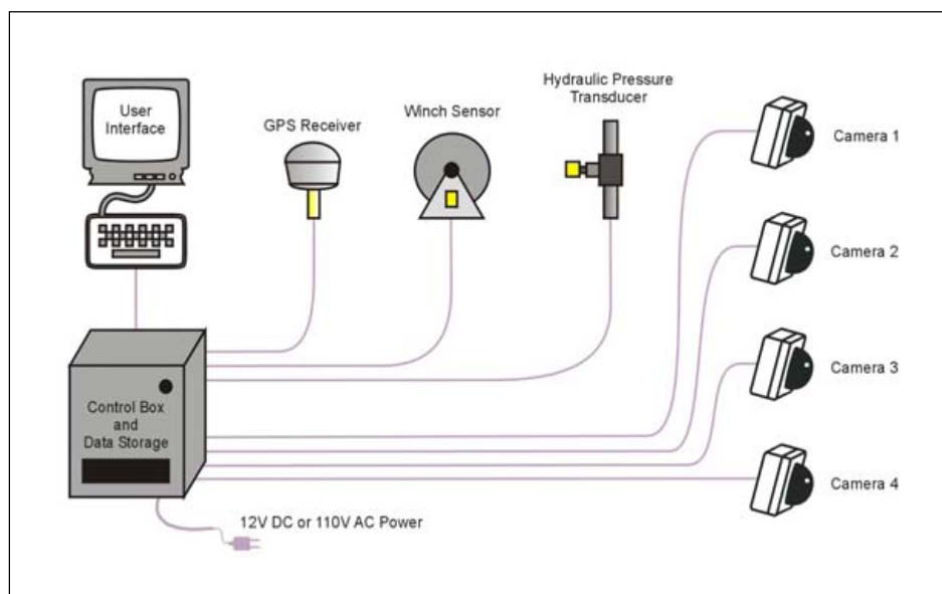

Figure 1. Schematic diagram of the remote EM system (Archipelago Ltd.).

The GPS receiver was mounted in the vessel rigging or on top of the wheel house and the electronic pressure transducer was installed in-line with the hydraulic system of each vessel. Cameras were mounted in areas that required minimum fabrication while obtaining unobstructed views of catch handling/hauling and the discard chute areas. On each vessel, every effort was made to mount cameras and sensors in the best possible location.

EM sensor data (GPS and hydraulic) were recorded continuously for the entire fishing trip (port to port). Image recording occurred from the beginning of the first haul until the vessel returned to port. All imagery included text overlay with vessel name, date, time and position. Sensor data were recorded at a frequency of once every 10 seconds and video footage was recorded with 2-7 frames per second depending on position.

During the installation the skipper was consulted regarding positioning of equipment and cabling, and onboard electrical and hydraulic systems were assessed for optimal sensor placement, power requirements and general EM system integration. At the completion of each installation, the EM technician powered the system and tested its components to ensure functionality. EM system performance has been monitored through regular servicing by DTU Aqua technicians.

Staff from DTU Aqua were regularly in contact with the skippers in order to ensure their focus, monitor the performance of the EM systems and to change hard disks. When a hard disc drive was at app. 80% capacity used, the disc was exchanged with a new hard drive.

2.3 EM Data Interpretation

The EM hard disc drives were collected by DTU Aqua staff for data storage and interpretation. Both sensor and image data were interpreted.

2.3.1 Sensor Data Analysis

All sensor data was interpreted by DTU Aqua staff by use of the EMI (Europe release) software developed by Archipelago Ltd. The purpose of sensor data (GPS and hydraulic) interpretation was to determine the spatial and temporal parameters for start and end of each fishing trip and each fishing event. The key vessel activities including transit, start and end of hauls were all identified. An example of the sensor data is given in Figure 2.

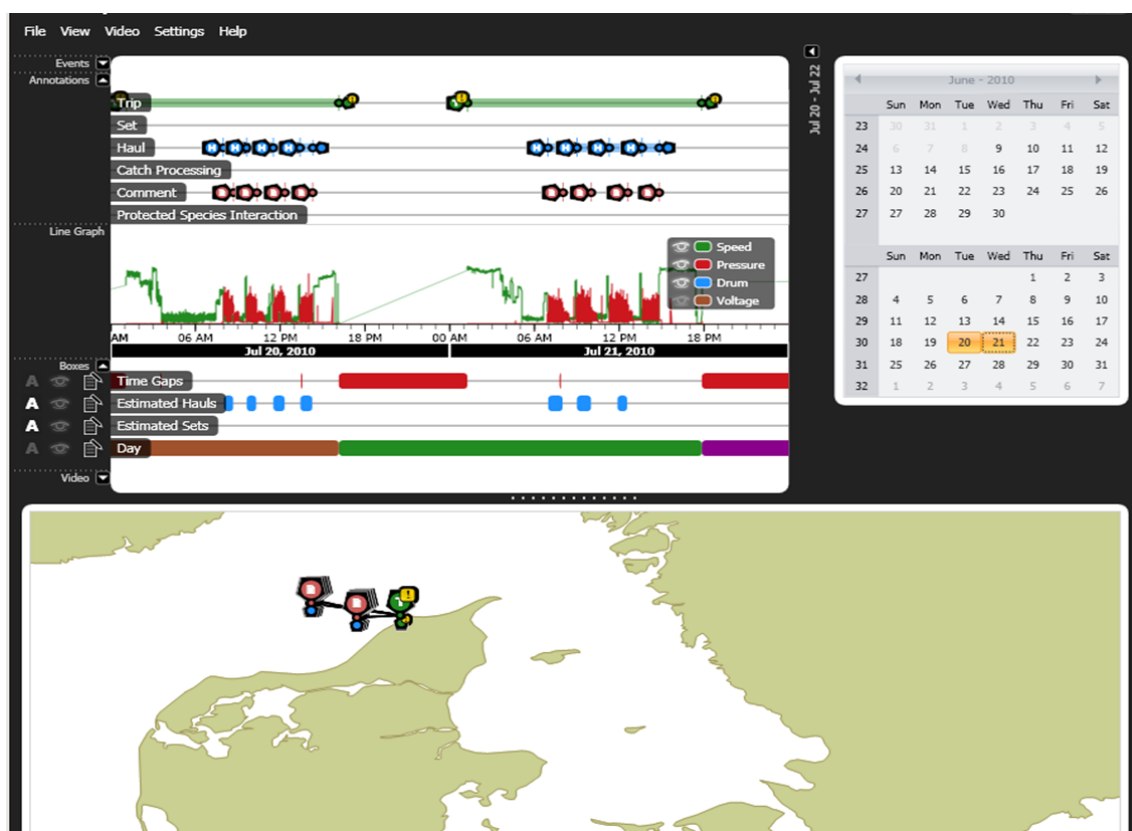

Figure 2. Screen shot of sensor data analysis.

2.3.2 Image Data Interpretation

All video footage was analysed by DTU Aqua staff by use of the EMI (Europe release) software. The software provided synchronized playback of all camera views although usually one camera view was used for catch/bycatch determinations. The speed of image playback varied depending on catch mixture and image quality.

All video recordings of net hauls were examined for bycatches of marine mammals. For this, the videos were played back at a rate 10-12 times faster than real time, since marine mammals were easy to spot even at this speed. Approximately every 10th haul was analysed for discard of cod and bycatch of seabirds. For this purpose, the video footage was normally played back at a rate 4-6 times faster than real time. However during bad weather conditions or glare in the video lenses the speed was in both cases reduced.

The fish discard video data were processed by dividing the discard into 2 different categories; cod and other species. After each catch handling session the estimated weight of the two species group categories was noted in 9 different weight intervals: 0-5kg, 5-10kg, 10-20kg, 20-50kg, 50-100kg, 100-250kg, 250-500kg, 500-1000kg and >1000kg. Before the data processing was initiated a small workshop was held to make sure that all DTU Aqua staff were estimating the discard correctly and in a uniform way. To help estimation of cod discard, it was decided that a cod just below the minimum size weighed 0.35 kg. This was based on information from fishermen and DTU Aqua staff.

In general, the quality of the video imagery has been very high (see Figure 3). Only rarely was the quality medium to low due to greasy lens covers or water on the lens cover after cleaning up the deck. Weather, light conditions or other factors that can have an effect on the video quality has not been a problem during the trial.

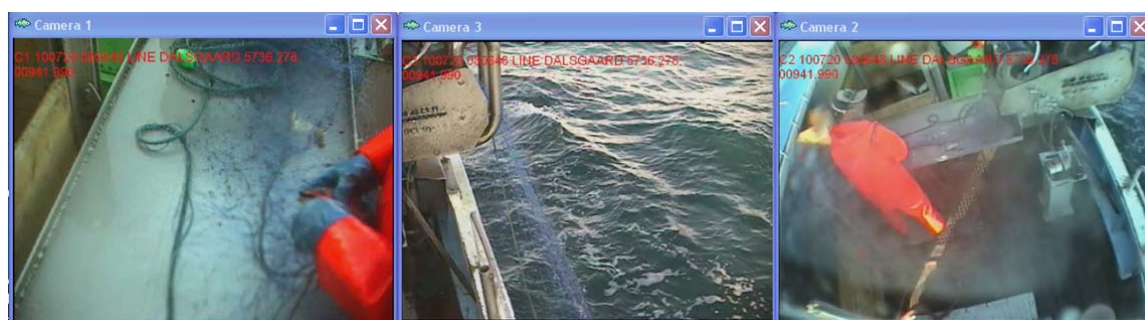

Figure 3. Example of EM video snapshots from one of the participating gillnetters.

2.4 Skippers' logbooks

The skippers on the six vessels were requested to report additional information in addition to the official logbook requirements. For each individual fishing operation the following information was requested: Date, time and position of the net sets, soak time, mesh size, number of nets, total catch in weight, weight of retained part of the catch by species, total weight of discarded cod, weight of discard of other species and the number of bycaught marine mammals.

3 RESULTS

3.1 Data collection

According to the official logbooks the 6 vessels have in the project period been at sea for 10,055 hours during 925 fishing trips. Data for individual vessels are presented in Table 1.

Table 1. Number of hours at sea and number of fishing trips per trial vessel for the project period May 2010 – April 2011 according to the official logbooks.

Vessel	No. of hours at sea	No. of trips
1	1,373	226
2	1,270	92
3	2,060	106
4	1,574	110
5	1,872	276
6	1,906	139
Total	10,055	925

Data from the skippers' extended logbooks showed that the vessels had been at sea for 771 fishing trips and conducting 1,074 fishing operations. Data for individual fishing vessels are presented in Table 2.

Table 2. Number of trips and fishing operations carried out during the trial period according to the extended logbook records made by the skippers.

Vessel	No. of trips	No. of hauls
1	179	217
2	91	91
3	96	292
4	100	103
5	171	237
6	134	134
Total	771	1,074

Sensor data and images have been collected throughout the project period. Table 3 below shows the number of trips and hauls recorded by the sensors.

Table 3. Number of trips and number of fishing operations recorded using sensor data.

Vessel	No. of trips	No. of hauls
1	125	667
2	89	727
3	67	600
4	99	780
5	253	1,532
6	178	790
Total	811	5,096

Comparing the number of fishing trips recorded by the official logbooks, the skippers' logbooks and the sensor system (Figure 4) shows that for all vessels, the number of trips recorded by the skippers' logbook is smaller than the number recorded by the official logbook.

For 5 of the vessels the number of trips recorded by the sensor data is smaller than the number recorded by the official logbooks, but for 3 of these the difference is insignificant.

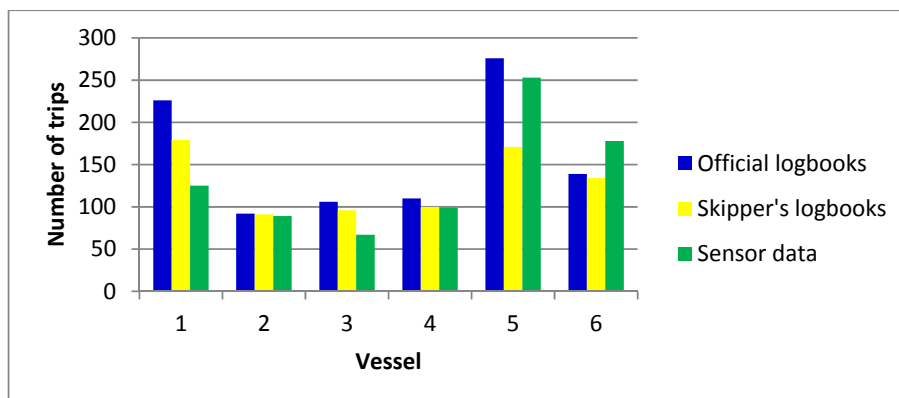

Figure 4. Comparison of the number of fishing trips recorded by the official logbooks, the skipper’s logbooks and the sensor system.

A similar pattern is seen in Table 4, which shows the number of hours of sensor data collected, the hours at sea from the official logbooks for the same period and the sensor hours as a percentage of the official logbook hours. The percentage sensor data coverage varies from 61 to 97 (excluding vessel 6) with a mean of 84% (again excluding vessel 6).

Table 4. Sensor data collected in number of hours.

Vessel	Hours at sea from official logbooks	Hours of sensor data collected	% coverage
1	1,373	833	61
2	1,270	1,215	96
3	2,060	1,613	78
4	1,574	1,358	86
5	1,872	1,812	97
6	1,906	2,625	138
Total	8,149	6,831	84

The number of hauls recorded in the sensor data is considerably larger for all vessels than the number recorded in the skippers’ logbooks. There is some variability between vessels but on average almost 5 times more hauls are recorded by the sensors than in the skippers’ logbooks.

3.2 Catch data analyses

3.2.1 Estimating discard of cod

One of the purposes of this project was to examine whether it was possible to estimate the amount of cod discarded by viewing the image records of the catch handling onboard the trial vessels.

Table 5 shows the percentage of fishing operations where the image viewer either had estimated more, the same amount or less discard of cod as the fishermen. It is clear from the table that there is a large variation between vessels in the agreement between fishermen and viewers. The viewers estimate more discard than the fishermen in between 31 % and 86 % of hauls. In between 0 % and 61 % of hauls the viewer and the fishermen estimated the same amount of cod discard, whereas in between 7 % and 44 % of the hauls the image viewer estimated a smaller discard amount than the fishermen. Looking at the overall pattern 54 % of hauls had the viewer estimating more discard than the fisher-

men, in 20 % of hauls they estimated the same amount, and in 26 % the viewer estimated less than the fishermen.

Table 5. The percentage of fishing trips where the image viewer either estimated more discarded cod, the same amount or less than the fishermen.

Vessel	Viewer > Fisher	Viewer = Fisher	Viewer < Fisher	Total no. of trips
1	63%	0%	37%	8
2	56%	22%	22%	9
3	31%	61%	8%	13
4	40%	20%	40%	10
5	50%	6%	44%	18
6	86%	7%	7%	14
All	54%	20%	26%	72

3.2.2 Discard comparison

With full catch documentation required of participating vessels, the proportion of cod retained and discarded can be estimated from skippers' catch estimates. Table 6 shows the percentage of cod that has been discarded or has been retained onboard and landed, respectively.

Table 6. The percentage of cod that has been discarded and has been retained onboard and landed using skippers' catch estimates for each vessel.

Vessel	Skippers' estimates		Viewers' estimates	
	Discarded	Retained	Discarded	Retained
1	4.8	95.2	7.0	93.0
2	0.6	99.4	0.8	99.2
3	0.1	99.9	0.1	99.9
4	0.3	99.7	0.3	99.7
5	2.8	97.2	1.0	99.0
6	1.5	98.5	5.3	94.7
All	1.5	98.5	1.9	98.1

These discard rates can be compared with discard rates estimated by the standard observer programme for the last 3 quarters of 2010. The estimate of cod discards relative to total catch of cod for the Danish fishermen using gillnet fishing in the North Sea and Skagerrak was 0.8 % (Danish Data Collection Framework Programme 2010). There is insufficient data to estimate this for Øresund.

3.3 Landings data analyses

One of the conditions for vessel participation in the project was to retain all fish above the minimum landing size. For most species the price per kg increases with fish size and it is possible for a vessel to optimise the value of a quota by only retaining large fish and discarding small ones. This type of discard is commonly called high grading and often occurs for species and areas where catch opportunities and quotas do not match.

To investigate whether this high grading of cod is occurring on a regular basis, comparisons of size distributions between the trial vessels and the rest of the fleet fishing in the same areas were made (see Annex A, Tables I-IV). Four of the trial vessels have been fishing in the North Sea and Skagerrak (Annex A, Table I) and two in Øresund (Annex A, Table III). Figures 5-6 show the proportion of cod per size grade for each month in the period May 2010 - April 2011 for the trial vessels that have landed

cod caught in the North Sea/Skagerrak and in Øresund, compared to similar distributions for all Danish gillnet vessels (trial vessels excluded) in the same areas and months. Size grade 1 are the large fish and 5 are the small ones.

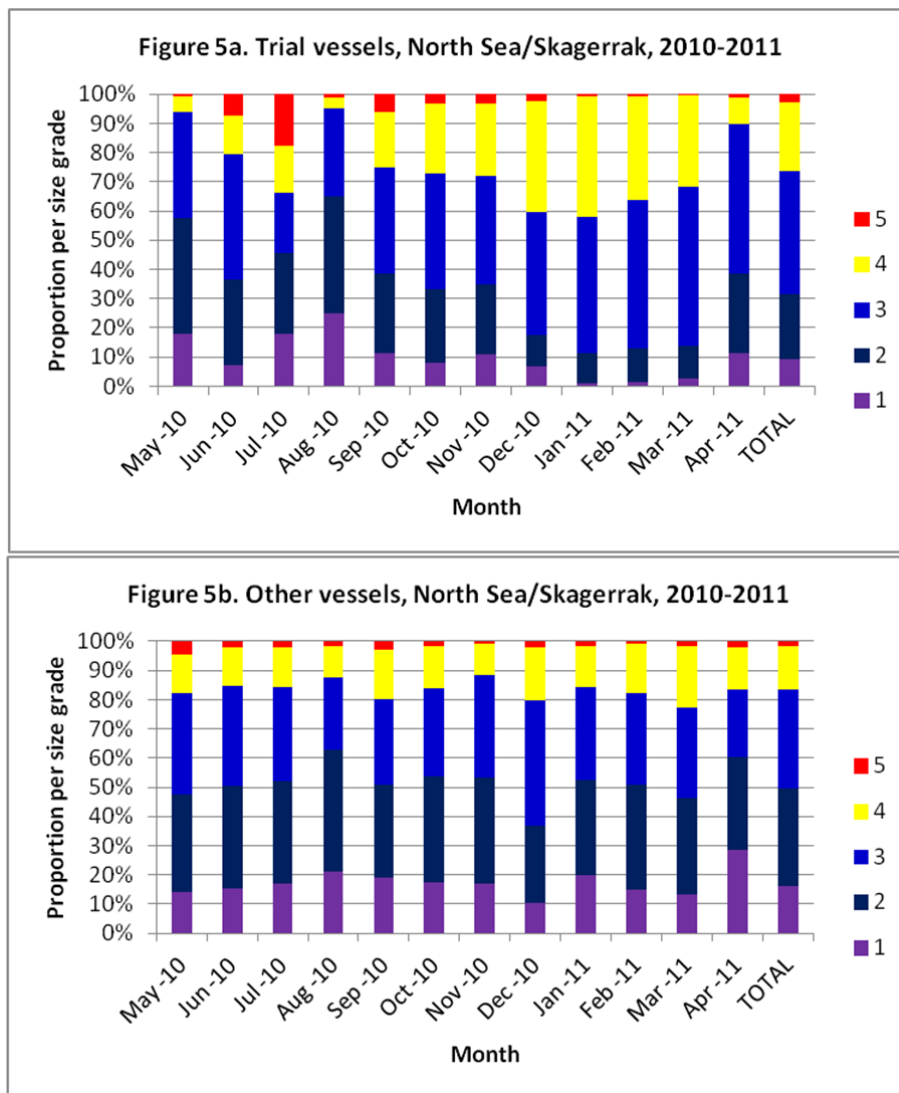

Figure 5. The proportion of cod per size grade for each month in the period May 2010 - April 2011 for vessels landing cod caught in the North Sea and Skagerrak. Figure 5a: trial vessels; Figure 5b: all other gillnet vessels.

The size grade landing pattern for the trial vessels fishing in the North Sea and Skagerrak (Figure 5a) varies somewhat between months, while it is more uniform for the other vessels fishing in this area (Figure 5b). Comparing Figures 5a and 5b suggest that some high grading may be occurring on the vessels that did not have EM on board, but the difference between the totals is probably not statistically significant.

The size grade landing pattern for the vessels fishing in Øresund (Figure 6) is quite variable from month to month, but the landing pattern appears to vary in the same way when comparing the trial

vessels to the other vessels fishing in this area. However, there is no suggestion that high grading is occurring to any significant extent.

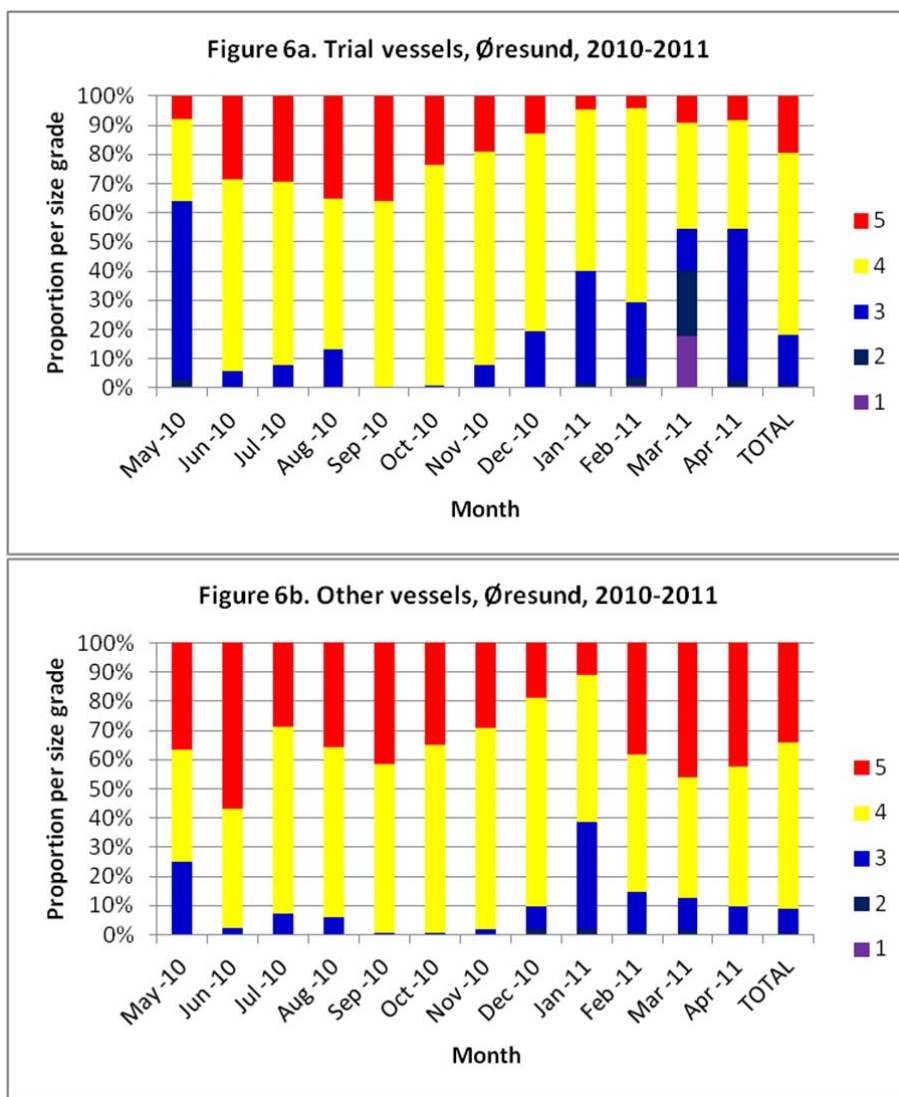

Figure 6. The proportion of cod per size grade for each month in the period May 2010 - April 2011 for vessels landing cod caught in Øresund. Figure 6a: trial vessels; Figure 6b: all other gillnet vessels.

3.4 Bycatch of marine mammals

Data on bycatch of marine mammals came from two sources. One was the skipper's logbooks, where the skippers were asked to record information on all bycatches of marine mammals. The other source was the video images, from which bycatch information was recorded during the video analyses. Table 7 presents harbour porpoise bycatch data from these two sources for hauls where data from both sources were available. A total of 22 porpoises were both recorded in the logbooks and seen on the videos, 3 porpoises were recorded in the logbooks but not seen on the videos and 14 porpoises were seen on the videos but not recorded in the logbooks. In addition 6 porpoises were seen on videos

during trips where logbooks were not available. Fourteen of the 39 porpoises were observed by the video viewers but not recorded in the skippers' logbooks. This means that the logbooks recorded 25 of 39 porpoises (64 %), whereas the video system recorded 36 of 39 porpoise, equivalent to 92 %. Inspection of the videos revealed that 7 of the 14 porpoises not recorded in the skippers' logbooks fell out of the nets before they were seen by the fishermen.

One harbour seal was observed as bycatch during the video analyses, but was not recorded in the skipper's logbook.

Table 7. Number of harbour porpoises bycaught. Data from fishermen's logbooks and video analyses for hauls where data from both sources were available. "Seen" and "Not seen" refers to whether the fishermen saw the porpoise bycatch or not.

Vessel	Logbook and video	Logbook only	Video only		Total
			Seen	Not seen	
1	1	1	0	0	2
2	1	0	3	1	5
3	0	0	1	0	1
4	6	0	2	0	8
5	3	2	0	0	5
6	11	0	1	6	18
Total	22	3	7	7	39

3.5 Bycatch of seabirds

Data on bycatch of seabirds came from the video images only and only every 10th trip has been analysed. The video analyses recorded 25 birds bycaught (Table 8). Of these, 18 were guillemot, 2 were cormorants, 2 were gulls and 3 were unidentified. The gulls were alive and subsequently released.

Table 8. Number of birds bycaught from video analyses of every 10th trip. Data for guillemots are shown for each of the three areas North Sea (IV), Skagerrak (IIIan) and Øresund (IIIb). A hyphen means that the vessel did not fish in that specific area.

Vessel	Guillemot			Cormorants	Gulls	Unknown	Total
	IV	IIIan	IIIb				
1	-	-	0	0	0	0	0
2	-	0	-	0	0	1	1
3	0	0	-	0	0	0	0
4	-	1	-	0	0	0	1
5	-	-	15	2	2	2	21
6	1	1	-	0	0	0	2
Total	1	2	15	2	2	3	25

3.6 A comparison of methods for analysing video recordings to determine marine mammal bycatch in gillnet fisheries

Monitoring of marine mammal bycatch by observer programs has been conducted in EU waters for a number of years due to growing concern about the population status of many marine mammal popu-

lations (ICES, 2010). Observer programs are, however, very expensive and very often difficult to implement. Since the implementation of EU Council Resolution 812/2004 approximately 6 million EUR have been spent on marine mammal observer programs in EU waters, under which 135 cetacean bycatches have been recorded. Many other observer schemes have, however, often been integrated with the marine mammal observer programs (Anon., 2010).

Since the EM system records all hauls, it is also possible to verify the bycatch of marine mammals. If video footage is to be used for routine monitoring of marine mammal bycatch in Danish waters, it is very important to find the best possible method to determine the number of animals caught. An important objective of the study was therefore to evaluate the feasibility of using computer aided techniques to detect the presence of marine mammal bycatch.

The purpose of this section is thus to provide an overview of the possibilities for solving the data analysis task. First the requirements for the analysis task are formulated followed by a discussion of the technical and physical limitations posed by the problem. Next a number of solutions are discussed in relation to the requirements and the limitations. Finally the possible solutions are compared and recommendations for future activities are suggested.

3.6.1 Requirements for analysis of video recordings

The purpose of this section is to formulate a number of requirements for a system for analysis of video recordings that covers all important aspects of the system.

Acquisition Cost

Commercial Off The Shelf (COTS) systems typically have a lower acquisition cost than tailor made systems. An example of a COTS system is the system from Archipelago Ltd. Such systems are developed for a global market and many customers share the development costs. Development of tailor made systems is costly and risky. The development cost increases very rapidly with the complexity of the system.

Operating Cost

Operating cost includes expenses for staff and licenses to cover software maintenance.

Performance

System performance here is defined here as the probability of spotting the presence of a marine mammal in a video recording.

Uniformity

The result of the analysis process must be uniform. All possible error sources in the process must be kept under control to keep the performance of the system at a high and constant level.

3.6.2 Methods for analysis of video recordings

The purpose of this section is to provide an overview of the possibilities and limitations for design of systems for analysis video sequences and to make a comparison of five systems.

The video recordings from the EM system consist of sequences of colour images with a resolution of 640 x 480 pixels. The frame rate can be adjusted in connection with the acquisition. In the data used in this context the frame rate was set to 2 Hz. The images are usually clear with good contrast (see Figure 7), but occasionally dew and water droplets appear on the lens. The images typically contain a background of water with waves together various objects such as fishermen, nets, birds, fish and marine mammals. The lighting of the images varies with the position of the sun, clouds and haze. Also, shadows from the fishing vessel are present in the images depending on the vessel orientation relative to

the sun. The cameras are mounted differently on different fishing vessels, thus introducing additional variability. Overall, these video data are very complex and variable.



Figure 7. Examples of image frames from video data.

The process for spotting marine mammals in a video recording is illustrated in Figure 8. The image content is created by a combination of lighting conditions and the objects located in the camera's field of view. The image can be divided into segments, or image elements corresponding to the different objects present, provided that these objects can be distinguished from each other by colour, contrast, or direction and speed of motion. In the final step each of these image segments must be recognized. Recognition implies that an object is already known. It is therefore, necessary for both humans and computers to have *a priori* knowledge of the objects that can appear in images to recognize them.

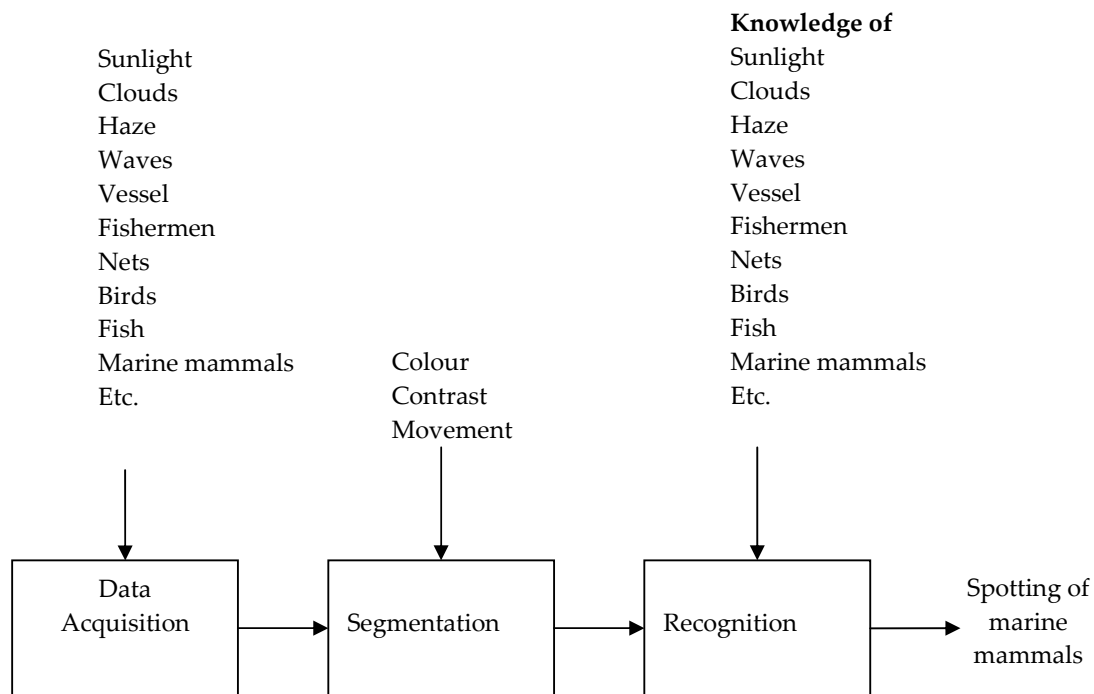

Figure 8. Data flow diagram for the process of spotting marine mammals.

To recognize an object, the representation of the object in the image must have a certain size. According to the Johnson criteria (Johnson, 1958) a human observer requires, on the average, 8 pixels on the narrowest dimension of the object in an image with good contrast to complete the recognition task sufficiently. This, of course, varies with the type of object and the experience of the observer. Usually, a standard deviation of 1.6 pixels is assumed. The upper limit for a 95% confidence interval for detection is therefore, about 12 pixels. This is a minimum, as more pixels are required in images with poor contrast, noise and complex background. Recognition performed by a computer is not as effective as a trained observer, so in this case additional pixels are required.

The probability of spotting an object in an image and subsequently perform recognition depends on the time available for an observer to perform the task (Kopeika, 1998). Usually, this is modelled as an exponential saturation process as illustrated in Figure 9.

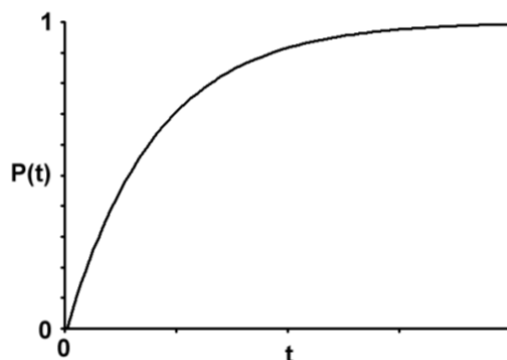

Figure 9. Correlation between time available to an observer and the probability of spotting and recognizing an object in an image.

The details of this curve depend on object size, contrast, etc. Video sequences are normally played back with constant frame rate, which means that the probability of recognition in principle fluctuates uncontrollably with image content. If an object is to be recognized with the same probability in all images of a video sequence, it must be played back with a frame rate that depends on image content and is controlled by the operator.

In the following, characteristics of the systems studied are described.

System 1. The Archipelago system

In the system from Archipelago (see Figure 1), video can be played back in full resolution. The amount of video data to be viewed can be restricted to periods where the net is being hauled, thus significantly reducing the time for analysis of data.

Acquisition cost is low because it is a COTS system. The operating cost must be considered high as it takes an operator considerable time to review the video sequences. Performance is considered good as marine mammal size measured pixels in the images are significantly larger than the Johnson criterion and the objects appear in successive video frames, so the time required for recognition should not be a problem. The uniformity can be achieved by random sampling.

System 2. The Archipelago system x 12

This system is identical to System 1, except that the video data are played back with a frame rate 12 times larger than the recording frame rate.

Acquisition cost is low because it is a COTS system. Operating cost is approximately 12 times lower than System 1. Performance is worse than System 1, because video frames with marine mammals can be missed. Further, the short time a marine mammal is visible in the video decreases performance. The system has been used for a period of 6 months in which no missed detections have been noted. The uniformity can be achieved by random sampling.

System 3. Image montage

This system utilizes that image elements representing marine mammals in the images are relatively large. The original video frames are reduced in size and arranged in an assembly or montage as shown in Figure 10. The operators can then browse through the video file at their own pace.

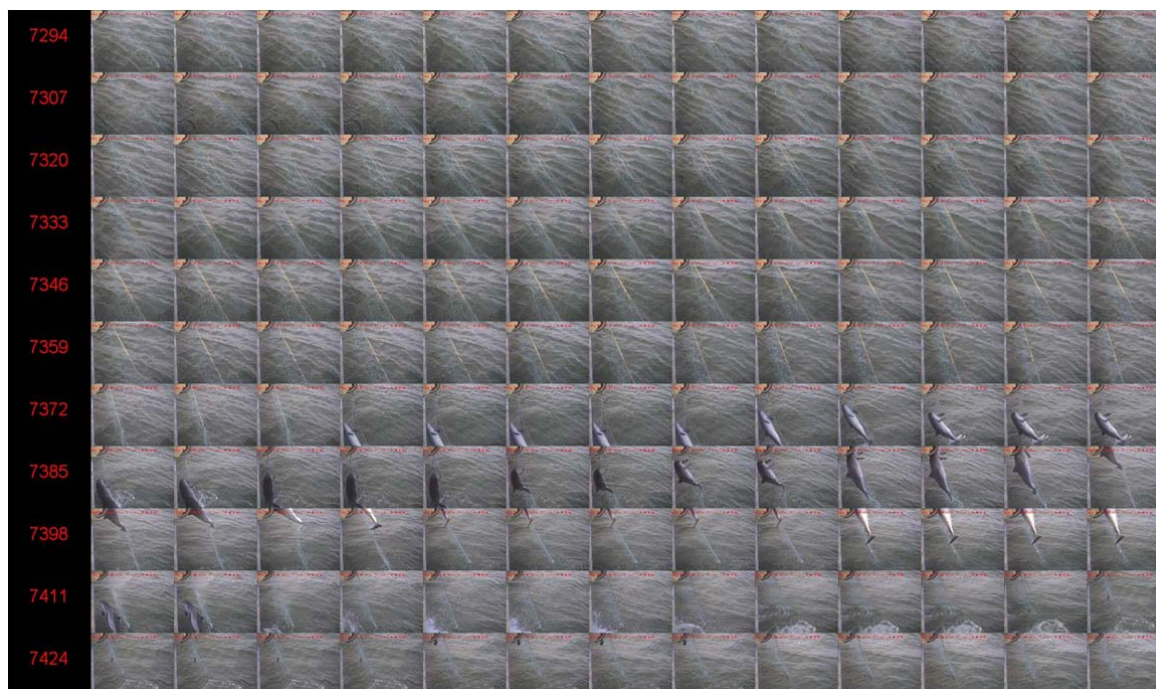

Figure 10. Image montage.

The acquisition cost will be low if this functionality is implemented in the Archipelago system. The operating cost depends on how long it takes the operator to scroll through the catalogue of montages. In this example there are $13 \times 11 = 143$ frames in each montage. With a standard video frame rate of 25 Hz it takes approximately 6 seconds to view 143 frames and approximately 0.5 seconds at x 12 speed. It is estimated that a montage as the one shown in Figure 10 easily can be examined with a high probability of spotting a marine mammal under less than 6 seconds, but probably not at 0.5 seconds. This gives an operation cost of System 3 midway between System 1 and System 2. Performance is very nearly equivalent to System 1, when marine mammals appear with a size larger than the Johnson criterion. The uniformity can be achieved by random sampling.

The system has been tested on 4 test subjects, each with 14 video sequences. Both with subjects who had prior experience with the Archipelago system, and subjects who had no experience with any of

the systems. In spite of, that all test subjects received the same instruction and that all test subjects were trained in the use of each of the systems with an example, a large difference in the way the test subjects browsed the catalogues was observed. Some did it relatively quickly while others were flipping the montages very slowly. Test subjects who were accustomed to the Archipelagos system did not like this method. The test subjects were missing a zoom feature to allow the small pictures to be viewed in full size. The differences in performance on the tested systems were not statistically significant.

System 4. Overlaid image montage

This system is similar to System 3; however, 15 video frames are overlaid in each image in the montage as shown in Figure 11. The overlays are produced by continuously producing a median background image based on 200 video frames. The median operation over time removes all objects from the image including waves, net and animals. By subtracting the median image from the current video frame all time varying objects will stand out from the background. All pixels with a pixel value that exceeds a threshold value and has a connected area greater than a second threshold value are declared objects. Objects from 15 frames are overlaid on the first image in the sequence. The objects that are overlaid in this way are waves of white foam, nets, birds, fish and marine mammals.



Figure 11. Overlaid image montage.

The acquisition cost will be low if this functionality is implemented in the Archipelago system. The operating cost depends on how long it takes the operator to browse through the catalogue of montages. In this example there are $13 \times 11 \times 15 = 2145$ frames. With a standard video frame rate of 25 Hz it takes approximately 85 seconds to view 2145 frames and approximately 7 seconds at $\times 12$ speed. It is estimated that a montage as the one shown in Figure 11 can easily be examined with a high probability of spotting a marine mammal in less than 7 seconds. This gives an operation cost of System 4 which is equal to or better than System 2. Performance is very nearly equivalent to System 2, when marine mammals appear with a size larger than the Johnson criterion. Thresholds might be set incorrectly so that marine mammals are not segmented correctly. It is however considered that it would be

unlikely that a marine mammal is not found in 1 of 15 frames. A real problem is if a marine mammal is found in 14 frames and the image at frame 15 includes a wave or a fisherman, which then overwrites the picture of marine mammals. This problem can be virtually eliminated by adding a zoom feature that allows the operator to play the 15 images in each of the reduced images as a video at full image resolution. The uniformity can be achieved by random sampling.

The system has been tested on the test persons similarly to System 3. The conclusions were the same as described for System 3. This was a disappointing result considering the expectations to this system. The conclusion also seems incomprehensible as 7 seconds certainly is not needed to spot a marine mammal in the upper image row in Figure 11. It is therefore believed that this system has a potential equal to expectations if implemented with a zoom function with video clips.

System 5. Automatic recognition

As illustrated in Figure 8, a system for automatic recognition must have knowledge of everything from sunlight to marine mammals in order to recognize with the same performance as a human observer. This is not achievable. Not even the shape and colour on marine mammals will be particularly useful to separate them from the surroundings as these vary with lighting conditions and orientation of the mammal. It is only the size and implicitly the weight that separates marine mammals from other objects in the video recordings. The size of a marine mammal may be difficult to determine on the basis of colour deviations from the background alone. A harbour porpoise with a black back and white belly easily appears as two objects: the black back and the white belly. It could therefore be useful to have data from a range camera that measures the distance to objects. In such a camera marine mammals will almost always appear as a single object. A further distinctive feature is the weight of mammals. The weight will often weigh down the net so marine mammals are moving more or less vertically in the image sequence. This distinguishes it from many other objects. Something large that has white-grey-black colour shades and moves vertically in the picture is almost certainly a marine mammal. Movement can be determined by tracking. Tracking requires that the image of the object does not change much from frame to frame in both the video and range images. Therefore, a higher frame rate than the present is required. In the longer term, one could imagine a real-time system that will alert the fisherman with for example a signal tone when a marine mammal is spotted in the net. There could be other systems for automatic recognition of marine mammals that use other sensors and methods. This system is simply described here to have a basis for comparison.

The acquisition cost of a system for automatic recognition will be high. In addition, the acquisition of range cameras and computing power for processing data will also be higher. If the system works as intended, the primary operating expense will be power consumption to operate computers. Performance will probably be high, especially when it is acceptable to generate false alarms in the case of waves or similar phenomena. It may be a danger that the system is set up so that marine mammals are not recorded in special situations. Computer algorithms and threshold values are uniform, but the video recordings are from an uncontrolled environment and will not be uniform. Uniformity can be improved by using adaptive algorithms to account for the changes in the environment.

The comparison in Table 9 summarizes the characteristics of the systems. The existing System 1 from Archipelago meets all requirements except for operating expenses. In order to reduce operating cost an investment must be made in terms of development. A solution similar to System 4 with an added zoom function with video clips seems to be an inexpensive alternative to System 5.

	System 1	System 2	System 3	System 4	System 5
Aquisition cost	Green	Green	Yellow	Yellow	Red
Operating cost	Red	Yellow	Yellow	Green	Green
Performance	Green	Yellow	Yellow	Green	Green
Uniformity	Green	Green	Green	Green	Green

Table 9. Qualitative comparison of fulfilment of systems requirements indicated by the colours green: good, yellow: medium and red: bad.

Recommendations

The system from Archipelago is excellent in the immediate situation, but operating costs can probably be reduced by the application of automated image processing. It is recommended to launch a research and development activity in this area in collaboration with DTU Department of Informatics and Mathematical Modelling and one or more private companies.

3.6 Comparing monitoring costs

In the present trial the 6 vessels were monitored at sea for 811 days. The costs of monitoring these 811 days at sea by the EM systems were as follows:

Systems	
6 EM systems (systems and installation)	410,000 kr.
Running costs	
Video and sensor analyses	109,560 kr.
Technical support and maintenance	20,000 kr.
Total running costs	129,560 kr.

If the 811 days had instead been monitored by onboard observers, the total cost of the monitoring would be:

811 days @ 5,000 kr./day	4,055,000 kr.
---------------------------------	----------------------

So the onboard observer monitoring is approximately 7.5 times more expensive than monitoring by the EM systems if we include the acquisition of the EM systems and more than 30 times more expensive if we include only EM running costs. This estimate does not include the costs of writing the reports, which is assumed to be the same for both methods.

4 DISCUSSION

4.1 EM system - hardware

The EM systems were deployed on six different gillnet vessels and under six different environments in terms of physical conditions like dust, temperature and humidity. Furthermore, power supplies were different between vessels and not always stable with power failures happening a number of times. Despite these conditions the EM system developed by Archipelago Ltd. was robust, reliable and worked well.

One of the objectives of the project was to test whether electronic monitoring can be used to provide reliable documentation of the fishing operations and the catches onboard gillnet vessels with a total length less than 15 m. The six gillnet vessels in the present study has total lengths of 10-14 m, and based on the experience gained from these six vessels, their size did not present any major problems for the installation or running of the EM systems. More important than the size of the vessel is the availability of points of attachment for the cameras that will permit unobstructed views of the net hauler and the deck areas where the catch is sorted. Lack of such attachment points could be a problem on vessels smaller than 10 m, and it is recommended that trials are carried out on such vessels to determine if EM systems could be used also on these vessels.

4.2 Data collection

The number of trips recorded by the skippers' logbook is smaller than the number recorded by the official logbook for all vessels. This difference may be due to a number of reasons including: i) skippers forgetting to complete the forms; ii) forms are lost on their way from the skipper to DTU Aqua; iii) forms are not legible; or iv) forms do not include the correct information. However, for most of the vessels the difference is insignificant. Better information to the skippers about the value of filling out the forms correctly and legibly, together with improved procedures for handling the forms should reduce these problems. However, it should be kept in mind that skipper logbooks are used only in these trials and are not expected to be part of a routine monitoring system.

The number of trips recorded by the sensor data is smaller than the number recorded by the official logbooks for 5 of the 6 vessels, but for 3 of these the difference is insignificant. For vessel 1 and vessel 3 the more substantial differences are due to corrupted files from the EM system leading to the loss of significant amounts of sensor data. In addition, for vessel 1 there were repeated problems with power supply and later the control box developed a fault and had to be replaced, which took some time as a new one was not readily available. However, even with this loss of data, the average sensor data coverage for vessels 1-5 was 84 %. Nevertheless, the reason for these corrupted files needs to be investigated and their occurrence reduced to an absolute minimum if EM is to be used for reliable routine monitoring. For vessel 6 the sensor data recorded substantially more trips than both the official logbook and the skipper's logbook. The reason for this is not clear, but part of the explanation is that the crew regularly used the vessel for transportation from the port of landing to their home port during weekends. The EM system logs this as fishing activity because the vessel is away from the port defined as the home port in the EM system. This in itself is not a problem as long as the sensors reliably record all fishing operations.

The number of hauls recorded in the official logbooks by gillnetters corresponds very well to the number recorded in the skippers' logbooks, whereas the sensor data records almost five times as many hauls. This is because the pressure sensor on the net hauler records each time the net hauler is

started and stopped, which is normally several times during a trip. This difference is important to be aware of if haul based data from the sampled vessels are extrapolated to the whole fleet.

4.3 Catch data analysis

One of the purposes of this project was to examine whether it was possible to estimate the amount of cod discarded by viewing the image records of the catch handling onboard the trial vessels. To evaluate this, a comparison was made between the amounts of cod discards recorded in the skippers' logbooks and the amounts estimated by the image viewers. However, interpreting these percentages is not straightforward, as the expected distribution is not known. Averaged across all 6 vessels the two parties agreed in 20 % of the trips, the viewer estimated a larger discard than the skipper in 54 % of the trips and the skipper recorded more discard than the viewer in 26 % of the trips. However, these averages hide a very large variation between vessels, with agreement varying from 0 to 61 %. In a similar study by Dalskov & Kindt-Larsen (2009), the agreement was 72 % (range: 57-90 %), the viewers estimated more than the skippers in only 9 % of the fishing events, and the skippers recorded more than the viewers in 19 % of events. Interestingly, one of the vessels participated in both studies, and scored very differently in the two studies. In the Dalskov & Kindt-Larsen study this vessel scored 62 % agreement, 5 % where the viewers estimated more than the skipper, and 33 % where the skipper recorded more than the viewers, compared to 86, 7 and 7 % in the present study. This suggests that there are some methodological issues involved, related to how the weight of the catch is recorded. These issues need to be identified and resolved if EM systems are to be used routinely for monitoring catches and discards.

In general, however, the total discard of cod was very low at 1.5–1.9 % depending on whether we use the skippers' or the viewers' estimates. In comparison the average discard percentage for cod in the North Sea and Skagerrak gillnet fishery was 0.8 % for 2010.

4.4 Landings data analysis

One of the conditions for vessel participation in the project was to retain all fish above the minimum landing size. For most species the price per kg increases with fish size and it is possible for a vessel to optimise the value of a quota by only retaining large fish and discarding small ones. This type of discard is commonly called high grading and often occurs for species and areas where catch opportunities and quotas do not match.

Comparing the size grade landing patterns for the trial vessels to the pattern of the rest of the gillnet fleet fishing in the North Sea and Skagerrak suggest that some high grading may be occurring on the vessels that did not have EM coverage, but it is questionable whether this difference is statistically significant. This is supported by the observation that in Øresund, if there is high grading occurring, it looks like it is occurring on the trial vessels, contrary to expectations. This suggests that more detailed statistical analyses are needed before any firm conclusions can be drawn on whether high grading occurs to any significant extent.

4.5 Bycatch of marine mammals

One of the objectives of the project was to determine whether electronic monitoring can provide a reliable documentation of the bycatch of marine mammals. This was assessed by comparing the records of marine mammal bycatch in the skippers' extended logbooks with the observations of marine mammal bycatch made by the video image viewers. A total of 39 harbour porpoises and 1 harbour seal were recorded by either logbooks or video and of these only 3 porpoises were recorded in the

logbooks but not seen on the video images. Fourteen of the 39 porpoises were observed by the viewers but not recorded in the skippers' logbooks. This means that the logbooks recorded 25 of 39 porpoises (64 %), whereas the video system recorded 36 of 39 porpoise, equivalent to 92 %. We conclude from this that the EM systems are documenting marine mammal bycatch reliably.

The EM system has the advantage compared to onboard observers that one of the cameras can cover the nets as they are leaving the water surface and thus record any marine mammals that may drop out of the net before being brought on board. How large this drop-out is has often been debated, but very little data exists on this. We discovered that by carefully inspecting the video sequences of porpoise bycatch, it was possible to determine if a bycaught porpoise was seen by the fishermen or not. In this way we determined that 7 of the 14 porpoises observed on the videos but not recorded in the skippers' logbooks actually dropped out of the nets before being seen by the fishermen on board. The fishermen are normally too busy removing fish and clearing nets to be able to watch the nets as they come out of the water. As a result, the bycatch observed with EM systems is closer to the actual total bycatch than records made by the fishermen and probably also closer than observations made by onboard observers, who also normally have other tasks to perform on board and are not able to watch the nets coming out of the water all the time.

4.6 Bycatch of seabirds

The skippers had not been asked to record bycatch of seabirds in their extended logbooks, so data on this came from the video images only (Table 8). A total of 25 birds were recorded as bycatch, and only 3 of these could not be identified to species level, showing that EM systems can be used to monitor seabird bycatch routinely and reliably.

The observed seabird bycatch was not evenly distributed. Most of the 6 trial vessels caught only 1 or 2 birds if any, whereas one vessel fishing in the northern Øresund caught 21 birds, of which 15 were guillemots. Of these 15 guillemots 7 were caught on the same trip in February. Since seabird bycatch was recorded for every tenth trip only, we have begun to review all the other trips for this particular vessel, to determine how this guillemot bycatch varies in time and space. The results are expected in March 2012, and will be reported separately.

4.7 Analysing video recordings to determine marine mammal bycatch

If video footage is to be used for routine monitoring of marine mammal bycatch, it is very important to find the best possible method to determine the number of animals caught. An important objective of the study was therefore to evaluate the feasibility of using computer aided techniques to detect the presence of marine mammal bycatch. Four systems were compared in tests with both experienced and inexperienced viewers, but none of the systems were considered by all the viewers to be better than the basic Archipelago system. Although the basic Archipelago system is excellent in the immediate situation, operating costs can probably be reduced by the application of automated image processing.

4.8 Comparing monitoring costs

If the 811 days at sea monitored in this trial was covered by onboard observers the cost would have been approximately 7.5 times higher than the actual cost of EM monitoring. The only major advantage of using onboard observers compared to the EM systems is that the observers can perform length measurements or other tasks while on board and bring samples of the catch ashore if needed. However, this needs not be done on every trip, but could be done less frequently as needed and in combination with EM monitoring.

5 CONCLUSIONS AND RECOMMENDATIONS

The objectives of the project were:

- To test whether electronic monitoring can be used to provide reliable documentation of the fishing operations and the catches onboard gillnet vessels less than 15 m.
- To demonstrate that a fully documented fishery can ensure:
 - that total catches - landings and discard – are recorded,
 - that a vessel self-sampling system provides data useful in the scientific assessment of the fisheries and the stocks,
 - an improved economy for participating vessels,
 - a documentation that can be used in evaluating the sustainability of the fishery,
 - a reliable documentation of bycatch of marine mammals and seabirds.

Based on the results of this project, we conclude that EM systems can be used reliably onboard fishing vessels of less than 15 m overall length, contingent on the availability of points of attachment for the cameras that will permit unobstructed views of the net leaving the water and the deck areas where the catch is sorted. Another important requirement is that the reasons for the corrupted files experienced on some of the vessels are identified and their occurrence reduced to an absolute minimum.

We also conclude that a fully documented fishery using EM systems can ensure that total catches of cod are recorded. However, this requires that the methodological issues alluded to in Section 4.3 are identified and resolved. It should be noted that this project did not attempt to assess total catches of other fish species, but doing that should not present any major problems.

We furthermore conclude, based on the results of this project, that the use of EM systems can ensure a reliable documentation of the bycatch of marine mammals and birds onboard Danish gillnet vessels. An important added advantage of the EM systems is that the observed bycatch is probably closer to the actual total bycatch than bycatch observations made by on-board observers. We also conclude that in Denmark, using EM systems for monitoring is considerably less expensive than using onboard observers.

Widespread use of EM systems will provide data that better reflects total catches than using onboard observers on a small fraction of the vessels, and in this way data from EM systems will more useful in the scientific assessment of the fisheries and the stocks. The use of EM systems will also result in an improved economy for participating vessels, partly because of the increased quota given to participating vessels, but more importantly because of the improved possibilities for certification that the full documentation will lead to through better assessments of the sustainability of the fisheries.

Based on the results and experience from this project we recommend the following:

- That EM trials are conducted on vessels below 10 m in overall length.
- That the reasons for the corrupted files experienced on some of the vessels are identified and their occurrence reduced to a minimum.
- That the methodological issues related to how the weight of the catch is recorded, alluded to in Section 4.3, are identified and resolved.
- That a research and development activity is launched on the application of automated image processing in collaboration with DTU Department of Informatics and Mathematical Modelling and one or more private companies.

6 ACKNOWLEDGEMENTS

This project was funded by the Danish Ministry for Food, Agriculture and Fisheries, Danish Food Industry Agency, and the European Union's European Fisheries Fund.

We are grateful for the cooperation and support of vessel owners, skippers and crews onboard the Danish fishing vessels H 356 "Flid", HG 5 "Tommy Kristine", HG 7 "Niels Jensen", HG 99 "Line Dalsgård", K 148 "Jamik" and S 530 "Yokotani" who carried EM equipment aboard their vessels and demonstrated interest and a significant willingness for providing feedback throughout the whole project period.

This project has been conducted without major difficulties thanks to Archipelago Marine Research Ltd. and the professionalism provided by Howard McElderry, Morgan Dyas, Maria Jose Pria, Dale McCullough and their colleagues.

Several DTU Aqua staff participated in this project including Hans Jakob Olesen, Josefine Egekvist, Kirsten Birch Håkansson, Louise Scherffenberg Lundgaard, Paula Rojas Tirado and Reinhardt Jensen. This project would not have been possible without their efforts.

7 REFERENCES

- Anonymous. 2010. Mitigation of incidental catches of cetaceans in EU waters. *European Parliament Study IP/B/PECH/IC/2009-39*, 154 pp.
- Dalskov, J. & Kindt-Larsen, L. 2009. Final Report of Fully Documented Fishery. *DTU Aqua report no. 204-2009. Charlottenlund. National Institute of Aquatic Resources, Technical University of Denmark*, 49 pp.
- ICES. 2010. Report of the Workshop to Evaluate Aspects of EC Regulation 812/2004 (WKREV812). *ICES CM 2010/ACOM:66*, 65 pp. Available at www.ICES.dk.
- Johnson, J. 1958. Analysis of Image Forming Systems. *Proc. Image Intensifier Symposium, U.S. Army Engineer Research and Development Laboratories, Fort Belvoir, Va., Oct. 6-7, 1958*.
- Kindt-Larsen, L., Kirkegaard, E. & Dalskov, J. 2011. Fully documented fishery: a tool to support catch quota management system. *ICES Journal of Marine Science*, doi:10.1093/icesjms/fsr065.
- Kopeika, N.S. 1998. A system engineering approach to imaging. *SPIE Press. ISBN 9780819423771*.

Annex A

Table I. Landed weight in kilogram by month and size grade for cod landed by the trial vessels from the North Sea and Skagerrak, May 2010 – April 2011.

<i>Trial vessels</i> NS/SK	Landed weight per size grade					Total
	1	2	3	4	5	
May 2010	2,269	5,113	4,640	657	115	12,795
June 2010	872	3,446	5,115	1,589	845	11,868
July 2010	411	639	473	367	405	2,295
August 2010	1,583	2,551	1,915	258	60	6,367
September 2010	1,890	4,413	6,013	3,079	1,000	16,395
October 2010	1,964	6,330	9,914	5,994	780	24,982
November 2010	1,878	4,031	6,355	4,189	576	17,028
December 2010	1,785	2,945	11,227	10,125	682	26,765
January 2011	88	1,096	4,970	4,371	60	10,584
February 2011	111	933	4,047	2,821	70	7,983
March 2011	275	1,198	5,701	3,298	45	10,517
April 2011	1,783	4,342	8,179	1,481	161	15,946
TOTAL	14,908	37,038	68,549	38,229	4,800	163,524

Table II. Landed weight in kilogram by month and size grade for cod landed by all gillnet vessels (except the trial vessels) from the North Sea and Skagerrak, May 2010 – April 2011.

<i>All vessels</i> NS/SK	Landed weight per size grade					Total
	1	2	3	4	5	
May 2010	11,574	27,438	28,809	10,557	3,896	82,274
June 2010	33,052	75,404	73,070	28,813	4,443	214,782
July 2010	20,547	42,701	38,904	16,485	2,318	120,955
August 2010	31,973	62,975	37,827	16,420	2,403	151,599
September 2010	23,731	40,415	36,867	20,933	3,906	125,851
October 2010	45,843	95,343	79,280	37,220	4,558	262,244
November 2010	64,186	137,451	134,008	40,770	3,048	379,463
December 2010	51,101	130,939	211,371	90,426	9,315	493,152
January 2011	68,399	110,732	109,331	47,518	5,954	341,934
February 2011	26,684	65,539	57,107	30,481	1,566	181,377
March 2011	23,616	59,396	55,950	37,641	2,797	179,399
April 2011	26,695	29,255	21,633	13,510	1,842	92,936
TOTAL	427,400	877,589	884,158	390,773	46,045	2,625,966

Table III. Landed weight in kilogram by month and size grade for cod landed by the trial vessels from Øresund, May 2010 – April 2011.

<i>Trial vessels</i> <i>Øresund</i>	Landed weight per size grade					Total
	1	2	3	4	5	
May 2010		40	848	394	108	1,390
June 2010		39	696	8,202	3,561	12,497
July 2010			198	1,555	730	2,483
August 2010		11	289	1,170	801	2,271
September 2010			35	7,158	4,055	11,248
October 2010			45	4,283	1,335	5,663
November 2010			649	5,910	1,564	8,123
December 2010		12	817	2,864	539	4,231
January 2011		294	7,118	10,260	821	18,494
February 2011	25	112	911	2,354	152	3,554
March 2011	208	259	166	422	106	1,162
April 2011		8	164	117	26	315
TOTAL	233	773	11,936	44,689	13,800	71,431

Table IV. Landed weight in kilogram by month and size grade for cod landed by all gillnet vessels (except the trial vessels) from Øresund, May 2010 – April 2011.

<i>All vessels</i> <i>Øresund</i>	Landed weight per size grade					Total
	1	2	3	4	5	
May 2010	0	7	665	1,036	986	2,694
June 2010			629	12,201	16,886	29,716
July 2010		50	2,053	18,099	8,166	28,368
August 2010			1,323	12,495	7,678	21,496
September 2010		56	327	39,889	28,723	68,995
October 2010	29	109	386	56,395	30,706	87,625
November 2010	15	89	1,204	52,641	22,219	76,169
December 2010	59	393	1,850	16,644	4,447	23,392
January 2011	32	1,008	20,510	28,177	6,075	55,801
February 2011	35	192	3,347	11,429	9,327	24,329
March 2011	140	637	6,972	25,473	28,249	61,472
April 2011	0	32	741	3,873	3,407	8,052
TOTAL	310	2,572	40,005	278,353	166,869	488,109