



Measurements of Environmental Gamma-Ray Spectra using a Multi-Element TL Dosemeter

Furuta, S.; Bøtter-Jensen, L.; Nielsen, Sven Poul

Publication date:
1987

Document Version
Publisher's PDF, also known as Version of record

[Link back to DTU Orbit](#)

Citation (APA):

Furuta, S., Bøtter-Jensen, L., & Nielsen, S. P. (1987). *Measurements of Environmental Gamma-Ray Spectra using a Multi-Element TL Dosemeter*. Risø National Laboratory. Risø-M No. 2637

General rights

Copyright and moral rights for the publications made accessible in the public portal are retained by the authors and/or other copyright owners and it is a condition of accessing publications that users recognise and abide by the legal requirements associated with these rights.

- Users may download and print one copy of any publication from the public portal for the purpose of private study or research.
- You may not further distribute the material or use it for any profit-making activity or commercial gain
- You may freely distribute the URL identifying the publication in the public portal

If you believe that this document breaches copyright please contact us providing details, and we will remove access to the work immediately and investigate your claim.

Measurements of Environmental Gamma-Ray Spectra Using A Multi-Element TL Dosemeter

Sadaaki Furuta, Lars Bøtter-Jensen and Sven P. Nielsen

Risø-M- 2637

MEASUREMENTS OF ENVIRONMENTAL GAMMA-RAY SPECTRA
USING A MULTI-ELEMENT TL DOSEMETER

Sadaaki Furuta*, Lars Bøtter-Jensen and
Sven P. Nielsen

* Health and Safety Division, Oarai Engineering Center,
Power Reactor and Nuclear Fuel Development Corporation;
Oarai-machi, Higashi-Ibaraki-gun, Ibaraki-ken, Japan.

Abstract. A method to estimate the energy distribution and dose of environmental gamma radiation was developed using a multi-element TL dosimeter. Experimentally obtained energy responses from a multi-element TL dosimeter with different kinds of filters were used to calculate the energy distribution and related dose by the SAND-II computer code. The code was originally developed to estimate the neutron flux using a multiple foil activation method. Measurements were made at several locations with the multi-element TL dosimeter and comparisons were made with results from a NaI(Tl) scintillation detector and a high-pressure ionization chamber.

December 1986

Risø National Laboratory, DK-4000 Roskilde, Denmark

ISBN 87-550-1313-9

ISSN 0418-6435

Grafisk Service Risø 1986

CONTENTS

	Page
1. INTRODUCTION	5
2. MATERIALS AND METHODS	6
2.1. Multi-element TLD	6
2.1.1. Theory	6
2.1.2. Multi-element TLD-system	10
2.1.3. Energy responses	12
2.1.4. Test analysis	16
2.2. Reference TLD	29
2.3. NaI(Tl) spectrometry	29
2.3.1. NaI(Tl) spectrometry system	29
2.3.2. Response matrix method	33
2.3.3. G-function method	37
2.4. High-pressure ionization chamber	39
2.5. Plastic scintillation dosimeter	39
3. MEASUREMENTS	40
3.1. Measurement of the cosmic-ray component	40
3.2. Source irradiation	40
3.3. Natural field measurement	41
4. RESULTS AND DISCUSSION	41
5. CONCLUSION	55
ACKNOWLEDGEMENTS	55
REFERENCES	56

1. INTRODUCTION

The increased number of nuclear power plants and the possibility of their being involved in accidents have shown the necessity for environmental gamma radiation measurements. This need was emphasized especially after the accidents at Three Mile Island and Chernobyl. Although a continuous radiation monitoring system is very costly, it still may be necessary for detecting radioactive leakages from a facility. In addition a monitoring system using passive dosimeters, as the TL dosimeter, is widely accepted because of the easy handling and the low cost, despite the disadvantage of obtaining only an accumulated dose.

In order to detect the radiation from facilities, there appears to be two kinds of methods. One is to detect the variation from the normal level of the total gamma radiation, the other to detect the specific gamma radiation. The former may be available for continuous measurements and the latter for spectroscopy measurements. For TLD measurements a spectroscopy method might be preferable owing to its long measuring period in the environment. Several attempts to assess the effective energy of photons have been made using a multiple TL dosimeter with different filters^{1,2,3,4}). One of them was done for the purpose of measuring the Xe-133 released from a nuclear power plant accident⁴). But the information obtained by these methods was only the effective energy in addition to the exposure.

This report describes a new technique to obtain not only the effective gamma-ray energy but also the energy distribution of environmental gamma-rays by using a TL dosimeter in combination with different filters. The dosimeter is named a multi-element TL dosimeter.

2. MATERIALS AND METHODS

2.1. Multi-element TLD

2.1.1. Theory

The evaluation of the dose and gamma-ray dose-weighted energy spectrum was accomplished on the basis of the technique used in the SAND-II computer code^{5,6}). This code was originally made to determine the neutron flux energy spectra using a multiple foil activation technique and iterative calculation.

The simplest foil activation equation might be written:

$$M = \int_0^{\infty} \sigma(E) * \phi(E) dE \quad (1)$$

where

M: produced number of atoms of a foil (n)

σ : cross section of a foil (cm²)

ϕ : neutron fluence (n/cm²)

The integral equation with multiple foil detectors is re-written as follows from E.(1)

$$M_i = \int_0^{\infty} \sigma_i(E) * \phi(E) dE \quad (2)$$

The index *i* refers to the *i*th foil detector. Usually more than 10 different foil detectors are used in order to cover a wide range of neutron energies. The SAND-II code has been developed to obtain $\phi(E)$ from the measured activities M_i using the cross section data $\sigma_i(E)$.

The iterative algorithm used in the SAND-II code may be written as follows:

$$\phi_j[k+1] = \phi_j[k] * \exp\{C_j[k]\}, \quad j=1,2,\dots,m \quad (3)$$

where

$$C_j[k] = \frac{\sum_i^n W_{i,j}[k] * \ln(A_i/A_i[k])}{\sum_i^n W_{i,j}[k]}, \quad j=1,2,\dots,m \quad (4)$$

$$W_{i,j}[k] = A_{i,j}[k]/A_i[k], \quad j=1,2,\dots,m; \quad i=1,2,\dots,n \quad (5)$$

$$A_{i,j}[k] = \phi_j[k] * \sigma_{i,j}, \quad j=1,2,\dots,m; \quad i=1,2,\dots,n \quad (6)$$

$$A_i[k] = \sum_j^{m'} A_{i,j}[k], \quad i=1,2,\dots,n \quad (7)$$

$\phi_j[k]$: kth iterative flux over the jth energy interval

$C_j[k]$: kth iterative flux correction term for the jth energy interval

A_i : measured activity for the ith foil detector reaction

$A_i[k]$: calculated activity for the ith foil detector reaction based on the kth iterative flux spectrum

$A_{i,j}[k]$: the portion of $A_i[k]$ contributed by neutrons in the jth energy interval

$\sigma_{i,j}$: ith foil detector cross section (constant) over the jth energy interval

E_j : lower energy bound of the jth energy interval

k : iteration number

m : total number of energy intervals

n : number of detectors used

From the weighting function (Eq.(5)), the calculated neutron flux will give the best agreement between the measurements and calculations of each foil-detector's activity.

This method is widely used for measuring the neutron flux in a nuclear reactor. For health physics research, other detectors have been used to analyze neutron spectra, i.e. a neutron counter with several moderators like the Bonner-ball counter and the SAND-II code is often used for the unfolding method⁷⁾. Recently the neutron dose of the atomic bomb in Nagasaki was re-calculated using produced isotopes in sliced andesite (rock) and the SAND-II code⁸⁾.

Previously no work on gamma-ray spectrum analysis by this kind of unfolding method has been reported probably because many other methods are available (NaI(Tl) or Ge spectrometry). But it might be interesting to use the SAND-II code for gamma-ray spectrum analysis with economical and passive TL dosimeters.

For the multi-element TLD an equation similar to Eq.(1) can be written:

$$T = \int_0^{\infty} R(E)D(E)dE \quad (7)$$

where

- T : observed TLD signal
- R(E) : TLD energy response relative to Co-60 irradiation
- D(E) : gamma-ray dose spectrum

It is possible to use the SAND-II code for analysis of the results from the multi-element TLD just by replacing M, $\sigma(E)$ and $\phi(E)$ in Eq(1) with T, R(E) and D(E), respectively.

The theory of SAND-II code is simple, but the code is rather comprehensive because of several options for the evaluation of neutron flux. Some of these options are inconvenient for gamma-ray analysis by TLD, however. In addition, it is necessary to make several corrections (e.g., change the fixed energy intervals).

For this reason we decided to make another code using the SAND-II algorithm for calculating the multi-element TLD data.

We used a five-element TL dosimeter where the filters had quite different energy dependencies. An energy range of 10 keV to approximately 3 MeV was considered for measuring the environmental gamma-rays.

Each decade of the energy range was divided into 10 intervals, equidistant on the log-scale, resulting in 25 intervals for the actual energy range of 10 keV to 3.16 MeV. All spectra on the log-scale are described as histograms of total dose in each energy interval without weighting energy widths. Because it might be more convenient seeing both continuous and peak spectra relating the dose.

An initial spectrum is necessary for the iterative calculation. A constant was used in the log-scale energy representation described above (i.e. a decreasing function according to a linear-scale energy representation) for the present study because this has been shown to be a good initial spectrum to use for all the gamma-ray energy distributions studied. As the calculated spectrum has a tendency to depend on the initial spectrum especially in the less sensitive part of energy interval, the suggested initial spectrum is useful in finding significant trends of the gamma-ray energy distribution.

For the iterative calculations, the general rule applies that the higher the number of calculations, the higher the precision of the calculated results. But due to the errors in measurement, there is no additional advantage gained in increasing the number of iterations above a certain limit (see 2.1.4.). We found that the combination of the above-mentioned initial spectrum and a maximum of 30 iterations is sufficient for both continuous and monoenergetic spectra.

2.1.2. Multi-element TLD system

CaSO₄:Dy TL material was chosen because of its high sensitivity, low fading, and distinct profile of strong energy dependence. Sintered CaSO₄:Dy pellets of 35 mg weight with diameter of 4.5 mm and thickness 0.8 mm became available from the Boris Kidric Institute, Yugoslavia⁹).

The CaSO₄:Dy pellets were pre-irradiation annealed at 300°C for 30 minutes and post-irradiation annealed at 100°C for 20 minutes. The latter annealing was made in order to remove the low-temperature peaks of the glow curve. The TLD pellets were measured in an automated TLD reader that uses hot N₂-gas as the heating medium¹⁰).

Filter materials and thicknesses were chosen on the basis of gamma-ray absorption calculations. This resulted in the design of a five-element dosimeter equipped with filters of 1 mm Al (#1), 1 mm Cu (#2), 6 mm Cu (#3), 2 mm Pb (#4), and 10 mm Pb (#5). The standard Risø TLD holder for routine monitoring was provided with 1 mm Al and 1 mm Cu cover plates for elements #1 and #2, respectively, and special cylindrical containers made of Cu and Pb were designed for elements #3, #4, and #5.

Six CaSO₄:Dy pellets were contained in each element to improve the measurement precision. Thus two holders for each element of #1 and #2, and one container for #3, #4, and #5. All CaSO₄:Dy pellets were calibrated individually against Co-60 radiation, and outlier TL signals were eliminated on the basis of a statistics method to increase the precision¹¹). Six pellets contained in a thin plastic tube were put into each container.

For field measurements the multi-element TL dosimeters were placed in sealed plastic bags to shield them from humidity. An exploded view of the five-element TL dosimeter is shown in Fig.1.

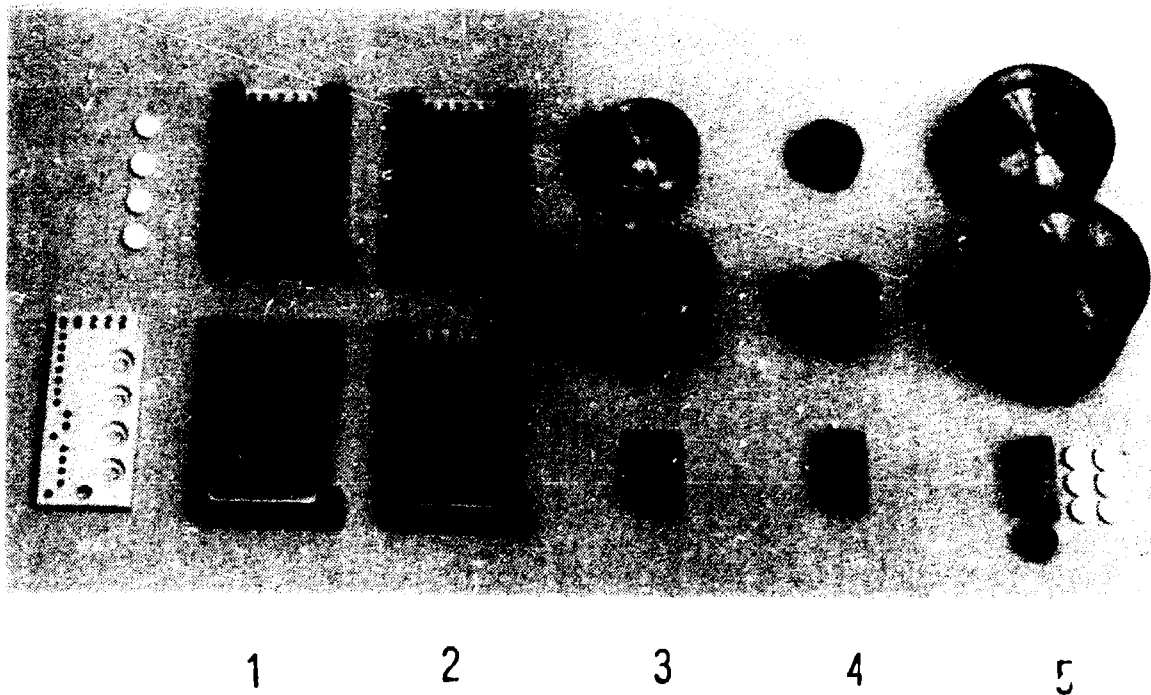

Fig. 1. Exploded view of the five-element environmental CaSO₄:Dy TL dosimeter. Filters are: #1 1 mm Al, #2 1 mm Cu, #3 6 mm Cu, #4 2 mm Pb, #5 10 mm Pb.

To the left: Risø TLD holders with Al and Cu plates. A holder-slide with ID coding together with sintered CaSO₄:Dy TLD pellets are shown as well.

To the right: Cylindrical shields with open lids made of Cu and Pb. Plastic tubes each containing six CaSO₄:Dy TLD pellets for insertion into the cylindrical shields are shown beneath.

2.1.3. Energy responses

Gamma-ray energy response curves used as input to the SAND-II computer code were obtained by exposing the dosimeters to mono-energetic X-rays and gamma-rays. Tables 1 and 2 show 12 ISO quality X-rays¹² and combination of filters, and 4 gamma-rays used in order to determine the energy responses. The X-ray machine used was from the Elema Shonander Corporation. The X-ray exposures were calibrated against Co-60 radiation by a secondary standard ionization chamber¹³). The gamma sources were calibrated against Co-60 radiation by LiF TLD 700 TL dosimeters, and for the purpose of making electron equilibrium, 1 and 5 mm plastic filters were used for Co-60 and Na-24 radiations, respectively.

Table 1. X-ray energy and irradiation conditions table for multi-element TLD energy response calibration.

Energy* (keV)	Voltage (kV)	Current (mA)	Added filter				Dose rate (mGy/min)	Irrad.time (min)	Total dose (mGy)
			Al	Cu	Sn	Pb			
9.8	12	15	0.3				2.12	3.0	6.35
16.2	20	15	1.5				0.992	3.0	2.98
22.9	30	15	3.6				1.48	2.0	2.96
31.7	40	20	4.0	0.21			1.15	2.0	2.30
46.2	60	20	4.0	0.6			1.32	2.0	2.64
64.4	80	20	4.0	2.0			0.774	3.0	2.32
83.2	100	20	4.0	5.0			0.397	5.0	1.99
101	120	20	4.0	5.0	1.0		0.485	5.0	2.29
120	150	20	4.0		2.5		3.32	1.0	3.32
166	200	15	4.0	2.0	3.0	1.0	0.966	3.0	2.90
210	250	15	4.0		2.0	3.0	0.957	3.0	2.87
251	300	10	4.0		3.0	5.0	0.631	4.0	2.52

* : Mean energy of exposure

** : irradiation distance 1 m

Table 2. Gamma-ray energy table used for the response calibration.

Energy (keV)	Yield (%)	Source	Half-Life	Decay type
320.1	100	Cr-51	27.7d	EC
661.6	85.1	Cs-137	30.3y	β^-
1252.8*	200	Co-60	5.26y	β^-
2754.0	99.9	Na-24	15.0h	β^-

*: Mean energy of 1173.2 keV and 1332.5 keV

Figure 2 shows the energy response curves relative to Co-60 radiation. In this figure the point at 2754 keV of the 1 mm Al filter is assumed to be 1. Because too high a response was observed due to the contribution of the high energy and strong intensity of beta-ray from Na-24.

Na-24 emits two gamma-rays, 1368.6 keV (100%) and 2754.0 keV (99.9%). The contribution of the first gamma-ray was then subtracted from the total response of Na-24 assuming that the response of 1253 keV (Co-60) was equal to that of 1368.6 keV Na-24.

These data were converted into SAND-II input data shown in Fig.3 using the CSTAPE code which is a sub-code of SAND-II and makes interpolated response data at each SAND-II energy interval.

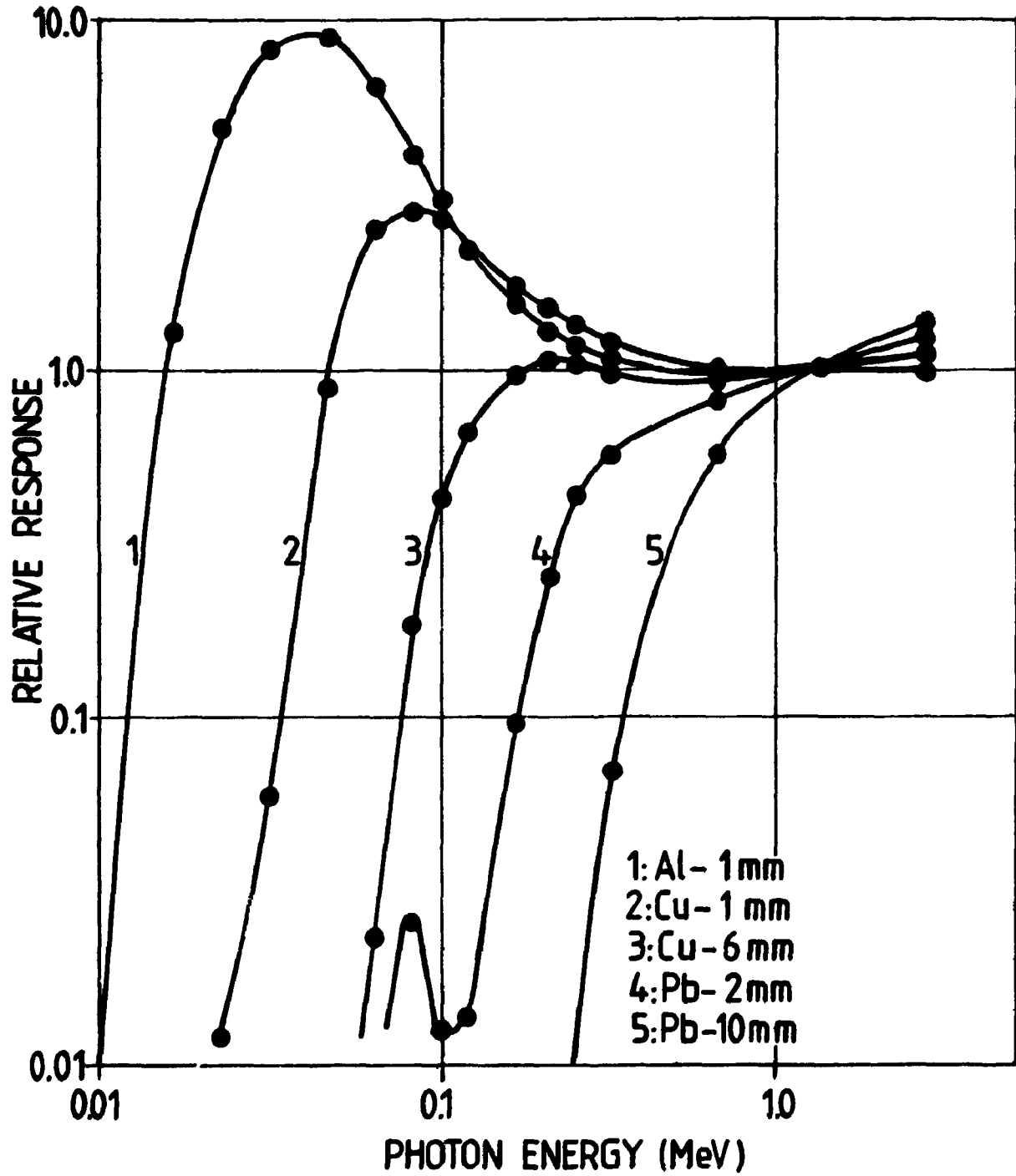

Fig. 2. Measured gamma-ray energy responses relative to that for Co-60 for the five-element $\text{CaSO}_4:\text{Dy}$ TL dosimeter.

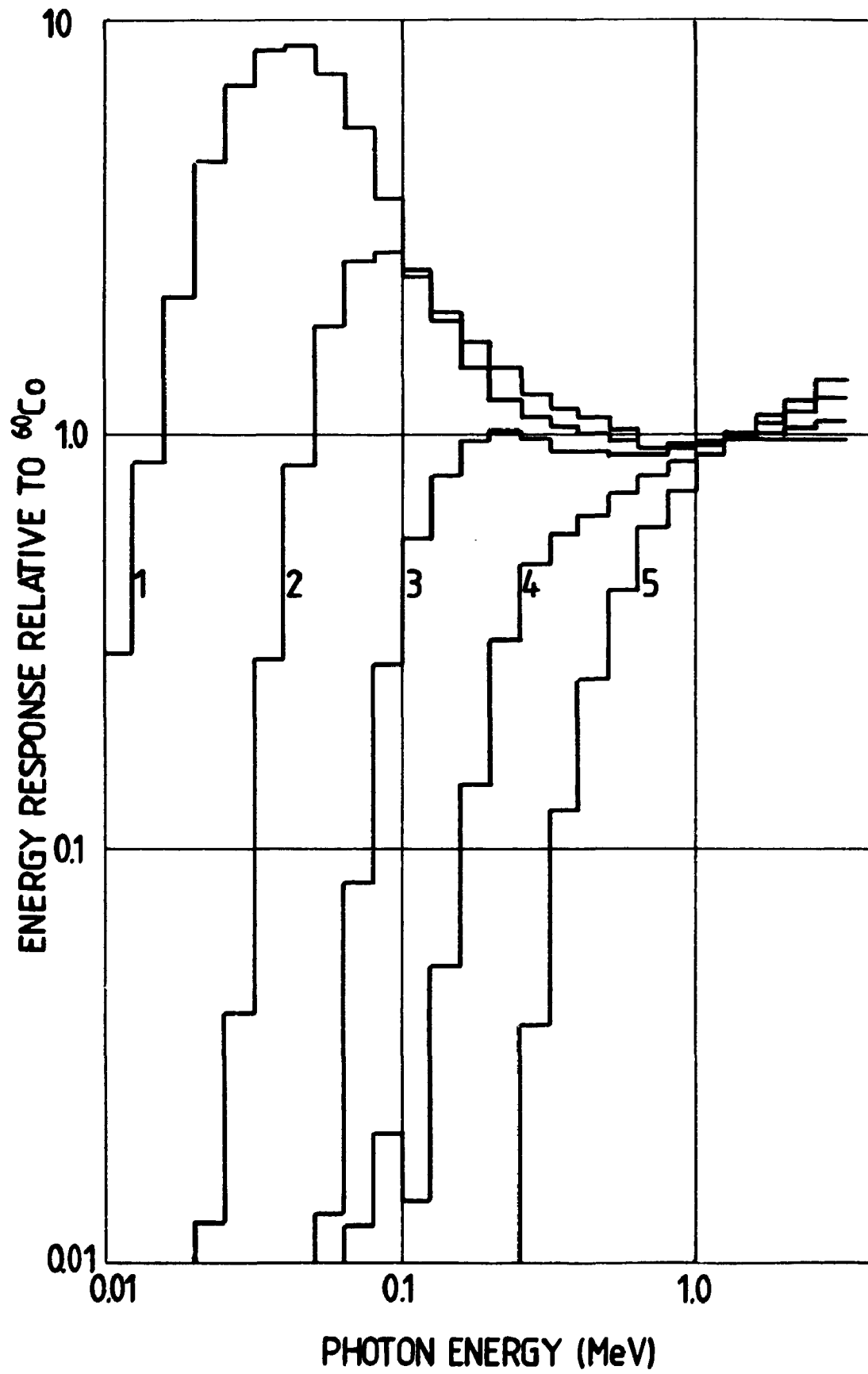

Fig. 3. Energy response curves serving as input to the SAND-II code.

2.1.4 Test analysis

In order to make sure of the method and gain information about the tendency of the energy resolution, some test analyses were made under several conditions. The TL signals relative to the Co-60 source obtained by the energy response calibration was used as SAND-II input TL signals and calculated with 10, 20, 30, 50, and 100 iterations. The output dose spectra are shown in Figures 4 to 11 at typical energy points 22.9 keV, 46.2 keV, 83.2 keV, 166 keV, 320.1 keV, 661.6 keV, 1252.8 keV, and 2754.0 keV.

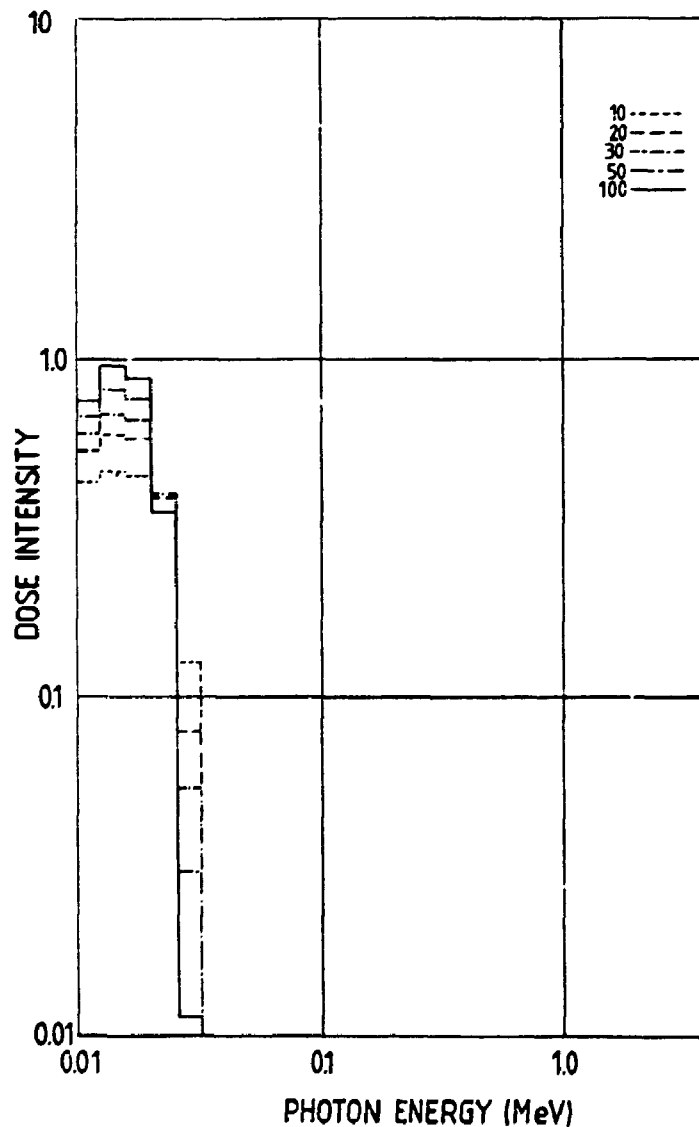

Fig. 4. Calculated dose spectrum at 22.9 keV with 10, 20, 30, 50, and 100 iterations.

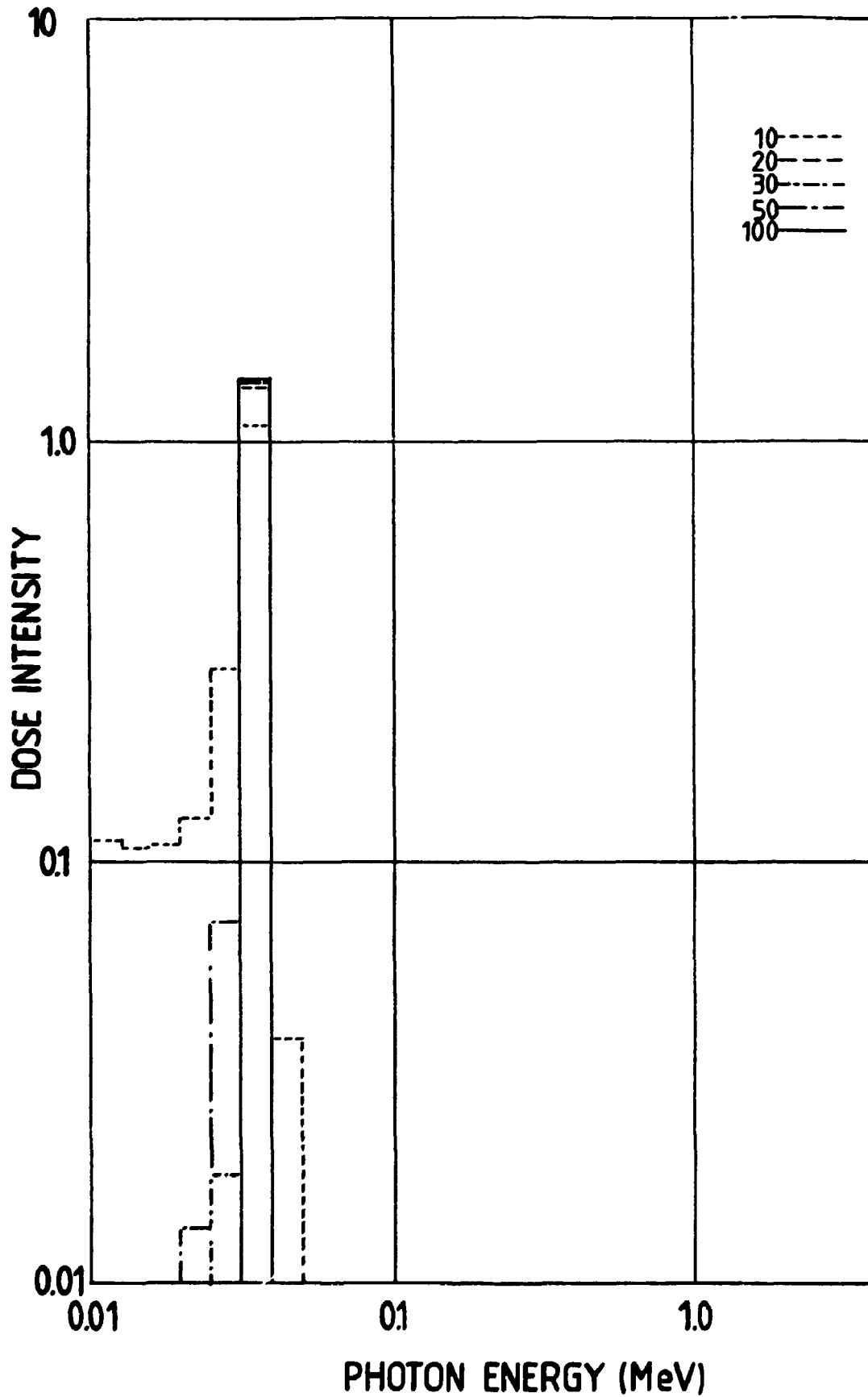

Fig. 5. Calculated dose spectrum at 46.2 keV with 10, 20, 30, 50, and 100 iterations.

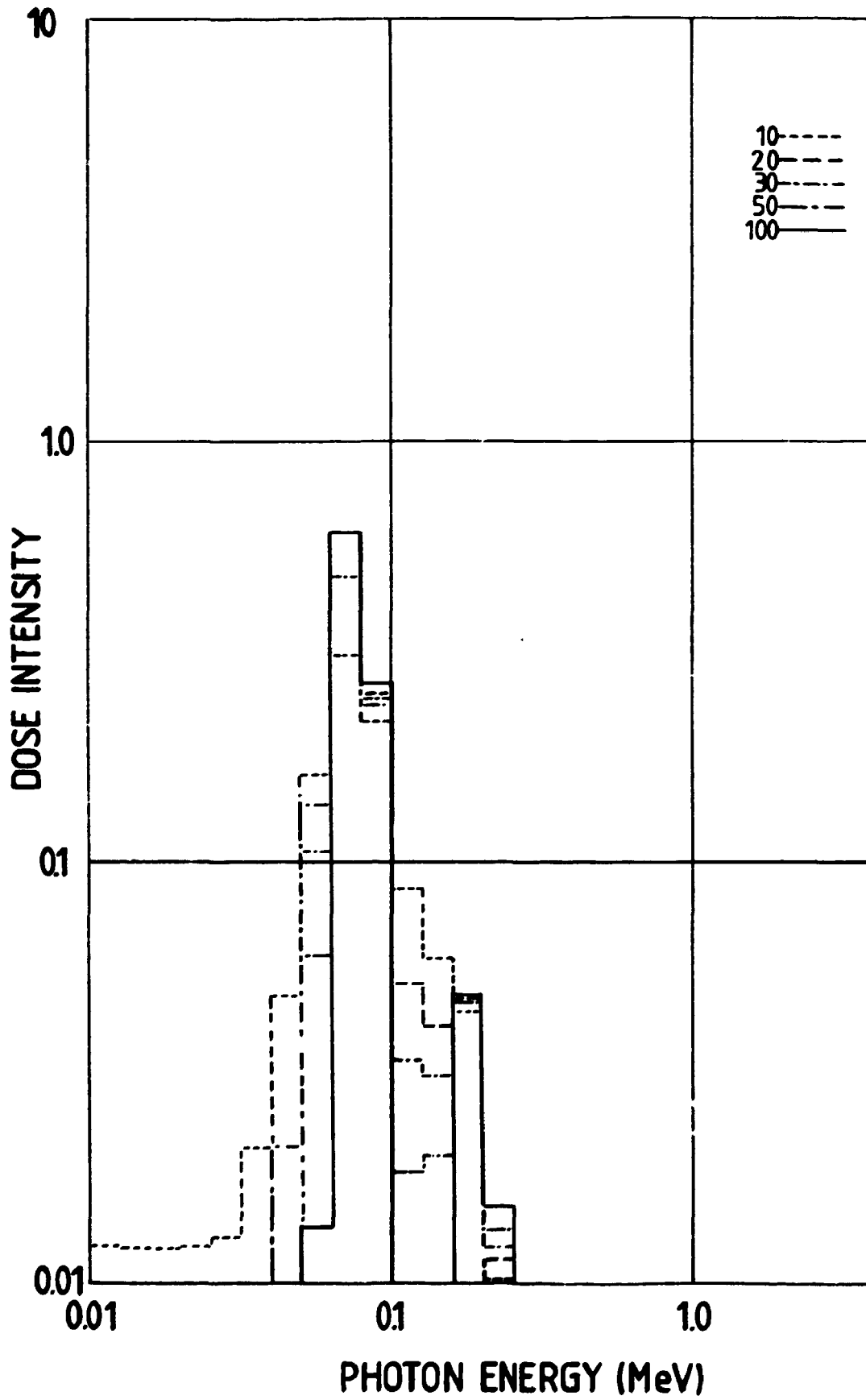

Fig. 6. Calculated dose spectrum at 83.2 keV with 10, 20, 30, 50, and 100 iterations.

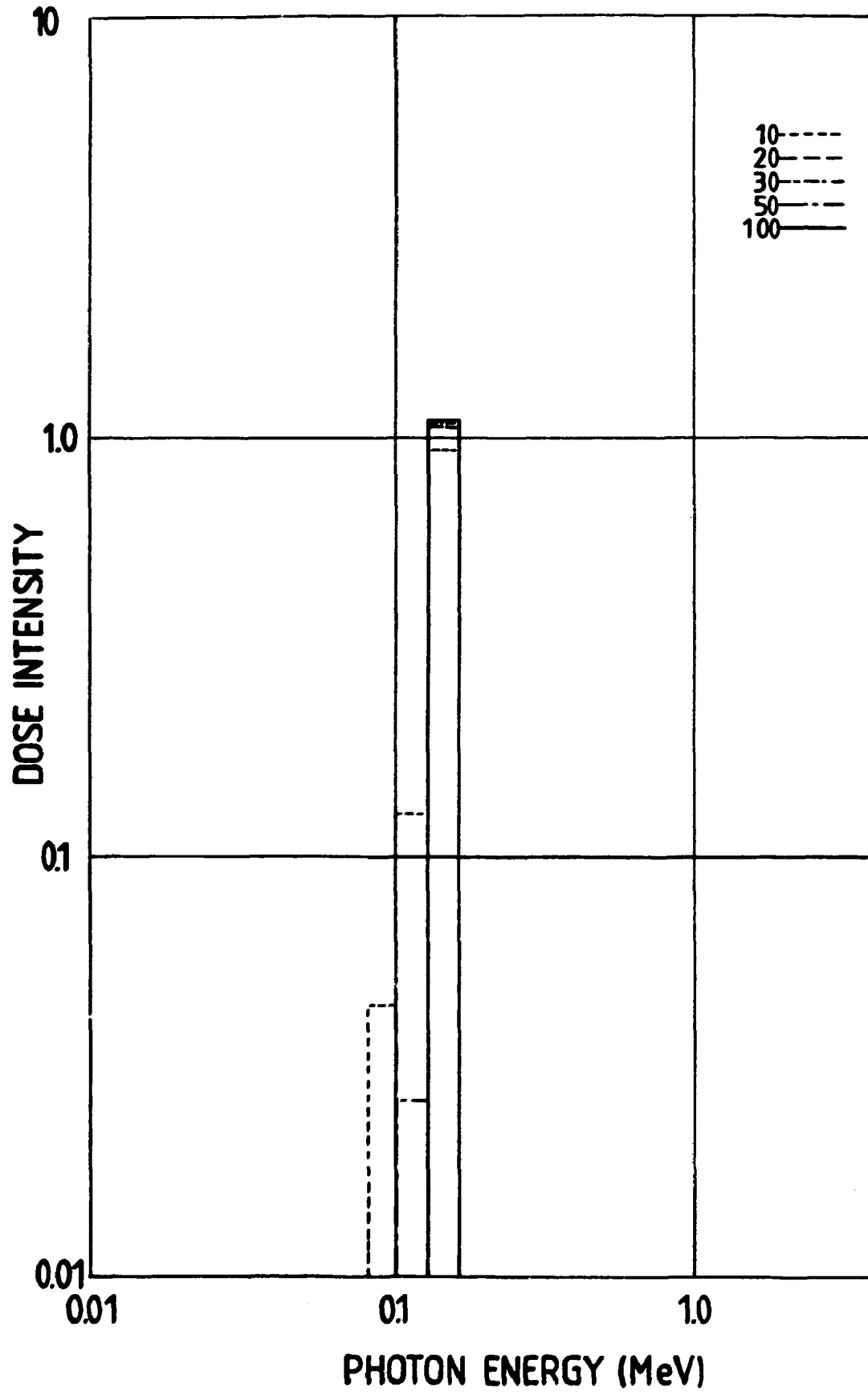

Fig. 7. Calculated dose spectrum at 166 keV with 10, 20, 30, 50, and 100 iterations.

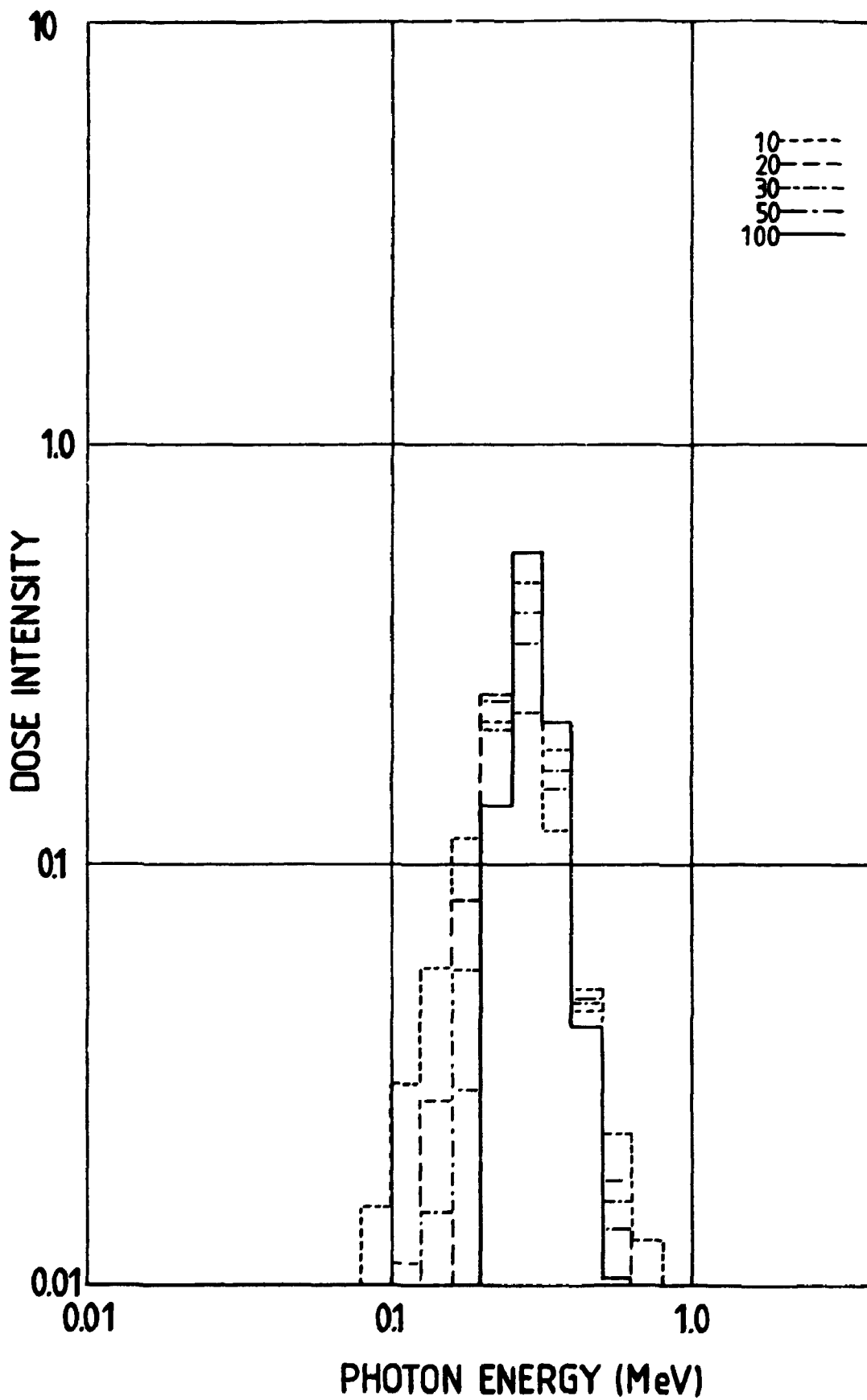

Fig. 8. Calculated dose spectrum at 320.1 keV with 10, 20, 30, 50, and 100 iterations.

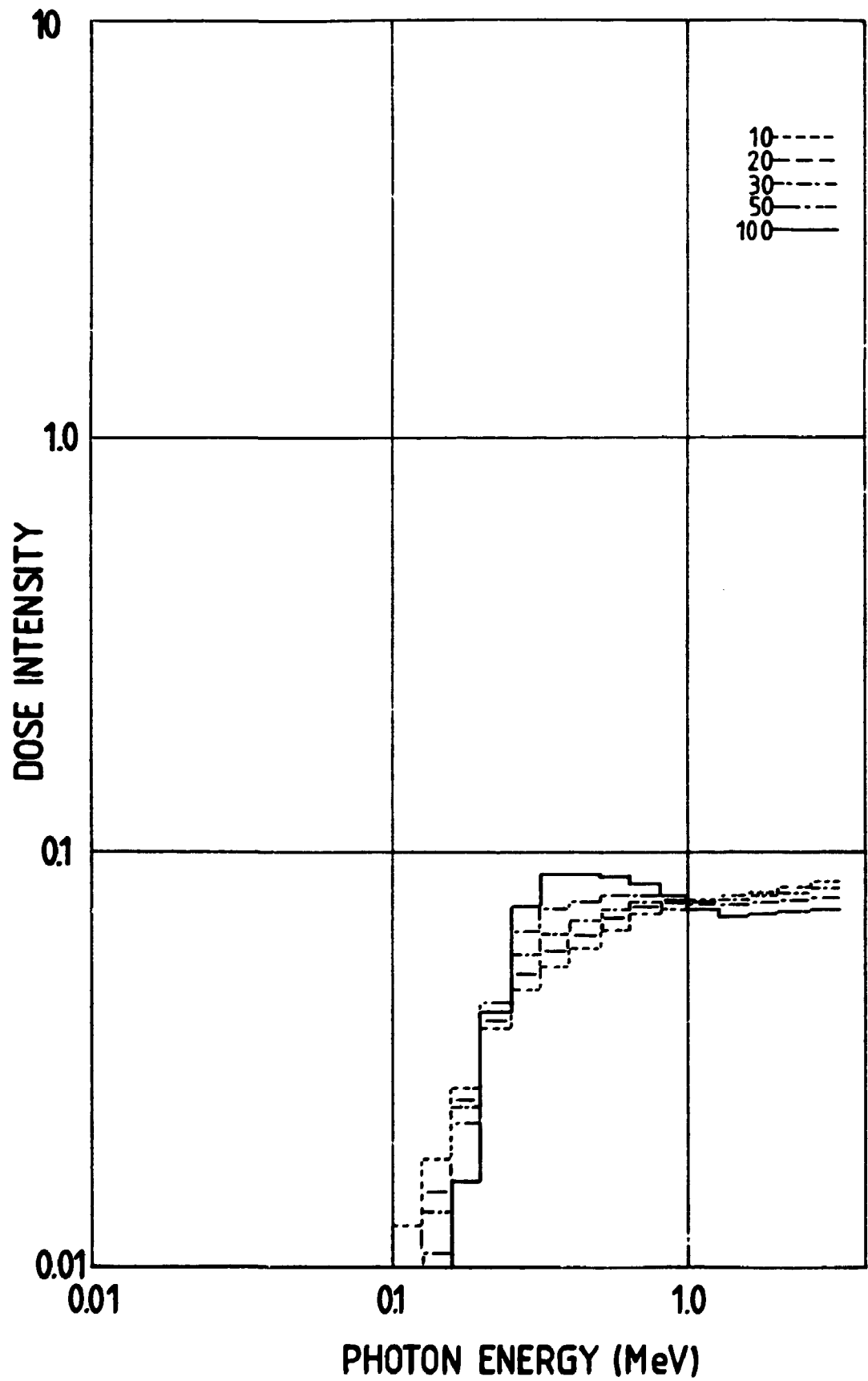

Fig. 9. Calculated dose spectrum at 661.6 keV with 10, 20, 30, 50, and 100 iterations.

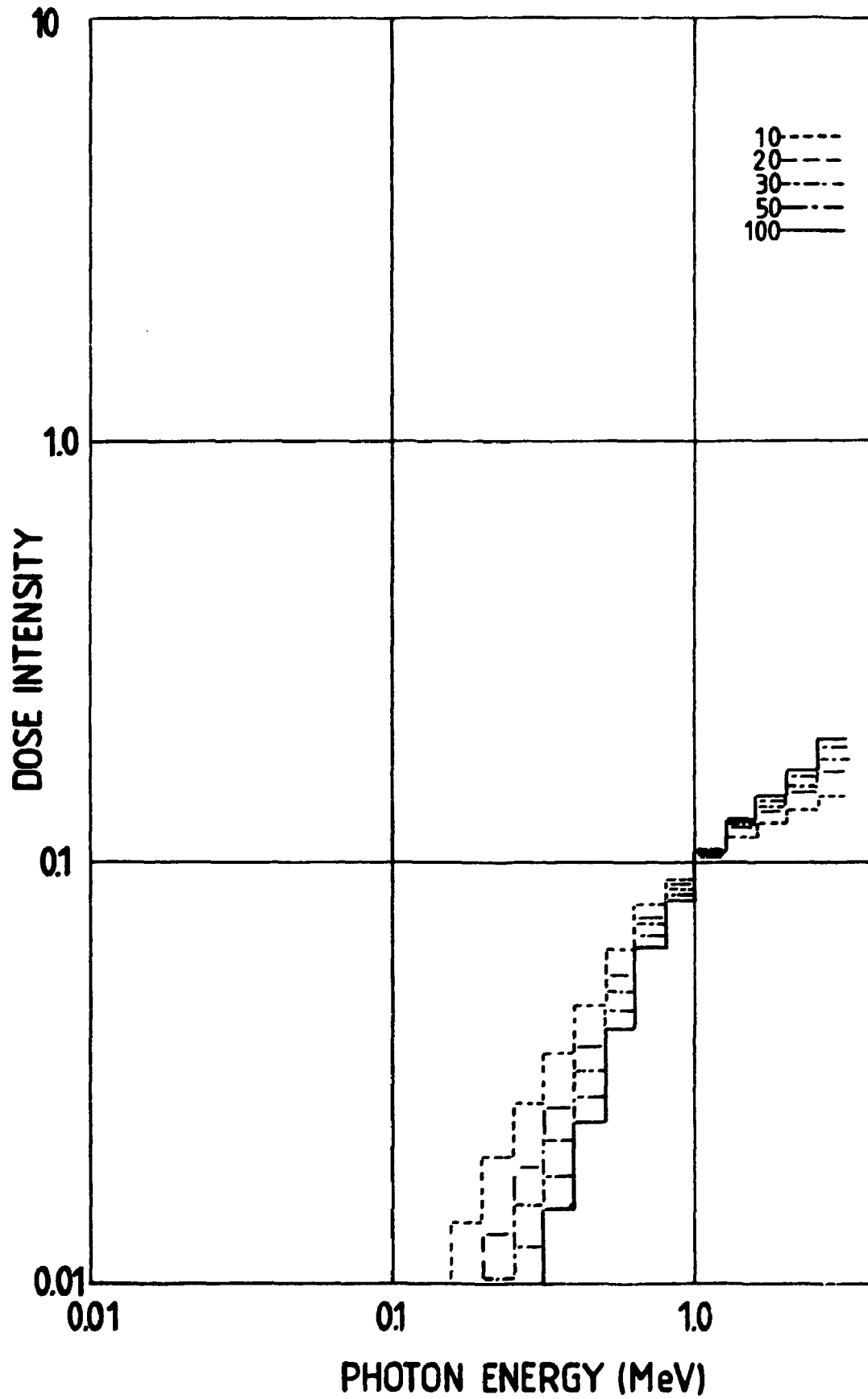

Fig. 10. Calculated dose spectrum at 1252.8 keV with 10, 20, 30, 50, and 100 iterations.

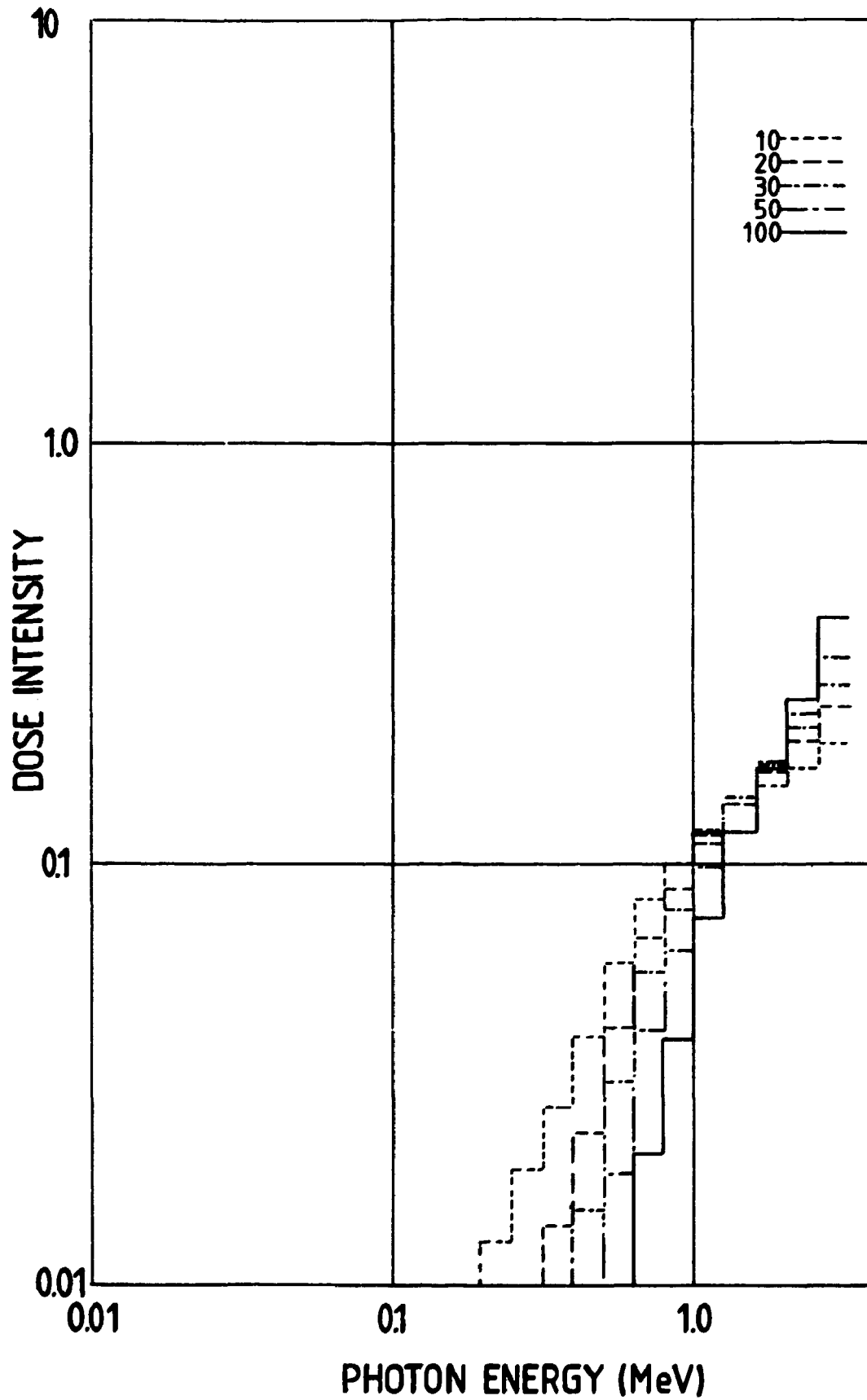

Fig. 11. Calculated dose spectrum at 2754.0 keV with 10, 20, 30, 50, and 100 iterations.

These data contain no error for the analyses except for error due to the interpolation of response curve and calculation by a computer. They might be a proper sample input data for obtaining the calculation.

In these figures it is obvious that the higher iterative number used, the higher will be the energy resolution. And at an extremely low-energy point at 22.9 keV, and in an energy range higher than 661.6 keV, the energy resolutions become rather poor because of lack of useful information from the energy response curves. In the low-energy range (< 0-40 keV) only few response curves are available, and in the high energy range (> 661.6 keV) the differences between the response curves become rather small in spite of the many curves. In the energy range from 46.2 keV to 320.1 keV, however, the energy resolution is quite satisfactory.

A small peak at 180 keV can be seen in Fig. 6 from the 83.2 keV X-ray irradiation. This peak may be due to an interpolation error because #4 TL element (Pb-2 mm filter) has a small peak at 83.2 keV in its energy response curve (Fig.2).

Table 3 shows the calculated output dose at typical energy points with a changing number of iterations. As the dose intensity used as an input of SAND-II is normalized into one unit here, it is expected that a single unit dose would be obtained as an output. There is some tendency to increase the doses in a low-energy range and an opposite tendency in a high-energy range with increasing iteration. This can be explained in that in low iterations the dose spectrum has a low-energy tail in the low-energy range and a high energy tail in the high-energy range. It is recognized that many iterations are not always useful, and about 30 may be sufficient.

Table 3. Calculated dose of unit irradiation using energy response calibration data.

Energy (keV)	Number of iterations				
	10	20	30	50	100
22.9	1.48	2.20	2.41	2.67	2.97
46.2	1.87	1.47	1.42	1.41	1.42
83.2	1.01	0.974	0.967	0.964	0.963
166.0	1.13	1.11	1.11	1.11	1.11
320.1	0.922	0.963	0.973	0.979	0.983
661.6	0.888	0.893	0.900	0.910	0.923
1252.8	1.02	1.0	0.996	0.989	0.983
2754.0	1.13	1.11	1.09	1.08	1.05

Next we assumed mixed fields with an energy combination, 83.2 and 320.1 keV, and combination 320.1 and 1252.8 keV using summation of the two TL signals from the energy response calibration. The calculated dose spectra are shown in Figures 12 and 13. It is quite easy to discriminate between the two energies in Fig.12 after only a few iterations, but it is quite difficult to recognize two peaks in Fig. 13 due to the poor resolution. Table 4 shows the calculated dose of each energy compared with the irradiated one, and good agreements were observed.

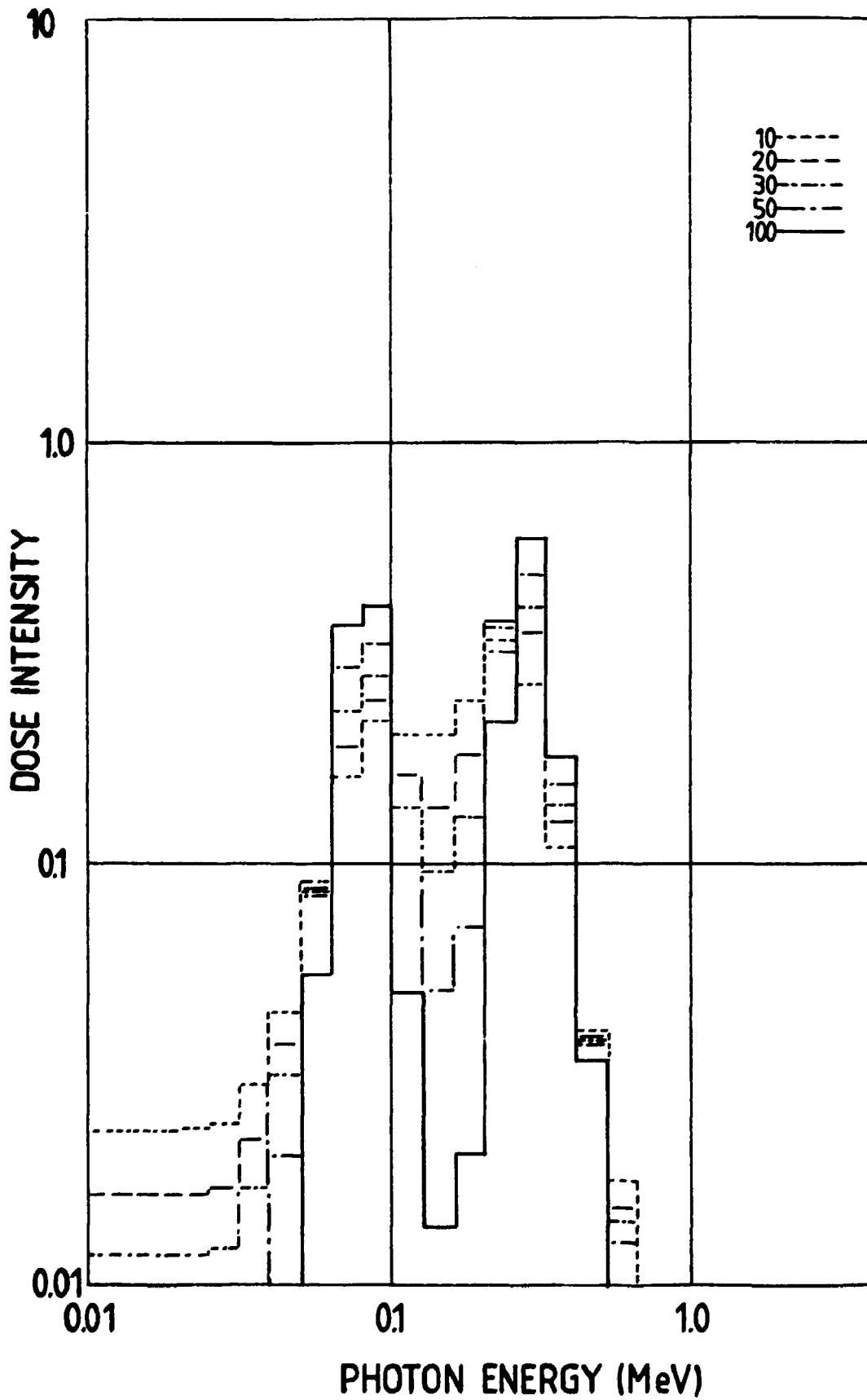

Fig. 12. Calculated dose spectrum for the combination of two energies 83.2 and 320.1 keV with 10, 20, 30, 50, and 100 iterations.

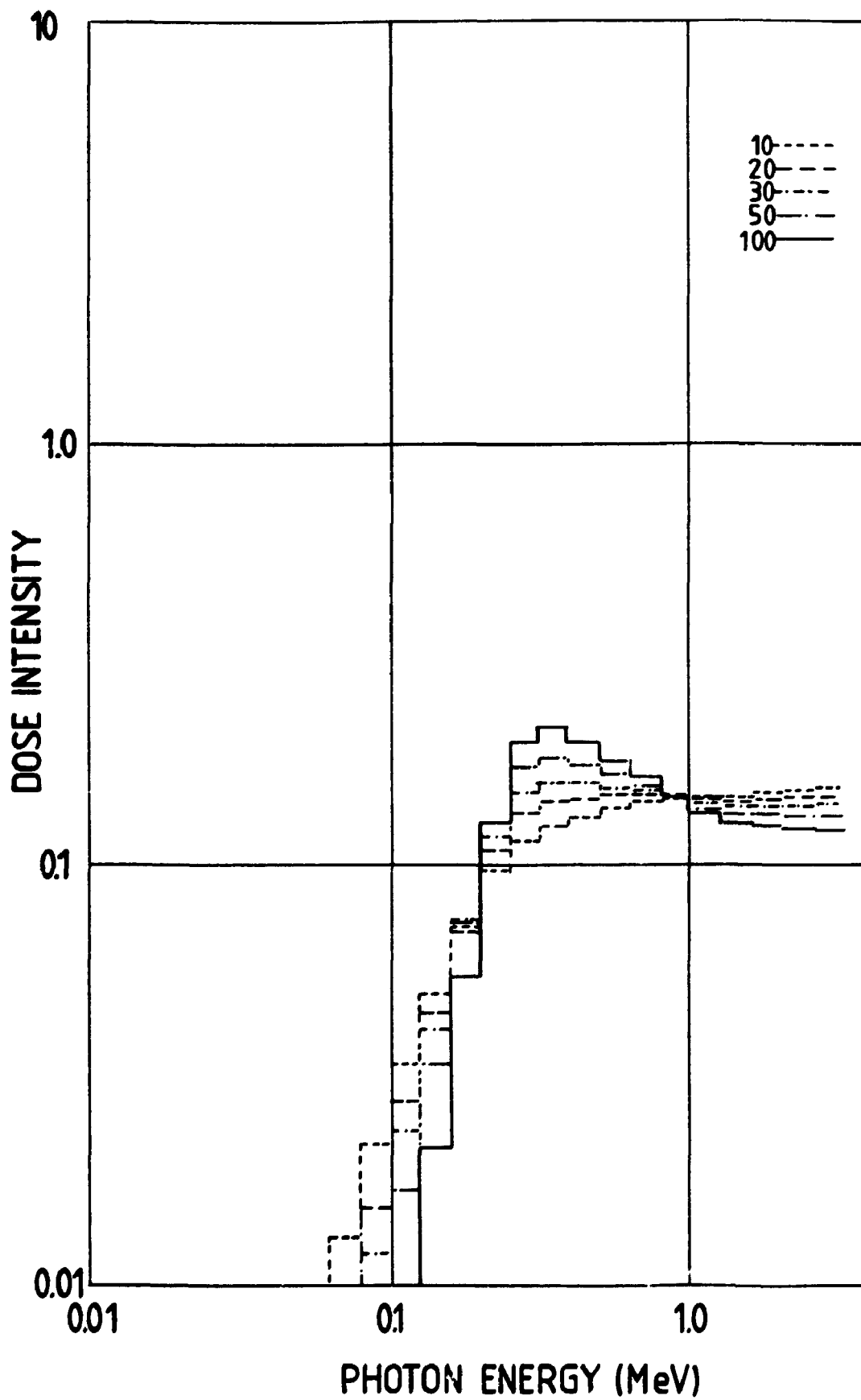

Fig. 13. Calculated dose spectrum for the combination of two energies 320.1 and 1252.8 keV with 10, 20, 30, 50, and 100 iterations.

Table 4. Calculated dose for the combination of two energies with unit dose, from the energy response calibration.

Energy (keV)	Ref. dose	Number of iterations				
		10	20	30	50	100
83.2	1.0	1.06	0.961	0.934	0.912	0.904
320.1	1.0	1.06	1.13	1.12	1.10	1.08
Total dose	2.0	2.12	2.09	2.05	2.01	1.98

Energy (keV)	Ref. dose	Number of iterations				
		10	20	30	50	100
320.1	1.0	-	-	-	-	-
1252.8	1.0	-	-	-	-	-
Total dose	2.0	1.86	1.89	1.91	1.93	1.96

- : Not possible to discriminate between the energies.

Using the natural field gamma-ray spectrum measured by the NaI(Tl) response matrix method (ref. 2.3.2) and multi-element TLD response curve, the expected TL signals were calculated and used as input data of SAND-II. The two spectra, measured by the NaI(Tl) response matrix method and calculated by SAND-II are shown in Fig.14. Although the resolution of multi-element TLD is poorer than that of the NaI(Tl) detector, the shape of both spectra are wholly consistent even after only a few iterations.

2.2 Reference TLD

The determinations of doses were based on energy-independent LiF TLD-700 dosimeters (Harshaw)¹⁰ that were irradiated by the different sources and were exposed in the environment simultaneously with the multi-element TL dosimeters. The LiF TL dosimeters were contained in Risø standard TLD holders equipped with individual build-up layers of lucite and were calibrated against Co-60 radiation. The LiF TLD's were pre-irradiation annealed at 400°C for one hour followed by two hours at 100°C and post-irradiation annealed at 100°C for 20 minutes.

2.3 NaI(Tl) spectrometry

2.3.1 NaI(Tl) spectrometry system

Figure 15 shows a schematic diagram of the NaI(Tl) spectrometry system. The spectra recorded with this system were analyzed with two methods: The Response Matrix Method and the G-function Method.

The detector dimensions were 3"x3" and the manufacturer was Geometrics/Exploranium Corp. The construction of the NaI(Tl) scintillation detector is shown in Fig.16. The amplifier gain was adjusted to cover the energy range up to 3 MeV. The output pulses

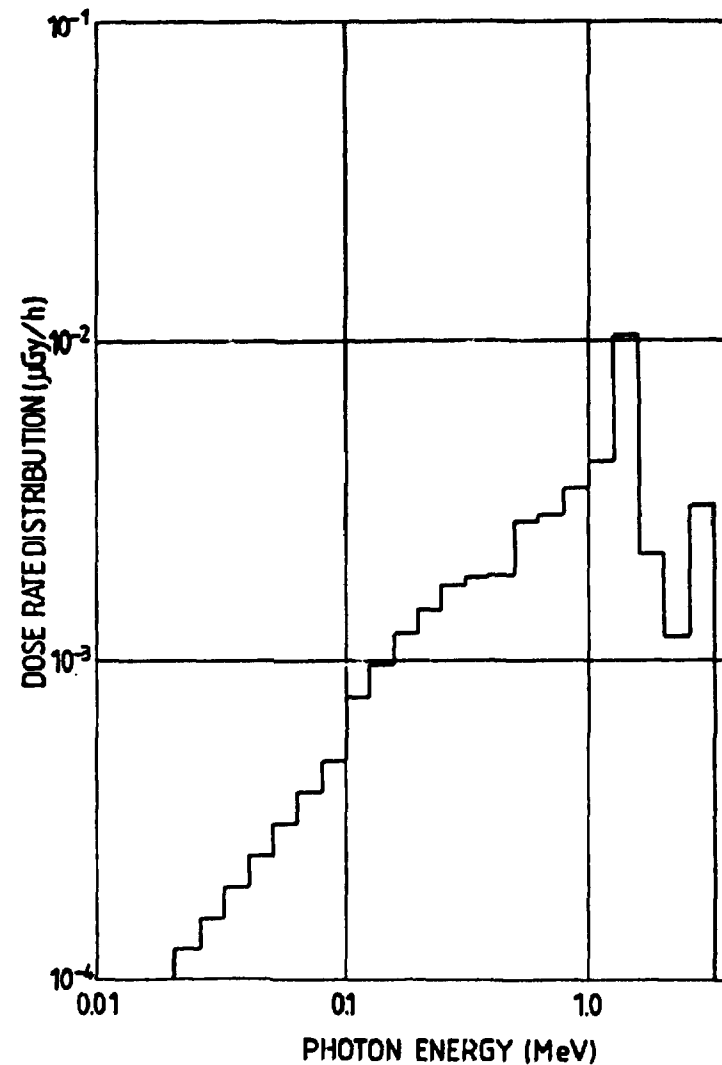
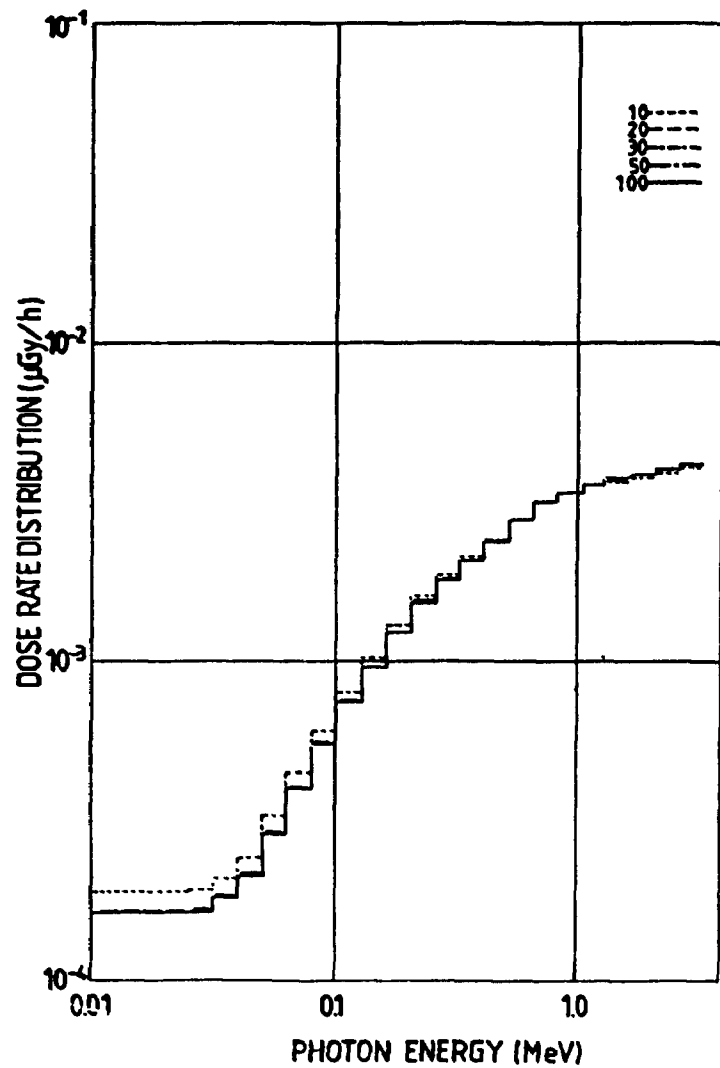

Fig. 14. Dose rate spectra calculated by the SAND-II code with the multi-element TL dosimeter (left), and calculated with the response matrix method from a NaI(Tl) spectrum (right) measured on a lawn field.

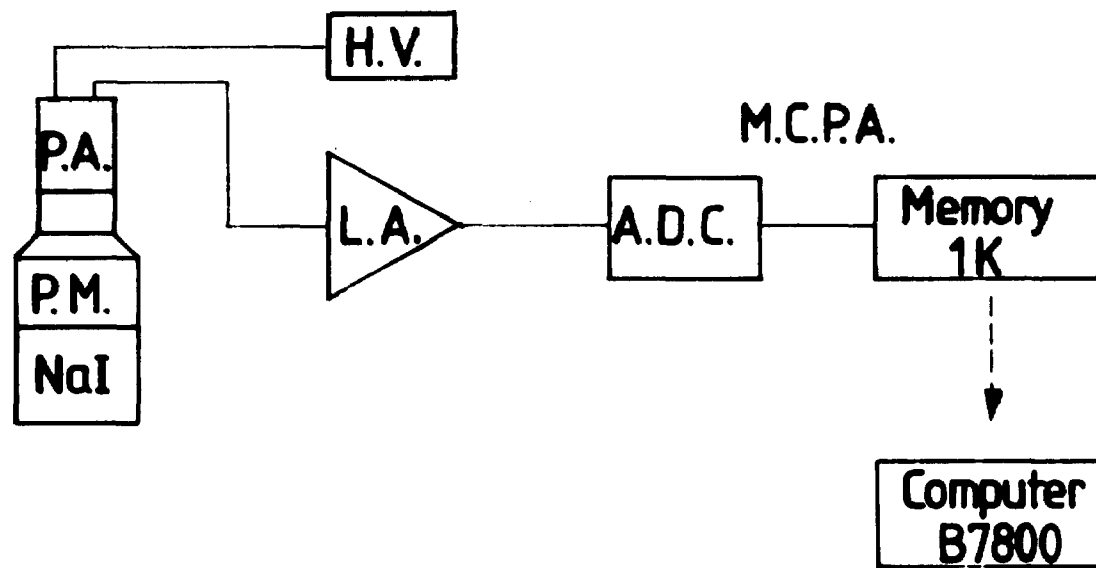

Fig. 15. Schematic diagram of the NaI(Tl) spectrometry system.

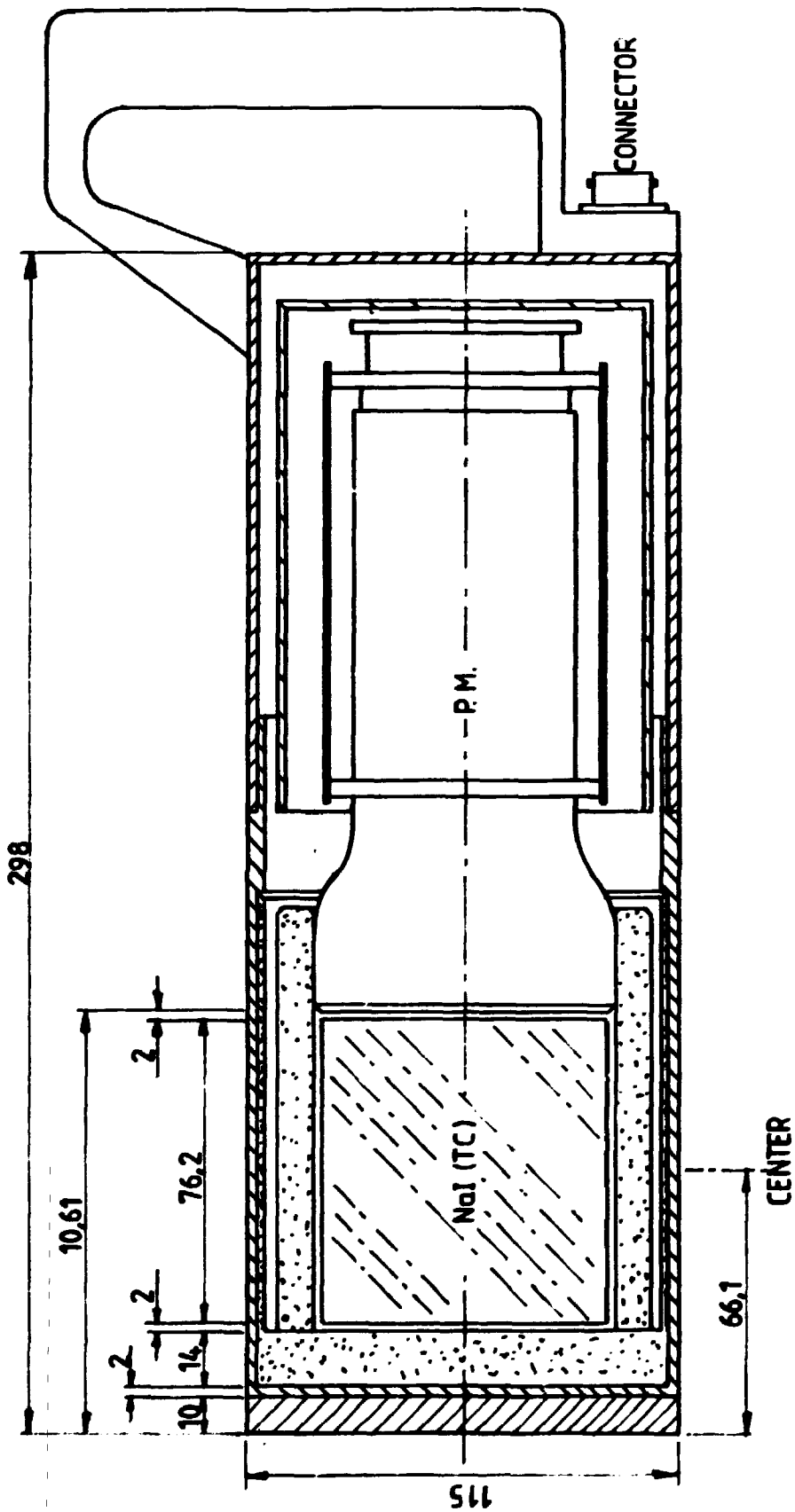

Fig. 16. Construction of the NaI(Tl) detector.

from the main amplifier were analyzed and stored in the 1024-channel memory of a multichannel analyzer, and after measurements the data were transferred and processed on the central computer at the laboratory.

It is easy to discriminate against the counts in the spectra from the cosmic-ray component with energies above 3 MeV. But it is known that the cosmic-ray components is still present at energies lower than 3 MeV (Fig.17). The data in Fig.17 was reported by other authors using a simultaneous counting technique¹⁴). It is rather difficult to discriminate below the 3 MeV energy range without a special technique. In this study we have assumed that the cosmic-ray distribution is constant up to 3 MeV. This constant was estimated from the number of counts between 2.80 MeV and 3 MeV and subtracted from the spectrum in order to obtain the gamma-ray component only. The error of the dose calculation introduced from this assumption is small, because the difference between the constant and the cosmic-ray pulse height distribution is small and appears only in the low-energy range.

2.3.2 Response matrix method

The pulse height spectrum obtained from the multi-channel analyzer is not the true gamma-ray energy spectrum in the field, but the result of interactions between gamma-rays and the NaI(Tl) scintillator. To obtain the true gamma-ray energy spectrum it is necessary to unfold the measured pulse-height spectrum using the response matrix method.

The pulse-height spectrum might be written as follows:

$$C(E) = \int_0^{\infty} R(E',E) * N(E) dE' \quad (1)$$

where

- C(E) : measured pulse-height spectrum
- R(E',E): response function of the NaI(Tl) scintillator (the probability of producing a pulse with energy E' from an incident gamma-ray with energy E)
- N(E) : incident true gamma-ray energy spectrum

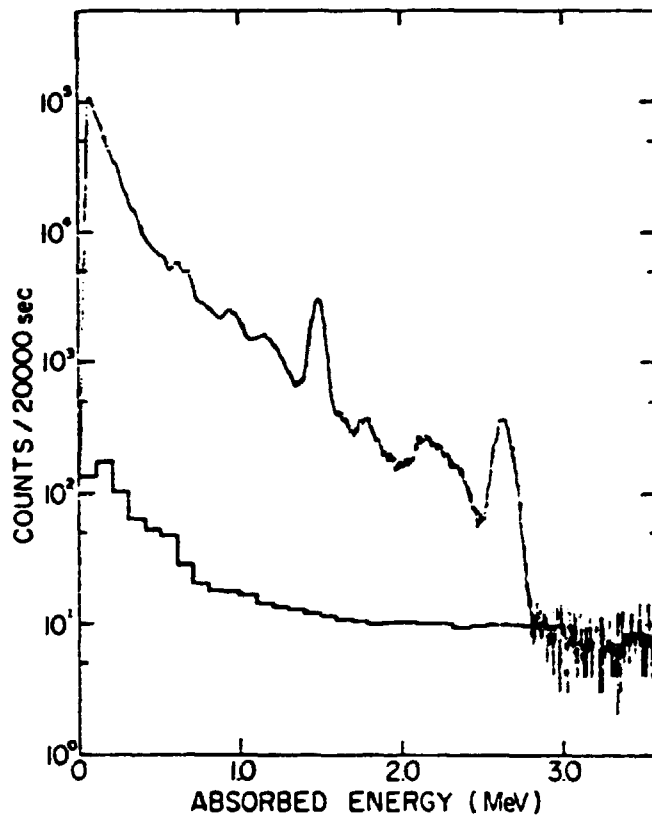

Fig. 17. Pulse-height distributions from cosmic-rays and from gamma-rays in the natural environment¹⁵).

This equation might be rewritten into a matrix equation as follows:

$$\underline{C} = \underline{R} \times \underline{N} \Rightarrow \begin{Bmatrix} c_1 \\ c_2 \\ \cdot \\ \cdot \\ c_k \end{Bmatrix} = \begin{Bmatrix} r_{11} & r_{12} & \dots & r_{1k} \\ & r_{21} & & \\ & \cdot & & \\ & \cdot & & \\ r_{k1} & \dots & \dots & r_{kk} \end{Bmatrix} \times \begin{Bmatrix} n_1 \\ n_2 \\ \cdot \\ \cdot \\ n_k \end{Bmatrix} \quad (2)$$

k : energy intervals

The unknown spectrum \underline{N} can be obtained by multiplication with the inverse matrix R^{-1} from the left in Eq.(2). This method is very useful for nearly monotonous spectra, but not for spectra with peaks, because the calculated spectra might oscillate and contain negative values.

For this reason we have calculated \underline{N} by an iterative method¹⁵⁾. The part of the incident true spectrum \underline{N} in the i^{th} energy interval after i iterations is given by:

$$n_i^{(j)} = n_i^{(j-1)} * c_i^{(0)} / c_i^{(j-1)} \quad (3)$$

with the following notation:

$n_i^{(j)}$: i^{th} energy-interval part of the true spectrum $\underline{N}^{(j)}$ after j iterations

$c_i^{(0)}$: i^{th} energy-interval part of the measured pulse-height spectrum

$c_i^{(j-1)}$: i^{th} element of the column vector \underline{C} calculated from Eq.(2) using the spectrum from the $(j-1)^{\text{th}}$ iteration $\underline{N}^{(j-1)}$

An initial spectrum $\underline{N}^{(0)}$ is necessary for the calculation, and the measured pulse height spectrum $\underline{C}^{(0)}$ was used. We divided the energy range from 0 to 3 MeV into 30 intervals of equal size.

Consequently the dimensions of \underline{C} , \underline{R} , and \underline{N} are 30, 30 x 30, and 30, respectively. Satisfactory convergence might be brought about after several iterations. The number of 50 iterations was sufficient to analyze the NaI(Tl) spectra.

The response matrix used in this study was calculated for a 3"x3" NaI(Tl) scintillator. A small correction of the efficiency for the response matrix was made for the assumption of an isotropic gamma-ray field¹⁶⁾. Since the response matrix was made for a bare NaI(Tl) scintillator, it was insufficient for a detector covered with metal. To solve this problem an additional response matrix which compensates for attenuation and scatter by a 4 mm Al cover was used¹⁷⁾.

The dose rate and dose-rate spectrum are given as follows:

$$D = \sum D_i \quad (4)$$

$$D_i = 0.0087 * 1.72 * \frac{N_i * E_{mi} * \mu_i * L}{V * W * T}$$

where

- D : dose rate in air ($\mu\text{Gy/h}$)
- D_i : dose rate at gamma-ray energy E_{mi} ($\mu\text{Gy/h}$)
- 0.0087: conversion factor from $\mu\text{R/h}$ to $\mu\text{Gy/h}$
- 1.72 : conversion factor to unit of $\mu\text{R/h}$
- N_i : number of incident gamma-rays in the i^{th} energy interval
- E_{mi} : mean energy of i^{th} energy interval (MeV)
- μ_i : energy absorption coefficient of air (1/cm)
- L : effective length of the NaI(Tl) scintillator (cm)
- V : volume of the NaI(Tl) scintillator (cm^3)
- W : W value of air (MeV/ion pair)
- T : measuring time (s)

N_i is calculated from Eq(3). L is the average length of the paths along which the gamma-rays pass through the scintillator in an

isotropic field. The values of L, V, and W are 5.8 cm, 347.5 cm² and 33.7 eV, respectively.

A sample analysis was made using a pulse-height distribution measured on a grass field at Risø National Laboratory. Figure 18 shows the measured pulse-height distribution and the calculated true gamma-ray spectrum. The 1460.7 keV peak of K-40 and 2614.5 keV peak of Tl-208 are more pronounced in the true energy spectrum than in the measured pulse height spectrum. The dose distribution calculated by the response matrix method is shown in Fig. 14 (right). The dose distribution was calculated assuming a uniform intensity within each energy interval on a linear scale; for example, all the logarithmic energy intervals from 10 to 100 keV were calculated from one energy interval on the linear scale.

2.3.3 G-function method

The G-function is used to convert the measured pulse height spectrum to dose directly.

The G-function method was developed by S. Moriuchi¹⁸⁾. The method is widely adapted in Japan using an electronic device to improve the strong energy dependence of the NaI(Tl) scintillator for the purpose of continuous measurements. As the theory of the G-function method is described in detail elsewhere¹⁸⁾, only a brief explanation is given here.

The dose rate is written as follows:

$$D = 0.0087 * \int_0^{\infty} C(E) * G(E) dE \quad (1)$$

where

- D : Dose rate (μ Gy/h)
- 0.0087: conversion factor from μ R/h to μ G/h
- C(E) : count rate at energy E of pulse-height spectrum (cpm)
- G(E) : value of G-function at energy E (μ R/h/cpm)

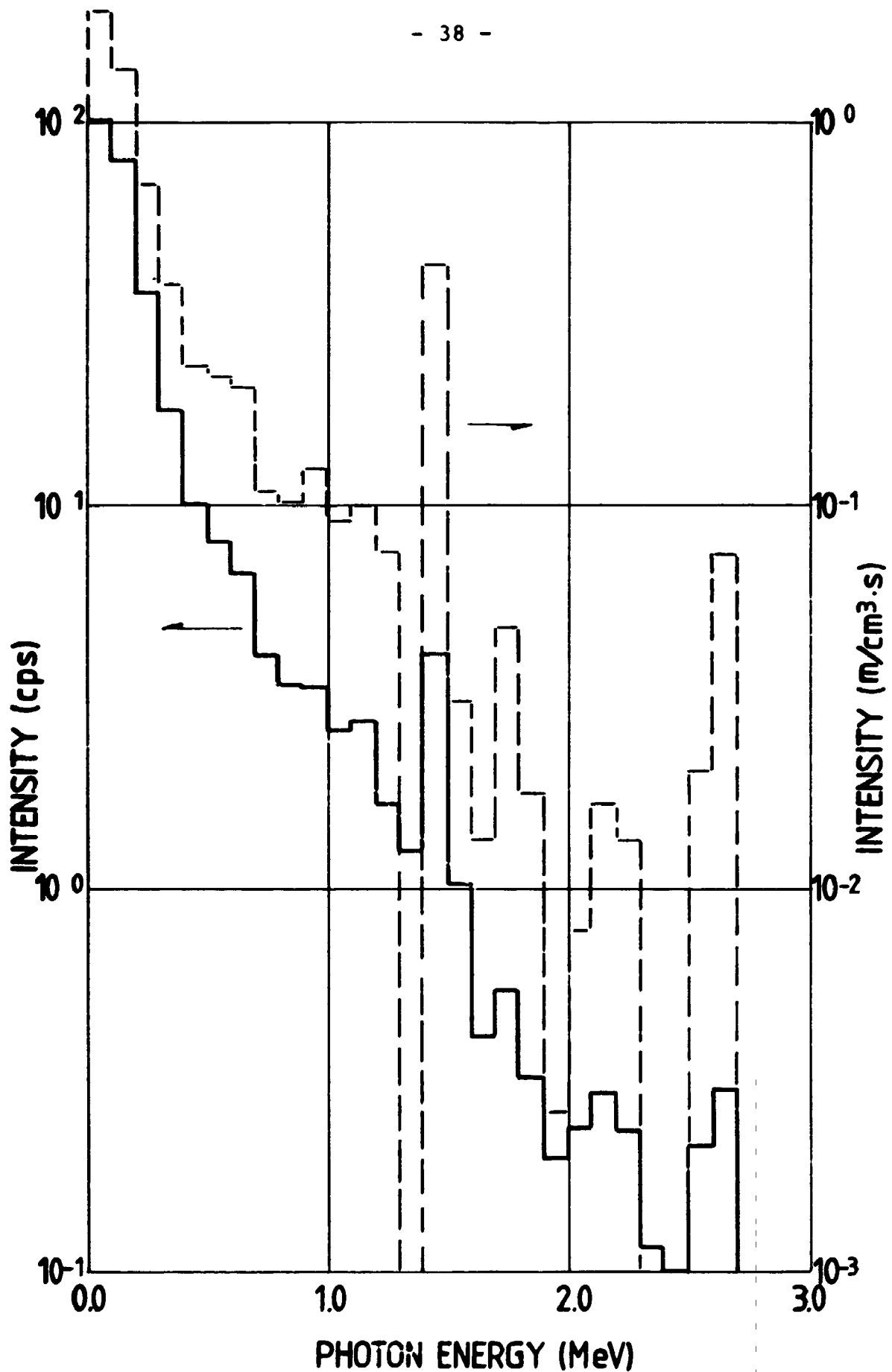

Fig. 18. Measured pulse-height distribution (solid line) and calculated true gamma-ray flux (dotted line) by response matrix method with NaI(Tl) detector at a lawn field.

In the present study doses were calculated from the measured pulse-height spectra which were divided into 10 keV intervals from 50 keV to 3 MeV. A table for the G(E)-function for 3"x3" NaI(Tl) scintillator was used¹⁹⁾.

2.4. High-pressure ionization chamber

Two high-pressure ionization chambers²⁰⁾ RSS-111 made by Reuter Stokes, were used to measure the total exposure. The shape of the chamber is spherical and the wall is made of 0.12" thick 303 stainless steel, in which high-pressure (25 atmospheres) high-purity Ar is filled. The ionization current is measured by an electrometer calibrated in $\mu\text{R}/\text{h}$. Instantaneous exposure rates were sampled every 40 seconds, and average one-hour exposure rates were calculated and stored by a datalogger. Finally, the collected data were transferred to a large computer, where, doses were calculated and plots were made.

The ionization-chamber response of $4.1\mu\text{R}/\text{h}$ to the cosmic-ray component was found from measurements at the nearby Roskilde Fiord. That value was subtracted from the recorded exposure rates in the field measurements.

2.5. Plastic scintillation dosimeter

The technique of the plastic scintillation dosimeter was developed by W.Kolb et al²¹⁾. In the present study the MAB 604 dosimeter was used to measure the gamma-ray dose rate. The detector consists of a NE102 plastic scintillator covered with ZnS(Ag) in order to improve the energy dependence.

Output is provided in analogue form from a rate meter and in digital form from the integrator. The latter which has a resolution of $0.1\mu\text{R}$ was used in connection with a stop watch to improve the precision of the results over that obtained when values are read visually from the rate meter.

3. MEASUREMENTS

3.1 Measurements of the cosmic-ray component

For TLD measurements of environmental gamma-rays it is necessary to subtract the contribution from the cosmic-ray component and the signal by self-contamination. For that purpose a measurement station was established on a pier at the Roskilde Fjord. Figure 19 shows the cosmic-ray measurement set-up. A multi-element TLD was placed together with LIF TLD in an open lead shield with a thickness of 100 mm thereby avoiding the terrestrial gamma-ray component. The shield was covered with a thin plastic plate.

Since most of the secondary cosmic-ray particles have high energies, the TLD's do not show a strong angular dependence to the cosmic-ray component. The dominant part of the cosmic-ray component consists of muons and electrons, and their angles of incidence at ground level are known as cosine distributions to powers of about two and three, respectively. Consequently the main part of the cosmic-ray component is measured by this method.

The lead shield also allowed for measurements with the NaI(Tl) spectrometer to assess the small contribution of gamma radiation from airborne radon daughters and the scattered terrestrial sky-shine component. The measured TLD signals were corrected for these small gamma-ray components calculated from the measured NaI(Tl) spectrometer results and the TLD energy response curves.

3.2 Source irradiations

Irradiation measurements were carried out using Ra-226 and Xe-133 gamma-ray sources in a basement room. The Ra-226 source simulated a typical natural radiation field, and the Xe-133 source an artificial field after an accidental release from a nuclear power plant. The source strengths were 1 mg of Ra-226 in a Pt,Ir-encap-

sulation and approximately 100 mCi of Xe-133 contained in a glass ampule. The distance between source and TL dosimeters was 40 cm. The set-up is shown in Fig.20. The irradiation periods were 17 days for Ra-226 and three days for Xe-133. The doses for both sources were calibrated by reference TL dosimeters (LiF: Dy). For the Ra-226 irradiation NaI(Tl) spectroscopy was carried out to get information on the gamma-ray energy distribution, and furthermore a measurement with the high-pressure ionization chamber was made.

3.3. Natural-field measurements

Measurements in the field were carried out at three locations. One was a normal low-background field near the Risø Test Station for Windmills, and the others were high-background fields, one near an uranium ore deposit and the other at the Risø waste treatment plant. The uranium-ore field was chosen as a typical high-background area because of the natural radiation sources present, and the waste treatment plant was chosen because of the increased radiation level present from low-energy scattered radiation from the facility. The TL dosimeters were mounted approximately one meter above ground fixed vertically on wooden plates for almost three months. The Figures 21 to 23 show each measuring place.

Several additional measurements were made at these locations with NaI(Tl) spectroscopy, high-pressure ionization chamber, and plastic scintillation dosimeter. These measurements were carried out twice during the TLD measurement. In order to know the variations of dose rates, continuous measurements with the high-pressure ionization chambers were made to cover the TLD integration time as accurately as could be done at the waste treatment plant and the Test Station for Windmills. Measurements with LiF: Dy TL dosimeters were made for the high-background places only because of the lower sensitivity of these dosimeters.

4. RESULTS AND DISCUSSION

Results from the field sites and from the source irradiations of the measurements with the multi-element TL dosimeters are shown

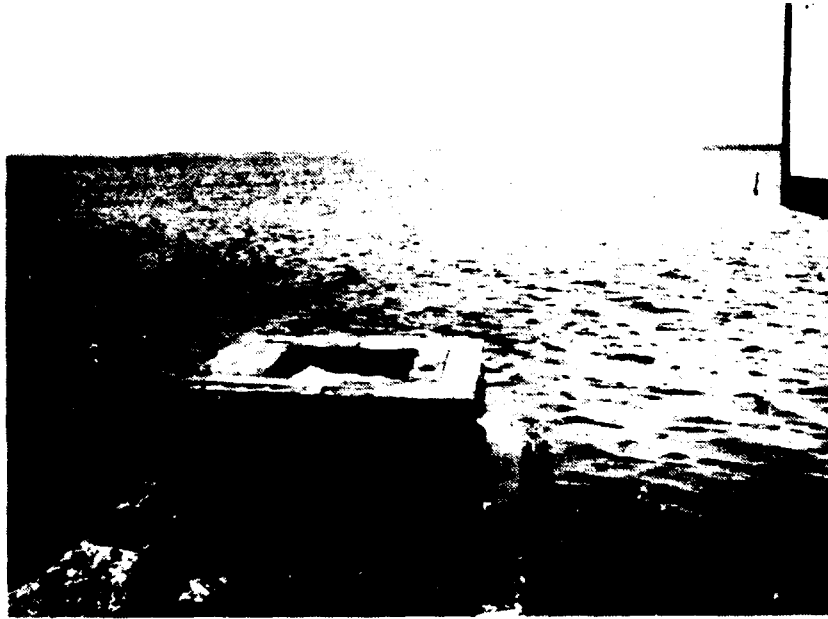

Fig. 19. Cosmic-ray measurement set-up.

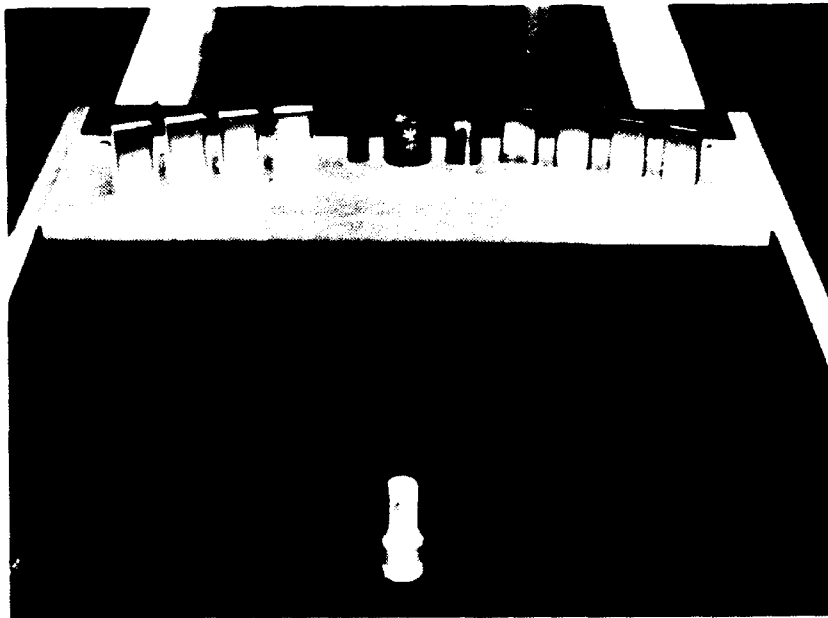

Fig. 20. Source irradiation set-up.



Fig. 21. Low background field site at windmill test station.

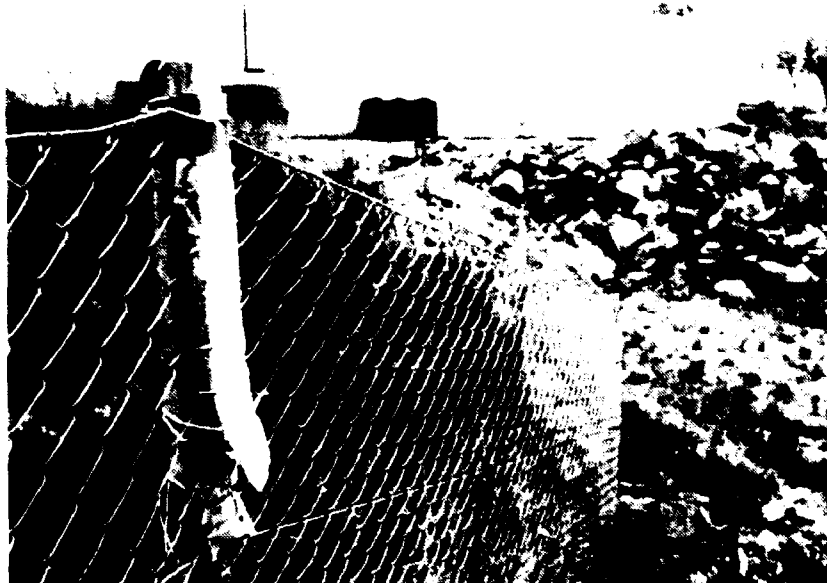

Fig. 22. Field site at uranium ore deposit.



Fig. 23. Field site at waste treatment plant.

in Table 5. These data are used as input to the SAND II code. The results of the calculated dose-rate spectra are shown in Figs. 24 to 28, which also include spectra obtained from the NaI(Tl) Response matrix method. For the Xe-133 irradiation there are no data from the NaI(Tl) response matrix method because of the limited energy resolution (100 keV) for that method. Fairly good agreement was found between the two measured spectra at the high-dose rate fields, except for small differences due to the low background field in Figure 26, a slight difference between the two shapes can be seen. The present multi-element TLD technique poses special problems in a low-background field, because the cosmic-ray component is relatively large compared to the gamma-ray component, especially for those TLD elements that are shielded most. Furthermore, the subtracted gamma-ray component may contain some errors.

The dose rates measured with multi-element $\text{CaSO}_4:\text{Dy}$ TL dosimeters, $\text{LiF}:\text{Dy}$ TL dosimeters, the NaI(Tl) spectrometer, high-pressure ionization chamber, and plastic scintillation dosimeter are presented in Table 6. A quite good agreement is seen for the doses of Ra-226 irradiation. However, there is a large difference between the results from the multi-element TLD and the LiF TLD for the Xe-133 irradiation. At present we have no explanation for this difference. Only a single measurement was possible due to the half-life of the source 5.29 days. Further experiments could be made in order to investigate whether or not there is a contribution of low-energy X-rays (from 30 keV to 35 keV) from Xe-133 which gives a low response for the LiF TL dosimeter.

For the field measurements made with the multi-element TLD's and LiF TLD's the cosmic-ray components measured at the pier were subtracted. And for the doses measured with the other detectors the cosmic-ray components were also subtracted. The environmental dose rates measured with the multi-element TL dosimeters at the field sites are generally consistent with those measured by the other methods.

At the low-background site and waste treatment plant, the continuous measurements with high-pressure ionization chambers were

Table 5. Measured CaSO₄:Dy TLD signal (μ Gy/h) for each element normalized by Co-60 radiation from Ra-226 and Xe-133 source irradiations, the three environmental field sites, and cosmic-ray measurement station.

	CaSO ₄ :Dy TLD signal				
	Al-1mm	Cu-1mm	Cu-6mm	Pb-2mm	Pb-10mm
Ra-226 irradiation	1.10	1.06	0.958	0.886	0.769
Xe-133 irradiation	190.	25.3	1.11	0.364	0.886
Low background field site	0.0295	0.0259	0.0193	0.0156	0.0103
U-ore deposit field site	0.705	0.669	0.551	0.457	0.368
Waste treatment field site	1.29	0.872	0.408	0.186	0.0769
Cosmic-ray component	0.0358	0.0336	0.0377	0.0405	0.0632

The cosmic-ray component was subtracted for the measurements at the environmental sites.

Table 6. Dose rates ($\mu\text{Gy/h}$) evaluated from measurements with multi-element $\text{CaSO}_4\text{:DY}$ TL dosimeter of Ra-226 and Xe-133 gamma radiations, and the environmental gamma radiations at 3 different field sites. Comparative measurements made with LiF TLD, NaI(Tl) gamma spectrometer, RSS-111 high-pressure ionization chamber, and plastic scintillation dosimeter are listed as well.

	Multi-element TLD	LiF TLD	NaI(Tl) Matrix	NaI(Tl) G-function	RSS-111 HPIC	Plastic Scint.
Ra-226 source	0.983	1.00	1.04	1.01	0.992	-
Xe-133 source	35.3	22.2	-	-	-	-
Lcw background field site	0.0214	-	0.0225	0.0211	0.0289	0.0300
U-ore deposit field site	0.576	0.586	0.545	0.522	0.609	0.524
Waste treatment field site	0.574	0.614	0.566	0.478	0.641	0.505

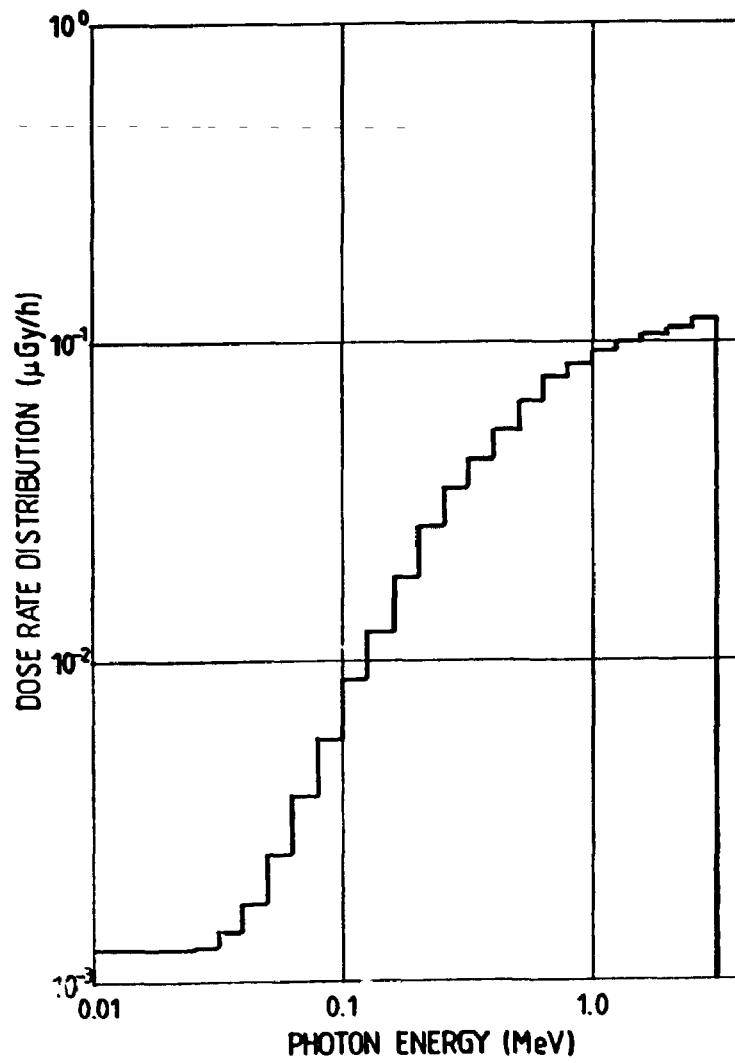

TLD

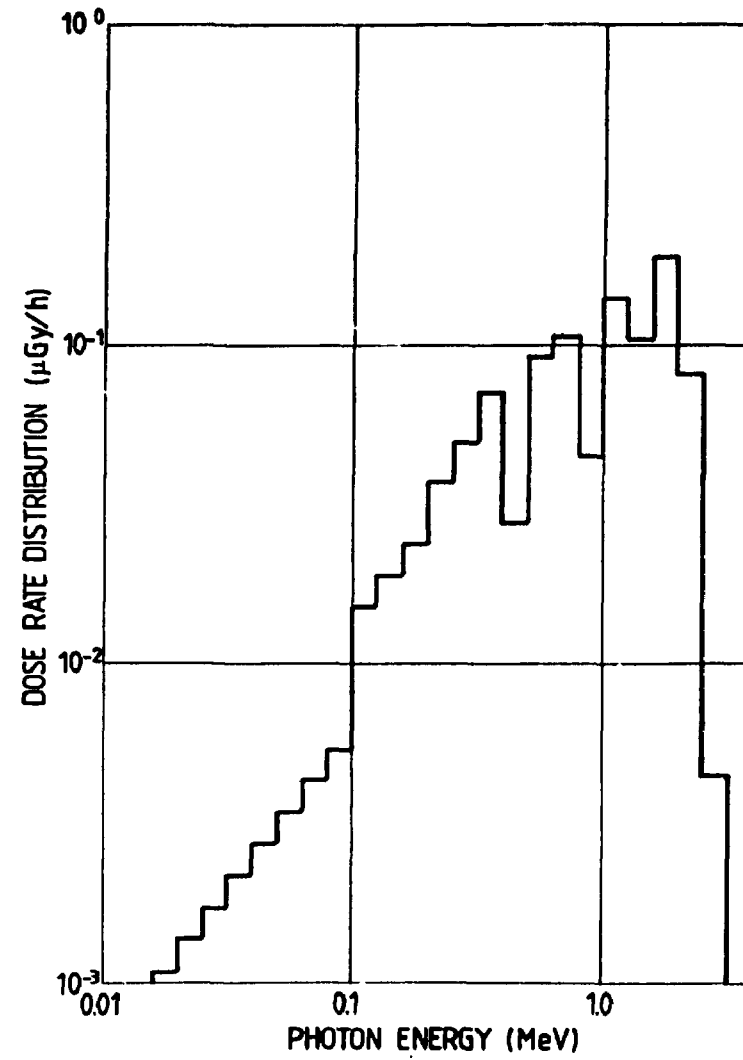

NaI

Fig. 24. Dose rate spectra for the Ra-226 irradiation obtained from the multi-element TLD system (left) and the NaI(Tl) response matrix method (right).

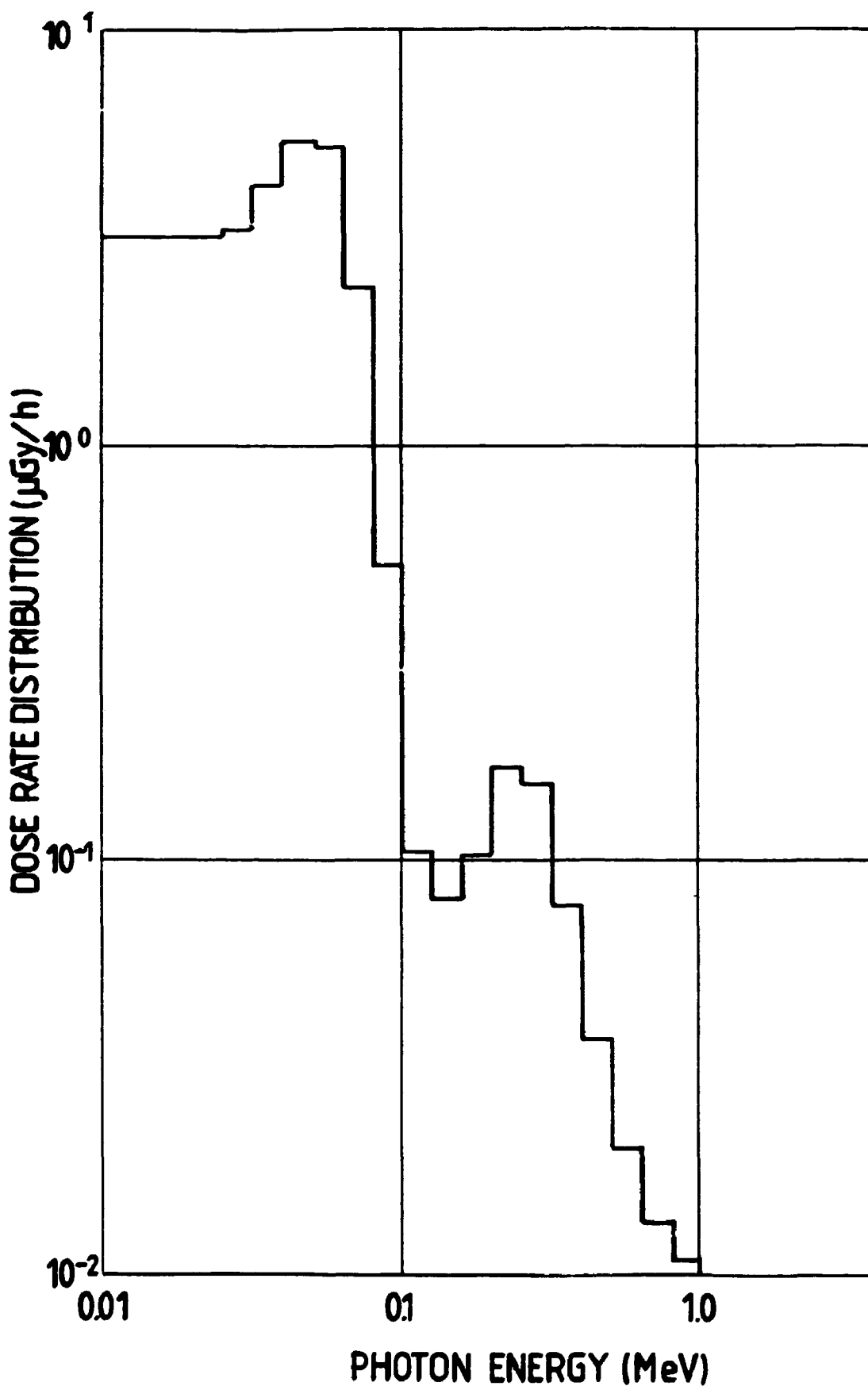
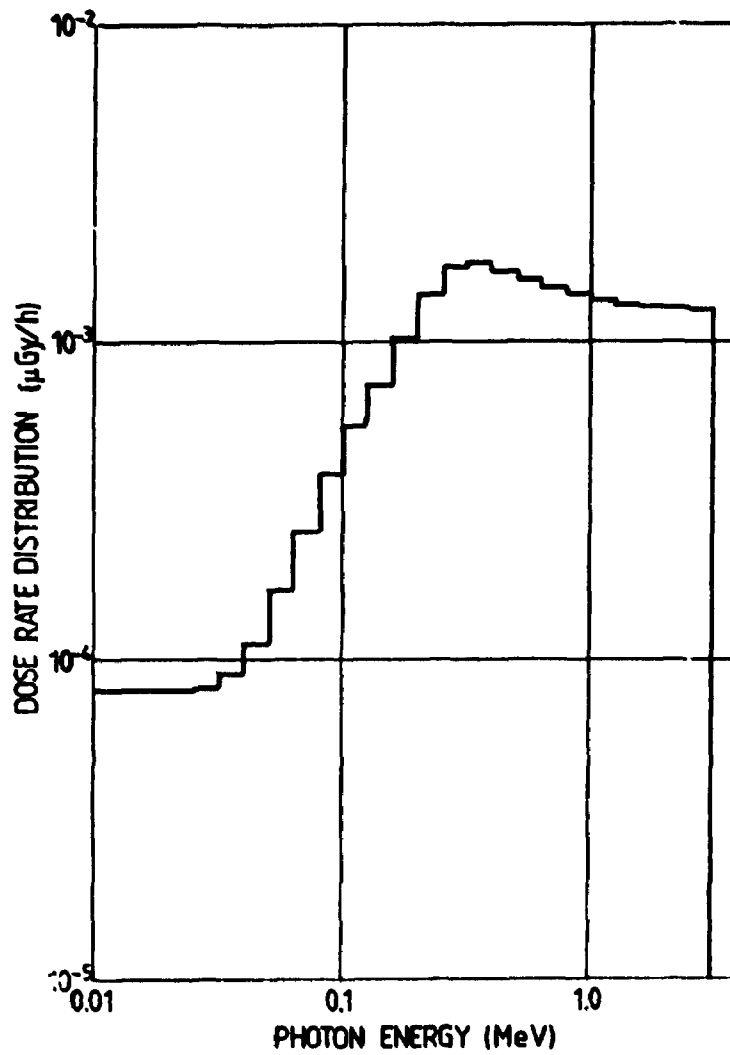
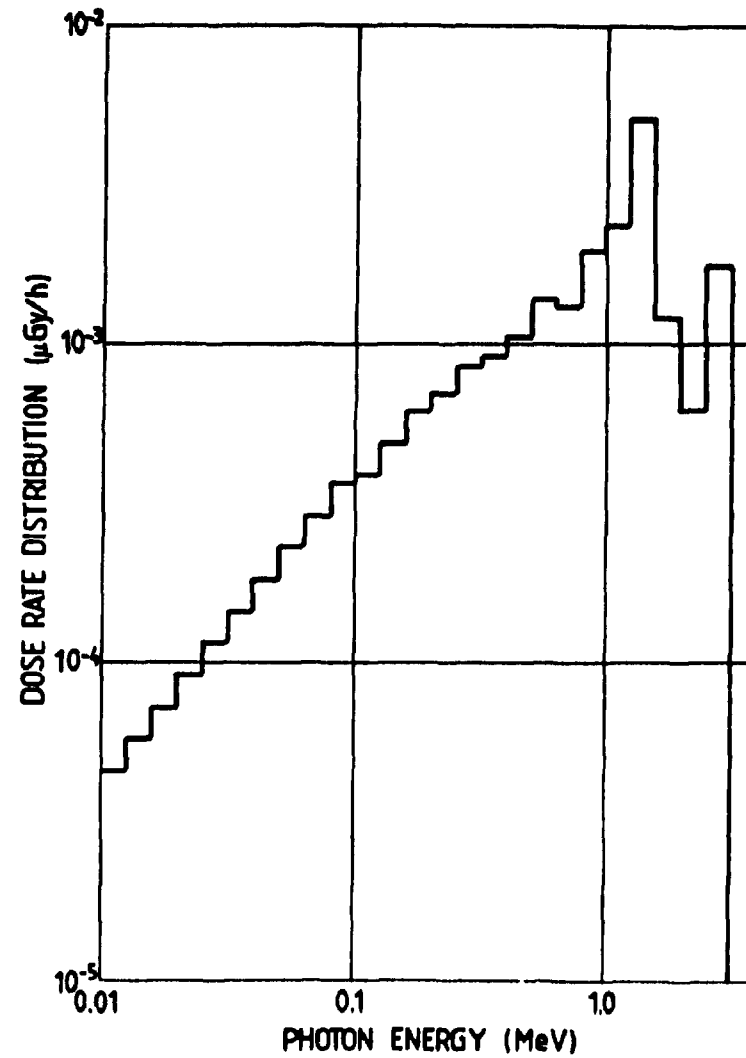

Fig. 25. Dose rate spectrum for the Xe-133 irradiation obtained from the multi-element TLD system.



TLD



NaI

Fig. 26. Dose rate spectra at the low background field site obtained from the multi-element TLD system (left) and the NaI(Tl) response matrix method (right).

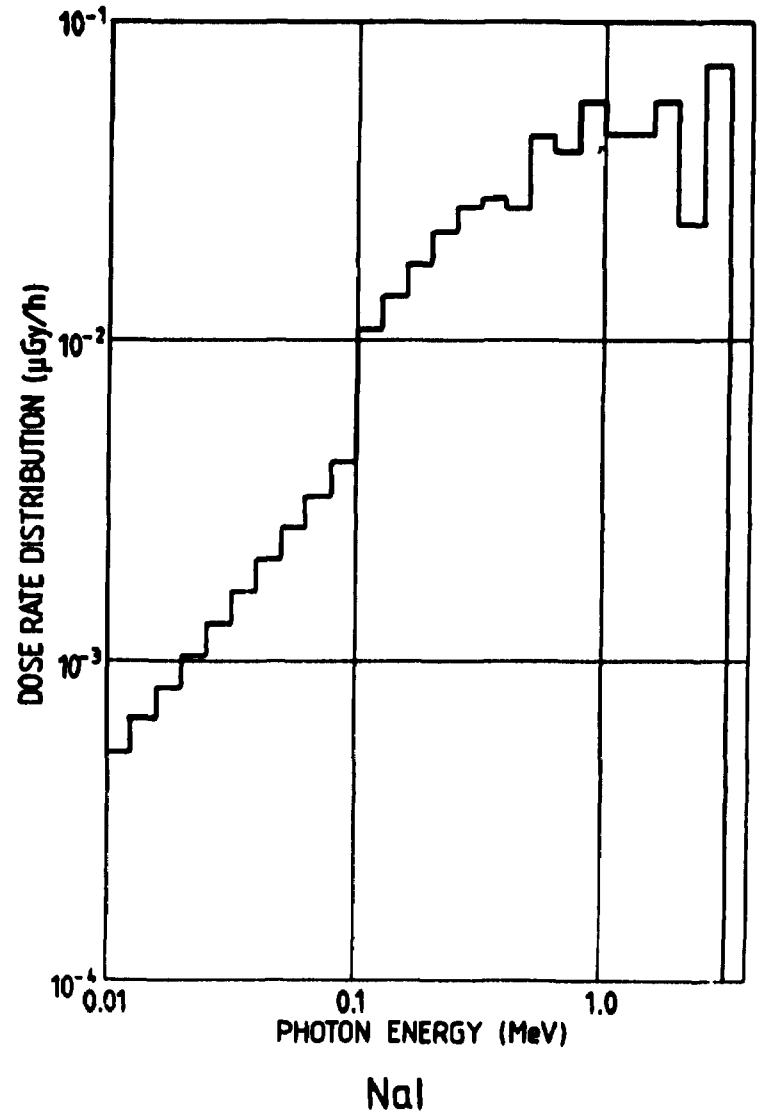
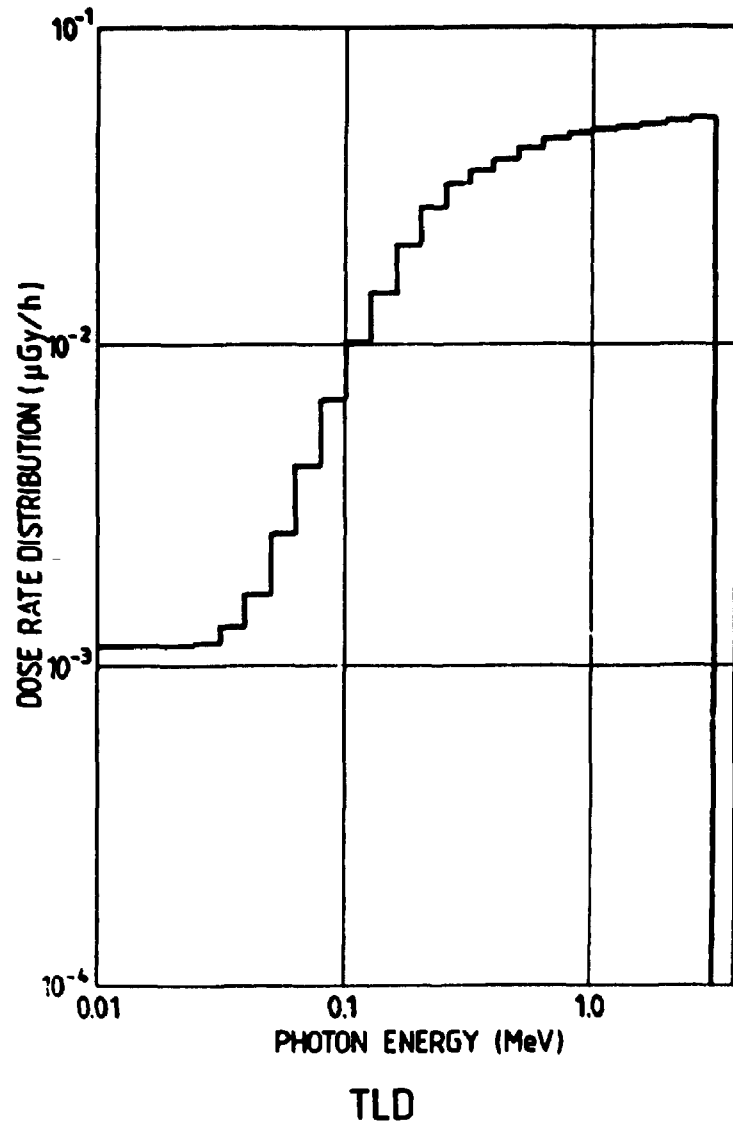
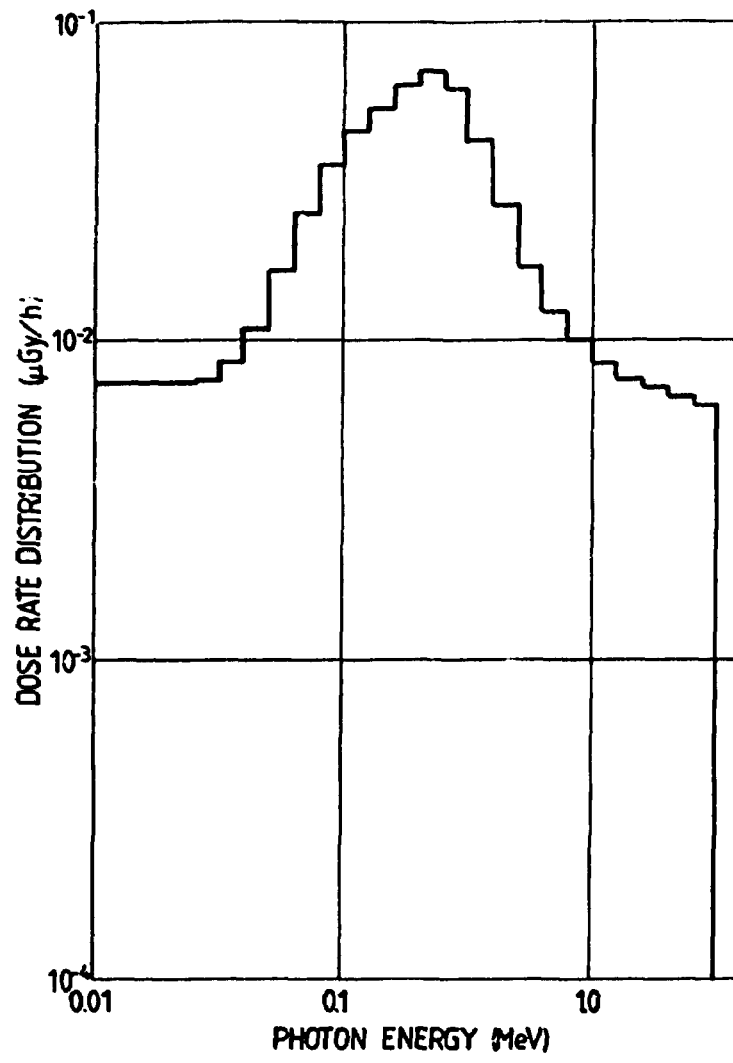
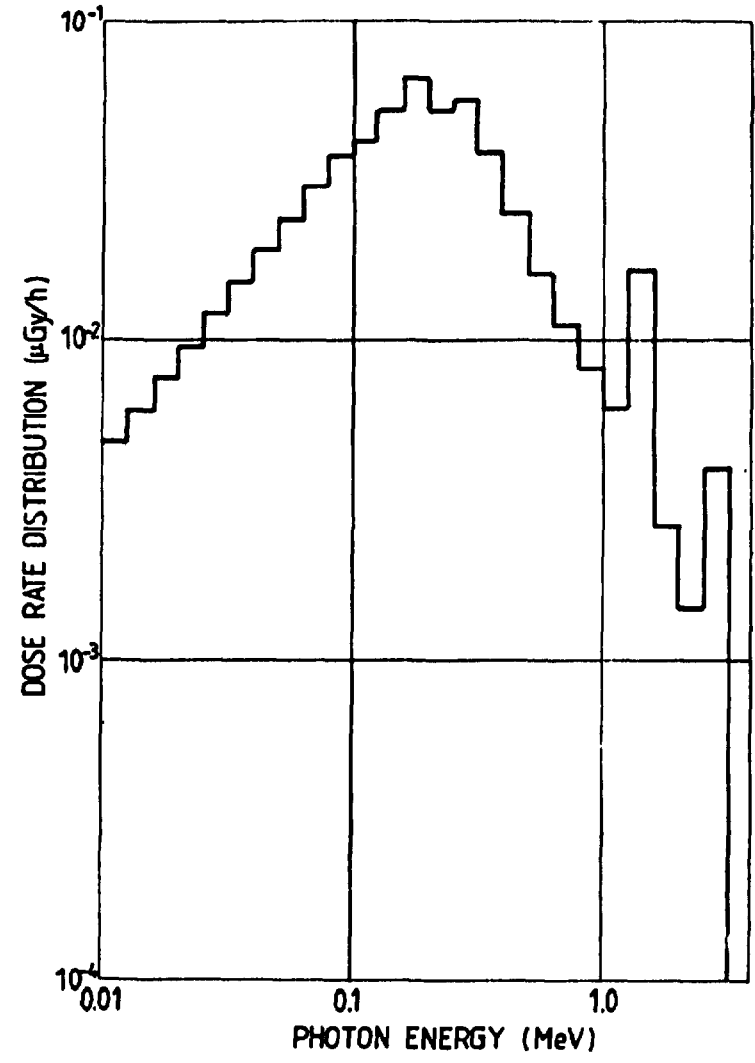

Fig. 27. Dose rate spectra at the uranium ore deposit field site obtained from the multi-element TLD system (left) and the NaI(Tl) response matrix method (right).



TLD



NaI

Fig 28. Dose rate spectra at the waste treatment plant field site obtained from the multi-element TLD system (left) and the NaI(Tl) response matrix method (right).

made simultaneously, and average dose rates were calculated. Figure 29 shows the dose rates measured at the two sites. During the TLD measurements, there was a significant change in the dose rate at the waste treatment plant. The data for the NaI(Tl) spectrometry and plastic scintillation measurements made on 3 May were corrected assuming that the normalized gamma-ray energy spectra were identical before and after the change of the dose rate level. The other data of point measurements presented in the table were measured on 5 May. Another significant change occurs because of the fallout from the Chernobyl nuclear power plant accident. But the contribution to the accumulated TL dose is small.

We have made no evaluation of the angular dependence of the multi-element TL dosimeter. This dependence may be of significance at the low energy range. For the source irradiations the angular dependence is unimportant because the geometric conditions were the same as for the energy response calibrations. For the environmental field measurements the importance of the angular dependence is rather difficult to evaluate. The multi-element TLD's were positioned vertically for the field measurements because the dominant direction of gamma-rays in the environment at 1 meter above ground is close to horizontal.

The present study did not allow for the calculation of error estimates because the evaluations of the multi-element TLD technique and the NaI(Tl) response matrix method were based on iterative methods. Error estimates might be obtained from the computer codes such as the modified SAND-II Monte Carlo code²²⁾, NEUPAC²³⁾, STAY'SL²⁴⁾, and FERRET²⁵⁾. The most basic SAND-II code was adapted for the present study, as a first attempt to apply this technique to the multi-element TL dosimeter.

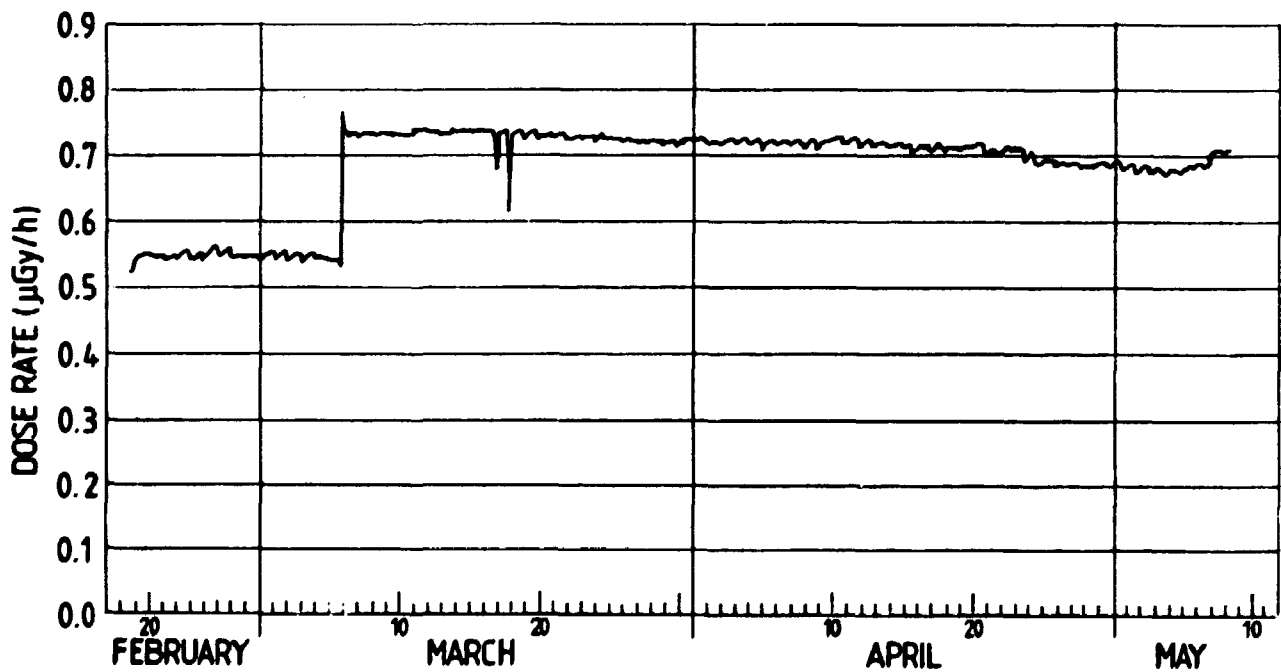
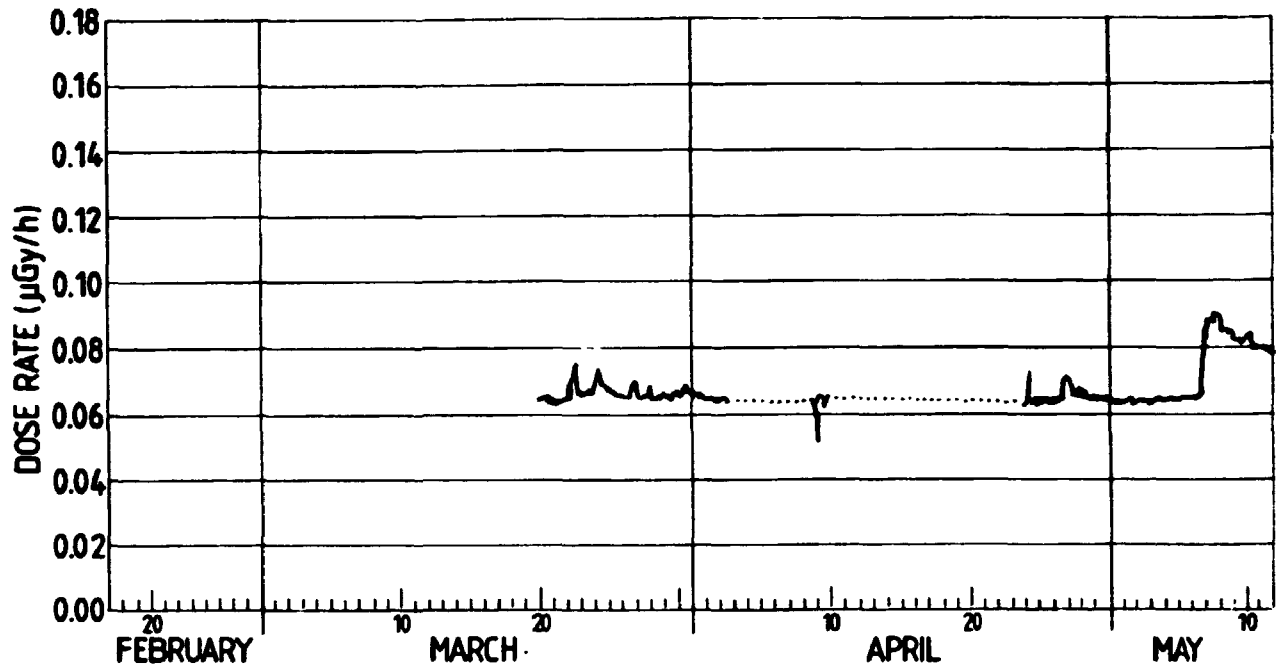

Fig. 29. Dose rates measured with high-pressure ionization chambers at the low-background field site (upper) and the waste treatment plant (lower).

5. CONCLUSION

A passive environmental TL dosimeter system that estimates the gamma-ray energy distribution and the dose has been developed on the basis of the SAND-II computer code and a five-element CaSO₄:Dy TLD equipped with different filters. A test monitoring program made in this study has shown that the doses and unfolded gamma-ray spectra can be obtained with the dosimeter with results that makes the system attractive for measuring environmental gamma radiation on a routine basis. Further attempts will be necessary in order that the system be used routinely with the evaluation of error estimates.

The TLD system might be considered for future use in connection with environmental monitoring around nuclear facilities due to the low cost, high sensitivity, and the information given by this system compared to alternatives available currently.

ACKNOWLEDGMENTS

The authors wish to thank Dr. Klaus Ennow for carrying out the multielement TLD X-ray energy calibrations.

REFERENCES

1. PUIITE, K.J. and CREBOLDER, D.L.J.M. (1978), Measurement of Beam Quality and Absorbed Dose using a Two-Phosphor System. Technical Reports Series No.182, IAEA, Vienna, pp. 123.
2. ROSSITER, M.J. and WOOD, J.W., (1978). The Dual-Phosphor System for Assessment of X-ray Beam Quality During TLD Inter-comparison. Technical Reports Series No.182, IAEA, Vienna, pp. 171.
3. NAKAJIMA, T. and CHIBA, M., (March 1986). Evaluating Method of Effective Energy of Radiation due to Thermoluminescence Dosimeter. J. of Nucle. Sci. and Techn., Vol.23 (3) pp. 258.
4. MOMOSHIMA, N., MATSUOKA, N., KAJI, T., OKAI, T., OKAMURA, M., NAKASHIMA, T., TAKASHIMA, Y., and SHIRAISHI, N., (1985). Environmental Xe-133 radiation Monitoring Method by Thermoluminescence Dosimeters after Accidental Release from Nuclear Power Plant. J. of Atomic Energy Society of Japan, Vol.27 No.9, pp. 95.
5. BERG, S. and McElroy, W.N., (September 1967). A Computer-automated Iterative Method for Neutron Flux Spectra Determination by Foil Activation - SAND II and Associated Codes, AFWL-TR-67-41, Vols. I through IV.
6. BERG, S., (August 1968). Modification of SAND II, BNWL-855.
7. NAKAMURA, T., KOSAKO, T., and HAYASHI, K., (1981), A Systematic Study on Neutron Shyshine from Nuclear Facilities - Part II. Experimental Approach to the Behavior of Environmental Neutrons Around an Electron Synchrotron, Nucl. Sci. Eng., 77, pp. 182.
8. KOSAKO, T., MATSUMOTO, J., NAKAZAWA, M., and SEKIGUCHI, A., (1985). Proc. 20th. Conference, Japan Health Physics Society, Kyoto, pp. 3.
9. PROKIC, M.S., (1982). New Sintered Thermoluminescent Dosimeters for Personal and Environmental Dosimetry, Health physics, Vol.42 No.6, pp. 849.

10. EØTTER-JENSEN, L., CHRISTENSEN P., and MAJBORN, B., (1974). A TLD Personnel Monitoring System with Automatic Processing, Proc. 3rd. Int Congr., IRPA, Washington, pp. 572.
11. Method of environmental gamma-ray Dose Measurement Using Thermoluminescence dosimeter, Radioactivity Measurement Method Series 18, Science and Technology Agency of Japan (1982).
12. SEELENTAG, W.W., PANZER, W., DREXLER, G., PLATZ, F., and SANTNER, F., (March 1979). A Catalogue of Spectra used for the Calibration of Dosimeters, Gesellschaft für Strahlen- und Umweltforschung mbH München, Institut für Strahlenschutz, GSF-Bericht S 560.
13. ENNOW, K., Calibration of Ionization Chambers at the Nordic SSDL's, to be published.
14. URABE, I. and KATSURAYAMA, K., (1979). Free-air Ionization Intensity in the Lower Atmosphere Due to Cosmic-ray, Hoken Butsuri (J. of the Japan Health Physics Society), Vol.14, pp. 151.
15. MINATO, S. and KAWANO, M. (August 1970). Evaluation of Exposure due to Terrestrial Gamma-Radiation by Response Matrix Method, J. of Nuclear Science and Technology, 7(8), pp. 401.
16. BERGER, M.J. and SELTZER, S.M., (1972). Response Functions for Sodium Iodide Scintillation Detectors, Nucl. Inst. and Meth., 104, pp. 317.
17. URABE, I., YOSHIMOTO, T., TSUJIMOTO, T., KATSURAYMA, K., and NAKASHIMA Y. (1982). Development of Correction Method for Gamma-ray Energy Spectra Modified by Protection Cases of a NaI(Tl) Scintillation Detector Employed for Environmental Radiation Monitoring, Hoken Butsuri (J. of the Japan Health Physics Society), Vol.17, pp. 11.
18. MORIUCHI, S. and MIYANAGA, I. (1966). A Spectrometric Method for Measurement of Low-level Gamma Exposure Dose, Health Physics, Vol.12, pp. 541.
19. MORIUCHI, S. (July 1971). A New Method of Dose Evaluation by Spectrum-Dose Conversion Operator and Determination of the Operator, JAERI Report 1209.
20. DECAMPO, J.A., Beck, H.L., and RAFT P.D. (December 1972). High Pressure Argon Ionization Chamber Systems for the Measurement of Environmental Radiation Exposure Rates, HASL-260.

21. KOLB, W. and LAUTERBACH, U. (August 1972). A Scintillation Exposure Rate Meter for Environmental Radiation Surveys, The Natural Radiation Environment II, pp. 245.
22. OSTER, C.A., McELROY, W.N., SIMONS, R.L., LIPPINCOTT, E.P., and ODETTE, G.R. (August 1976). A Modified Monte Carlo Program For SAND-II with Solution Weighting and Error Analysis, HEDEL-TIME 76-60, UC-79b.
23. NAKAZAWA, M. and SEKIGUCHI, A. (1977). NUREG/CP-0004,3,1423.
24. PEREY, F.G. (October 1977) Least-squares Dosimetry Unfolding: The program STAY'SL, ORNL/TM-6062, ENDF-254.
25. SCHMITTROTH, F. (September 1979). FERRET Data Analysis Code, HEDL-TME 79-40, UC-79, 79d.

Title and author(s) MEASUREMENTS OF ENVIRONMENTAL GAMMA-RAY SPECTRA USING A MULTI-ELEMENT TL DOSEMETER Sadaaki Furuta*, Lars Bøtter-Jensen and Sven P. Nielsen * Health and Safety Division, Oarai Engineering Center, Power Reactor and Nuclear Fuel Development Corporation; Oari-machi, Higashi-Ibaraki-gun, Ibaraki-ken, Japan.	Date December 1986
	Department or group Health Physics
	Groups own registration number(s)
	Project/contract no.
Pages 59 Tables 6 Illustrations 29 References 25	ISBN 87-550-1313-9

Abstract (Max. 2000 char.)

A method to estimate the energy distribution and dose of environmental gamma radiation was developed using a multielement TL dosimeter. Experimentally obtained energy responses from a multi-element TL dosimeter with different kinds of filters were used to calculate the energy distribution and related dose by the SAND-II computer code. The code was originally developed to estimate the neutron flux using a multiple foil activation method. Measurements were made at several locations with the multi-element TL dosimeter and comparisons were made with results from a NaI(Tl) scintillation detector and a high-pressure ionization chamber.

Descriptors - INIS

CALCIUM SULFATES; CALIBRATION; COMPARATIVE EVALUATIONS; COMPUTER CALCULATIONS; DOPED MATERIALS; DYSPROSIUM; ENERGY DISTRIBUTION; ENVIRONMENT; FILTERS; GAMMA SPECTRA; S CODES; THERMOLUMINESCENT DOSEMETERS