



## Genome and physiology of the ascomycete filamentous fungus *Xeromyces bisporus*, the most xerophilic organism isolated to date

Leong, Su-lin L.; Lantz, Henrik; Pettersson, Olga V.; Frisvad, Jens Christian; Thrane, Ulf; Heipieper, Hermann J.; Dijksterhuis, Jan; Grabherr, Manfred; Pettersson, Mats; Tellgren-Roth, Christian

Total number of authors:  
11

Published in:  
Environmental Microbiology

Link to article, DOI:  
[10.1111/1462-2920.12596](https://doi.org/10.1111/1462-2920.12596)

Publication date:  
2015

Document Version  
Publisher's PDF, also known as Version of record

[Link back to DTU Orbit](#)

### Citation (APA):

Leong, S. L., Lantz, H., Pettersson, O. V., Frisvad, J. C., Thrane, U., Heipieper, H. J., Dijksterhuis, J., Grabherr, M., Pettersson, M., Tellgren-Roth, C., & Schnürer, J. (2015). Genome and physiology of the ascomycete filamentous fungus *Xeromyces bisporus*, the most xerophilic organism isolated to date. *Environmental Microbiology*, 17(2), 496-513. <https://doi.org/10.1111/1462-2920.12596>

---

### General rights

Copyright and moral rights for the publications made accessible in the public portal are retained by the authors and/or other copyright owners and it is a condition of accessing publications that users recognise and abide by the legal requirements associated with these rights.

- Users may download and print one copy of any publication from the public portal for the purpose of private study or research.
- You may not further distribute the material or use it for any profit-making activity or commercial gain
- You may freely distribute the URL identifying the publication in the public portal

If you believe that this document breaches copyright please contact us providing details, and we will remove access to the work immediately and investigate your claim.

# Genome and physiology of the ascomycete filamentous fungus *Xeromyces bisporus*, the most xerophilic organism isolated to date

Su-lin L. Leong,<sup>1\*†</sup> Henrik Lantz,<sup>1,2†</sup>  
Olga V. Pettersson,<sup>1,3</sup> Jens C. Frisvad,<sup>4</sup> Ulf Thrane,<sup>4</sup>  
Hermann J. Heipieper,<sup>5</sup> Jan Dijksterhuis,<sup>6</sup>  
Manfred Grabherr,<sup>7</sup> Mats Pettersson,<sup>8</sup>  
Christian Tellgren-Roth<sup>3</sup> and Johan Schnürer<sup>1</sup>

<sup>1</sup>Department of Microbiology, Swedish University of Agricultural Sciences, Box 7025, SE-75007 Uppsala, Sweden.

Departments of <sup>2</sup>Medical Biochemistry and Microbiology/BILS and <sup>3</sup>Immunology, Genetics and Pathology, Uppsala Genome Center, and <sup>7</sup>Medical Biochemistry and Microbiology/Science for Life Laboratories, Uppsala University, Uppsala, Sweden.

<sup>4</sup>Department of Systems Biology, Technical University of Denmark, Kongens Lyngby, Denmark.

<sup>5</sup>Department of Environmental Biotechnology, Helmholtz Centre for Environmental Research–UFZ, Leipzig, Germany.

<sup>6</sup>CBS-KNAW Fungal Biodiversity Centre, Utrecht, The Netherlands.

<sup>8</sup>Division of Computational Genetics, Department of Clinical Sciences, Swedish University of Agricultural Sciences, Uppsala, Sweden.

## Summary

***Xeromyces bisporus* can grow on sugary substrates down to 0.61, an extremely low water activity. Its genome size is approximately 22 Mb. Gene clusters encoding for secondary metabolites were conspicuously absent; secondary metabolites were not detected experimentally. Thus, in its ‘dry’ but nutrient-rich environment, *X. bisporus* appears to have relinquished abilities for combative interactions. Elements to sense/signal osmotic stress, e.g. HogA pathway, were present in *X. bisporus*. However, transcriptomes at optimal (~ 0.89) versus low  $a_w$  (0.68) revealed differential expression of only a few stress-related**

genes; among these, certain (not all) steps for glycerol synthesis were upregulated. *Xeromyces bisporus* increased glycerol production during hypo- and hyper-osmotic stress, and much of its wet weight comprised water and rinsable solutes; leaked solutes may form a protective slime. *Xeromyces bisporus* and other food-borne moulds increased membrane fatty acid saturation as water activity decreased. Such modifications did not appear to be transcriptionally regulated in *X. bisporus*; however, genes modulating sterols, phospholipids and the cell wall were differentially expressed. *Xeromyces bisporus* was previously proposed to be a ‘chaophile’, preferring solutes that disorder biomolecular structures. Both *X. bisporus* and the closely related xerophile, *Xerochrysum xerophilum*, with low membrane unsaturation indices, could represent a phylogenetic cluster of ‘chaophiles’.

## Introduction

Water is an essential component of all active cells as it is the matrix in which cellular reactions occur. Availability of water can be limited by a low relative humidity, e.g. in hot, dry deserts, or when water is bound up in ice or by a high concentration of solutes (e.g. in salterns and at high sugar concentrations) (Williams and Hallsworth, 2009; Gostinčar *et al.*, 2010). Microorganisms have developed various strategies to grow in each of these conditions, and fungi are among those best adapted to growth when little water is available. *Xeromyces bisporus* is an ascomycete filamentous fungus that has the unique trait of being, arguably, the most xerophilic (‘dry-loving’) organism discovered to date (Pitt and Christian, 1968; Grant, 2004; Williams and Hallsworth, 2009; Leong *et al.*, 2011). Well-known desiccation-resistant organisms such as tardigrades and resurrection plants enter a cellular dormancy that is broken when cells are rehydrated; however, *X. bisporus* actively grows in conditions of decreased water availability. Indeed, it has an absolute requirement for lowered water availability in order to grow and has an optimal water activity for growth around 0.85 (where water activity,  $a_w$ , is defined as the vapour pressure of water

Received 30 April, 2014; accepted 14 August, 2014. \*For correspondence. E-mail Su-lin.Leong@slu.se; Tel. +46 18 67 3211; Fax +46 18 67 3393. †Su-lin L. Leong and Henrik Lantz contributed equally as first authors.

above a sample divided by that of pure water in the sample, pure water having  $a_w = 1$ ) (Grant, 2004). In this way, *X. bisporus* shares its preference for decreased water availability with other extremophiles, such as the halophilic microbiota of salterns (bacteria e.g. *Salinibacter ruber*, archaea e.g. *Haloquadratum walsbyi*, the alga *Dunaliella salina*, yeasts e.g. *Hortaea werneckii*; Ma *et al.*, 2010). But unlike the halophiles, *X. bisporus* prefers sugars or glycerol as a solute in the growth medium, and given such conditions can even grow at 0.61  $a_w$  (Pitt and Christian, 1968; Leong *et al.*, 2011), lower than any other organism reported to date. As a point of reference, 0.61  $a_w$  is roughly equivalent to an osmotic pressure on the fungal hyphae of  $-67$  MPa cf. the permanent wilting point of terrestrial plants at  $-1.5$  MPa (0.99  $a_w$ ). The majority of *X. bisporus* strains have been isolated from high-sugar foods, including dried fruits (Pitt and Hocking, 2009), and thus, wizened berries and fruits are likely to be the natural habitat for this fungus.

We sequenced and assembled the genome of *X. bisporus*, and annotated the genome carefully in order to gain insight into its xerophilic lifestyle. We also generated RNA-Seq data from two different conditions, namely optimal  $a_w$  ( $\sim 0.89$ ) versus low, stressed  $a_w$  (0.68). We interrogate these data from two perspectives: potential for interaction of the extremophile, *X. bisporus*, with other extremophiles in its environment via production of

**Table 1.** Genome assembly (including the mitochondrion).

NEWBLER estimated genome size	24.8 Mb
Size of assembly	22.0 Mb
Assembly scaffold N50 size	441 kb
Assembly contig N50 size	50 675
Number of scaffolds	184
Number of contigs	2449
Number of contigs in scaffolds	1217
CEGMA reported completeness	93.6% proteins complete (232/248)
GC-content (not counting Ns)	49.6%
Number of gene loci <sup>a</sup>	10 062

a. As estimated by CUFFLINKS.

secondary metabolites; and physiological responses of *X. bisporus* to growth in conditions of extreme low-water stress.

## Results and discussion

Taxonomically, *X. bisporus* is placed in *Eurotiales*, in which a number of other species are also xerophiles (Pettersson *et al.*, 2011). The size of the assembly (22 Mb; Table 1) is comparable with other closely related species (Fig. 1). The k-mer based estimate of true genome size reported by the assembly software (NEWBLER 2.5; Roche Diagnostics Corporation) is slightly larger at 24.8 Mb. One method of assessing the quality of the assembly is to use CEGMA to search for genes

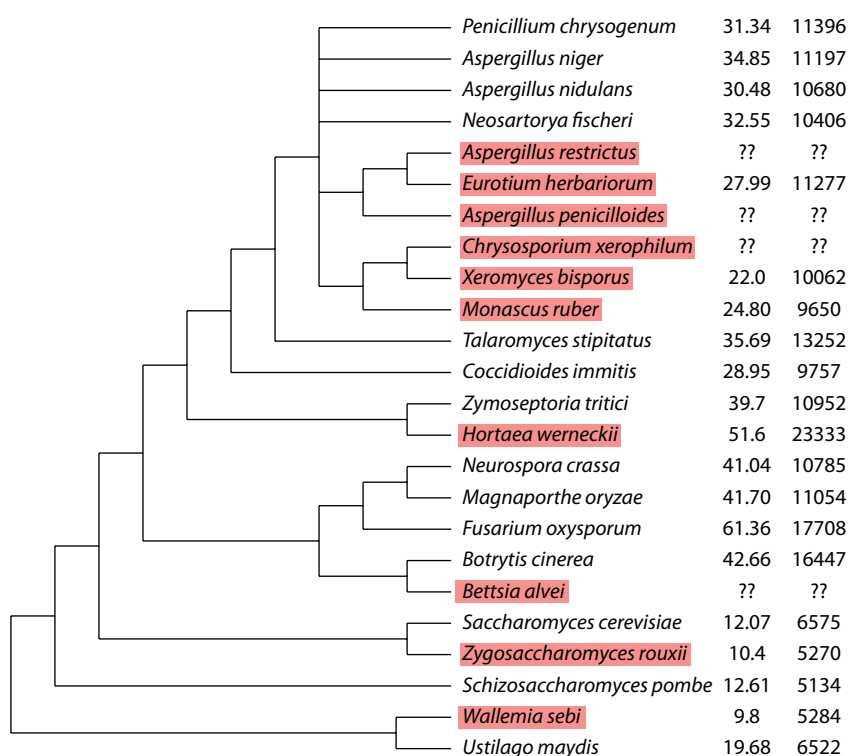

**Fig. 1.** Schematic showing phylogenetic placement of *X. bisporus* among other fungal species, genome size and number of genes noted, where known. Xerophilic species are marked in red.

common to all eukaryotes (248 ultra-conserved core eukaryotic genes), i.e. if the genome is completely assembled, those genes are expected to be present. In our assembly, the CEGMA value was approximately 94% (present as complete genes) and 97% if we include those present as partial genes. This tells us that gene space is almost completely assembled and that the smaller size of the assembly compared with the estimated genome size (22.0/24.8 Mb) can be explained by mostly non-coding regions missing from the assembly (in all likelihood repeats). Thus, we deemed the quality of our assembly to be appropriate for gene finding. The genome sequence data have been submitted to the European Nucleotide Archive (EMBL) under accession number PRJEB6149.

#### *Minimal production of secondary metabolites*

Secondary metabolites can be defined as small molecule chemical differentiation products (Luckner *et al.*, 1977) that are outwards directed and first of all involved in biotic interactions (Meinwald, 2009). Zac and Wildman (2004) emphasized that stress-selected and ruderal-selected fungi produce very few secondary metabolites and exoenzymes, whereas competition-selected fungi need to produce a large number of secondary metabolites and exoenzymes. Indeed a primarily stress and ruderal-selected fungus like *Neurospora crassa* produces few secondary metabolites (Galagan *et al.*, 2003). Like *N. crassa*, *X. bisporus* demonstrated stress-tolerant and ruderal strategies for growth in competition with other xerophilic moulds isolated from high-sugar environments (Leong *et al.*, 2011). Notably absent was any indication of combative strategies by *X. bisporus*, which, unlike some other xerophiles as *Aspergillus restrictus*, *Xerochrysum dermatitidis* and *Xerochrysum xerophilum* (formerly *Chrysosporium inops* and *Chrysosporium xerophilum* respectively; Pitt *et al.*, 2013), did not display any zone of inhibition around its colonies on agar plates. We hypothesize that water activities below the optimum for *X. bisporus* (< 0.84) represent an ecological niche on wizened fruits and berries where there is very little competition from either other fungi or bacteria, and hence, *X. bisporus* would have little need for secondary metabolite compounds to compete with other organisms.

To further investigate the presence/absence of secondary metabolite production by *X. bisporus*, we grew 17 strains isolated from various substrates on malt yeast 50% glucose agar supplemented with corn steep liquor (MYC50G). A medium with 50% glucose w/w will reduce the water activity and thereby support optimal growth of *X. bisporus* strains (Pitt and Hocking, 2009), while the corn steep liquor was added as an additional nitrogen source.

After incubation for 39 days at optimal temperature 30°C, culture extracts were screened for the presence of secondary metabolites by high-performance liquid chromatography-diode array detector (HPLC-DAD), but none were detected (Fig. S1).

This begs the question whether genes involved in secondary metabolism actually could be found in the genome of *X. bisporus* or if they would have been lost or never acquired in evolution. In fungi, genes coding for secondary metabolites are generally located in clusters (Yu and Keller, 2005), usually consisting of a backbone gene (Khaldi *et al.*, 2010), as well as additional genes involved in the regulation of transcription of the cluster (Fox and Howlett, 2008) and/or genes that code for enzymes that modify the product of the backbone gene (Andersen *et al.*, 2013). The most comprehensive annotation of secondary metabolite gene clusters in *Aspergillus nidulans* (Inglis *et al.*, 2013) reports 66 clusters, 63 of which have a backbone enzyme associated. Using blast comparisons and synteny-based comparisons using lift-overs, only six of these clusters were partially or completely preserved in *X. bisporus*, with five additional backbone enzyme orthologues present, but in isolated positions not in orthologous clusters (Table 2). A striking example of this is the asperthecin cluster – genes neighbouring the cluster show strong synteny between *A. nidulans* and *X. bisporus*, but the cluster itself is completely missing in *X. bisporus* (Fig. 2). The only secondary metabolite gene cluster that is completely preserved (AN0042-AN0044, Table 2) lacks a backbone enzyme, and it is unknown to which extent it actually is involved in secondary metabolite production. Clusters seem to be prone to gene gain and loss, as also observed in comparisons of two closely related genera, *Aspergillus* and *Neosartorya* (Khaldi *et al.*, 2010). Hence, the overall low level of conservation between *Aspergillus* and *Xeromyces* is, perhaps, not unexpected.

Presence of secondary metabolite clusters in the genome of *X. bisporus* was also investigated using SMURF (Khaldi *et al.*, 2010), an online tool that does not depend on knowledge of clusters in related species, but uses functional domains to identify backbone genes and cluster-associated genes. SMURF identified several genes as possible backbone enzymes, all of them also recognized as backbone enzymes in *A. nidulans* (Table 3), but reported no clusters at all. Several of the identified genes have been ascribed essential functions in *A. nidulans*, like sidC that is involved in peroxisome metabolism (Gründlinger *et al.*, 2013), and this could explain why they have been retained in the *X. bisporus* genome.

We can thus conclude that there is no measurable evidence of secondary metabolites produced in *X. bisporus* and that this is also supported by our genomic data. We find very few genes likely to be involved in

**Table 2.** Presence in *X. bisporus* of secondary metabolite clusters and associated backbone genes reported from *A. nidulans* (Inglis *et al.*, 2013).

Cluster	Backbone enzyme	Size of cluster in <i>A. nidulans</i> (nr. of genes)	Size of orthologous cluster in <i>X. bisporus</i>	SMURF result for <i>X. bisporus</i> orthologue
AN0607 (sidC)	AN0607	3	1 <sup>a</sup>	NRPS
AN5318	AN5318	5	1	NRPS-like
AN5610	AN5610	6	2	
AN6236	AN6236	15	9	NRPS
AN6791	AN6791	6	1	PKS
AN7489 (mirC)	AN7489	8	4	PKS-like
AN10297	AN10297	16	1	NRPS-like
AN10396	AN10396	3	2	
AN10430	AN10430	5	1	PKS
AN0653-AN0660	N/A	9	8	
AN0042-AN0044	N/A	3	3	

a. Backbone enzyme at scaffold edge, additional genes could be missing from assembly. NRPS, non-ribosomal peptide synthase; PKS, polyketide synthase.

secondary metabolism in comparison with close relatives in *Aspergillus* and no evidence of functional secondary metabolite clusters. Such changes in secondary metabolite clusters may have a specific ecological significance among xerophilic fungi, as these are in general quite poor producers of secondary metabolites. For example, members of *Aspergillus* section *Restricti* have only been reported to produce asperglaucide and arestrictin A and B and cristatin A (Itabashi *et al.*, 2006). Other closely related xerophilic species, such as *Aspergillus* section *Aspergillus*, formerly called *Eurotium*, produce ascumata (sexual structures) with many more secondary metabolites (Slack *et al.*, 2009), whereas strains with only an *Aspergillus* state (i.e. *A. proliferans*) produce as few

secondary metabolites as *A. restrictus*. The ascumata of *X. bisporus* are colourless, and apparently no secondary metabolites are produced in these ascumata. A common ancestor of these Trichocomaceae fungi probably produced protective secondary metabolites in the ascumata, but why *Xeromyces* lost the ability and *Eurotium* species still have the ability to produce many secondary ascumatal metabolites is still not known. Future comparisons with genome-sequenced *Eurotium* species may help explain this.

It could be argued that sexual reproduction itself, like the production of secondary metabolites, is also an unnecessary expense of energy for a species adapted to a relatively stable environment. This is noted for the strict

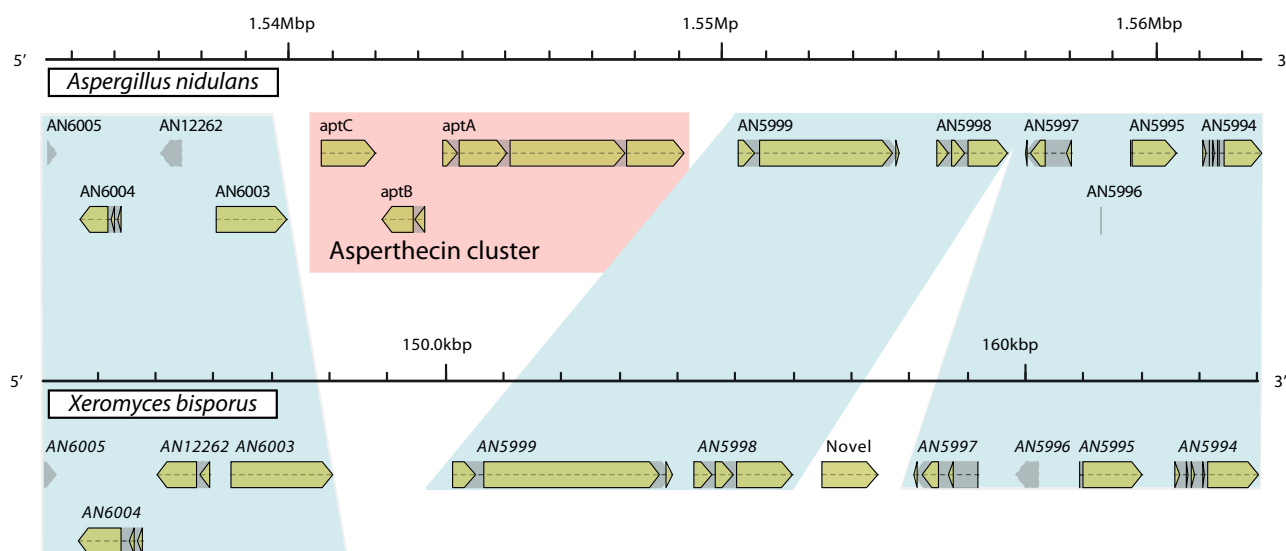

**Fig. 2.** A genome alignment between *A. nidulans* and *X. bisporus* for the region where the asperthecin secondary metabolite gene cluster is present in *A. nidulans*. The neighbouring genes are syntetically preserved in both species (orthologous relationships between genes coloured in blue), but the asperthecin cluster (coloured in red) is not present in *X. bisporus*. The genome assembly for *X. bisporus* was validated using read coverage, and it was concluded that misassembly could not explain the missing cluster.

**Table 3.** Number of secondary metabolite clusters and backbone genes in *Aspergillus* spp. as predicted by SMURF (from Inglis *et al.*, 2013) and *X. bisporus*.

Species	Number of SMURF predicted clusters
<i>Aspergillus fumigatus</i>	33
<i>A. nidulans</i>	49
<i>A. niger</i>	79
<i>A. oryzae</i>	57
<i>X. bisporus</i>	0

halophile isolated from salterns, *Wallemia ichthyophaga*, which does not possess all the genes necessary to complete meiosis (Zajc *et al.*, 2013). In contrast, the related species *Wallemia sebi*, which grows in the presence of both salt and sugar, genetically appears to be capable of sexual recombination, even if this has not yet been observed experimentally (Padamsee *et al.*, 2012). Regarding sexual reproduction, *X. bisporus* is the counter-example to *W. ichthyophaga* – it grows in a similarly narrow niche, in this case, high sugar instead of high salt, and yet it is known predominantly from its sexual stage characterized by two D-shaped ascospores per ascus, hence its name. The asexual *Frasierella* anamorph is rarely seen, although at low water activities, growth on agar plates typically comprises mycelium with no specialized asexual or sexual reproductive structures. Perhaps, with its preference for concentrated sugars, *X. bisporus* is adapted to an extreme environment that, unlike salterns or rock surfaces, has an abundance of nutrients capable of maintaining its meiotic lifestyle.

#### *Xeromyces* does not upregulate stress-response genes at extremely low water activity

In fungi, responses to osmotic stress centre on mitogen-activated protein kinase (MAPK) activation of the key regulator HogA. This signal transduction cascade appears to be well conserved among fungi, ranging from the osmo-sensitive ascomycete *Saccharomyces cerevisiae* (see Saito and Posas, 2012), to basidiomycete osmophiles/halophiles *W. sebi* and *W. ichthyophaga* (Padamsee *et al.*, 2012; Konte and Plemenitaš, 2013). HogA and other sensory, regulatory and downstream elements involved in stress response in Aspergilli were depicted by Miskei and colleagues (2009), and the majority of the osmotic stress response elements are also present in the genome of *X. bisporus* (Fig. 3; Table S1). The ShoA transmembrane sensor and signal transduction pathway are present, and the additional transmembrane sensor in this pathway, Msb2p, a transmembrane mucin that acts in concert with the actin cytoskeleton (Tatebayashi *et al.*, 2007; Tanaka *et al.*, 2014), was significantly differentially upregulated in *X. bisporus* (homologue of AN7041, 7-fold; Table S1). In

the sln1 signal transduction pathway, notable is the apparent absence of the membrane-spanning sensor, TcsB (sln1 in *S. cerevisiae*) in *X. bisporus*, although the other elements of the sln1 signal transduction pathway are present, including the cytoplasmic putative sensor NikA (Hagiwara *et al.*, 2009). In *S. cerevisiae*, the absence of sln1, which negatively represses the HogA MAPK cascade, results in a lethal constitutive activation of the cascade (Maeda *et al.*, 1994); however, the orthologous sensor TcsB does not appear to be critical for the osmotic response in Aspergilli, as a  $\Delta TcsB$  mutant in *A. nidulans* did not differ from the wild-type in conditions of osmotic stress (Furukawa *et al.*, 2002). This appears to also be the case in *X. bisporus*, in which *TcsB* is absent or at least is not present in our genome assembly.

We present data from the first differential transcriptome of a filamentous fungus in steady-state optimal conditions versus low water activity stress (Tables S2 and S3). Very few of the osmotic/oxidative stress signal generation, signal transduction and stress response elements present in *Aspergillus* appeared to be significantly upregulated in *X. bisporus* during growth at extremely low water activity, 0.68 (Fig. 3). The baseline expression levels of the signalling pathways are perhaps to be expected, particularly in steady-state conditions, as stress signals are conveyed via kinase activity and direct protein interactions, rather than high expression of the signalling pathway per se. An exception to this would be the upregulation of one of the *HogA* orthologues in *W. ichthyophaga* at hypo- and hyper-osmotic stress (Konte and Plemenitaš, 2013); however, this was not observed in *X. bisporus*. Figure 3 shows three genes that were significantly upregulated at low water activity: the transmembrane sensor, *Msb2p*, discussed above; catalase, *CatA*, to deal with reactive oxygen species; and, *GfdA*, a NAD<sup>+</sup> dependent glycerol-3-phosphate dehydrogenase involved in metabolism of glycerol, the main compatible solute in *X. bisporus* (discussed in greater detail below). The three genes have a postulated role in growth during stress, but it is somewhat surprising that so few other osmotic stress genes were significantly differentially transcribed. Miskei and colleagues (2009) identified seven transcriptional activators and eight downstream genes proposed to be involved in the osmotic stress response. Of these, five activators were present in *X. bisporus*, including the key regulator MsnA (*Msn2p*, *Msn4p* in *S. cerevisiae*; Causton *et al.*, 2001). Four of the eight proposed downstream genes were present in *X. bisporus*, of which only *GfdA* was significantly upregulated at low water activity. The baseline expression of the three other genes can be explained by our steady-state growth conditions on high sugar: *GppA*, glycerol 3-phosphate phosphatase is not rate limiting in glycerol synthesis (Pählman *et al.*, 2001); *Pmp3* is a cation transporter (Navarre and Goffeau, 2000); and the

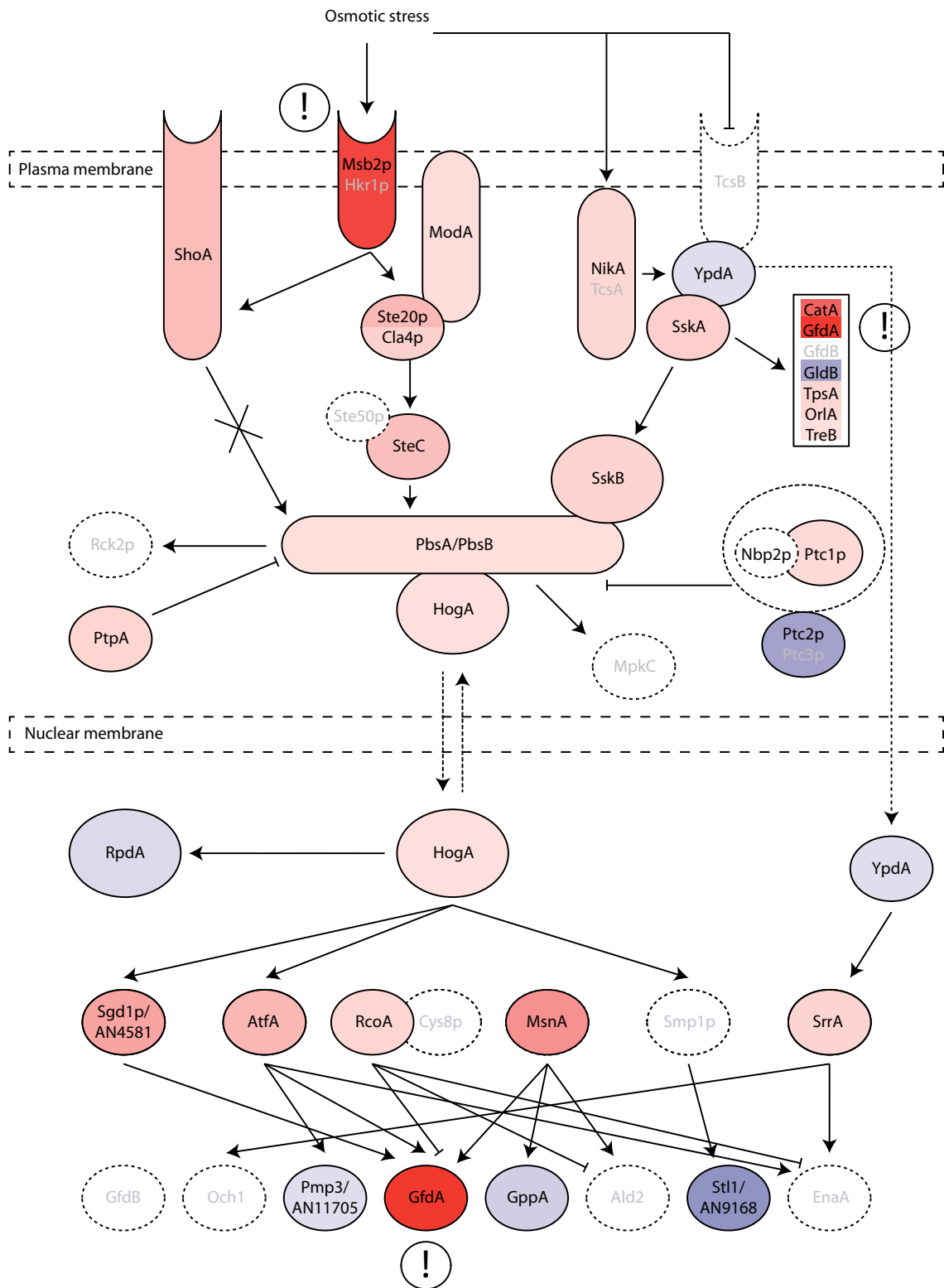

**Fig. 3.** Osmotic stress sensing, signal transduction and response genes expressed in *X. bisporus* based on genes identified in *Aspergillus* species by Miskei and colleagues (2009). Genes present in *Aspergillus* but absent in *X. bisporus* are denoted by dotted lines. Genes somewhat upregulated or downregulated at 0.68  $a_w$  cf. 0.89 (optimum) are shown in pale pink or blue respectively. Only three genes in this schematic were significantly differentially transcribed [upregulated, marked with (!)], namely *Msb2p*, *CatA* and *GfdA*. In *A. nidulans*, ShoA and PbsA/B do not interact (Furukawa *et al.*, 2005; denoted by x); the status of such an interaction in *X. bisporus* is unknown.

*Stt1* H<sup>+</sup> symport/glycerol transporter is only transiently induced (Ferreira *et al.*, 2005). The most highly up-regulated gene, an orthologue of AN5540, can also be attributed to our specific growth conditions with glucose : fructose in the low water activity medium, as this is putatively identified as a major facilitator superfamily transporter with similarities to a fructose transporter. It appears that the Na<sup>+</sup> exporting ATPase, *EnaA*, which is critical for growth on salt by *S. cerevisiae* (Benito *et al.*, 2002), is absent in *X. bisporus*, which may explain its poor growth in the presence of salts. In contrast, metal ion transporters such as *Ena* are both differentially expressed and present in multiple copy in the halophiles *H. werneckii* (Gunde-Cimerman and Plemenitaš, 2006; Lenassi *et al.*, 2013) and, to a lesser extent, *W. ichthyophaga* (Zajc *et al.*, 2013).

The common genes that are differentially expressed in response to a variety of stresses, including osmotic stress, have been termed the environmental stress response, and typically, genes associated with carbohydrate and protein metabolism, intracellular signalling, and damage by ROS and to DNA are upregulated under stress, whereas protein synthesis and growth related processes are downregulated (Saito and Posas, 2012). Using the enrichment test in BLAST2GO (Conesa *et al.*, 2005), no gene ontology (GO) terms in the *X. bisporus* transcriptome were found to be enriched at low or optimal water activity compared with all annotated genes. In other words, no specific functions or processes seem to be upregulated at these conditions as judged from computational gene ontology. Manual inspection of the list of upregulated genes at low water stress yielded only two catalases, *CatA* (noted above) and *CatB*, and five genes putatively involved with DNA repair (orthologues of *RSC1*, *YAF9*, *RAD52/radC* and *bimD*; Table S2); whereas a number of superoxide dismutases were present in *X. bisporus*, none were differentially expressed. It is possible that the statistical tests for individual genes do not reveal subtle fluctuations in entire pathways. However, the overall impression given by the differential transcriptome is that of a fungus showing few signs of extreme osmotic stress, apart from decreased growth rate and increased glycerol production.

Two genes that were upregulated sevenfold at low water activity are connected to glycerol metabolism: glycerone kinase (orthologue of *dak1*) and NAD-dependent glycerol-3-phosphate dehydrogenase (*GfdA*; known as *Gpd1* in *S. cerevisiae*, *H. werneckii* and *W. ichthyophaga*). These both have dihydroxyacetone phosphate (DHAP) as a substrate/product. DHAP is the transition molecule from which intermediates of glycolysis can be directed to glycerol production via either dihydroxyacetone (glycerone) or glycerol-3-phosphate, both pathways being present in *Aspergillus* (Salazar *et al.*,

2009), but only the latter pathway in *S. cerevisiae* and halophiles *H. werneckii* and *W. ichthyophaga* (Lenassi *et al.*, 2011; Saito and Posas, 2012; Zajc *et al.*, 2013). As in *Aspergillus*, putative enzymes to produce glycerol via both pathways are present in *X. bisporus*; however, only genes for the first steps, DHAP to either dihydroxyacetone (*GfdA*) or glycerol-3-phosphate (*dak1*), were significantly upregulated. An alternative FAD-dependent glycerol-3-phosphate dehydrogenase (orthologue of *gut2*) was also transcribed but only slightly upregulated at low water activity (Fig. 4). This is in contrast to *S. cerevisiae*, which in response to osmotic shock showed an approximately fourfold increase in expression of both genes leading to the conversion of DHAP via glycerol-3-phosphate to glycerol (Soufi *et al.*, 2009). However, Pählman and colleagues (2001) noted that overexpression of the glycerol-3-phosphatase (*gpp*) in *S. cerevisiae* did not enhance glycerol production, suggesting that this second step from glycerol-3-phosphate to glycerol is not rate limiting. The importance of the first step, DHAP to glycerol-3-phosphate, is also suggested by duplicate copies of *gpd1* in the halophiles *H. werneckii* and *W. ichthyophaga* (Lenassi *et al.*, 2011; Zajc *et al.*, 2013); however, glycerol synthesis genes in *X. bisporus* appear to be present only in single copy.

In *X. bisporus*, two other genes products for glycolysis after the DHAP/glyceraldehyde-3-phosphate stage were also distinctly upregulated (eightfold): these were glyceraldehyde-3-phosphate dehydrogenase (*gpdA*) and phosphoglycerate kinase (*pgkA*). It can thus be postulated that reactions leading to and from DHAP have a role in modulating glycerol flux at low water activity. Glycerol production may also be modulated at a post-transcriptional level via direct interaction of cytosolic signal transduction elements with enzymes (Bouwman *et al.*, 2011). Indeed, glycerol has a key role in osmoregulation as it is the smallest of the sugar alcohols and confers the greatest reduction in water activity on a molar basis compared with the other sugar alcohols accumulated by fungi during osmotic stress (arabitol, erythritol and mannitol; Hallsworth, 1995). *Xeromyces bisporus* accumulates nearly solely glycerol as a compatible solute as its entire growth is shifted towards conditions of low water activity (Hocking and Norton, 1983).

#### *Sparse mycelium of X. bisporus produces copious amounts of glycerol*

*Xeromyces bisporus* followed the general pattern for fungi (Hocking and Norton, 1983; Gunde-Cimerman *et al.*, 2009), and both produced and accumulated greater concentrations of glycerol at low water activity stress (0.69) than at optimal water activity (0.82–0.86) (Fig. 5). The common foodborne mould, *Aspergillus niger*, displayed a



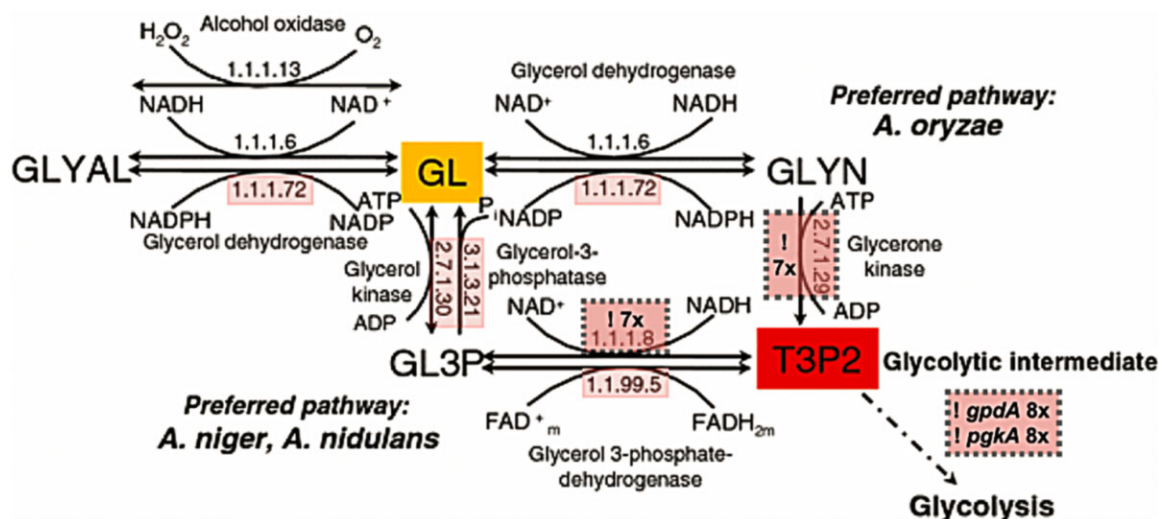
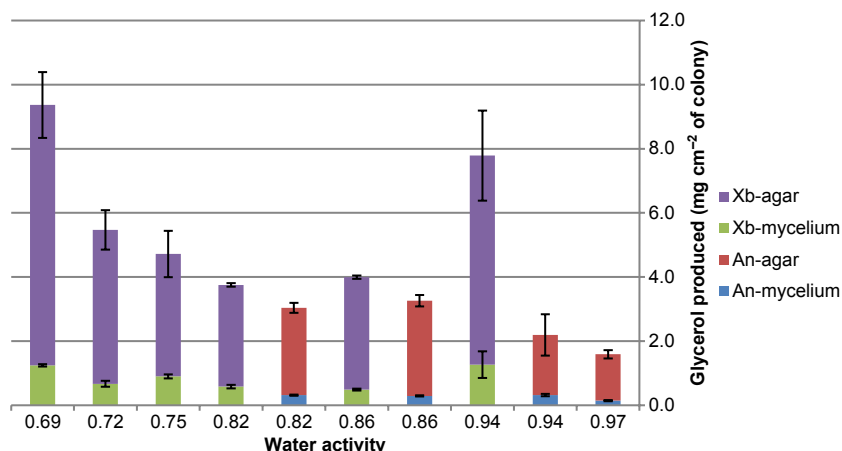

**Fig. 4.** Comparison of glycerol metabolism in *X. bisporus* and *Aspergillus* spp., based on the schematic for *Aspergillus* from Salazar *et al.* (2009; Fig. 3), used with kind permission from Springer Science and Business Media. Pink boxes indicate genes also present in *X. bisporus*. Boxes with dotted lines indicate genes that were significantly upregulated (!) at 0.68  $a_w$  compared with growth at optimal  $\sim 0.89 a_w$ . Caption in original publication: Glycerol utilization pathways in *Aspergillus* species leading to the production of the glycolytic intermediate glycerone phosphate. The abbreviation of metabolites is described as follows: GL, glycerol; GLYAL, D-glyceraldehyde; GLYN, glycerone (dihydroxyacetone); GL3P, sn-glycerol 3-phosphate; T3P2, glycerone phosphate (DHAP).

similar trend (optimum  $> 0.98 a_w$ , low water activity stress at 0.82–0.86). *Aspergillus niger*, can be described as xerotolerant rather than xerophilic because while it can grow at fairly low  $a_w \sim 0.85$  (Pitt and Hocking, 2009), maximal growth occurs at high  $a_w$ . For both species, the majority of glycerol produced leaked into the agar as it is a small molecule and difficult to retain within the cell at high concentrations. Hocking (1986) noted that aging colonies re-absorbed glycerol that had been secreted into the medium; hence, samples in our study were standardized to colony diameter 40 mm (on a 90 mm agar plate), presumed to represent active linear growth, before reabsorption could occur. The xerophilic *X. bisporus* produced approximately twice the amount of glycerol per

colony area than the xerotolerant *A. niger*. Furthermore, *X. bisporus* displayed an additional peak of high glycerol production in conditions of hypo-osmotic stress (0.94  $a_w$ , i.e. above its optimum).

We tested the hypothesis that increased glycerol production was due to increased mycelial density, i.e. that both species produced roughly equivalent amounts of glycerol per cell, but the mycelium of *X. bisporus* was more densely packed than that of *A. niger* for the same colony area. We compared the wet weights of similar size colonies grown in identical conditions (0.89  $a_w$ ). Indeed, the wet weight of *X. bisporus* mycelium was some 16% greater per square centimetre than that of *A. niger* (Fig. 6). The mycelia of both species at 0.89  $a_w$  had a



**Fig. 5.** Glycerol contents of mycelium versus agar from 40 mm diameter colonies of *X. bisporus* FRR 525 and *A. niger* N400 grown on malt yeast extract agar containing glucose and fructose (1:1) to reduce the water activity. Error bars denote standard deviation of four replicates.

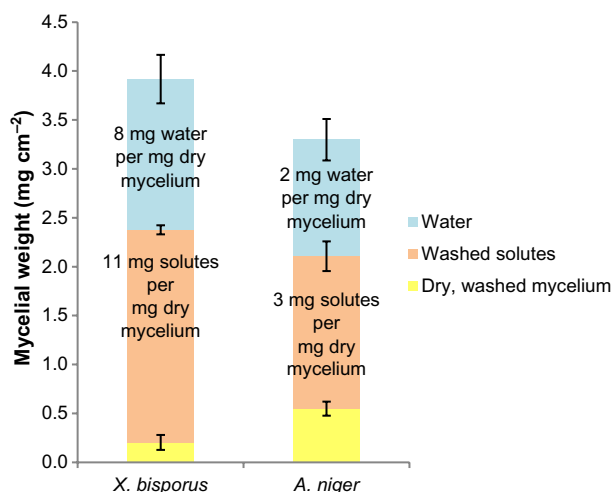

**Fig. 6.** Estimated partitioning of wet mycelial weight into water, washable/rinsable solutes and dry mycelial contents for *X. bisporus* FRR 525 and *A. niger* N400 grown to 40 mm diameter on MY50G agar. Error bars denote standard deviation of duplicate samples.

moist, viscous consistency when harvested from the filter membranes. These mycelia from similar-sized colonies were dried or, alternatively, rinsed with water and then dried, to estimate the proportion that soluble, 'washable'/rinsable components contributed to the wet weight. The dry, 'washed' weight of *X. bisporus*, assumed to comprise dried cellular components, cell walls etc., was approximately one third of that of *A. niger*. This refutes the 'mycelium density hypothesis', suggesting that the mycelium of *X. bisporus* was, instead, less densely packed than that of *A. niger*, but comprised a far greater proportion of water and rinsable (secreted) solutes, probably glycerol, could hint at a possible strategy for its extreme xerophilicity. Perhaps a coat of solutes and water around the mycelium acts as a buffer to non-optimal osmotic environments – increased production of glycerol by *X. bisporus* in hypo-osmotic conditions is in keeping with this idea. Previous examination of *X. bisporus* mycelium by scanning electron microscopy (SEM) indicated a viscous coating (Pettersson *et al.*, 2011; Fig. 7

reproduced with permission). Bekker and colleagues (2012) showed that conidia of *Penicillium rubens* germinating on dry gypsum (water present only as humidity) also produced a viscous exudate or extracellular matrix, which remains as a sheath around conidia even when humidity is reduced. The production of exopolysaccharide is a common strategy by which extremophiles adapt to their environments (Nicolaus *et al.*, 2010); yet it is not known if the 'rinsable' coating around *X. bisporus* mycelium is similar to true exopolysaccharides produced by extremophiles growing in aqueous environments, e.g. *D. salina* (Mishra and Jha, 2009) and *Wallemia* spp. (Kralj Kunčič *et al.*, 2010), or if it is primarily composed of excess leaked glycerol. Indeed, the production of glycerol appears to be an integral part of *X. bisporus* growth – it does not seem to be tightly regulated at the transcriptional level (not all enzymes leading to glycerol production were upregulated at 0.68  $a_w$ ). This suggests either a constitutively high expression of the entire pathway and/or extremely efficient production, possibly modulated post-transcription, e.g. by translational efficiency (Warringer *et al.*, 2010) or allosteric control (Bouwman *et al.*, 2011).

#### Membrane fatty acid saturation is increased at low water activity

Like the accumulation of compatible solutes such as glycerol (Grant, 2004), it is common for microbes to respond to osmotic stress by altering various membrane components, such as fatty acids, to hinder the massive efflux of water and compatible solutes from the cell (reviewed by Gostinčar *et al.*, 2009). *Xeromyces bisporus* and other ascomycete moulds commonly isolated from high sugar substrates displayed a trend to increase fatty acid saturation (i.e. decreased unsaturation index, UI) during growth at increasing sugar concentrations (decreasing water activities) when compared with the optimum (Fig. 8). The five species examined comprised one non-xerophile (*Penicillium roqueforti*, optimum  $a_w \sim 0.99$ ), one xerotolerant species (*A. niger*) and three xerophilic species, *X. bisporus*, *Xc. xerophilum* and *Eurotium*

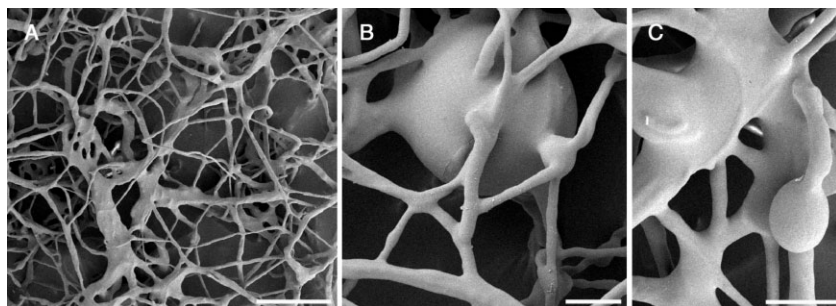

**Fig. 7.** *Xeromyces bisporus* CBS 328.83. CryoSEM investigation after 28 days of growth. Note the presence of an extracellular material around all fungal structures as if they are embedded in a stroma. The pictures show the presence of bundles of (A) hyphae, (B) an ascoma and (C) a stalked conidium. Bars = 20  $\mu\text{m}$  (B, C), 100  $\mu\text{m}$  (A). Reprinted from Pettersson and colleagues (2011) with permission from Elsevier.

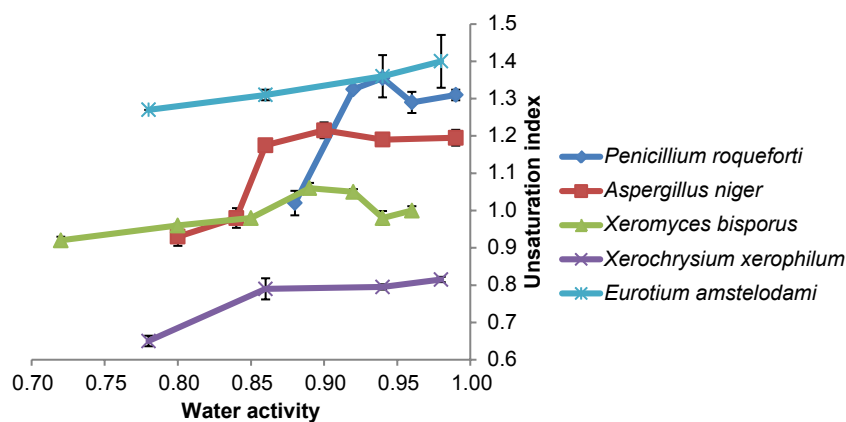

**Fig. 8.** Effect of water activity on the fatty acid UI of five moulds commonly isolated from high-sugar substrates such as foods. *Penicillium roqueforti* is non-xerophilic, *A. niger* is xerotolerant, and *E. amstelodami*, *Xc. xerophilum* and *X. bisporus* are xerophilic. Moulds were grown in malt yeast broth containing glucose as the controlling solute for media  $> 0.8 a_w$ , and with glucose : fructose (1:1) for media of  $0.80 a_w$  and below. Error bars denote the standard deviation of duplicate or more samples.

*amstelodami*, with optimum  $a_w < 0.95$  and good growth at 0.85 (Pitt and Hocking, 2009). The three xerophilic species all showed a fairly gradual decrease in UI over a broad range of water activities, whereas the non-xerophilic and xerotolerant species showed a sharp decline in UI when approaching the limits for their growth. These non-xerophilic/xerotolerant species decreased the amount of double-unsaturated linoleic acid (18:2) and correspondingly increased the mono-unsaturated oleic acid (18:1) (data not shown), likely leading to a more rigid membrane as part of their adaptive response. Similar trends of decreasing linoleic and increasing oleic acids also led to the gradual decrease in UI in the xerophilic species. Phylogenetic patterns in fatty acids profiles were also observed, with the related species *A. niger*, *E. amstelodami* and *P. roqueforti* displaying somewhat higher overall UI than those of the closely related, extreme xerophiles, *X. bisporus* and *Xc. xerophilum*. This raises the question if low UI per se is a mechanism for growth in conditions of extreme osmotic stress – both *X. bisporus* and *Xc. xerophilum* can grow below  $0.7 a_w$  – however, despite their phylogenetic relatedness, the two extreme xerophiles differed in fatty acid profiles. Both contained a lower proportion of linoleic acid (10–30% of total fatty acids) than the *Aspergillus/Penicillium* group (30–65% of total); however, *X. bisporus* was characterized by the highest proportion of oleic acid (50–65% of total) among the five species examined, whereas *Xc. xerophilum* yielded the highest proportions of stearic acid (18:0, 15–20% of total) and palmitic acid (16:0, 15–25% of total), hence its overall low UI.

The increased saturation of membrane fatty acids as an adaptive response to osmotic stress has been described in the non-xerophilic (osmo-sensitive) model yeast, *S. cerevisiae*. In contrast, the halophilic yeasts, *Debaryomyces hansenii* and *H. werneckii*, tend to decrease saturation levels in more saline conditions, thus increasing membrane fluidity (Gunde-Cimerman *et al.*, 2009). It has thus been proposed that the ten-

dency for *S. cerevisiae* to increase, instead of decreasing, fatty acid saturation in response to osmotic stress leads to its osmo-sensitivity, but this is clearly not the case for the mould xerophiles, which appear to share the same strategy as *S. cerevisiae*. In the halotolerant *Aureobasidium pullulans* and halophilic *H. werneckii*, increases in fatty acid desaturation are associated with increased expression of  $\Delta 9$ -desaturase,  $\Delta 12$ -desaturase and elongase (Gostinčar *et al.*, 2009); furthermore, in *H. werneckii*, these are present in duplicate copy in the genome (Gunde-Cimerman *et al.*, 2009). In *X. bisporus*, the following genes encoding key enzymes of fatty acid synthesis and modification were all present as single copies in the genome and were actively transcribed: *fasA* fatty acid synthase,  $\alpha$ -subunit; *fasB* fatty acid synthase,  $\beta$ -subunit; *accA* acetyl-CoA carboxylase; two elongases similar to FEN1 and ELO1 in *S. cerevisiae*; *sdeA*  $\Delta 9$ -stearic acid desaturase similar to OLE1 in *S. cerevisiae*; and *odeA*  $\Delta 12$ -oleic acid desaturase. None of these genes are differentially transcribed in *X. bisporus* at  $0.68 a_w$ ; thus, the activities leading to the observed modifications in fatty acids at low water activity are likely to be under post-transcriptional (allosteric) control, as is typical for such enzymes (Cossins *et al.*, 2002; O'Quin *et al.*, 2010).

Modification of fatty acid saturation is only one of the mechanisms to regulate membrane fluidity in response to osmotic stress. Other mechanisms include altering components such as the lipid head group, or sterol-phospholipid ratio, the latter employed by the halophilic yeasts *D. hansenii* and *H. werneckii* (Gostinčar *et al.*, 2009; Gunde-Cimerman *et al.*, 2009). The transcriptome of *X. bisporus* suggests that such modifications could also be involved in its growth at low water activity, as a number of genes putatively involved in phospholipid, sterol and sphingoglycolipid metabolism are differentially expressed during growth at  $0.68 a_w$  (Table 4). The ergosterol biosynthetic pathway is modulated in such conditions by downregulation of two genes – *ID11*, an

**Table 4.** Notable genes associated with membrane and cell wall structure significantly differentially expressed by *X. bisporus* during growth at 0.68  $a_w$  compared with optimum ~ 0.89  $a_w$ .

Sequence	<i>A. nidulans</i> best blast hit (systematic name)	<i>Aspergillus</i> */ <i>S. cerevisiae</i> best blast hit (standard name)	Differential expression (log2-fold)	Predicted protein function	Function of <i>A. nidulans</i> best blast hit
<b>Phospholipids</b>					
XBISP_00003353	AN7625	INO1	2.1	Inositol-3-phosphate synthase	Putative myo-inositol-1-phosphate synthase with a predicted role in phospholipid metabolism; intracellular, menadione stress-induced protein; <i>palA</i> -dependent expression independent of pH
XBISP_00006068	AN6211	<i>plaA</i> *	2.0	Phospholipase a2	Putative phospholipase with a predicted role in phospholipid metabolism; calcium-dependent phospholipase A2 activity
XBISP_00003810			-4.0	Lysophospholipase carboxylesterase family protein	
XBISP_00001978	AN1855		-3.6	Conserved hypothetical protein	Has domain(s) with predicted phosphoric diester hydrolase activity and role in lipid metabolic process
XBISP_00008196	AN2261	PGS1	-2.7	Cdp-diacylglycerol-glycerol-3-phosphate 3-phosphatidyltransferase	Putative phosphatidylserine synthase with a predicted role in phospholipid metabolism
XBISP_00001248	AN5599	SCT1	-2.5	Glycerol-3-phosphate acyltransferase	Putative glycerol-3-phosphate acyltransferase with a predicted role in phospholipid metabolism
XBISP_00004837	AN1671		-2.4	Pap2 domain protein	Putative diacylglycerol pyrophosphate phosphatase with a predicted role in phospholipid metabolism
XBISP_00002941	AN8216	<i>swoH</i> */YNK1	-1.7	Nucleoside diphosphate kinase	Putative nucleoside diphosphate kinase with a predicted role in phospholipid metabolism; required for normal hyphal growth and conidiation; mutants display increased hyphal cell lysis; transcript upregulated in response to camptothecin
<b>Sterols</b>					
XBISP_00010746	AN6177	<i>floA</i>	3.4		Putative flotillin orthologue, involved in maintenance of sterol-rich plasma membrane domains; required for apical localization of cell-end marker proteins; mutation causes abnormal hyphal morphology
XBISP_00006913	AN9063	SWH1	3.0	Oxysterol binding protein	Orthologue(s) have cytosol localization, SWH1 also involved in sterol transport
XBISP_00009835	AN6506	ERG3	2.9	Sterol delta-desaturase	Putative C-4 sterol methyl oxidase with a predicted role in sterol metabolism
XBISP_00008571	AN0432	MCR1	1.9	Nadh-cytochrome b5	Orthologue(s) have cytochrome-b5 reductase activity, role in cellular response to oxidative stress, ergosterol biosynthetic process and integral to mitochondrial outer membrane, mitochondrial intermembrane space localization
XBISP_00008091	AN7575	ERG26	-4.3	C-3 sterol dehydrogenase c-4 decarboxylase	Putative C-3 sterol dehydrogenase with a predicted role in sterol metabolism
XBISP_00008055	AN1798	YEH2	-3.4	Ab-hydrolase associated	Orthologue(s) have sterol esterase activity, role in cell wall mannoprotein biosynthetic process, sterol metabolic process and integral to membrane, plasma membrane localization; YEH1 involved in sterol homeostasis
XBISP_00010929	AN0579	IDI1	-2.2	Isopentenyl-diphosphate delta-isomerase	Putative isopentenyl-diphosphate delta-isomerase with a predicted role in sterol metabolism
<b>Ceramide</b>					
XBISP_00008648	AN0918	SCS7	3.3	Fatty acid	Putative ceramide hydroxylase with a predicted role in sphingoglycolipid metabolism
XBISP_00002423	AN4992	LRO1	2.7	Phospholipid:diacylglycerol acyltransferase	Orthologue(s) have phospholipid:diacylglycerol acyltransferase activity, role in triglyceride biosynthetic process and endoplasmic reticulum localization; LRO1 involved in ceramide metabolic process
<b>Cell wall structure-glycolipids</b>					
XBISP_00011803	AN4761	<i>pmtB</i> */PMT1	4.8	Protein mannosyltransferase 1	Subfamily 1 protein O-mannosyltransferase; required for normal hyphal growth and conidiophore development, one of seven related proteins involved in O-glycosylation, which is essential for cell wall rigidity

Table 4. cont.

Sequence	<i>A. nidulans</i> best blast hit (systematic name)	<i>Aspergillus*/</i> <i>S. cerevisiae</i> best blast hit (standard name)	Differential expression (log2-fold)	Predicted protein function	Function of <i>A. nidulans</i> best blast hit
XBISP_00004543	AN1811	GPI10	3.0	Gpi mannosyltransferase 3	Orthologue(s) have dolichyl-phosphate-mannose-glycolipid alpha-mannosyltransferase activity, glutathione binding activity, role in GPI anchor biosynthetic process and endoplasmic reticulum localization, The chemical reactions and pathways resulting in the formation of a glycosylphosphatidylinositol (GPI) anchor that attaches some membrane proteins to the lipid bilayer of the cell membrane
XBISP_00011557	AN4761	pmtB*/PMT1	2.9	Protein mannosyltransferase 1	Subfamily 1 protein O-mannosyltransferase; required for normal hyphal growth and conidiophore development
XBISP_00002231	AN4947	DPM1	2.2	Dolichol-phosphate mannosyltransferase	Orthologue(s) have endoplasmic reticulum localization, required for glycosyl phosphatidylinositol membrane anchoring, O mannosylation (also for cell wall rigidity); GPI anchor biosynthetic process
XBISP_00008055	AN1798	YEH2	-3.4	Ab-hydrolase associated	Orthologue(s) have sterol esterase activity, role in cell wall mannoprotein biosynthetic process, sterol metabolic process and integral to membrane, plasma membrane localization
Cell wall structure					
XBISP_00008038	AN1551	btgE*/SCW11	4.2	Cell wall glucanase	Putative beta-glucosidase with predicted role in degradation of glucans; covalently bound cell wall protein
XBISP_00004183	AN2582		4.0		Has domain(s) with predicted role in cell wall macromolecule catabolic process
XBISP_00001977	AN10243		3.6	Inositol-pentakisphosphate 2-kinase	Orthologue(s) have role in fungal-type cell wall organization and cytoplasm, nucleus localization
XBISP_00004060	AN3148	SPO71	2.1		Orthologue(s) have role in ascospore wall assembly and ascospore wall, cytosol, nucleus localization, ascospore wall assembly during meiosis
XBISP_00002853	AN0472	engA*/DSE4	-2.2	Endo-beta-glucanase engl1	Putative 1,3-beta-glucosidase with a role in carbon starvation-induced autolytic cell wall degradation
XBISP_00010798	AN3112	ugmA*	-1.8	Udp-galactopyranose mutase	UDP-galactopyranose mutase, a flavoenzyme that converts UDP-galactopyranose to UDP-galactofuranose, a central enzyme in galactofuranose biosynthesis; involved in cell wall biogenesis

isopentenyl-diphosphate  $\Delta$ -isomerase (step 4 in the pathway from mevalonate to ergosterol) and *ERG26*, C3 sterol dehydrogenase/C4 decarboxylase (steps 12 and 17) – and the upregulation of step 23, *ERG3*  $\Delta$ -desaturase. Furthermore, an orthologue of flotillin is upregulated, *floA*, with the putative function of maintenance of sterol-rich plasma domains. Ceramides may also interact with ergosterol as structural molecules in the membrane, and two genes for ceramide metabolism were upregulated. Differential expression of a number of genes involved in cell wall structure and remodelling points to a role for cell wall rigidity/flexibility during osmotic stress, as noted in the extremely xerophilic yeast, *Zygosaccharomyces rouxii* (Přibylková *et al.*, 2007), and the halophile *W. ichthyophaga* and related species (Kralj Kunčič *et al.*, 2013; Zajc *et al.*, 2014). Four mannosyltransferases, two of which appear to be a duplication of *PMT1*, were upregulated – these have predicted roles in

O-glycosylation, which contributes to cell wall rigidity, as well as anchoring membrane proteins to the lipid bilayer of the cell membrane via glycosylphosphatidylinositol (Orlean, 1990; Bourdineaud *et al.*, 1998; Sutterlin *et al.*, 1998). The upregulation and downregulation of beta-glucanases *SCW11* and *DSE4*, respectively, also suggests fine control of cell wall remodelling.

High concentrations of solutes may additionally exert stress on cellular systems by chaotropic and kosmotropic activity (Hallsworth *et al.*, 2007; Cray *et al.*, 2013b), and the purported changes in membrane and cell wall structure described above may reflect this. In our study, water activities above 0.80 were typically modified by addition of glucose, a relatively neutral solute (chaotropicity +1.19 kJ kg<sup>-1</sup> mol<sup>-1</sup>), whereas 0.80  $a_w$  and below necessitated an equimolar mixture of glucose and fructose (chaotropicity +4.56 kJ kg<sup>-1</sup> mol<sup>-1</sup>), which is presumed to exert some chaotropic stress.

*Xeromyces bisporus* as a model chaophile

In their characterization of known and novel xerophiles from high- and low-solute environments, Williams and Hallsworth (2009) proposed that *X. bisporus* exemplifies a new class of stress-tolerant organisms, chaophiles (Hallsworth *et al.*, 2007), which show a physiological preference for chaotropic conditions, i.e. conditions that disorder rather than stabilize macromolecular structures. Their classification of *X. bisporus* as a chaophile was based on its growth on glycerol-supplemented medium at 0.653  $a_w$  (20.80 kJ kg<sup>-1</sup>; three of four strains tested), glycerol being a highly chaotropic solute at high concentrations. In addition, optimal growth of *X. bisporus* at low  $a_w$  occurred at 30°C, instead of around 22°C for the xerophiles from other genera – high temperature, again, pointing to increased disorder of cellular structures. In contrast, growth of other xerophiles at their lowest  $a_w$  limits was only possible on media containing mixed kosmotropic and chaotropic solutes, i.e. close to neutral chaotropy. Our lowest  $a_w$  media contained glucose : fructose, somewhat chaotropic; and on such media, *X. bisporus* preferentially synthesized and then leaked or secreted glycerol over its entire  $a_w$  range. Chin and colleagues (2010) reported that retarded growth at low temperatures (kosmotropic conditions, generating highly ordered macromolecular structures) by the xerophilic isolate JW07JP13 (species not stated) was better ameliorated by accumulation of chaotropic fructose from the medium than by internal synthesis of glycerol. Preferential accumulation of fructose over glucose from the medium was not observed for *X. bisporus* growing at low water activities on glucose : fructose medium (data not shown). Instead, it synthesized glycerol, in keeping both with glycerol's efficacy as a compatible solute, and with the proposed classification of *X. bisporus* as a chaophile preferring high concentrations of this solute, which is more chaotropic than fructose (+6.34 versus +4.56 kJ kg<sup>-1</sup> mol<sup>-1</sup>). *Xerochrysum xerophilum* (formerly *C. xerophilum*) is phylogenetically closely related to *X. bisporus* (Pettersson *et al.*, 2011; Pitt *et al.*, 2013), and Williams and Hallsworth (2009) reported one strain, FRR 0530, which grew better on glycerol at 0.686  $a_w$  (18.05 kJ kg<sup>-1</sup>) than on other solutes. It is notable that both *Xc. xerophilum* and *X. bisporus* displayed lower UI of membrane fatty acids than *Aspergillus* and *Penicillium*. Perhaps the plasma membrane rigidity conferred by highly saturated fatty acids is partly counteracted by the accumulation of destabilizing, chaotropic glycerol, as a means to maintain membrane permeability even at low  $a_w$ . Both species also have a preference for 30°C when growing at  $a_w$  minima (Leong *et al.*, 2011; Pitt *et al.*, 2013), a temperature that is thought to increase disorder of cellular structures (Williams and Hallsworth, 2009). If so,

then perhaps *Xeromyces* and *Xerochrysum* may represent a new phylogenetic cluster of chaophiles.

**Conclusion**

The high sugar environment which is the niche of *X. bisporus* is unique among low-water habitats in that nutrients are available in abundance. The fruits and berries which are its presumed natural habitat begin first as an open habitat, capable of supporting a diverse microbiota (Cray *et al.*, 2013a). *Xeromyces bisporus* is, in practice, never isolated from this open habitat, and we have demonstrated at the genomic level that it is a true S-strategist, showing the apparent loss of all gene clusters to produce secondary metabolites, key molecules for competition and interaction with other organisms. It is only upon senescence and drying of the fruit, which concentrates the sugars and decreases the water activity that the habitat becomes closed and *X. bisporus* begins to thrive. Indeed, this narrow but comfortable niche has driven few notable changes in its genome and transcriptome – it is a sexually reproducing species, with functional genes for growth in osmotic stress conditions, but only in single copy. Even at very low 0.68  $a_w$ , a clear transcriptomic stress response is notable only by its absence. If microbial weeds are those that come to dominate open habitats, having combative traits and being able to quickly adapt to a variety of stresses (Cray *et al.*, 2013a), then *X. bisporus* must represent a 'non-weed' at the other end of the spectrum – non-combative and apparently unstressed in its extreme low-water environment. It has a generous attitude to potential competitors – they are welcome to share the nutrients only if they can grow with so little water available.

Given that *X. bisporus* is so similar at the genomic level to, say, *Aspergillus* spp., how can it thrive at so much lower  $a_w$ ? Two distinctive physiological traits hint at possible strategies. First, *X. bisporus* appears to constitutively produce excessive amounts of glycerol, increasingly so in conditions of hyper- or hypo-osmotic stress. So much is produced that leaked or secreted solutes and their associated water comprise the bulk of the mycelial wet weight. This strategy could be employed by *X. bisporus* to modulate the micro-environment around its mycelium. Second, a low UI of membrane fatty acids, coupled with high glycerol content, and modifications to phospholipids, sterols and cell wall, could point to a unique 'chaophilic' stress response. *Xeromyces bisporus* and *Xc. xerophilum* are model candidates for defining the molecular mechanisms that support the chaophilic lifestyle.

**Experimental procedures***Genome (growth, DNA extraction, sequencing)*

*Xeromyces* FRR 525 was grown on MY50G (~ 0.89  $a_w$ ; Pitt and Hocking, 2009) on filter membranes (40 mm diameter,

hydrophilic mixed cellulose esters, Metrice<sup>®</sup>, Pall Corporation, MI). Inocula were prepared in 60% glycerol (w/w), and 5 µl was placed in the centre of each membrane, two membranes per 90 mm Petri dish. Plates were incubated at 30°C until the colonies covered the membranes, after which mycelium was harvested from the surface of the membranes for the DNA extraction. Mycelium was re-suspended and washed in TE buffer prior to phenol-chloroform extraction as described by Sambrook and Russell (2001). The DNA pellet was re-suspended in sterile de-ionized water, and aliquots containing 10 µg of pure DNA were sent for whole genome sequencing. In total, three genomic libraries were sequenced: (i) shotgun DNA library, single-end, on Roche 454 FLX at SMI sequencing facility, Stockholm, Sweden at 15× coverage; (ii) Roche 454 FLX mate-pair library with 5 Kb inserts at National Genomics Infrastructure (NGI), SciLifeLab sequencing facility at KTH, Stockholm, Sweden at 5× coverage; and (iii) Illumina paired-end library with 110 + 110 bp on HiSeq 2000 at SNP&SEQ facility of NGI-SciLifeLab Uppsala, Sweden at 100× coverage, following the standard protocols. Data were uploaded to the UPPMAX computation facility at Uppsala University, Sweden.

#### Transcriptome (growth, RNA extraction, sequencing)

*Xeromyces bisporus* FRR 525 was grown at optimal (~ 0.89  $a_w$ ) and low (0.68  $a_w$ ) water activities on filter membranes as described above; a glucose : fructose (1:1) mixture was used in the low  $a_w$  medium to aid dissolution of the solute. Plates were incubated at 30°C until the colonies covered the membranes (14 days for 0.89  $a_w$ ; and 70 days for 0.68  $a_w$ ), after which mycelium was harvested from three independent plates separately for each water activity and immediately homogenized in TRIzol<sup>®</sup> reagent (LifeTechnologies, Sweden). RNA was then extracted following the manufacturer's protocol, dissolved in sterile de-ionized water and pooled from the three independent plates (per water activity). Pooled RNA samples were then sequenced on ABI SOLID 4 at the Uppsala Genome Center, NGI-SciLifeLab, Uppsala, Sweden. Prior to library construction, rRNA was removed by RIBOMINUS module (LifeTechnologies, Sweden), and mRNA libraries were sequenced using the standard stranded SOLID protocol, yielding 40 mln reads per pool. Data were uploaded to the UPPMAX computation facility at Uppsala University, Sweden.

#### Genome assembly

The genome was assembled using NEWBLER 2.5 (Roche Diagnostics Corporation) with the single- and paired-end 454 reads and default settings. The Illumina reads were quality-filtered, and sequencing adapters were removed using Trimmomatic 0.13 (Bolger *et al.*, 2014). The reads were then used to correct for homopolymers and other sequencing errors in the genome assembly using NESONI 0.58 (<http://www.vicbioinformatics.com/software.nesoni.shtml>), with default settings. The genome was unmasked before annotation.

#### Genome annotation and analysis

Three separate lines of evidence were used to infer gene structures independently and then combined to create a ref-

erence annotation. First, fungal protein sequences were extracted from Refseq and aligned to the genome using EXONERATE (Slater and Birney, 2005) to resolve introns. Then the self-training gene finder GENEMARK-ES (Ter-Hovhannisyan *et al.*, 2008) was used to find genes *de novo*. Transcripts were also assembled *de novo* from our SOLID RNA-seq reads using a combination of OASES (Schulz *et al.*, 2012) and VELVET (Zerbino and Birney, 2008), and cleaned using SEQCLEAN (<http://sourceforge.net/projects/seqclean/>). The resulting transcripts were aligned to the genome using PASA (Haas *et al.*, 2003), which also joins overlapping transcripts when necessary. The protein alignment, the *de novo* predictions and the aligned transcripts were then combined into single gene models using EVIDENCE MODELER (Haas *et al.*, 2008). To ensure that novel transcripts also were included, CUFFLINKS 2.01 (Trapnell *et al.*, 2010) was run without a reference annotation to assemble expressed transcripts based on TOPHAT 1.3.2 (Trapnell *et al.*, 2009) alignments of the SOLID RNA-seq reads. Finally, the CUFFLINKS annotation was merged with the EVIDENCE MODELER annotation into a final annotation using Cuffmerge, also in the CUFFLINKS package. The annotation GFF3-file is available for download at doi:10.5879/BILS/ga00001.

Functional annotation was done using the web-service BLAST2GO (Conesa *et al.*, 2005). The built-in InterProScan function was used to add additional GO terms based on inferred functional domains.

#### Differential expression

Cuffdiff in the CUFFLINKS 2.01 package was used to investigate differential expression based on the TOPHAT-mapped SOLID RNA-seq reads and the annotation described above and default values. Cuffdiff calculates a statistic for the significance of the observed change in expression and calls isoforms as significantly differentially expressed after a comparison with the false discovery rate (Trapnell *et al.*, 2013). These significantly differentially expressed isoforms were then investigated manually to ensure that they were not incorrectly annotated. Enrichment of GO terms at low and optimal water activity compared with all annotated genes was investigated using the enrichment test function of BLAST2GO.

#### Screening for secondary metabolite production

Seventeen strains of *X. bisporus* were cultured and analysed for secondary metabolite production. The same strains were used by Pettersson and colleagues (2011) (Table S4). The strains were cultured on MYC50G: malt extract (OXOID, CM0059) 10 g; yeast extract (Biokar A1202HA) 2.5 g; corn steep liquor (Sigma C-4648) 5 g; ZnSO<sub>4</sub>·7H<sub>2</sub>O 0.001 g; CuSO<sub>4</sub>·5H<sub>2</sub>O 0.0005 g; Agar (BBB 10030 SO-BI-Gel, Bie & Berntsen) 10 g; double-distilled water 450 ml. Components were steamed and mixed, and water added to 500 ml. Glucose (D+) (BDH 10117) 500 g was added with stirring. The medium was steamed for a further 30 min before pouring into 90 mm Petri dishes.

The cultures were incubated in the dark for 39 days at 30°C and 37°C. The cultures incubated at 37°C were not analysed because of very poor growth. From 30°C plates, 1.5–2 cm<sup>2</sup> of fungal culture and medium cut by scalpel and additional

mycelium from approximately two colonies (scraped by scalpel) were transferred to a 16 ml vial. One millilitre of extraction solvent [ethyl acetate-dichloromethane-methanol, 3:2:1 v/v/v, containing 1% (v/v) formic acid] was added and left for 60 min in an ultrasonic bath. The extracts were transferred to clean 2 ml vials and evaporated in a rotational vacuum concentrator (RVC; Christ Martin, Osterode, Germany). The residue was dissolved in 400 µl methanol, ultrasonicated for 10 min and filtered through a 0.45-µm PTFE syringe filter (SRI, Eatontown, NJ, USA).

All analyses were performed on an Agilent HP 1100 liquid chromatograph with a DAD system (Waldbronn, Germany). One microlitre of the extract was injected on an Agilent Hypersil BDS-C18 column with 3 µm particles, 125 × 2 mm I.D. column with an Agilent 10 × 2 mm HP Supersphere 100 RP18 guard column. The analysis was done at 40°C and a flow rate of 0.3 ml min<sup>-1</sup> with a water-acetonitrile gradient, starting at acetonitrile-water (15:85, v/v) going to 100% acetonitrile in 20 min, maintaining 100% acetonitrile for 5 min, before returning to the start conditions in 2 min and equilibrating for 5 min. Trifluoroacetic acid, 50 µl l<sup>-1</sup>, was added to the water. The UV spectra were collected by DAD every 0.4 s from 200 to 600 nm with a resolution of 2 nm.

#### Glycerol production

*Xeromyces bisporus* FRR 525 and *A. niger* N400 were inoculated and grown at a range of water activities on filter membranes as described above, on agar media based on MY50G, with equal amounts of glucose and fructose as the controlling solutes. Plates were incubated at 30°C until the colonies covered the membranes (12–89 days for *X. bisporus* at 0.94–0.69 *a<sub>w</sub>*; 2–20 days for *A. niger* at 0.94–0.82 *a<sub>w</sub>*), after which mycelium and agar were harvested for analysis of glycerol content. At harvest, the water activity of the plates was measured by the dew-point technique (AquaLab CX-2, Decagon devices, Pullman, WA, USA).

Mycelia were scraped from the membranes with a spatula, transferred to a plastic tube and weighed. The membrane and agar under the colony plus a 5 mm margin were cut from the Petri dish, transferred to a stomacher bag and weighed. Samples were frozen at –20°C until analysis. Four replicate samples (membranes) were collected at each water activity.

Extraction of glycerol from mycelium was based on the method of Hallsworth and Magan (1997). Mycelia in 2 ml distilled water were sonicated for 4 min (with 1 s on/off pulse) using a Vibra CellVCX 400 (Sonis & Materials, Newton, CT, USA) equipped with a tapered microtip (6.5 mm diameter, amplitude 178 µm). Samples were cooled in an ice-water vessel during sonication. Mycelial extracts were boiled for 6.5 min, centrifuged at 2000 r.p.m. for 10 min to precipitate coarse debris, and filtered (0.2 µm) in preparation for HPLC analysis. As glycerol is highly water soluble and heat stable, recovery was presumed to be 100%.

Agar samples were homogenized with 20 ml distilled water (Stomacher 400, Seward, UK) for 2 min, and the extract collected after vacuum filtration through 1F paper (Munktell, Sweden). A 1 ml aliquot was filtered (0.2 µm) in preparation for HPLC analysis.

Glycerol in mycelial and agar extracts was quantified using an Agilent 1100 HPLC system. Extracts (5 µl) were injected

onto a Rezex ROA-organic acid H<sup>+</sup> column (300 × 7.8 mm, Phenomenex, Denmark) at 60°C with mobile phase 5 mM H<sub>2</sub>SO<sub>4</sub> at 0.6 ml min<sup>-1</sup>. Glycerol was detected with a refractive index detector and quantified by comparison with known standards.

#### Estimation of unwashed and washed mycelial dry weights

Mycelia of *A. niger* and *X. bisporus* grown on 40 mm filter membranes on MY50G were harvested as described above. Mycelia were transferred to pre-weighed filter membranes and the wet weight noted. To estimate the total (unwashed) dry weight, mycelia were directly dried overnight at 70°C. Alternatively, mycelia on filter membranes were first rinsed with 100 ml water using a vacuum filtration system, followed by drying in order to estimate the washed mycelial dry weight. Estimations were performed in duplicate.

#### Analysis of membrane fatty acids

*Xeromyces bisporus* strains FRR 525, FRR 2347 and CBS 328.83 were grown in approximately 50 ml liquid culture at 30°C on media based on MY50G, with differing amounts of glucose (or glucose : fructose mixture at *a<sub>w</sub>* ≤ 0.80) to generate water activities from 0.96 to 0.72. Cultures were inoculated in at least duplicates, and mycelia were harvested after an appropriate amount of growth was observed (49–306 days, depending on *a<sub>w</sub>*) by filtration through Miracloth (Calbiochem, EMD Chemicals, Inc., San Diego, CA, USA) and rinsing several times with distilled water. Excess water was pressed from the mycelial pellet, which was then freeze-dried. Membrane lipids were extracted from freeze-dried material according to Bligh and Dyer (1959) and methylated using boron trifluoride as described by Morrison and Smith (1964). Lipids were quantified by gas chromatography (Kaszycki *et al.*, 2013) and the UI calculated.

Fatty acids (16:0, 18:0, 16:1, 18:1, 18:2 and 18:3) were identified and their relative amounts were determined from peak areas of fatty acid methyl esters (FAMES). The UI was calculated as:

$$UI = (\%16:1 + \%18:1) + (\%18:2 \times 2) + (\%18:3 \times 3) / 100 \quad (1)$$

Membrane fatty acids of a number of other common spoilage moulds of varying xerophilicity were also analysed for comparison with *X. bisporus*, on similar media spanning the water activity range for each species. The strains and conditions examined were as follows: *A. niger* J681 (N400) at 0.99–0.80 *a<sub>w</sub>*; *E. amstelodami* CBS 518.65 at 0.98–0.78 *a<sub>w</sub>*; *Xc. xerophilum* CBS 153.67 at 0.98–0.78 *a<sub>w</sub>*; and *P. roquefortii* J268 (IBT 6754) at 0.99–0.88 *a<sub>w</sub>*.

#### Acknowledgements

This project was supported by the Swedish Research Council Formas, the Carl Tryggers Foundation for Scientific Research and the Faculty of Natural Resources and Agricultural Sciences, Swedish University of Agricultural Sciences. BILS (Bioinformatics Infrastructure for Life Sciences) is kindly acknowledged for bioinformatics support. We thank the



UPPMAX Next-Generation Sequencing Cluster and Storage (UPPNEX) project, funded by the Knut and Alice Wallenberg Foundation and the Swedish National Infrastructure for Computing, for access to computational resources.

## References

- Andersen, M.R., Nielsen, J.B., Klitgaard, A., Petersen, L.M., Zachariassen, M., Hansen, T.J., *et al.* (2013) Accurate prediction of secondary metabolites gene clusters in filamentous fungi. *Proc Natl Acad Sci USA* **110**: E99–E107.
- Bekker, M., Huinink, H.P., Adan, O.C.G., Samson, R.A., Wyatt, T., and Dijksterhuis, J. (2012) Production of an extracellular matrix as an isotropic growth phase of *Penicillium rubens* on gypsum. *Appl Environ Microbiol* **78**: 6930–6937.
- Benito, B., Garcíadeblás, B., and Rodríguez-Navarro, A. (2002) Potassium- or sodium-efflux ATPase, a key enzyme in the evolution of fungi. *Microbiol* **148**: 933–941.
- Bligh, E.G., and Dyer, W.J. (1959) A rapid method of total lipid extraction and purification. *Can J Biochem Physiol* **37**: 911–917.
- Bolger, A.M., Lohse, M., and Usadel, B. (2014) Trimmomatic: a flexible trimmer for Illumina sequence data. *Bioinformatics* **30**: 2114–2120.
- Bourdineaud, J.P., Der Vaart, V., Marcel, J., Donzeau, M., De Sampaio, G., Verrips, C.T., *et al.* (1998) Pmt1 mannosyl transferase is involved in cell wall incorporation of several proteins in *Saccharomyces cerevisiae*. *Mol Microbiol* **27**: 85–98.
- Bouwman, J., Kiewiet, J., Lindenbergh, A., van Eunen, K., Siderius, M., and Bakker, B.M. (2011) Metabolic regulation rather than *de novo* enzyme synthesis dominates the osmo-adaptation of yeast. *Yeast* **28**: 43–53.
- Causton, H.C., Ren, B., Koh, S.S., Harbison, C.T., Kanin, E., Jennings, E.G., *et al.* (2001) Remodeling of yeast genome expression in response to environmental changes. *Mol Biol Cell* **12**: 323–337.
- Chin, J.P., Megaw, J., Magill, C.L., Nowotarski, K., Williams, J.P., Bhaganna, P., *et al.* (2010) Solutes determine the temperature windows for microbial survival and growth. *Proc Natl Acad Sci USA* **107**: 7835–7840.
- Conesa, A., Götz, S., Garcia-Gomes, J.M., Terol, J., Talon, M., and Robles, M. (2005) Blast2GO: a universal tool for annotation, visualization and analysis in functional genomics research. *Bioinformatics* **21**: 3674–3676.
- Cossins, A.R., Murray, P.A., Gracey, A.Y., Logue, J., Polley, S., Caddick, M., *et al.* (2002) The role of desaturases in cold-induced lipid restructuring. *Biochem Soc Trans* **30**: 1082–1086.
- Cray, J.A., Bell, A.N., Bhaganna, P., Mswaka, A.Y., Timson, D.J., and Hallsworth, J.E. (2013a) The biology of habitat dominance; can microbes behave as weeds? *Microb Biotechnol* **6**: 453–492.
- Cray, J.A., Russell, J.T., Timson, D.J., Singhal, R.S., and Hallsworth, J.E. (2013b) A universal measure of chaotropy and kosmotropy. *Environ Microbiol* **15**: 287–296.
- Ferreira, C., van Voorst, F., Martins, A., Neves, L., Oliveira, R., Kielland-Brandt, M.C., *et al.* (2005) A member of the sugar transporter family, Stt1p is the glycerol/H<sup>+</sup> symporter in *Saccharomyces cerevisiae*. *Mol Biol Cell* **16**: 2068–2076.
- Fox, E.M., and Howlett, B.J. (2008) Secondary metabolism: regulation and role in fungal biology. *Curr Opin Microbiol* **11**: 481–487.
- Furukawa, K., Katsuno, Y., Urao, T., Yabe, T., Yamada-Okabe, T., Yamada-Okabe, H., *et al.* (2002) Isolation and functional analysis of a gene, tcsB, encoding a transmembrane hybrid-type histidine kinase from *Aspergillus nidulans*. *Appl Environ Microbiol* **68**: 5304–5310.
- Furukawa, K., Hoshi, Y., Maeda, T., Nakajima, T., and Abe, K. (2005) *Aspergillus nidulans* HOG pathway is activated only by two-component signalling pathway in response to osmotic stress. *Mol Microbiol* **56**: 1246–1261.
- Galagan, J.E., Calvo, S.E., Borkovich, K.A., Selver, E.V., Read, N.D., Jaffe, D. *et al.* (2003) The genome sequence of the filamentous fungus *Neurospora crassa*. *Nature* **422**: 859–868.
- Gostinčar, C., Turk, M., and Gunde-Cimerman, N. (2009) Environmental impacts on fatty acid composition of fungal membranes. In *Fungi from Different Environments*. Misra, J.K., and Deshmukh, S.K. (eds). Enfield, NH, USA: Science Publishers, pp. 278–325.
- Gostinčar, C., Grube, M., De Hoog, S., Zalar, P., and Gunde-Cimerman, N. (2010) Extremotolerance in fungi: evolution on the edge. *FEMS Microbiol Ecol* **71**: 2–11.
- Grant, W.D. (2004) Life at low water activity. *Phil Trans R Soc Lond B* **359**: 1249–1267.
- Gründlinger, M., Yasmin, S., Lechner, B.E., Geley, S., Schrettl, M., Hynes, M., and Haas, H. (2013) Fungal siderophore biosynthesis is partially localized in peroxisomes. *Mol Microbiol* **88**: 862–875.
- Gunde-Cimerman, N., and Plemenitaš, A. (2006) Ecology and molecular adaptations of the halophilic black yeast *Hortaea werneckii*. *Rev Environ Sci Biotechnol* **5**: 323–331.
- Gunde-Cimerman, N., Ramos, J., and Plemenitaš, A. (2009) Halotolerant and halophilic fungi. *Mycol Res* **113**: 1231–1241.
- Haas, B.J., Delcher, A.L., Mount, S.M., Wortman, J.R., Smith, R.K., Jr, Hannick, L.I., *et al.* (2003) Improving the *Arabidopsis* genome annotation using maximal transcript alignment assemblies. *Nucleic Acids Res* **31**: 5654–5666.
- Haas, B.J., Salzberg, S.L., Zhu, W., Pertea, M., Allen, J.A., Orvis, J., *et al.* (2008) Automated eukaryotic gene structure annotation using EvidenceModeler and the Program to Assemble Spliced Alignments. *Genome Biol* **9**: R7.
- Hagiwara, D., Mizuno, T., and Abe, K. (2009) Characterization of NikA histidine kinase and two response regulators with special reference to osmotic adaptation and asexual development in *Aspergillus nidulans*. *Biosci Biotechnol Biochem* **73**: 1566–1571.
- Hallsworth, J.E. (1995) Manipulation of intracellular glycerol and erythritol for successful biological control. Bedford, UK: Cranfield University.

- Hallsworth, J.E., and Magan, N. (1997) A rapid HPLC protocol for detection of polyols and trehalose. *J Microbiol Meth* **29**: 7–13.
- Hallsworth, J.E., Yakimov, M.M., Golyshin, P.N., Gillion, J.L.M., D'Auria, G., Alves, F.D.L., et al. (2007) Limits of life in MgCl<sub>2</sub>-containing environments: chaotropicity defines the window. *Environ Microbiol* **9**: 801–813.
- Hocking, A.D. (1986) Effects of water activity and culture age on the glycerol accumulation patterns of five fungi. *J Gen Microbiol* **132**: 269–275.
- Hocking, A.D., and Norton, R.S. (1983) Natural-abundance <sup>13</sup>C nuclear magnetic resonance studies on the internal solutes of xerophilic fungi. *J Gen Microbiol* **129**: 2915–2925.
- Inglis, D.O., Binkley, J., Skrzypek, M.S., Arnaud, M.B., Cerquiera, G.C., Shah, P., et al. (2013) Comprehensive annotation of secondary metabolite biosynthetic genes and gene clusters of *Aspergillus nidulans*, *A. fumigatus*, *A. niger* and *A. oryzae*. *BMC Microbiol* **13**: 91.
- Itabashi, T., Matsuiishi, N., Hosoe, T., Toyazaki, N., Udagawa, S., Imai, T., et al. (2006) Two new dioxopiparazine derivatives, arestrictins A and B, isolated from *Aspergillus restrictus* and *Aspergillus penicillioides*. *Chem Pharm Bull* **54**: 1639–1641.
- Kaszycki, P., Walski, T., Hachicho, N., and Heipieper, H.J. (2013) Biostimulation by methanol enables the methylotrophic yeasts *Hansenula polymorpha* and *Trichosporon* sp. to reveal high formaldehyde biodegradation potential as well as to adapt to this toxic pollutant. *Appl Microbiol Biotechnol* **97**: 5555–5564.
- Khaldi, N., Seifuddin, F.T., Turner, G., Haft, D., Nierman, W.C., Wolfe, K.H., and Federova, N.D. (2010) SMURF: genomic mapping of fungal secondary metabolite clusters. *Fungal Genet Biol* **47**: 736–741.
- Konte, T., and Plemenitaš, A. (2013) The HOG signal transduction pathway in the halophilic fungus *Wallemia ichthyophaga*: identification and characterisation of MAP kinases WiHog1A and WiHog1B. *Extremophiles* **17**: 623–636.
- Kralj Kunčič, M., Kogej, T., Drobne, D., and Gunde-Cimerman, N. (2010) Morphological response of the halophilic fungal genus *Wallemia* to high salinity. *Appl Environ Microbiol* **76**: 329–337.
- Kralj Kunčič, M., Zajc, J., Drobne, D., Pipan Tkalec, Ž., and Gunde-Cimerman, N. (2013) Morphological responses to high sugar concentrations differ from adaptation to high salt concentrations in the xerophilic fungi *Wallemia* spp. *Fungal Biol* **117**: 466–478.
- Lenassi, M., Zajc, J., Gostinčar, C., Gorjan, A., Gunde-Cimerman, N., and Plemenitaš, A. (2011) Adaptation of the glycerol-3-phosphate dehydrogenase Gpd1 to high salinities in the extremely halotolerant *Hortaea werneckii* and halophilic *Wallemia ichthyophaga*. *Fungal Biol* **115**: 959–970.
- Lenassi, M., Gostinčar, C., Jackman, S., Turk, M., Sadowski, I., Nislow, C., et al. (2013) Whole genome duplication and enrichment of metal cation transporters revealed by *de novo* genome sequencing of extremely halotolerant black yeast *Hortaea werneckii*. *PLoS ONE* **8**: e71328.
- Leong, S.L., Pettersson, O.V., Rice, T., Hocking, A.D., and Schnürer, J. (2011) The extreme xerophilic mould *Xeromyces bisporus* – growth and competition at various water activities. *Int J Food Microbiol* **145**: 57–63.
- Luckner, M., Nover, L., and Böhm, H. (1977) *Secondary Metabolism and Cell Differentiation*. Berlin, Germany: Springer.
- Ma, Y., Galinski, E.A., Grant, W.D., Oren, A., and Ventosa, A. (2010) Halophiles 2010: life in saline environments. *Appl Environ Microbiol* **76**: 6971–6981.
- Maeda, T., Wurgler-Murphy, S.M., and Saito, H. (1994) A two-component system that regulates an osmosensing MAP kinase cascade in yeast. *Nature* **369**: 242–245.
- Meinwald, J. (2009) The chemistry of biotic interactions in perspective: small molecules take center stage. *J Org Chem* **74**: 1813–1825.
- Mishra, A., and Jha, B. (2009) Isolation and characterization of extracellular polymeric substances from micro-algae *Dunaliella salina* under salt stress. *Bioresour Technol* **100**: 3382–3386.
- Miskei, M., Karányi, Z., and Pócsi, I. (2009) Annotation of stress-response proteins in the aspergilli. *Fungal Genet Biol* **46**: S105–S120.
- Morrison, W.R., and Smith, L.M. (1964) Preparation of fatty acid methyl esters and dimethylacetals from lipids with boron fluoride-methanol. *J Lipid Res* **5**: 600–608.
- Navarre, C., and Goffeau, A. (2000) Membrane hyperpolarization and salt sensitivity induced by deletion of PMP3, a highly conserved small protein of yeast plasma membrane. *EMBO J* **19**: 2515–2524.
- Nicolaus, B., Kambourova, M., and Oner, E.T. (2010) Exopolysaccharides from extremophiles: from fundamentals to biotechnology. *Environ Technol* **31**: 1145–1158.
- O'Quin, J.B., Bourassa, L., Zhang, D., Shockey, J.M., Gidda, S.K., Fosnot, S., et al. (2010) Temperature-sensitive post-translational regulation of plant omega-3 fatty acid desaturases is mediated by the endoplasmic reticulum-associated degradation pathway. *J Biol Chem* **285**: 21781–21796.
- Orlean, P. (1990) Dolichol phosphate mannose synthase is required in vivo for glycosyl phosphatidylinositol membrane anchoring, O mannosylation, and N glycosylation of protein in *Saccharomyces cerevisiae*. *Mol Cell Biol* **10**: 5796–5805.
- Padamsee, M., Kumar, T.K., Riley, R., Binder, M., Boyd, A., Calvo, A.M., et al. (2012) The genome of the xerotolerant mold *Wallemia sebi* reveals adaptations to osmotic stress and suggests cryptic sexual reproduction. *Fungal Genet Biol* **49**: 217–226.
- Påhlman, A.K., Granath, K., Ansell, R., Hohmann, S., and Adler, L. (2001) The yeast glycerol 3-phosphatases Gpp1p and Gpp2p are required for glycerol biosynthesis and differentially involved in the cellular responses to osmotic, anaerobic, and oxidative stress. *J Biol Chem* **276**: 3555–3563.
- Pettersson, O.V., Leong, S.L., Lantz, H., Rice, T., Dijksterhuis, J., Houbraken, J., et al. (2011) Phylogeny and intraspecific variation of the extreme xerophile, *Xeromyces bisporus*. *Fungal Biol* **115**: 1100–1111.
- Pitt, J.I., and Christian, J.H.B. (1968) Water relations of xerophilic fungi isolated from prunes. *Appl Microbiol* **16**: 853–1858.

- Pitt, J.I., and Hocking, A.D. (2009) *Fungi and Food Spoilage*, 3rd edn. Dordrecht, the Netherlands: Springer.
- Pitt, J.I., Lantz, H., Pettersson, O.V., and Leong, S.L. (2013) *Xerochrysum* gen. nov. and *Bettsia*, genera encompassing xerophilic species of *Chrysosporium*. *IMA Fungus* **4**: 229–241.
- Příbylová, L., Farkaš, V., Slaninová, I., De Montigny, J., and Sychrová, H. (2007) Differences in osmotolerant and cell-wall properties of two *Zygosaccharomyces rouxii* strains. *Folia Microbiol (Praha)* **52**: 241–245.
- Saito, H., and Posas, F. (2012) Response to hyperosmotic stress. *Genetics* **192**: 289–318.
- Salazar, M., Vongsangnak, W., Panagiotou, G., Andersen, M.R., and Nielsen, J. (2009) Uncovering transcriptional regulation of glycerol metabolism in *Aspergilli* through genome-wide gene expression data analysis. *Mol Genet Genomics* **282**: 571–586.
- Sambrook, J., and Russell, D.W. (2001) *Molecular Cloning: A Laboratory Manual*. Cold Spring Harbor, NY, USA: Cold Spring Harbor Laboratory Press.
- Schulz, M.H., Zerbino, D.R., Vingron, M., and Birney, E. (2012) *Oases*: robust *de novo* RNA-seq assembly across the dynamic range of expression levels. *Bioinformatics* **28**: 1086–1092.
- Slack, G.J., Puniani, E., Frisvad, J.C., Samson, R.A., and Miller, J.D. (2009) Secondary metabolites from *Eurotium* species, *Aspergillus calidoustus* and *A. insuetus* common in Canadian homes with a review of their chemistry and biological activities. *Mycol Res* **113**: 480–490.
- Slater, G.S., and Birney, E. (2005) Automated generation of heuristics for biological sequence comparison. *BMC Bioinformatics* **6**: 31.
- Soufi, B., Kelstrup, C.D., Stoehr, G., Fröhlich, F., Walther, T.C., and Olsen, J.V. (2009) Global analysis of the yeast osmotic stress response by quantitative proteomics. *Mol Biosyst* **5**: 1337–1346.
- Sutterlin, C., Escribano, M., Gerold, P., Maeda, Y., Mazon, M., Kinoshita, T., *et al.* (1998) *Saccharomyces cerevisiae* GPI10, the functional homologue of human PIG-B, is required for glycosylphosphatidylinositol-anchor synthesis. *Biochem J* **332**: 153–159.
- Tanaka, K., Tatebayashi, K., Nishimura, A., Yamamoto, K., Yang, H.Y., and Saito, H. (2014) Yeast osmosensors hkr1 and msb2 activate the hog1 MAPK cascade by different mechanisms. *Sci Signal* **7**: ra21. doi:10.1126/scisignal.2004780.
- Tatebayashi, K., Tanaka, K., Yang, H.Y., Yamamoto, K., Matsushita, Y., Tomida, T., *et al.* (2007) Transmembrane mucins Hkr1 and Msb2 are putative osmosensors in the SHO1 branch of yeast HOG pathway. *EMBO J* **26**: 3521–3533.
- Ter-Hovhannisyanyan, V., Lomsadze, A., Chernoff, Y., and Borodovsky, M. (2008) Gene prediction in novel fungal genomes using an ab initio algorithm with unsupervised training. *Genome Res* **18**: 1979–1990.
- Trapnell, C., Pachter, L., and Salzberg, S.L. (2009) TopHat: discovering splice junctions with RNA-Seq. *Bioinformatics* **25**: 1105–1111.
- Trapnell, C., Williams, B.A., Pertea, G., Mortazavi, A., Kwan, G., van Baren, M.J., *et al.* (2010) Transcript assembly and quantification by RNA-seq reveals unannotated transcripts and isoform switching during cell differentiation. *Nat Biotechnol* **28**: 511–515.
- Trapnell, C., Hendrickson, D.G., Sauvageau, M., Goff, L., Rinn, J.L., and Pachter, L. (2013) Differential analysis of gene regulation at transcript resolution with RNA-seq. *Nat Biotechnol* **31**: 46–53.
- Warringer, J., Hult, M., Regot, S., Posas, F., and Sunnerhagen, P. (2010) The HOG pathway dictates the short-term translational response after hyperosmotic shock. *Mol Biol Cell* **21**: 3080–3092.
- Williams, J.P., and Hallsworth, J.E. (2009) Limits of life in hostile environments: no barriers to biosphere function? *Environ Microbiol* **11**: 3292–3308.
- Yu, Y., and Keller, N.P. (2005) Regulation of secondary metabolism in fungi. *Annu Rev Phytopathol* **43**: 437–458.
- Zac, J.C., and Wildman, H.G. (2004) Fungi in stressful environments. In *Biodiversity of Fungi: Inventory and Monitoring Methods*. Müller, G.M., Bills, G.F., and Foster, M.S. (eds). Burlington, MA, USA: Elsevier, pp. 303–331.
- Zajc, J., Liu, Y., Dai, W., Yang, Z., Hu, J., Gostinčar, C., and Gunde-Cimerman, N. (2013) Genome and transcriptome sequencing of the halophilic fungus *Wallemia ichthyophaga*: haloadaptations present and absent. *BMC Genom* **14**: 1–21.
- Zajc, J., Kogej, T., Galinski, E.A., Ramos, J., and Gunde-Cimerman, N. (2014) Osmoadaptation strategy of the most halophilic fungus, *Wallemia ichthyophaga*, growing optimally at salinities above 15% NaCl. *Appl Environ Microbiol* **80**: 247–256.
- Zerbino, D.R., and Birney, E. (2008) Velvet: algorithms for *de novo* short read assembly using de Bruijn graphs. *Genome Res* **18**: 821–829.

## Supporting information

Additional Supporting Information may be found in the online version of this article at the publisher's web-site:

**Fig. S1.** Example chromatogram obtained from culture extract of *X. bisporus* FRR20 grown on malt yeast corn steep agar with 50% glucose at 30°C for 39 days. Trace 1 shows HPLC-DAD1 A at 210 nm, and trace 2 shows HPLC-DAD1 B at 280 nm. The peaks at the beginning and end of the chromatogram are from the substrate.

**Table S1.** Genes involved in sensing, signal transduction and response to osmotic stress in *X. bisporus* based on those previously identified in *Aspergillus* spp. (Miskei *et al.*, 2009).

**Table S2.** Differentially expressed transcripts of *X. bisporus* FRR 525 at low water activity (0.68) compared with optimal (~0.89). Table sorted in descending order on log<sub>2</sub> fold change of expression. \*Names given for best blast hits in *A. nidulans* and *S. cerevisiae*.

**Table S3.** Differentially expressed transcripts of *X. bisporus* FRR 525 at optimal water activity (~0.89) compared with low (0.68). Table sorted in descending order on log<sub>2</sub> fold change of expression. \*Names given for best blast hits in *A. nidulans* and *S. cerevisiae*.

**Table S4.** Strains of *X. bisporus* assayed for secondary metabolite production by HPLC-DAD.