



High Capacity Radio-over-Fiber Links at 75-300 GHz

Cavalcante, Lucas Costa Pereira; Vegas Olmos, Juan José; Tafur Monroy, Idelfonso

Publication date:
2015

[Link back to DTU Orbit](#)

Citation (APA):

Cavalcante, L. C. P., Vegas Olmos, J. J., & Tafur Monroy, I. (2015). *High Capacity Radio-over-Fiber Links at 75-300 GHz*. Poster session presented at DTU Fotonik Seminar 2014, Lyngby, Denmark.

General rights

Copyright and moral rights for the publications made accessible in the public portal are retained by the authors and/or other copyright owners and it is a condition of accessing publications that users recognise and abide by the legal requirements associated with these rights.

- Users may download and print one copy of any publication from the public portal for the purpose of private study or research.
- You may not further distribute the material or use it for any profit-making activity or commercial gain
- You may freely distribute the URL identifying the publication in the public portal

If you believe that this document breaches copyright please contact us providing details, and we will remove access to the work immediately and investigate your claim.

Lucas C. P. Cavalcante, J. J. Vegas Olmos, Idelfonso T. Monroy

Metro Access & Short-Range Communications, Department of Photonics Engineering, Technical University of Denmark
Ørsted Plads, Building 358-Room 109, Lyngby, 2800, Denmark

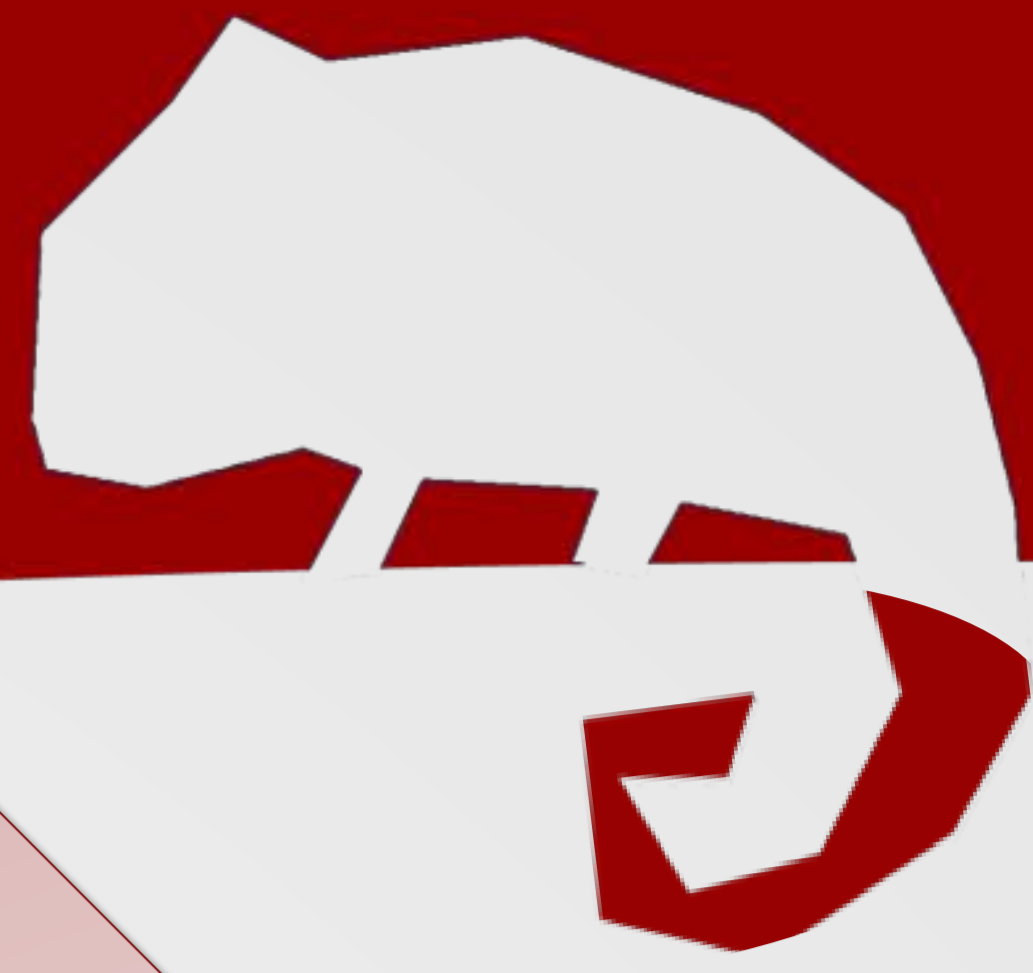

luca@fotonik.dtu.dk

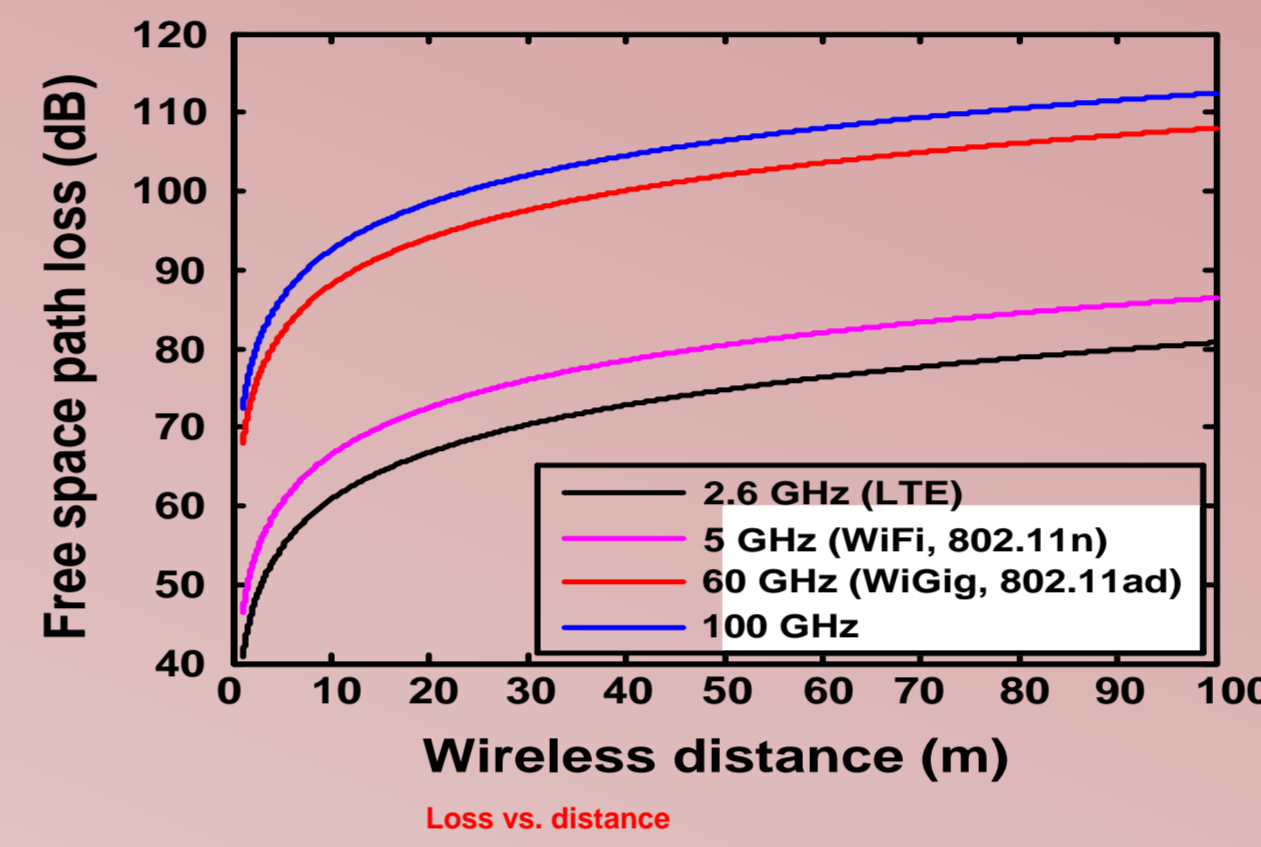
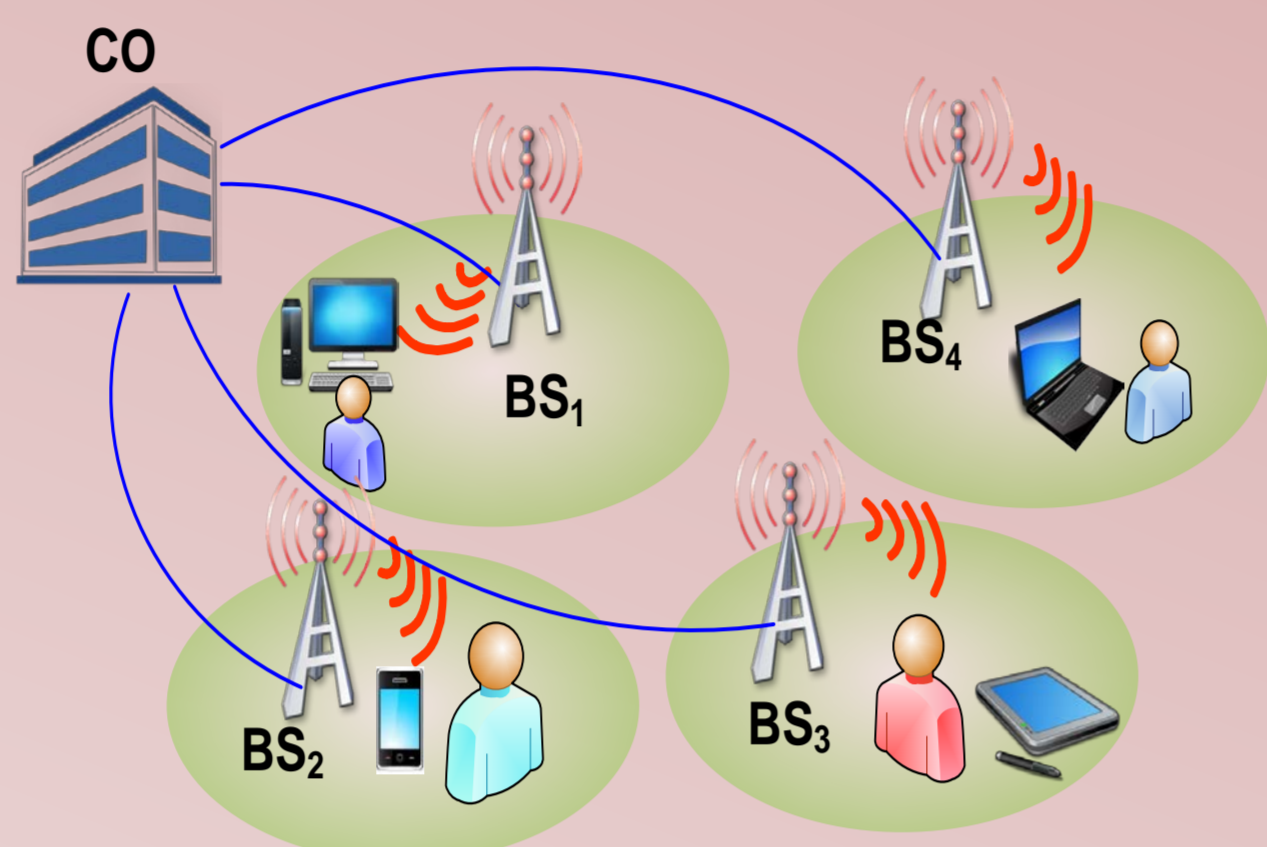
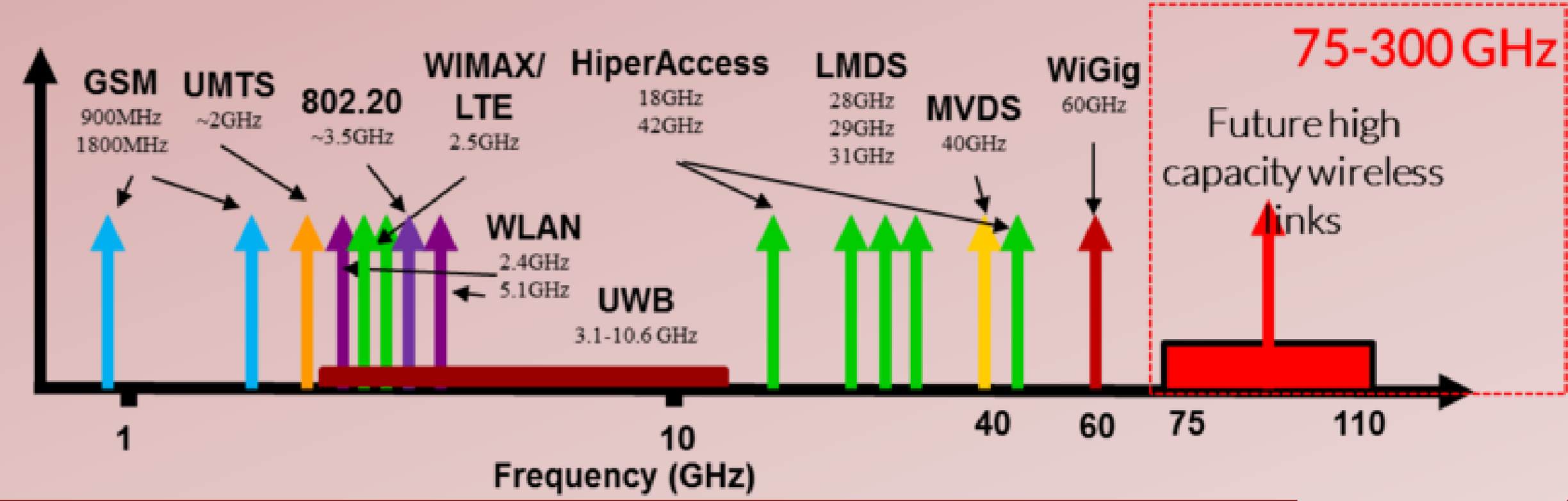
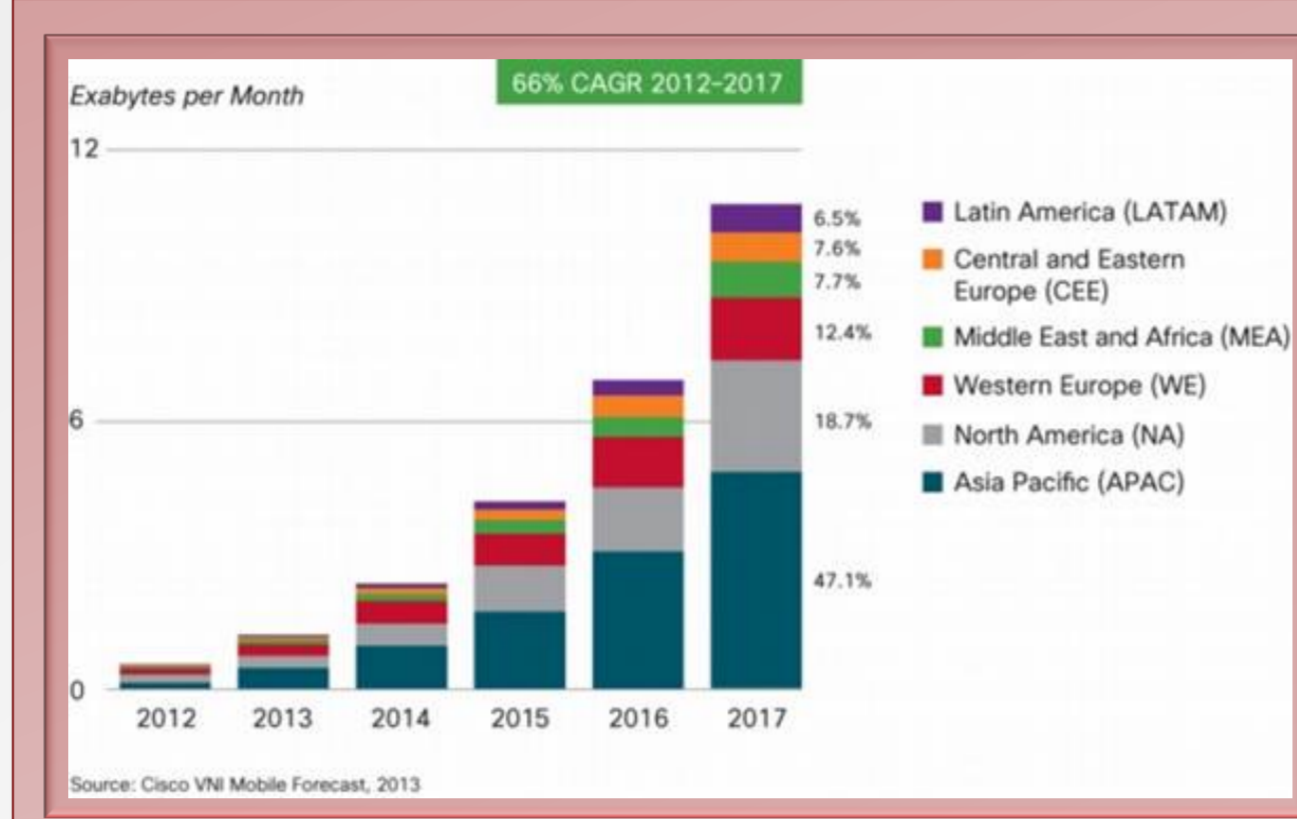

- Radio over Fiber (RoF) represents a hybrid concept
 - Fiber
 - high bandwidth and low losses
 - continuously increasing bandwidth
 - Wireless
 - flexibility and mobility
 - lower capacity
 - operation in higher frequencies

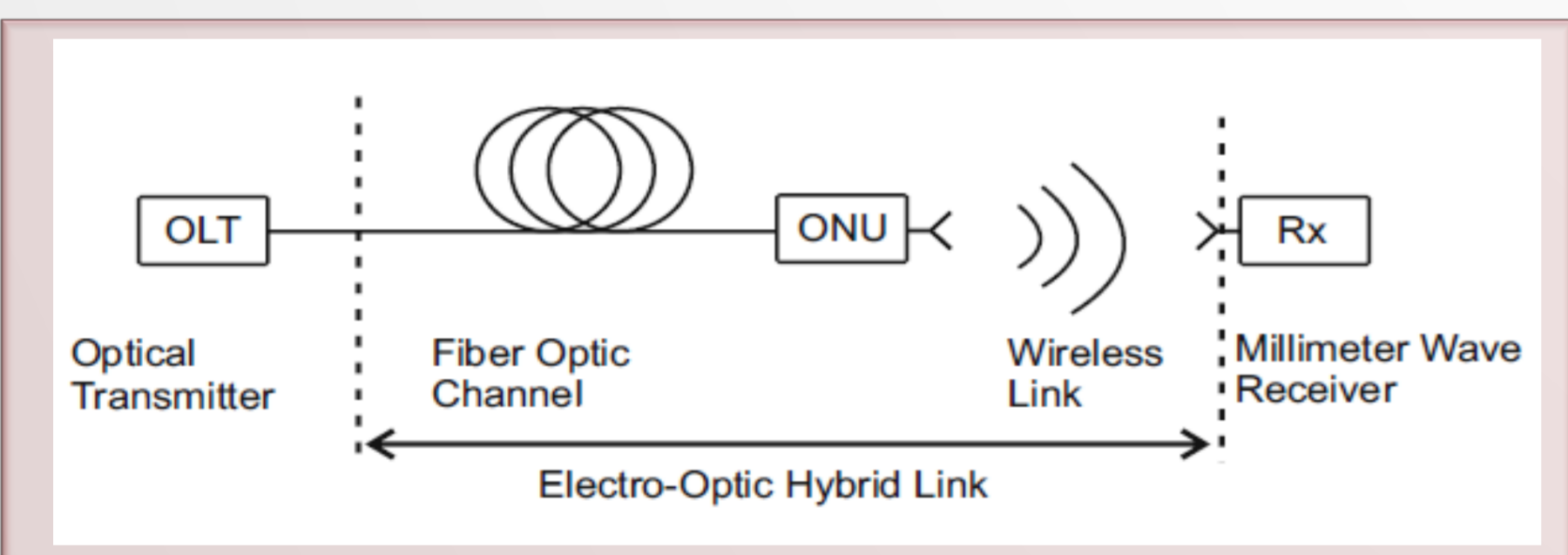

- Advantages of using RoF at W-Band
 - Bandwidth (in terms of bits/s) is not a problem
 - Already developed technology, from optical communications
 - Transport over long distances (or short if one wishes)
 - Generators do not need to be next to the antenna
 - Very good scalability
 - Splitting and amplifying not really a problem in optics (*somehow*)

- Current work
 - Channel model for hybrid composite fiber-wireless
 - Use of advanced modulation formats

How far can we go?

$$C = BW \cdot ld |1 + SNR|$$

$$SNR = P_T + G_T + G_R - L_{FS} - IL - (N_0 + 10 \log_{10} B + NF)$$

$$L_{FS} = 20 \log_{10} \frac{4\pi f d_0}{c} + 10n \log_{10} \frac{d}{d_0}$$

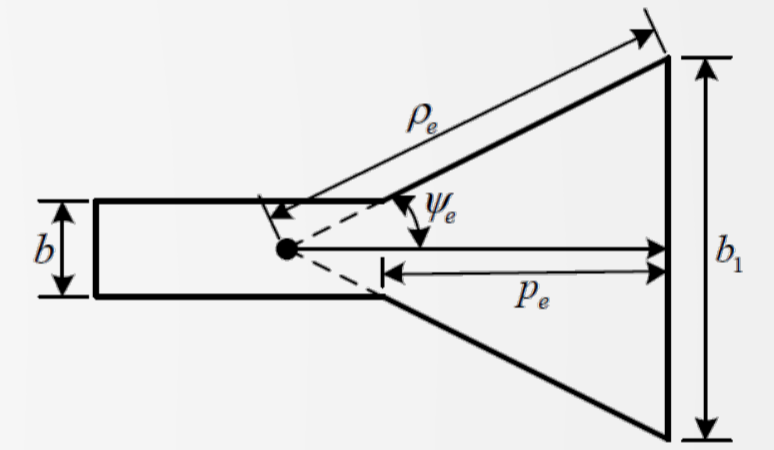

$$G(\phi, \theta) = G_0 \cdot e^{-\left(\frac{\phi, \theta_0}{\sigma_{g, \phi}}\right)^2} \cdot e^{-\left(\frac{\theta, \theta_0}{\sigma_{g, \theta}}\right)^2}$$

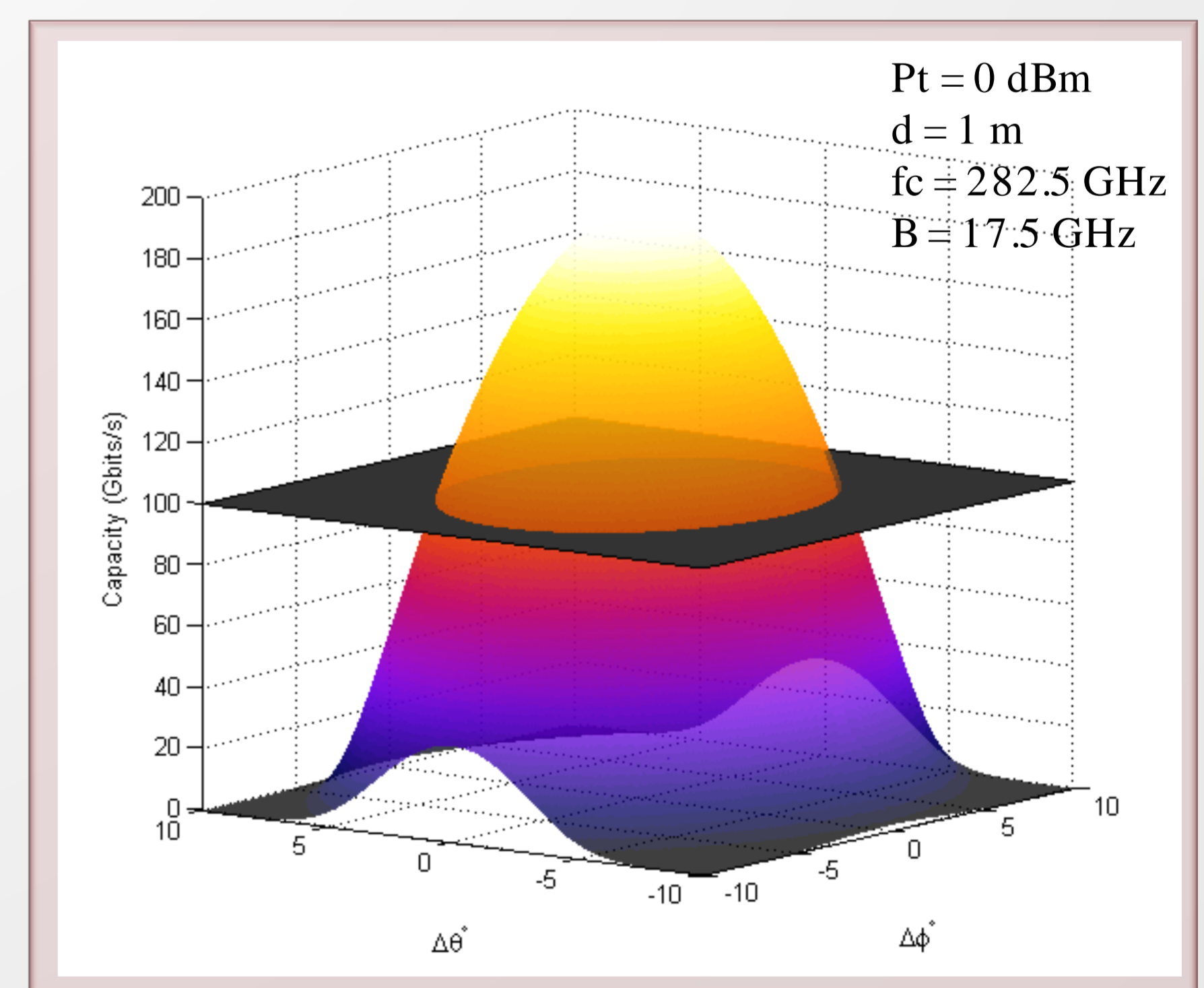
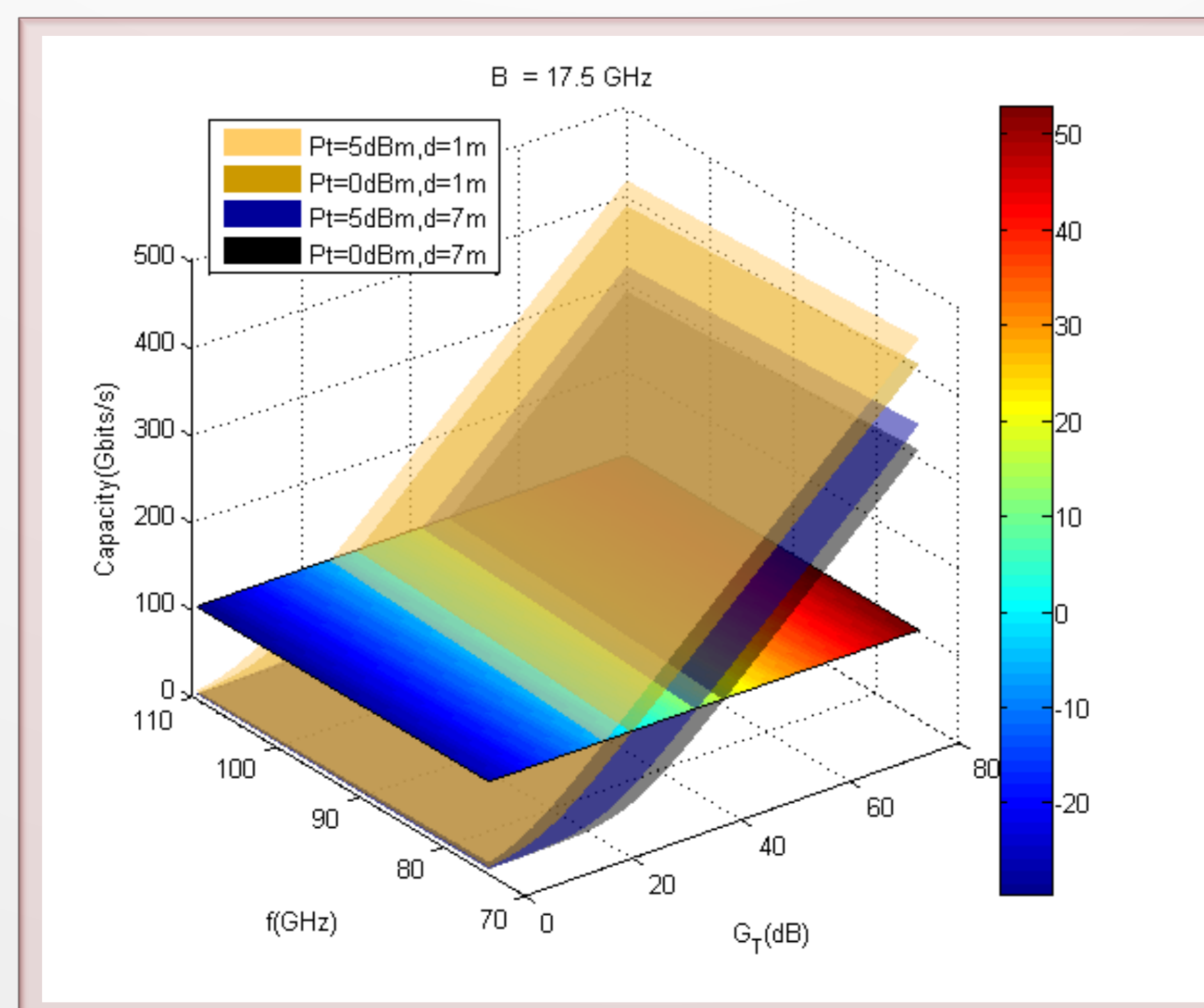
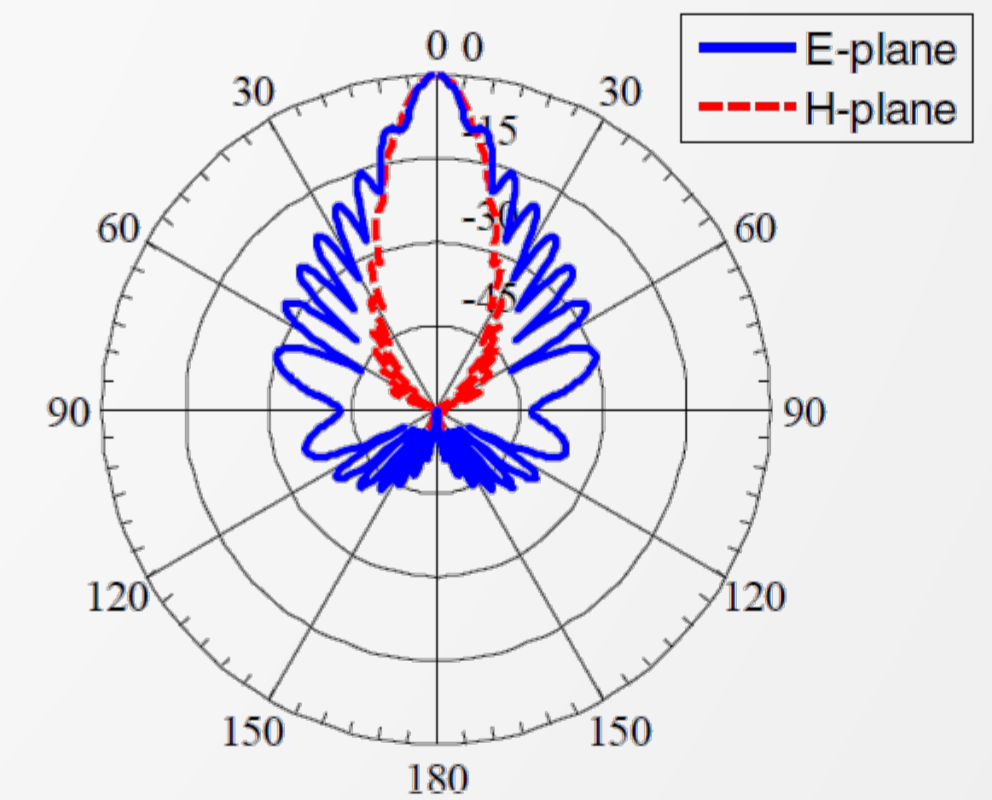

- Photonic technologies enable high capacity wireless links:
 - 100 Gbps wireless transmission
 - Transmission over different types of fibers
 - DSP techniques fairly mature
 - Bidirectional wireless-optical fibre bridge