



## Impact study of PV integration in Bornholm power system

Korompili, Asimena; Zimmermann, Jakob Kjær; Wu, Qiuwei

*Publication date:*  
2014

*Document Version*  
Publisher's PDF, also known as Version of record

[Link back to DTU Orbit](#)

*Citation (APA):*  
Korompili, A., Zimmermann, J. K., & Wu, Q. (2014). *Impact study of PV integration in Bornholm power system*. Technical University of Denmark, Department of Electrical Engineering.

---

### General rights

Copyright and moral rights for the publications made accessible in the public portal are retained by the authors and/or other copyright owners and it is a condition of accessing publications that users recognise and abide by the legal requirements associated with these rights.

- Users may download and print one copy of any publication from the public portal for the purpose of private study or research.
- You may not further distribute the material or use it for any profit-making activity or commercial gain
- You may freely distribute the URL identifying the publication in the public portal

If you believe that this document breaches copyright please contact us providing details, and we will remove access to the work immediately and investigate your claim.

# Impact study of PV integration in Bornholm power system

Asimena Korompili, Jakob K. Zimmermann and Qiuwei Wu

August 2014

## **SCADA data engineering**

2014

By

Asimena Korompili, Jakob K. Zimmermann and Qiuwei Wu

Copyright:      Reproduction of this publication in whole or in part must include the customary bibliographic citation, including author attribution, report title, etc.

Funded by:      Energinet.dk as a part of the framework agreement relating to the use of PowerLabDK's facilities.

Published by:    Department of Electrical Engineering, Elektrovej, Building 325, DK-2800 Kgs. Lyngby, Denmark

Request report [www.elektro.dtu.dk](http://www.elektro.dtu.dk)  
from:

1.	Introduction .....	5
1.1	Objectives of project.....	5
1.1.	Outline of the report.....	6
2.	Impact Study Method.....	6
3.	Technical issues related to the grid integration of PVs .....	8
3.1	Technology of PVs and grid interfacing.....	8
3.2	Limiting factors for the integration of PVs to the power system.....	8
3.2.1	Equipment loading .....	8
3.2.2	Reverse power flow .....	8
3.2.3	Voltage profile .....	9
3.2.4	Interaction with capacitor banks, load tap changing (LTC) transformers and line voltage regulators (VRs).....	9
3.2.5	Reactive power profile.....	9
3.2.6	Active power balance and frequency stability .....	10
3.2.7	Power losses and congestion in the distribution grid .....	10
3.2.8	Power quality .....	11
3.2.9	Short circuit level of the network .....	11
3.2.10	Feeder protection.....	12
3.2.11	Islanded operation of a power network .....	13
3.3	Investigated impact factors .....	13
4.	PV modelling .....	14
4.1	Measurements .....	14
4.2	RTDS model .....	14
5.	Power system and simulation platform .....	15
5.1	The power system of Bornholm .....	15
5.1.1	Oil-based steam plant (Block 5).....	16
5.1.2	CHP plant (Block 6) .....	16
5.1.3	External grid .....	16
5.1.4	Wind turbines .....	17

5.1.5	PV units .....	<b>Error! Bookmark not defined.</b>
5.1.6	Load.....	17
5.2	Simulation platform .....	17
5.2.1	RTDS.....	17
5.2.2	Issues on load flow results of current sources.....	18
5.2.3	Issues on initialisation and stabilisation of dynamic models .....	18
6.	Simulation scenarios .....	19
6.1	Introduction .....	19
6.2	Description of scenarios .....	21
7.	Results.....	21
8.	References .....	25

## 1. Introduction

Over the last decades, the Danish government has taken actions for achieving reduction in primary energy consumption and carbon emissions, while ensuring the energy security. For this purpose, more power plants based on renewable energy sources (RES) are going to be introduced in the power system the next years. Furthermore, the construction costs of large power plants and transmission lines stimulate the increasing number of distributed generation (DG) integrated in the low voltage (LV) and medium voltage (MV) networks. Nowadays, apart from environmental and construction cost issues, rising energy prices and the shortage of fossil fuels constitute also strong motivation for the widespread commissioning of RES-based power units in the distribution grid. However, the introduction of more decentralised power plants based on intermittent energy sources will lead to tremendous changes in the power system. Technical challenges, mainly in power balancing and operational security, are going to be encountered, requiring better system flexibility for maintaining security and reliability of power supply [1-4].

In this context, more photovoltaic systems (PVs) are going to be integrated into the distribution network in the future. As a result, the operation of the system will be altered, since PVs do not behave in the same way as conventional power plants. The fluctuations of their production rise issues on maintaining frequency and voltage stability of the system. Therefore, control methods should be developed and incorporated in PV models. These will enable their participation in the ancillary services of the system for power balancing; hence, introduced controllers could contribute to frequency and voltage regulation. This development is considered to be crucial, taking into account that the controllability of PVs has not been yet totally investigated, leaving a significant margin for exploring such potentials. Consequently there is a great need for research which focuses on the development of revolutionary control structures in PV units. These advanced control technologies are expected to allow the integration of PVs at a higher extent in the future.

### 1.1 Objectives of project

In the framework of such research activities, the main goal of this project is the analysis of the impact of PVs on the operation of the distribution system. Precisely, the real-time response of the power system in the new situation of PVs integration should be investigated. This means that the new operating conditions of the power system should be tested and the issues that may arise should be analysed.

This analysis will then give directions to develop strategies for mitigating the new challenges. The development and implementation of control methods in PV models is the next target of this work. Specifically, the models should present control functions for participating in the ancillary services of the system and therefore contributing to its stability. The performance of the system should be simulated, so that the influence of these control models on the operation of the system can be examined. In this way, the benefits of incorporating such control functionalities can be concluded.

The introduction of controllers in the PV units would reduce the extent of technical challenges arisen by their integration into the system. Therefore, the controllability of PVs could allow higher levels of their penetration. The capability of the power system to incorporate higher amount of PV units, while maintain its stability, is going to be investigated in this research project. Hence, the PV integration limits for this system will be determined.

## 1.1. Outline of the report

The structure of the present report is organised as follows:

- Chapter 2 describes the methodology that is followed for investigating the impact of PVs on the operation of power systems. General guidelines are provided, which apply during the whole project.
- Chapter 3 describes the main technical issues which arise by the grid integration of PVs. A brief introduction to the PV technology is initially provided. The technical challenges encountered due to the PV integration are analysed and the factors that are going to be investigated in the project are chosen.
- Chapter 4 shows the modelling of the PV production in the RTDS simulator.
- In chapter 5, the power system of Bornholm is briefly presented and the models of its components are shortly described. Important aspects regarding the used simulation are also discussed in this chapter.
- Chapter 6 presents the simulation scenarios. General issues are analysed in the introduction of the chapter, providing justification for the definition of the simulated operation conditions. Following this, the different cases are described in details.
- Chapter 7 shows the results.

## 2. Impact Study Method

The analysis of the integration of PVs to the power system and their influence on the operation of the network requires the pursuit of an impact study method. The methodology consists of sequential steps, which are described in the next paragraphs. These general guidelines are followed during the process of the work, as analysed in the following chapters of the report.

- Analysis of challenges in power system operation due to PVs integration

The first phase of the impact study method is the analysis of the technical aspects that are affected by the PV integration into the power system. The introduction of PV units into the distribution system influences the operation of the network and its components. These issues constitute the limiting factors for the integration of PVs in the power system and their higher penetration. Such factors provide a general theoretical background of the PVs impact on the system's operation. Following this, the specific factors that come under the scope of this project should be selected for a detailed analysis.

- Determination of the appropriate PV models

The factors that are going to be examined determine the kind of PV models that are appropriate for the relative simulations. The appropriate control schemes that should be included in the PV dynamic models rely on the aspects that are under investigation. On the other hand, the limitations and main assumptions of the models should also be analysed.

- Selection of the appropriate power system and implementation in the simulation platform

For resulting in more clear conclusions regarding the impact of PVs on the power system operation, an appropriate network should be chosen, in which the influence of PVs is large enough to

be observed. In addition, the system should be suitable for easily achieving high levels of PVs penetration. The components of the system depend on the examined issues. This means that the modelling and implementation of some components whose operation is not investigated could be avoided for simplicity, even though they exist in the real system. Furthermore, the detail level of the models of the implemented components depends also on the kind of simulations. The simulation platform is mainly chosen according to the major objectives of the project. The power system modelling is inextricably connected with the models and functionalities that the simulation platform provides. Therefore, issues of special concern, which are arisen during the modelling of power system in the specific simulation platform, should be discussed.

- Definition of simulation scenarios and quantities to be observed

The system operation conditions which are going to be simulated should be defined according to the impact factors under investigation. Moreover, the simulation scenarios should define such operation modes at which the impact of PV integration is exacerbated. In this way, the limits of the power system to incorporate high PV penetration can be observed. Furthermore, the examined factors determine also the variables that should be monitored and analysed.



## 3. Technical issues related to the grid integration of PVs

### 3.1 Technology of PVs and grid interfacing

Solar cells represent the basic component of a photovoltaic system. The cells are made from semiconductive materials in which the self-contained energy of photons can be transformed into electric energy, when they are exposed to sun light. In this way, the solar cells convert the light received from the sun into electricity [5, 6].

Solar cells are assembled to form a panel or module. A typical PV panel is constructed by 36 or 72 solar cells. The panels are then connected in series or parallel configurations to form a solar array, which constitutes the PV system which is going to produce electrical power. The array can be either fixed or moving to keep tracking the sun in order to produce the maximum power. The rating of solar arrays can be found to be of 0.3kW up to multi-megawatts in large photovoltaic systems. The efficiency of photovoltaic generation is still low, less than 20%. This efficiency decreases to 75-80% of the nominal value during the lifetime of the panels, which can reach more than 25 years [5, 6].

PVs generate DC voltage. Therefore, their connection to the grid is achieved through power electronic converters, which produce AC voltage of the appropriate value and frequency [5, 6].

### 3.2 Limiting factors for the integration of PVs to the power system

The introduction of PVs causes a number of new challenges to distribution network. The impact on the system performance can be manifested to have positive or negative influence, depending on the features of PVs (penetration level and location) and the operation characteristics of the distribution system. Although the integration of PV units can have multifarious benefits, it increases the complexity [5-7]. In light of the increasing amounts of PVs, the distribution system is forced to operate closer to its maximum capacity. Getting more out of the existing assets can pose problems in terms of security of supply and reliability. Operating a system closer to its limits leads to a number of technical constraints and limiting factors which should be considered [8].

#### 3.2.1 Equipment loading

The rated current of the lines at the distribution network should be taken into consideration. Rated current defines the rated active power for the line, i.e. the power transfer strength of the line. The distribution network was not initially designed to accept the connection of production units, due to the limited power transfer strength of lines in medium and low voltage grids. Therefore, the power flows from PVs through distribution lines can cause problems in many cases. The location of PVs can significantly affect the loading of feeder sections. Similarly, it is necessary to verify that the ratings of distribution switchgears and equipment are not exceeded [7-9].

#### 3.2.2 Reverse power flow

Distribution systems operate in a radial configuration, i.e. power flows from the upstream network (transmission system with power sources) towards the load. The feed-in power from PVs changes this one-directional flow. The proliferation of PVs can lead to reverse power flow at sections, feeders and substations. Under high penetration, the total power output of PVs will likely offset the feeder load. The power flow direction will be reversed and the feeder will start

exporting power to neighbour feeders or to the transmission system. The injection of active power leads to the increase of the voltage at the point of interconnection, which can result in problems at the voltage profile. In addition, reverse power flow can negatively affect the over-current protection coordination of the distribution system and the operation of voltage regulators [5-7, 10].

### 3.2.3 Voltage profile

One of the most notorious impacts of PVs is the voltage rise due to too much injection of power. The issue worsens as the penetration level of PVs increases. The effect is particularly evident and problematic when large PV units are connected near the end of long, lightly loaded feeders. In cases of high PV generation and low demand a large amount of power flows along lightly loaded lines, causing a rise in voltage, which may reach the over-voltage levels. This problem is particularly acute in rural areas, where demand tends to be low. On the contrary, under-voltage situations may occur, when the power production of PVs is low and simultaneously the demand is high. The voltage rise problem is exacerbated, considering that the resistive element of the lines at distribution systems is higher than that of the lines at transmission systems. The magnitude of the voltage rise depends on the configuration of each feeder and the location of PV unit and capacitor banks [5, 7, 8, 11-14].

Due to the intermittent nature of PVs, voltage profiles are further deteriorated, since the power output fluctuations lead to voltage variations. Furthermore, there is not usually the possibility of improvement of the voltage profile through reactive power exchange between the distribution network and PVs. Typically, these units interchange reactive power with the grid without coordinated control. In fact, PV inverters are not allowed to absorb reactive power for eliminating over-voltage cases [9, 15, 16].

### 3.2.4 Interaction with capacitor banks, load tap changing (LTC) transformers and line voltage regulators (VRs)

Radial distribution systems regulate the voltage by the aid of LTC transformers at substations, line VRs on distribution feeders and shunt capacitors on feeders or along the line. In the case of VRs equipped with line drop compensation (LDC), voltage regulation is based on one-directional power flow. Therefore, the reverse power flow caused by the integration of PVs in the distribution system leads to problematic operation of these regulators, as mentioned above. Moreover, the voltage rise and the fluctuations at the voltage profiles of the feeders can lead to frequent operation of LTCs, line VRs and voltage-controlled capacitor banks. This causes additional step voltage changes. In addition, more frequent operation of these devices shortens their expected life cycle and increases maintenance requirements. In the case of LTC transformers or line VRs using LDC, the voltage impact may become even more significant because voltage regulation is a function of line current, which is offset by the PV unit. Considering that the PV unit is located downstream the transformer or the voltage regulator, it reduces the load observed by the line drop compensator at the load compensation control side. As a result, the transformer or regulator is deceived, setting lower voltage at the end of the feeder than is required for sufficient service [5, 7, 17].

### 3.2.5 Reactive power profile

Frequent on-off switching of voltage-controlled capacitor banks and frequent operation of LTC transformers and line VRs lead to fluctuations in the reactive power profile. If the penetration level of PVs is large and their location is widespread, this may also affect the transmission sys-

tem. The disconnection of capacitor banks implies that this reactive power has to be supplied by the transmission system. This can have important economic impacts, given that the transmission of reactive power is more expensive than supplying it locally. It also implies increasing losses and loading for transmission lines and distribution substations [7].

### 3.2.6 Active power balance and frequency stability

In any electrical system, power production and power consumption have to be balanced at any time, in order to keep the grid frequency stable. The active power balancing is performed by different mechanisms at different time scales.

At the shortest time scale, the power is balanced by the total spinning inertia of the system. However, the integration of PVs in the distribution network brings challenges to the inertial response to power imbalances. The physics of the power production process at PVs does not include rotating sources, i.e. there is no inertia characteristic. Consequently, the higher penetration of PVs will lead to aggravation of the inertial response to power disturbances, resulting in larger and faster frequency fluctuations.

At the time range from a few seconds to 10 minutes, the primary frequency control mechanism operates, performed by the governor droop control of the synchronous machines. Nevertheless, the increasing replacement of synchronous machines by PV plants results in less units with governor droop characteristics. Hence, less regulating power exists at the system, i.e. fewer machines provide primary frequency control.

Furthermore, more challenges are encountered in frequency stability, bearing in mind the intermittent nature of PV units and the high unpredictability of their power production.

Weak power systems in areas with restricted tie-line interchange or high renewable energy sources (RES) penetration would be more vulnerable to large frequency deviations. Usually, RES power plants do not participate to frequency stability mechanisms. Therefore, increased regulation reserves are required to cover the demand in cases of large PV power variations or low production or forecast errors [9, 18-20].

### 3.2.7 Power losses and congestion in the distribution grid

The amount of power losses in any network varies considerably depending on the design of the grid. The level of losses is closely related to the power flows. With the introduction of PVs, the distribution network is being utilised in a different way with more variable and bi-directional power flows. Therefore, the existence of PVs and the caused altered power flows may have a significant impact on losses [8].

For low to moderate penetration levels, PVs may provide an opportunity to ameliorate power losses. If feeders have high losses, adding a number of small capacity PVs will cause an important positive effect on the losses and have a great benefit to the system. Normally, it is assumed that losses decrease when generation supplies customers in the vicinity. Like PVs can reduce losses when located close to local load centres, they can also contribute to the reduction of the maximal congestion in the power lines. This means that network reinforcements, which have become necessary because of growing load demands, can be deferred by the installation of local PV units [5, 7, 9].

For high PV penetration levels and low coincidence between the production and the local load, line losses tend to increase for several reasons. The loading of distribution lines under high PV penetration may be greater than the normal feeder loading conditions. The feeder capacity is

limited, since overhead lines and cables have thermal characteristics that cannot be exceeded. If feeder capacity boundaries are exceeded, local over-loading of the distribution grid occurs and the network witnesses a high pressure (congestion of the distribution grid). This situation requires grid reinforcements, which is a quite expensive solution to integrate PVs. Another reason of the increase in power losses may be the lack of local reactive power supply via capacitor banks (if they have been switched off due to voltage rise). In addition, the nodal voltage increase resulted by high PV penetration will increase the no-load losses of transformers at the distribution grid [5, 7, 9, 21].

### 3.2.8 Power quality

Power quality is a measure of the proximity of the end user voltage to sinusoidal wave with the rated frequency and the rated voltage magnitude. PVs can have a considerable impact on power quality of the distribution grid [8, 9].

Dynamic variations at the system voltage are known as voltage flicker. Given the variable nature of PVs, fluctuations in solar irradiation cause cyclic voltage fluctuations, denoted as continuous flicker. The cut-in and cut-out of units, especially large capacitors generate transient voltage variations, also known as switching flicker [8, 9].

PVs employ power electronics converters to interface with the system. This can alter the harmonic impedance of the system and lead to harmonic currents. In particular, there is the potential for resonances between capacitors or cables, which can have a detrimental effect on the operation of generators. However, nowadays inverters are redesigned with insulated gate bipolar transistors (IGBTs) that use pulse width modulation (PWM) to generate more 'pure' sinusoidal waves and therefore a cleaner output with fewer harmonics [5, 8, 9].

Normally, the harmonic contribution of PVs is not so important problem regarding their other impacts on the power system. Nevertheless, in some cases problems may arise and the harmonic levels may exceed the standard values. These situations are usually caused by resonance with capacitor banks, or problems with equipment which is sensitive to harmonics. In the worst case, equipment of PVs may need to be disconnected as a consequence of the extra heating resulted by the harmonic currents [5].

### 3.2.9 Short circuit level of the network

The short circuit level is a measure of the strength or robustness of a system and refers to the current that is produced in the case of a fault on the system. The presence of PVs affects the short circuit levels of the network. It creates an increase in the fault currents compared to normal conditions at which no PVs are installed in the network. This could affect the reliability and safety of the distribution system. The influence of PVs to faults depends on their generating size and their distance from the fault location [5, 8].

The fault contribution from a single small PV unit is not large and it will have little effect on the increase of the level of short circuit currents. On the other hand, if many small units or a few large units are installed in the system, they can alter the short circuit levels enough to cause miss coordination between protective devices, like fuses or relays [5].

If PVs are situated between the substation and the fault location, a decrease in fault current from the substation can be observed. This case needs to be investigated for minimum tripping or coordination problems. Moreover, if the PV unit is strong compared to the substation, it may

have a significant impact on the fault current coming from the substation. This may cause fail to trip, sequential tripping, or coordination problems [5].

However, PVs are considered as one of the least contributors to fault currents, since they employ inverters for their connection to the grid. For some inverter types the fault contribution lasts less than one cycle. It should be mentioned that, even though a few cycles are a short time, it may be long enough to impact fuse breaker coordination and breaker duties [5].

### 3.2.10 Feeder protection

The protection systems for distribution networks are traditionally constructed for radial systems, where the power flows from the transmission network down through the lower voltage networks. Protection devices are placed on feeders and laterals of the distribution network, in order to maintain continuous supply to all loads and to protect equipment of the system from power outages. Normally, protection devices have a reach or maximum distance to cover. Furthermore, when designing the protection scheme of a network, coordination between the protection devices must be considered to be able to reach a highly reliable network that will isolate only the faulted sections and will maintain the healthy parts energised. This will increase the reliability of the network. The presence of PVs in a network will have a great impact on the coordination of the protective devices, thus it affects the distribution feeder protection. It also has a great impact on the utility protection devices [5, 8, 9].

The penetration of PVs in an existing distribution network results in an increase in the fault levels; in some cases this increase is of a considerable magnitude in specific parts of the network. This increase causes a lot of problems to the existing protection devices, which can fail in two different ways: by unnecessarily removing a non-faulted part (mal-trip), or by not removing a faulted section (fail-to-trip) [5].

A mal-trip is the case in which one of the protection devices trips instead of the other in a neighbouring radial. This tripping occurs because the protective device detects the fault although this is outside of its protection zone and trips before the correct device trips. In this case the tripping is a result of the current injected by the PV. The protection device will sense the rise in current flowing through it and interpret it as a fault condition and in consequence a trip takes place. Therefore, this type of tripping causes the isolation of a healthy part of the network whilst it is not required. Hence, the reliability of the distribution network is reduced. This situation is presented in Figure 1a [5].

In contrast, fail-to-trip occurs in the case of downstream faults. In this case the current fault is principally formed by the current injected by the PV unit. Consequently, the current through the over-current protection device can be below the setting for which it was designed and the protection remains passive, hence the faulty feeder will not be disconnected. This case is illustrated in Figure 1b [5].

The presence of a PV in the distribution network can also cause a protection deficiency called "reduction of reach". If a large production unit or several small ones are connected to the distribution network, the fault current seen by the feeder protection relay may be reduced, which can lead to improper operation for the over-current relays. Thus, the PV can cause a decrease in the sensitivity of the protection devices, which fail to cover their designed protective distances by decreasing the distance protected. It should be mentioned that this impact increases with the size of the PV unit and its distance from the feeder [5].

The protection devices must be placed along the network at various places, to be able to protect the system components and loads, providing the desired safety. The most common protection device for protecting laterals in distribution networks is a fuse, which is coordinated with other protection equipment of the network like a recloser. This coordination is required in order to be able to save the fuse from blowing out in case of temporary faults. The introduction of PVs will change the power characteristics of the network by contributing to fault currents, which may cause failure of fuse – recloser coordination. The increase in the fault current flowing through the fuse could be sufficient to initiate the blowing of the fuse before the recloser operates [5].

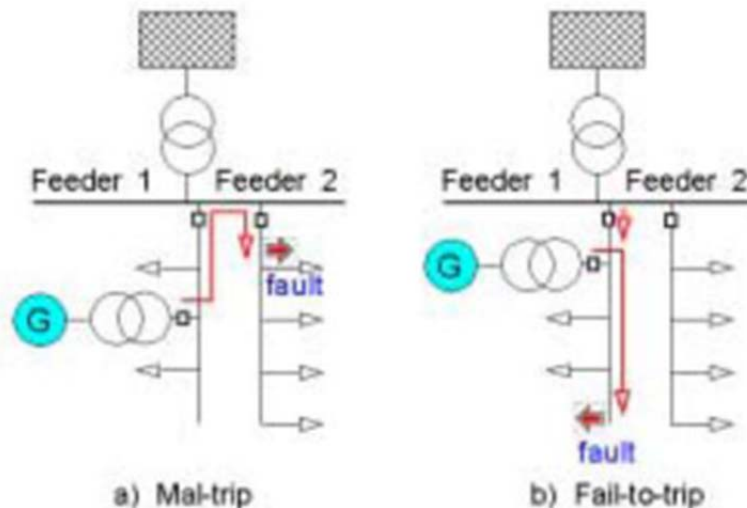

Figure 1 – Mal-trip and fail-to-trip cases [5]

### 3.2.11 Islanded operation of a power network

Islanding of a power network can occur when a PV unit (or group of PV units) continues to energize a portion of the grid that has been separated from the main utility system. This separation could be due to the operation of an upstream breaker, fuse, or automatic sectionalizing switch. Islanded operation can be supported if the unit(s) can maintain the load in the islanded area, keeping suitable voltage and frequency levels in the islanded system. Therefore, in cases of upstream utility source outages, PVs can be used to support 'backup-islands', increasing thus the reliability of the power network [5].

However, the power quality in the island cannot be assured. The islanding operation increases the probability that PVs subject the islanded system to voltage and frequency conditions out of the standard range. In addition, the fault level may be too low, so that the over-current protection will not work in the way it is designed. Therefore, the power quality supplied to customers is worsening. Another disadvantage encountered with islanded operation is the safety problems for the maintenance crews. Personnel working on the line maintenance or repairing a fault may mistakenly consider that the load side of the line is inactive, whereas PVs are indeed feeding power to utilities [5].

### 3.3 Investigated impact factors

The scope of this project is the analysis of the overall operation of the power system in which PVs have been installed. This means that the aspects that are going to be investigated refer to



the operation conditions of the whole system, rather than to the proper functionality of specific components. In this context, the factors that are selected for examination are related to the impact of the PV integration on the power flows in the grid, the (active and reactive) power balance at the system and the voltage profile at the network buses. These issues determine the functions that the dynamic models of PVs should include, as will be described in Chapter 4. As a result, the interaction of PV components with other components of the system (transformers, capacitors and protective devices), as well as the loading conditions of equipment and power losses issues, is not investigated. Consequently, many of these components are not implemented in the power system. Apart from these factors, aspects that refer to power quality and short circuit events are also not analysed and therefore the PV models do not need to include relative functions.

## 4. PV modelling

The PV production is modelled by taking time series data from measurements and using them in the simulation. Instead of adding a separate component to generate the power, the generation is instead subtracted from the load demand at each substation.

### 4.1 Measurements

The measurements are taken from the PV production at DTU, Lyngby building 325 and measured with an Elspec. We would have liked to use measurements from PV production at Bornholm, but there are problems with the measurement equipment at Bornholm so no data is available at the time of this writing.

Using only a single measurement means that the change happens simultaneously at the entire island. If the weather changes from cloudy to sunny it would take some time from the first PV to get sun to the all the PV's receiving sun. This could be simulated with a different time delay to each substation or with measurements from different PV production on the island.

### 4.2 RTDS model

The measured values are saved as p.u. values in a text document. These numbers are imported in to the simulation using the scheduler component in Figure 2.

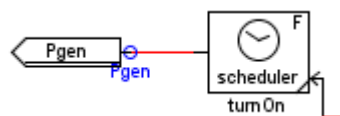

Figure 2 – RTDS scheduler component

The scheduler reads the list of numbers into memory at the start of simulation and it will play back the time series data when started. The output value before the time series data is started is set to the first value in the measurements. After the start of the simulation the system waits 5 seconds before going into islanding mode and then at least 5 seconds more before starting the playback.

At each substation in the grid with connected PV production the load is modified as shown in Figure 3. The playback values are multiplied by the rated value of PV production at that substation and a multiplier. The result is then subtracted from the normal load. The multiplier is controlled by a slider and can be used to simulate increasing PV penetration.

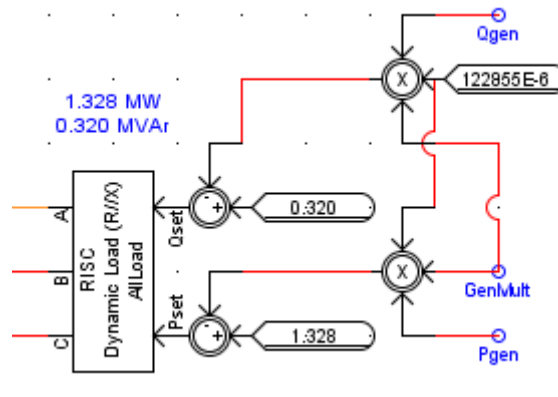

Figure 3 – RTDS dynamic load modified by generation

## 5. Power system and simulation platform

### 5.1 The power system of Bornholm

The issues regarding active power balance and frequency control are usually exacerbated in small and isolated power systems. This occurs due to the lack of inertia and the limited availability of fast reacting reserves at the isolated system. In addition, high levels of PV penetration can easily be achieved in small systems. However, power systems with a relevant penetration of units based on fluctuating and unpredictable energy resources are more vulnerable to large frequency and voltage deviations. Hence, the impact of PV integration on the operation of such systems is larger than in big networks. The power system of the Danish island of Bornholm encompasses all these issues and therefore is an important study case for investigating the impact of PVs integration on its operation [1, 23].

In this chapter a brief introduction of the components of the Bornholm power system is provided. A complete description can be found in [41-43]. The power system of Bornholm consists of a ring-shaped transmission grid of 60kV and a distribution system of 10kV spread all over the island. A more detailed representation of the 10kV substations, with buses of lower voltage, with the feeders and their protective devices, is not provided. Therefore, all the power plants are connected to the 10kV substation buses. The network includes cables and overhead lines, as well as tap-changed transformers. The attributes of these components are provided by CEE. Shunt capacitors and voltage regulating devices are not included. The power system of the island of Bornholm is connected to the Nordic power system through a 60kV submarine cable lying in the Baltic Sea, between southern Sweden and the island. This interconnection is able to cover totally the peak power demand of the island. Thus, the system usually works at a non-isolated mode. However, the system is occasionally forced to operate in isolation. This could occur as a consequence of planned islanding operation or unforeseen outages of the interconnection utilities (cable, transformers) [1, 23]. The diagram of the network, separated in three subsystems, is given in Appendices B.

The power units array includes an oil-based steam plant (Block 5), with a capacity of 25MW, and a CHP steam plant, which is fuelled mainly by coal (Block 6), with a nominal power output of 37.5MW. The total wind power installed in the system is 36 MW, distributed in several wind



farms. The current PV installations are rated to 1.36MW and are spread among the urban areas of the island. There are also 14 diesel generators, with a capacity of 35MW, and a biogas-based power unit of 2MW. On the other hand, the demand lies within the range of 14-56MW [1, 23]. In the following paragraphs a brief description of the models which represent these components is given.

#### 5.1.1 Oil-based steam plant (Block 5)

This power plant is the only unit which is in charge of providing primary frequency control, when the real system is running in the islanded operation. This is achieved through its governor system, which automatically performs a fixed-droop control on the speed deviations. On the contrary, the secondary frequency control is performed manually by the system operator by adjusting the power reference of the governor. The power plant includes also a voltage regulating element [1, 23].

The unit of Block 5 is represented by a synchronous generator with its excitation system and a model for the governor and the steam turbine. The excitation system is developed according to IEEE type ST2A; the representation of the governor and steam turbine system is based on the IEEE type 1 model. Both regulating systems are typically provided by the library of simulation platforms. The evaluation of the parameters of the three elements of Block 5 has been performed by CEE. In addition, in the modelled system, the unit of Block 5 participates in an automatic secondary frequency control (AGC). The AGC system is enabled when the grid operates in isolation, for tuning the power reference of the governor according to frequency variations.

#### 5.1.2 CHP plant (Block 6)

In the actual power system, the CHP plant does not contribute to frequency regulation, since its governor system is usually disabled. The unit provides only voltage regulation through its excitation system [1, 23].

However, with the upcoming trend towards a power system with higher penetration of renewable sources, the CHP unit may be required to participate in the frequency regulation. Therefore, the governor control system is incorporated in the development of this model. Hence, a higher amount of renewable energy sources could possibly be accommodated by the power system of the island. The introduction of this control element implies that the CHP plant should operate in the extraction mode, in which the steam for producing the demanded heat is extracted at the end of the high pressure turbine, letting the rest of the steam flow through the low pressure turbine. In this way, the ratio of heat and electric power is not tight, but instead can move within a certain range. Thus, the unit acquires flexibility, i.e. the electric power can be controlled, while the required amount of heat is covered [1, 23].

The CHP plant is also represented by a synchronous generator accompanied by the models of its excitation system and the governor/turbine system. The models are usually available in the library of simulation platforms; the models of IEEE EXAC1A and IEEE type 1 have been selected for the two systems, respectively. The values of parameters of the generator and its control systems are set by CEE. The CHP plant participates also in the AGC system.

#### 5.1.3 External grid

The external power system of Sweden can inject or absorb the required amount of power for power balance at the power system of Bornholm. Therefore, it is modelled as one synchronous generator, with its corresponding controllers, with a free governor's power reference, instead of

specified as in the case of Blocks 5 and 6. The synchronous generator (equivalent of the power system of Sweden) is connected to a 130kV bus.

#### 5.1.4 Wind turbines

The most recently installed wind turbines can contribute to frequency regulation. The rest, which are characterised by small capacity and old design, are uncontrollable. Therefore, they are forced to reduce their production, when the power system starts operating in the islanded mode, in order to avoid large frequency deviations due to wind power fluctuations.

In this work, the focus is put on the PV modelling and the objective is the analysis of PVs integration. Therefore, the developed models for the wind turbines are quite simple, without including any control function. As a result, all the wind turbines implemented in the model of the power system are regarded as uncontrollable. The wind turbines are grouped in wind farms installed in selected substation buses, considering data for their location. Each wind farm is modelled by one current source, meaning that there is not representation of each turbine separately, but of the whole power plant. The current injection of the source is set by the corresponding WF current component. This component takes the rms value of the current injection of the wind farm, as given from measurement data, and calculates the relative peak value. It also takes from the measurements the active and reactive power outputs of the wind farm and computes the power factor angle. This angle is added to the phase of the voltage at the bus where the wind farm is connected. The phase and the peak value of the current are given to a sinusoidal wave generator, which produces the three phases of the current given to the current source.

#### 5.1.5 Load

The load of the system is modelled as constant. Load components of constant impedance are implemented at all 10kV buses, representing the load of each substation. In general, it could be mentioned that a detailed model for representing a variable load is not essential for the sake of studies investigated in this project. The selection of short time frames for the simulations justifies the decision for constant load representation, as it is explained in 6.1.

### 5.2 Simulation platform

#### 5.2.1 RTDS

The objective of the project to investigate the impact of PV integration on the real-time operation of the power system requires the usage of a real-time simulation platform. The program that is used in this work is the Real Time Digital Simulator (RTDS), which is a fully digital power system simulator that allows power system simulations in real time, where an hour in the real world equals an hour in the simulator. This is achieved by the RTDS Simulator's parallel processing architecture. All calculations required to determine the power system's state for each time step are solved within a time step of real time. This means that the real-time simulator reads inputs, solves accurately model equations, produces internal variables, updates I/O devices and provides outputs of the simulation within the same length of time that its physical counterpart does. Therefore, the simulated model runs at the same rate as the actual physical system, ensuring a true replica of the real world signals [44, 45].

Moreover, the calculation of all internal variables in one time step allows simulations which can encompass results from DC up to electromagnetic transients. By using the RTDS, the simulation of components like synchronous generators, with slow response to electromechanical transients, and fast-switching power electronic devices, which connect the RES-based distributed

generation (PVs, wind turbines, etc.) to the grid, is achievable. Up until now, such studies in large grids were performed by off-line simulators, but the process was time consuming. With real-time simulators like RTDS, the overall stability and transient responses of the power system can be investigated in a timely matter. As a result, a wide variety of studies can be conducted in RTDS: the general power system operation including the behaviour of generations and transmission systems can be investigated, as well as the integration and operation of distributed generation and renewables. Furthermore, contingencies can be planned for and modelled and components interactions can be better analysed and understood [44, 45].

In addition, the software of RTDS allows the user's interaction with a real-time model, as it would be with the components of the actual power system. Through the graphical user interface, the libraries of power and control components and the component builder functionality that the software of RTDS provides, models can be created and integrated in power systems; via dials, data tables and sliders model inputs can be provided; model outputs can be gathered from meters and saved to external files managed by command scripts. However, real-time simulation is characterised by additional application attributes. For example, any model quantity can be monitored and therefore is accessible during simulation. In real power system components, getting a precise value of a quantity in real time is near impossible due to the prohibitive cost of meters. Moreover, online interaction with the simulated model is also achievable. This means that a model can be modified while is executed on the RTDS simulator, i.e. any model parameter can be read and updated continuously during simulation, which is not possible in a real power system component. The data accessibility and the possibility of online model configuration make previously unthinkable applications achievable [44, 45].

In the next paragraphs, specific aspects of RTDS software tools are discussed, since they constitute significant parts of the work performed during this project.

### 5.2.2 Issues on load flow results of current sources

The graphical user interface of RTDS provides power flow algorithms for the computation of the voltage at all terminals of the network and the determination of power dispatch among the units of the system. However, the current sources which represent the PV units and wind farms do not participate in the load flow algorithm. As a result, a special component is constructed and implemented for each current source; this LF component participates only in load flow algorithm in the place of each current source. Therefore, the power dispatch is calculated correctly amongst the units. On the contrary, during simulations this component does not contribute to results, but instead the unit is represented by the current source. In addition, this component saves the corresponding load flow results, in a similar way as voltage sources do, for their usage in the initialisation and stabilisation of dynamic models as explained in 5.2.3.

### 5.2.3 Issues on initialisation and stabilisation of dynamic models

When constructing a dynamic model in the component builder software tool of RTDS a thorough concern should be given for its proper initialisation. The procedure of initialisation moves backwards: voltage values at terminals and units' power outputs are calculated by the load flow algorithm; these units' outputs determine backwards the initial inputs that the units should have from their controllers; therefore, the initial output of every controller is defined. Then, according to this initial output, every quantity of the control models is initialised.

The initial values of variables act also as reference values for the proper stabilisation of the model during dynamic simulations. Hence, the value of each quantity, as calculated initially by

the load flow algorithm, is the reference value, meaning that the quantity should have this value when the system operates at its steady state.

Apart from all variables in the control models, states in mathematical functions, e.g. integration and first-order functions should also be initialised. The purpose of the initialisation of the state variables is that they should be kept unchanged in the steady-state operation of the model, without provoking any deviations from the reference values. When the model does not detect any disturbance from the system (steady-state operation), the state variables should provide the reference value of the output of the corresponding mathematical function. Thus, a set of equations is constructed for giving to the state variables their initial value according to the reference values of the variables in the dynamic model. RTDS provides with specific equations and initialisation functions for the proper initialisation of the state variables of the mathematical functions.

It should also be mentioned that except for the initialisation of all variables in the dynamic models, the output of the constructed controllers is forced to have its reference value when simulations start. This means that the PV and WF units will give their reference power output at the beginning of any simulation, independent of the input from the corresponding renewable source (power from PV panels and current from wind farms). Even if the first value of the renewable source input is not adequate to provide the reference value of output, the models are forced to provide this output for the initial stabilisation of the system in its steady state. After the stabilisation of the system at the beginning of the simulation, the control models start following the variations of the input (renewable source) and provide the appropriate output according to their control functions, in order to regulate frequency and voltage.

## 6. Simulation scenarios

### 6.1 Introduction

The simulation scenarios should be defined in a way so that they would be appropriate for investigating the selected impact factors, as mentioned in 3.3. Precisely, the scenarios should simulate such operating conditions, so that the effect of PVs on system's stability, power balance, frequency and voltage profiles can be quite large and therefore easily and clearly observed. Moreover, the simulated cases should be determined so that they prove the contribution of the constructed PV controllers to frequency and voltage regulation. The scenarios should also be thoroughly selected to represent realistic and variegated study cases.

For this purpose, the islanded operation mode of the power system of Bornholm is simulated. The reason for this is the exacerbation of issues regarding frequency and voltage stability in small and isolated grids, as explained in 5.1. Hence, more significant problems on frequency and voltage regulation are addressed, which could be overcome by enabling the PV controllers. Therefore, their contribution to power system stability is to be investigated.

It is noteworthy that the islanded conditions are not implemented initially; instead, a transition to islanded operation is performed. This occurs for the more realistic simulation of the system's operation. When the islanding conditions are initially implemented, all quantities in the system (power flows and terminal voltages) are initialised from load flow algorithm performed at the isolated system. Therefore, the reference values of all quantities refer directly to the isolated mode. Fluctuations around the reference values frequency and voltage are only caused due to the intermittent nature of PVs and wind farms. The existence of synchronous generators with their controllers would mitigate such variations quite easily and the contribution of PV controllers

would be found to be small and probably unobservable. In reality, the system initially operates in the interconnected mode and then is switched to the islanded mode. The load flow results have been calculated initially for the interconnected mode and the reference values have been determined accordingly. When the interconnection cable is switched off, active and reactive power flows through it are lost. In this case, frequency and voltage deviations are not caused only due to the variability of renewable sources, but also due to the cable outage. The controllers detect a severe disturbance and try to adjust the units' outputs to bring the power balance back. Hence, their contribution is much larger and thus can be clearly observed. It should be mentioned that this procedure would require also changes of the initial power reference values, through the secondary frequency control implemented in the system. In this way, the controllers would establish a new steady state for stable operation [1].

Apart from islanded operation, the rest of operating conditions should be determined by the simulation scenarios in such way so that they exacerbate the impact of PV on system's operation and therefore make clear the contribution of their controllers. The influence of PV integration on grid frequency depends on the ability of the system to maintain the active power fluctuations due to the intermittent power output of PVs. This ability relies on the power flow through the interconnection cable; when this is lost frequency regulation is based to the reserve margins of the system. Therefore, the interconnection cable outage is adequate operating condition to investigate the contribution of PV controllers to frequency regulation. On the other hand, the effect of PVs on the voltage profile of the buses to which they are connected depends not only on the power output of the PV unit, but also on the loading conditions of the bus. The injection of large amount of active power from a PV unit can lead to over-voltage situations in cases of low load conditions. On the contrary, under-voltage occasions could occur in cases of low power production from the PV unit, whereas simultaneously the power demand is high. Therefore, for analysing the possibility that such problematic situations could take place, various cases of loading conditions should be simulated.

For these system studies, the value ranges of voltage and frequency that ensure a stable operation of the system should also be determined. These value ranges can be found in grid codes and other literature references of system requirements, e.g. [1, 4, 22]. In the case of islanded power systems, like the Bornholm power system which is used in this project, the stability limits are set to be [49.9, 50.1] Hz for the frequency and [0.95, 1.05] p.u. for the voltage at 10kV buses.

The control models of PVs and the model used to represent the current from wind farms requires time series inputs, as described in 4.2.1 and 5.1.4. It should be mentioned that this input is the same for all RES-based units. This means that the controllers of all PV plants in the system have the same input of power from solar panels. The same occurs for the wind farms, namely the components that define the current injection of all wind farms take the same input. This is caused by the lack of information. The available measurements of the input of PV units refer to the power of panels installed in a building of CEE, DTU. Similarly, the available measurements of the wind farm current refer to the actual current injection of one wind farm in Åkikerby at the island of Bornholm. The lack of additional available measurements leads to the simplification of using the same input for all units of the same type. Therefore, it is assumed that solar irradiation and wind speed are exactly the same at all locations and imperfect correlation is ignored. As a result, the impact of spatial distribution of PVs and WFs on power fluctuations cannot be examined. For investigating the best distribution of PVs and WFs for various penetration levels, more accurate data for solar power and wind farm current should be used.

## 6.2 Description of scenarios

For the simulations two measurement scenarios are chosen. The scenarios are chosen to show the worst case so some of the steepest changes were identified. The first scenario is called fast on and is a change from zero to high production. The second is called peak and is a change from low to high and back to low again.

Both scenarios are run with a multiplier of 1, 2 and 3, which shows the reaction with current installed PV capacity and potential future PV penetration.

## 7. Results

The results are shown in Figure 4 to Figure 9. The peak frequency from all the simulation is summarised in Table 1. In the fast on scenario with a multiplier of 2 the frequency leaves the stability zone while with the peak scenario the frequency reaches the border of the zone.

Table 1 – Peak frequency

Multiplier	Fast on	Peak
1	50.07 Hz	50.05 Hz
2	50.14 Hz	50.10 Hz
3	50.20 Hz	50.15 Hz

Even though the peak power is higher in the peak scenario the fast on sees a higher frequency because of the faster change. The peak frequency should be lower in reality because the geographical spread of the PV production would slow down the change in production.

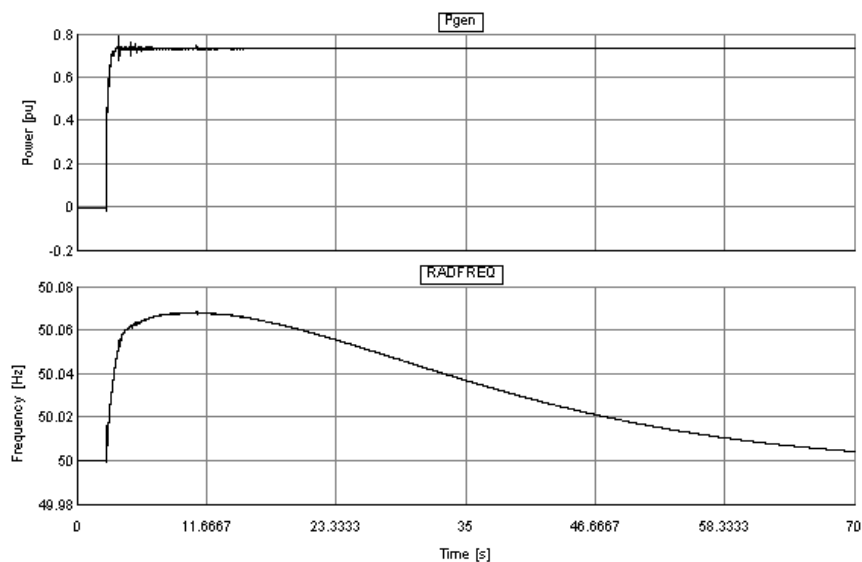
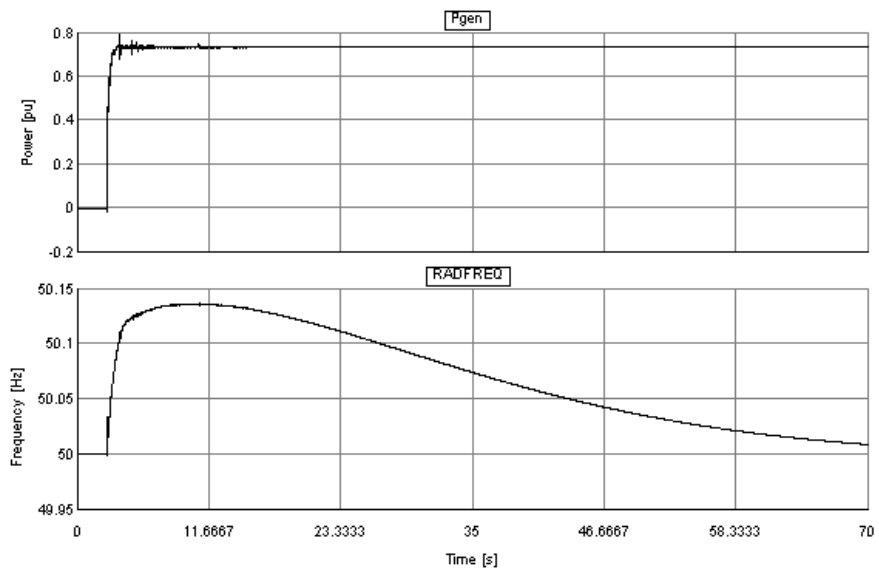
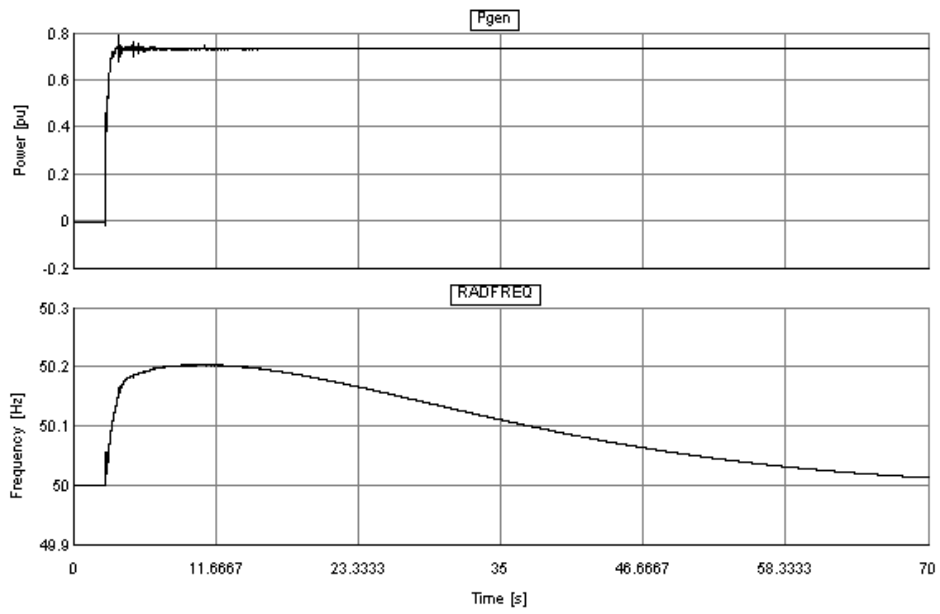

Figure 4 – Fast on, multiplier of 1



**Figure 5 – Fast on, multiplier of 2**



**Figure 6 – Fast on, multiplier of 3**

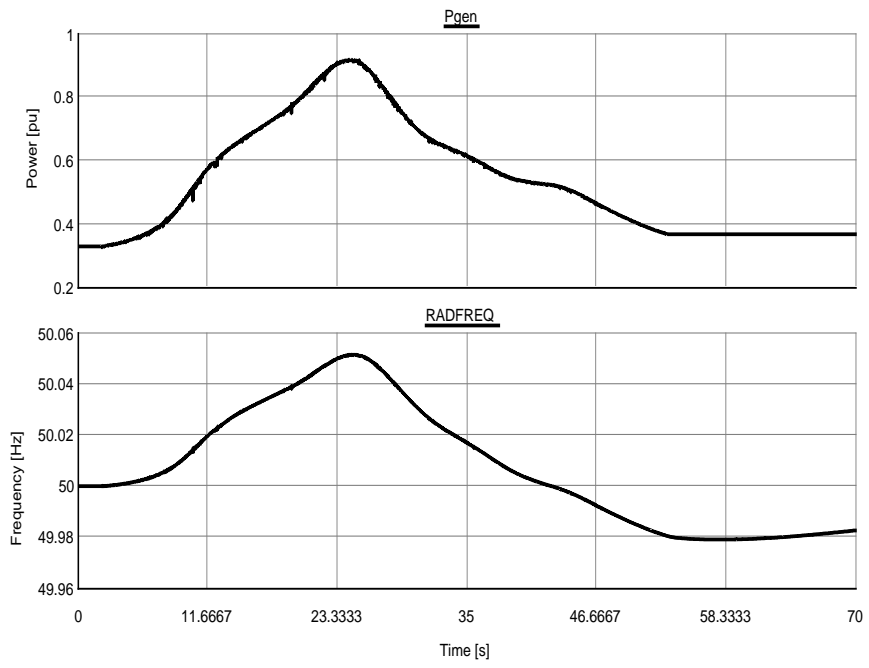
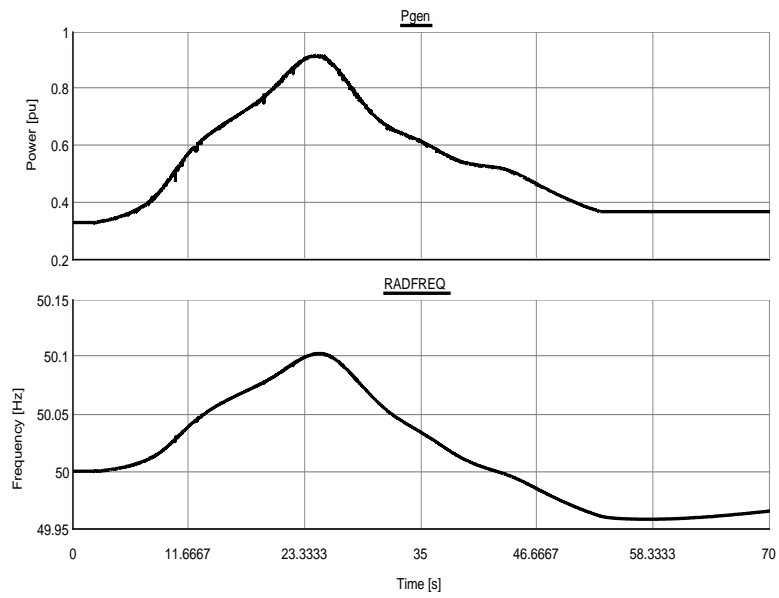
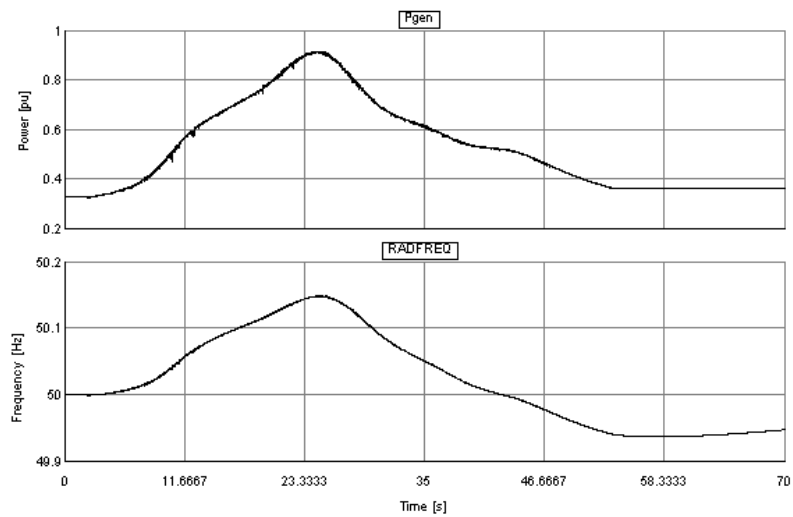

Figure 7 – Peak, multiplier of 1





**Figure 8 – Peak, multiplier of 2**



**Figure 9 – Peak, multiplier of 3**

## 8. References

- [1] A. Korompili. *Dynamic modelling of distributed generation for frequency and voltage regulation under high RES penetration*. MSc thesis, Technical University of Denmark, Department of Electrical Engineering, Centre for Electric Power and Energy, March 2013.
- [2] K. Rudion, Z. A. Styczynski, N. Hatziaegyriou, S. Papathanassiou, K. Strunz, O. Ruhle, A. Orths, and B. Rozel. Development of benchmark for low and medium distribution networks with high penetration of dispersed generation. In *Power Engineering Society General Meeting, 2006. IEEE*, pages 6 pp.–, 2006.
- [3] S. Aslanzadeh and S. Jamali. Study of distributed generation type and islanding impact on the operation of radial distribution systems. In *Universities Power Engineering Conference, 2007. UPEC 2007. 42nd International*, pages 1216–1221, 2007.
- [4] Y. Chen. *Control Architecture for Intentional Island Operation in Distribution Network with High Penetration of Distributed Generation*. PhD thesis, Technical University of Denmark, Department of Electrical Engineering, Centre for Electric Technology, September 2010.
- [5] A. F. Sarabia. *Impact of distributed generation on distribution system*. PhD thesis, Aalborg University, Faculty of Engineering, Science and Medicine, Department of Energy Technology, June 2011.
- [6] R. Al-Abri. *Voltage Stability Analysis with High Distributed Generation (DG) Penetration*. PhD thesis, University of Waterloo, Department of Electrical and Computer Engineering, 2012.
- [7] F. Katiraei and J.R. Aguero. Solar PV integration challenges. *Power and Energy Magazine, IEEE*, 9(3):62–71, 2011.
- [8] A. Keane. *Integration of Distributed Generation*. PhD thesis, University College Dublin, School of Electrical, Electronic & Mechanical Engineering, January 2007.
- [9] T. Lund. *Analysis of distribution systems with a high penetration of distributed generation*. PhD thesis, Technical University of Denmark, Ørsted Institute, Department of Electrical Engineering, Centre for Electric Technology, September 2007.
- [10] M. Braun, T. Stetz, T. Reimann, B. Valov, and G. Arnold. Optimal reactive power supply in distribution networks - technological and economic assessment for PV-systems. In *24th European Photovoltaic Solar Energy Conference and Exhibition*, Hamburg, September 2009.
- [11] M.E. Baran, H. Hooshyar, Zhan Shen, and A. Huang. Accommodating high PV penetration on distribution feeders. *Smart Grid, IEEE Transactions on*, 3(2):1039–1046, 2012.
- [12] R.A. Shayani and M.A.G. de Oliveira. Photovoltaic generation penetration limits in radial distribution systems. *Power Systems, IEEE Transactions on*, 26(3):1625–1631, 2011.
- [13] R. Tonkoski, D. Turcotte, and T. H. M. EL-Fouly. Impact of high PV penetration on voltage profiles in residential neighbourhoods. *Sustainable Energy, IEEE Transactions on*, 3(3):518–527, 2012.
- [14] M. Thomson and D.G. Infield. Impact of widespread photovoltaics generation on distribution systems. *Renewable Power Generation, IET*, 1(1):33–40, 2007.

- [15] Ruifeng Yan and T.K. Saha. Investigation of voltage stability for residential customers due to high photovoltaic penetrations. *Power Systems, IEEE Transactions on*, 27(2):651–662, 2012.
- [16] M. J. Hossain, T. K. Saha, and N. Mithulananthan. Impacts of wind and solar integrations on the dynamic operations of distribution systems. In *Universities Power Engineering Conference (AUPEC), 2011 21st Australasian*, pages 1–6, 2011.
- [17] A. Ellis, R. Nelson, E. von Engeln, R. Walling, J. McDowell, L. Casey, E. Seymour, W. Peter, C. Barker, and B. Kirby. Reactive power interconnection requirements for PV and wind plants. Recommendations to NERC. Sandia report, Sandia National Laboratories, February 2012.
- [18] C. L. DeMarco, C. A. Baone, Y. Han, and B. Lesieutre. Primary and secondary control for high penetration renewables. In *PSERC Webinars on Issues in Designing the Future Grid, 2012. Power Systems Engineering Research Center 2012*, March 2012.
- [19] B. Robyns, J. Sprooten, and A. Vergnol. Supervision of renewable energy for its integration in the electrical system. In *Power and Energy Society General Meeting, 2010. IEEE*, July 2010.
- [20] H. Bevrani, A. Ghosh, and G. Ledwich. Renewable energy sources and frequency regulation: survey and new perspectives. *Renewable Power Generation, IET*, 4(5):438–457, February 2010.
- [21] M. Vandenberg, D. Craciun, V. Helmbrecht, R. Hermes, R. Lama, P. M. Sonvilla, M. Reisinger, and G. Concas. PRIORITIZATION OF TECHNICAL SOLUTIONS AVAILABLE FOR THE INTEGRATION OF PV INTO THE DISTRIBUTION GRID. DERlab PVGRID report, Version 12, May 2013.
- [22] P. Nyeng, K. O. H. Pedersen, and J. Østergaard. Ancillary services from distributed energy resources - perspectives for the Danish power system. In *IYCE 2007 Conference, 2007*.
- [23] L. Zeni. *Dynamic model of a CHP plant and its application to frequency control on island power system with high penetration of wind power*. Master thesis, Risø National Laboratory for Sustainable Energy - Technical University of Denmark, Department of Mechanical Engineering, Department of Electrical Engineering, Centre for Electric Technology, June 2010.
- [24] A. D. Hansen, P. Sørensen, F. Iov, and F. Blaabjerg. Grid support of a wind farm with active stall wind turbines and AC grid connection. *Wind Energy*, 9(4):341-359, 2006.
- [25] K. Clark, N. W. Miller, and R. Walling. Modelling of GE solar photovoltaic plants for grid studies. Technical Report Version 1.1, General Electric International, Inc., April 2010.
- [26] N. Okada and K. Takigawa. A voltage regulation method for dispersed grid-connected PV systems under high-density connection. *Elsevier, Solar Energy Materials and Solar Cells*, 75(3-4):637-646, 2003.
- [27] D. Sera. Modelling, diagnostics and monitoring for PV arrays. In *1st International workshop on integration of solar power into power systems*.
- [28] C. Adrian, L. D. Radu, and Søren B. K. Voltage control in low voltage networks by photovoltaic inverters - case study Bornholm. Technical report, Danfoss solar inverters A/S - PVNET.dk, December 2012.
- [29] R.A. Mastromauro, M. Liserre, T. Kerekes, and A. Dell'Aquila. A singlephase voltage controlled grid-connected photovoltaic system with power quality conditioner functionality. *Industrial Electronics, IEEE Transactions on*, 56(11):4436–4444, 2009.

- [30] J.C. Vasquez, R.A. Mastromauro, J.M. Guerrero, and M. Liserre. Voltage support provided by a droop-controlled multifunctional inverter. *Industrial Electronics, IEEE Transactions on*, 56(11):4510–4519, 2009.
- [31] J.W. Smith, W. Sunderman, R. Dugan, and B. Seal. Smart inverter volt/- var control functions for high penetration of PV on distribution systems. In *Power Systems Conference and Exposition (PSCE), 2011 IEEE/PES*, pages 1–6, 2011.
- [32] K. Clark, N. W. Miller, and J. J. Sanchez-Gasca. Modelling of GE wind turbine-generators for grid studies. Technical Report Version 4.5, General Electric International, Inc., April 2010.
- [33] N.W. Miller and K. Clark. Advanced controls enable wind plants to provide ancillary services. In *Power and Energy Society General Meeting, 2010. IEEE*, pages 1–6, July 2010.
- [34] V. Akhmatov. *Analysis of dynamic behaviour of electric power systems with large amount of wind power*. PhD thesis, Technical University of Denmark, Ørsted Institute, Department of Electrical Engineering, Centre for Electric Technology, April 2003.
- [35] A. Garcia and J. Østergaard. Analysis of electric networks in island operation with a large penetration of wind power. In *Proceedings Nordic Wind Power Conference NWPC: Risø National Laboratory for Sustainable Energy*, 2007.
- [36] P. Rosas. *Dynamic Influences of Wind Power on the Power System*. PhD thesis, Technical University of Denmark, Ørsted Institute, Department of Electrical Engineering, Centre for Electric Technology, March 2003.
- [37] D. Mayer, L. Wald, and Pelland S. Poissant, Y. Performance prediction on grid-connected photovoltaic systems using remote sensing. Technical report, International Energy Agency - Photovoltaic Power Systems Programme, March 2008.
- [38] C. Koch-Ciobotaru, L. Mihet-Popa, F. Isleifsson, and H. Bindner. Simulation model developed for a small-scale PV-system in a distribution network. In *8th International Symposium on Applied Computational Intelligence and Informatics-SACI 2012*, Timisoara, Romania, May 2012.
- [39] L. Mihet-Popa, C. Koch-Ciobotaru, F. Isleifsson, and H. Bindner. Development of tools for DER components in a distribution network. In *Electrical Machines (ICEM), 2012 XXth International Conference on*, pages 2072–2078, 2012.
- [40] P. Pourbeik. Proposed changes to the WECC WT4 generic for type 4 wind turbine generators. Technical report, Electric Power Research Institute (ERPI), December 2011.
- [41] V. Akhmatov. Bornholm power system model: load-flow and state estimation using DIgSILENT PowerFactory. Client user manual, Technical University of Denmark, July 2009.
- [42] J. E. Nielsen. The Bornholm power system. Technical report, Technical University of Denmark, January 2008.
- [43] J. E. Nielsen. The Bornholm power system: the 60kV network. Technical report, Technical University of Denmark, April 2008.
- [44] RTDS Technologies Inc. RTDS Corporate Brochure, Available online at: <http://www.rtds.com>.
- [45] J. Belanger, P. Venne, and J.-N. Paquin. The What, Where and Why of Real-Time Simulation. Technical document, OPAL-RT Technologies. Available online at: [http://www.opal-rt.com/technical\\_documents](http://www.opal-rt.com/technical_documents), October 2010.