



Night time cooling by ventilation or night sky radiation combined with in-room radiant cooling panels including phase change materials

Bourdakis, Eleftherios; Olesen, Bjarne W.; Grossule, Fabio

Publication date:
2015

Document Version
Peer reviewed version

[Link back to DTU Orbit](#)

Citation (APA):

Bourdakis, E., Olesen, B. W., & Grossule, F. (2015). *Night time cooling by ventilation or night sky radiation combined with in-room radiant cooling panels including phase change materials*. Paper presented at 36th AIVC Conference, Madrid, Spain.

General rights

Copyright and moral rights for the publications made accessible in the public portal are retained by the authors and/or other copyright owners and it is a condition of accessing publications that users recognise and abide by the legal requirements associated with these rights.

- Users may download and print one copy of any publication from the public portal for the purpose of private study or research.
- You may not further distribute the material or use it for any profit-making activity or commercial gain
- You may freely distribute the URL identifying the publication in the public portal

If you believe that this document breaches copyright please contact us providing details, and we will remove access to the work immediately and investigate your claim.

Night time cooling by ventilation or night sky radiation combined with in-room radiant cooling panels including Phase Change Materials

Eleftherios Bourdakis¹, Bjarne W. Olesen^{*1}, Fabio Grossule¹

¹*Technical University of Denmark
International Centre for Indoor Environment and Energy
Nils Koppels Allé, Building 402
Kongens Lyngby, Denmark
* bwo@byg.dtu.dk*

ABSTRACT

Night sky radiative cooling technology using PhotoVoltaic/Thermal panels (PVT) and night time ventilation have been studied both by means of simulations and experiments to evaluate their potential and to validate the created simulation model used to describe it. An experimental setup has been constructed at the Technical University of Denmark, where the outside PVT panels are connected through a storage tank to in-room radiant ceiling panels. The radiant ceiling panels include phase change material (PCM) and embedded pipes for circulating water. Due to the phase change material it is possible to store the heat generated during the day from internal sources. Then during the night the panels can be cooled down again and regenerated. The possibility of cooling down the panels during the night with outside air was also studied. The night cooling power of the PVT panels ranged from 92 to 119 W/m² depending on the sky clearness. This cooling power was enough to remove the stored heat and regenerate the ceiling panels. The validation simulation model results related to PCM were close to the corresponding results extracted from the experiment, while the results related to the production of cold water through the night sky radiative cooling differed significantly. The possibility of night time ventilation was studied through simulations for three different latitudes. It was concluded that for Danish climatic conditions night time ventilation would also be able to regenerate the panels while its contribution is not sufficient in warmer South-European climates.

KEYWORDS

Night Time Ventilation, Night Sky Radiative Cooling, Phase Change Materials, Thermal Comfort, Renovation

1 INTRODUCTION

World energy consumption has been increasing rapidly the last decades, mainly due to the population growth and the industrial and technological development. In order to address this issue, European Union (EU) has put into force the agreement “20-20-20” (European Commission, 2007), which sets several ambitious targets to be met from the member states by the year 2020.

According to the International Energy Agency (IEA) (2013), energy consumption in buildings accounts for more than 40% of the primary energy consumption in many IEA member states. Therefore, vast changes have to be made in the building sector and especially in the Heating, Ventilation and Air-Conditioning (HVAC) systems, in order to reach the aforementioned targets. Most of the buildings which will exist by the year 2020 have already been built, since a building has a life span of more than 50 years. Thus, much effort must be put into retrofitting existing buildings.

One solution that could contribute in reducing the energy consumption caused by HVAC systems is the Thermo Active Building Systems (TABS). Main advantages of TABS are the distribution of cooling over a longer period which results in reduced peak loads, reduction in the buildings materials due to the reduced suspended ceiling for ventilation

purposes since the required air flow rate is reduced. Moreover, the fact that the cooling temperature is close to room temperature increases the energy efficiency of heat pumps and ground heat exchangers (Babiak et al., 2007). Many modern office buildings in Europe are using TABS to store heat in the slabs during the day and remove the stored heat during the night (Kolarik et al., 2015).

Nevertheless, this system is in most cases not applicable for energy renovation of buildings. A solution that could be effective in cases of buildings renovation is a radiant cooling system with the implementation of Phase Change Material (PCM) since it has the benefits of a heavyweight construction with the thickness of a lightweight construction (Koschenz & Lehmann, 2004). PCMs are organic or inorganic substances that absorb heat while melting and release it while solidifying. The most important advantages of the implementation of PCMs in the structure, as they have been reported in the literature (Cabeza et al., 2007; BASF, 2010; Pavlov, 2014; Grossule, 2015), are the improved thermal inertia compared to conventional concrete, the reduction of peak cooling load, the shift of part of the cooling demand to night time where lower electricity prices occur, the attenuation of the interior air temperature fluctuations and the reduction of the size of the HVAC system.

One passive method that could be utilized for discharging the PCM is the night sky radiative cooling. During night time the effective sky temperature is lower than the one of the solar panels surface, therefore the panels release heat in the form of radiation towards the atmosphere (Meir et al., 2002). There are several ways with which night sky radiative cooling can be exploited (Grossule, 2015), but in this study only a closed water based system will be examined. The advantages of such a system are the reduction of energy consumption, since the only energy required is that for the water pumps, a higher utilization factor for solar thermal panels is achieved since they are exploited also during night time, cooling demand and cold water production through night sky radiative cooling are in phase since clear sky occurs more often during summer time and it can be coupled with thermal storage materials like PCM (Meir et al., 2002; Eicker & Dalibard, 2011; Hosseinzadeh & Taherian, 2012). Another passive method that could be exploited is the night time natural ventilation when the ambient air temperature is low enough.

The purpose of this study was to examine and evaluate different methods for discharging the PCM, and to couple the PCM with solar panels for discharging it passively through night sky radiative cooling. The results of the experiment were used to validate the corresponding simulation model, which was then used to simulate the possibility of discharging the PCM by exploiting night time ventilation under Copenhagen's, Milan's and Athens' weather conditions.

2 EXPERIMENT

2.1 Experimental setup

For the purpose of the experiments a climatic chamber at the facilities of the International Centre for Indoor Environment and Energy (ICIEE) was used. The floor surface was 22.7 m^2 and the height from the floor to the suspended ceiling 2.5 m. The walls and the roof are made of two steel sheets separated by 10 cm of mineral wool for insulation, while the whole chamber is not exposed directly to the ambient weather conditions since it is enclosed in a bigger building.

The suspended ceiling consisted from panels made from a mixture of clay with 26% of PCM by weight. The PCM used was the type DS 5040X produced from BASF with melting point of 23°C (BASF, 2010). As it is shown in Figure 1, above the PCM ceiling panels there was a 0.5 m height plenum, from where the ventilation air was supplied in the chamber through the gaps between the ceiling panels. For discharging the PCM, the ceiling panels had embedded pipes inside for circulating water during night time. The chamber was designed

accordingly to simulate a two-person office, with the use of heat dummies for the occupants and the equipment. Therefore, the heat dummies were activated during typical office hours, namely from 9:00 to 17:00. The total power of the heat gains was 540 W.

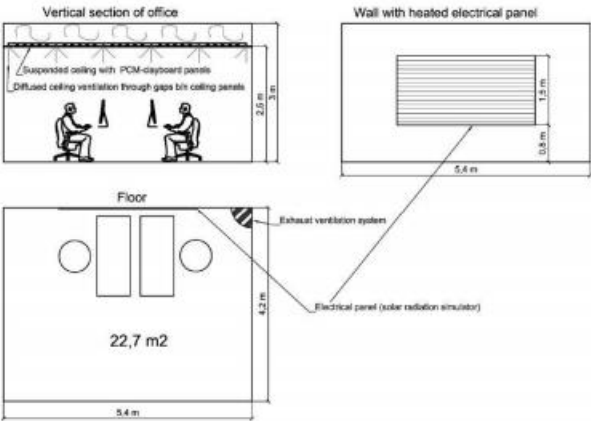

Figure 1: Chamber's layout (Pavlov, 2014)



Figure 2: Experimental Setup (Grossule, 2015)

The ventilation flow rate was set to 30 l/s, sized according to Annex B.1.2 of the standard DS 15251 (2007) for removing pollutants and providing fresh air, counting only on the performance of the PCM for removing the heat. The air supply temperature was set to 18.5°C. As in the case of the heat dummies, the ventilation was operating from 9:00 to 17:00. The exhaust of the ventilation can be seen in the far corner of the chamber in Figure 2. In the second experimental case the ventilation was also used from 22:00 to 06:00 as a method for discharging the PCM.

For the simulation of the solar heat gains, an electrical heating panel was used on the wall which was supposed to be facing south, as it can be seen in Figure 2. The schedule of the solar heat gains is illustrated in Figure 3.

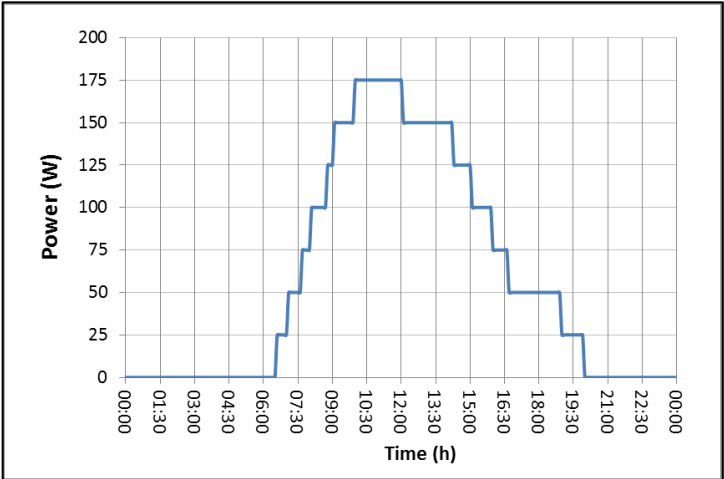

Figure 3: Daily solar heat gains profile

The second method used for discharging the PCM was by circulating water to the embedded pipes during night time. In experiment 1 the cold water was directly supplied from the main chiller of the laboratory's facilities. In experiment 2 the system was upgraded with

the implementation of 3 PhotoVoltaic/Thermal (PVT) panels for the production mainly of cold water, by circulating water in the PVT panels during night time. In this study the production of hot water and electricity was not taken into consideration. Each PVT panel had a surface area of 1.3 m², a tilt angle of 45° and they were facing south.

The PVT panels were connected with two storage tanks through a heat exchanger. Both tanks had a volume of 255 l and the one was used for storing cold water (CWT) while the other one for storing hot water (HWT). The reason why a heat exchanger was installed in between was due to different settings required in the PVT panels and the tanks regarding water pressure. Furthermore, in this way a smaller quantity of glycol was required which was used as antifreeze. The water from the heat exchanger was circulated to a heat exchanger enclosed in the upper part of the CWT, while a second enclosed heat exchanger was connected with the main chiller of the laboratory's facilities. The main chiller was used as an ancillary system for ensuring the production of cold water in case where the production from the night sky radiative cooling was not enough. The water from the bottom of the CWT was circulated to the PCM panels and from there it was returned to the top of the CWT. In Figure 4 the schematic drawing of the hydraulic system is presented.

In both cases (water provided either from the main chiller or the CWT) the circulation of the water would start at 20:00 and would continue until 7:30 if none of the two following conditions was met earlier:

- The average bottom surface temperature of the PCM panels dropped below 21°C
- The operative temperature of the room dropped below 21°C

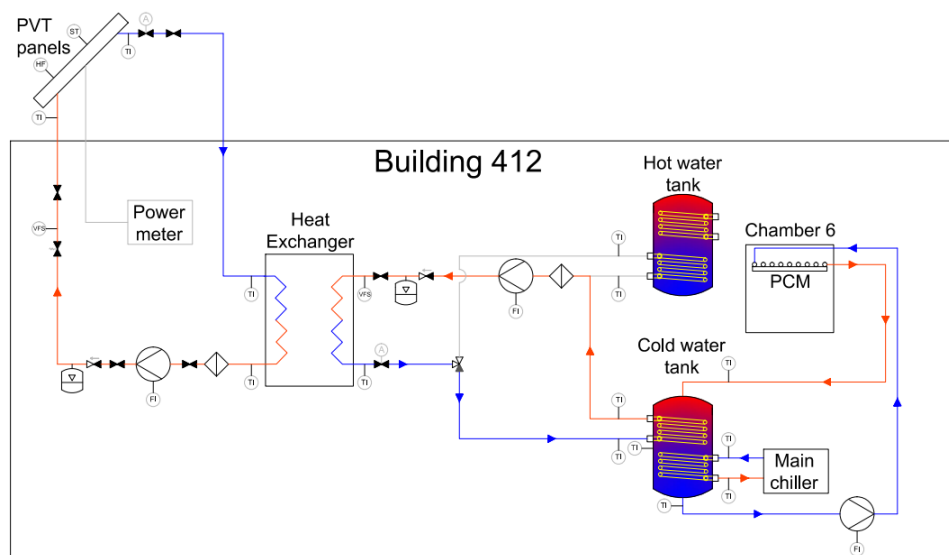

Figure 4: Schematic drawing of the hydraulic system

2.2 Experiment 1

As it was mentioned before, for experiment 1 the cold water for discharging the PCM was provided from the main chiller of the laboratory. Four cases were examined in the first experiment; the first two cases were identical to the cases A1 and B1 examined by Pavlov (2014), in order to ensure that the system works in the same way. In the third case the embedded pipes were used for discharging the PCM and two floor fans were installed in the corners to examine the impact of improved air mixing in the operative temperature and the PCM bottom surface temperature. Lastly, in the fourth case the two desks with the heat dummies were placed closer to the centre of the room and then split towards the walls, in order to distribute the heat sources more evenly in the room. The settings for the four cases are presented in Table 1. Each experimental case lasted four days.

Table 1: Examined cases of experiment 1

Case	Night ventilation (22:00 – 6:00)	Water air flow
1	Off	0.15 m ³ /h
2	62 l/s	Off
3	Off	0.15 m ³ /h
4	Off	0.15 m ³ /h

2.3 Experiment 2

For the second experiment two cases were examined. In the first one the air temperature inside the chamber was kept constantly at 26°C from 9:00 to 18:00, while in the second case it was kept constantly at 28°C for the same time period. During the rest of the day the ventilation was deactivated. In this experiment the heat dummies and the solar panel were deactivated and the room air temperature was controlled through the ventilation system. Each case lasted for three days.

2.4 Simulation study

The results extracted from experiment 2 were compared with a simulation model made in TRNSYS 17, in order to validate it. In order for the simulation model to be more accurate, the extracted data from a weather station installed next to the PVT panels were used as an input to the PVT component in the simulation model. All the rest of the settings of the simulation model were as close as possible to the conditions of experiment 2. Afterwards, the model was used for simulating the possibility of exploiting night time ventilation for discharging the PCM under the weather conditions of Copenhagen, Milan and Athens. The night time flow rate that was used was 62 l/s as it was set in the second case of experiment 1, while the air supply temperature was the ambient air temperature. The period simulated was the whole cooling period, namely from 1st of May until the 30th of September.

3 RESULTS

3.1 Experiment 1 results

In the Figure below the operative temperature in the interior of the chamber during the four examined cases of experiment 1 is presented. As it can be seen, both the improvement of the air mixing (case 3) and the separation of the internal heat sources (case 4) caused a reduction in the peak temperature during the occupancy period.

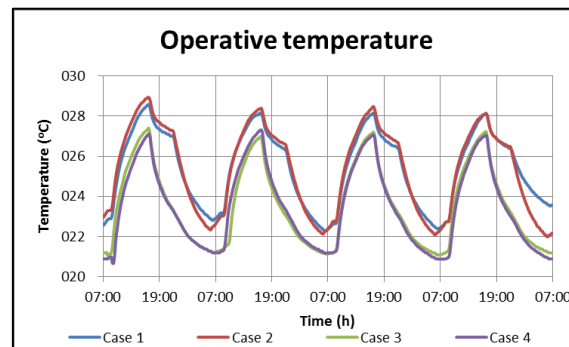

Figure 5: Operative temperature of experiment 1

In Figure 6 the temperature of the bottom surface of the PCM panels is presented. As before, a reduction in the peak temperature is observed in cases 3 and 4. Furthermore, the minimum surface temperature is lower in these two cases, which means that a higher

percentage of PCM was discharged during the night time. On the other hand, the examined combination of air supply volume and temperature during night time proved to be insufficient for discharging the PCM completely.

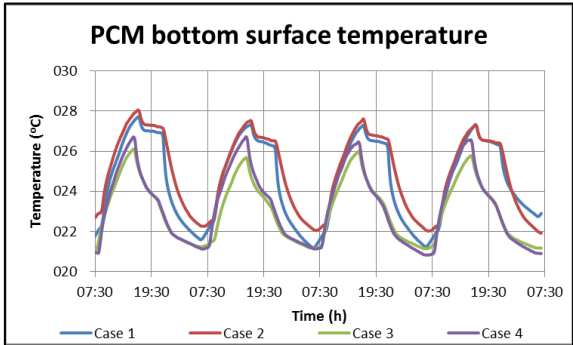

Figure 6: Bottom surface temperature of the PCM panels

One of the drawbacks of PCMs is their low thermal conductivity. In order to examine the impact of the changes examined during cases 3 and 4 to the energy absorbed by the PCM, the percentage of the utilised PCM was calculated. For this calculation the bottom and the top PCM surface temperatures were used, and the results can be seen in Table 2. As it can be seen the changes implemented in case 3 and 4 increased the percentage of the utilised PCM.

Table 2: Percentage of PCM utilization level

	Case 1	Case 2	Case 3	Case 4
Percentage of PCM utilized (%)	90.8	78.1	95.1	96.7

3.2 Experiment 2 and validation simulations results

The results from the second experiment will be presented in the following figures combined with the results from the validation simulations, in order to be compared directly. In Figure 7 the air temperature at height 0.6 m and the operative temperature from a representative experimental day of case 1 are presented. As it can be seen the results from the simulation match satisfactorily with the results extracted from the corresponding experiment case. In Figure 8 the average temperature of the bottom surface of the PCM panels is presented. As before, the two results are satisfactorily close. The three spikes that are observed in the simulation curve in the morning were caused by the fact that a deadband was not implemented.

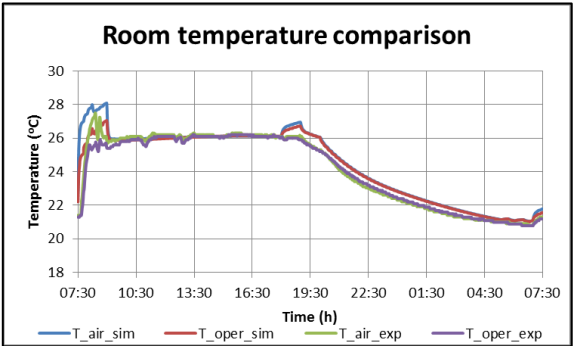

Figure 7: Air and operative temperature of simulation and experiment for case 1

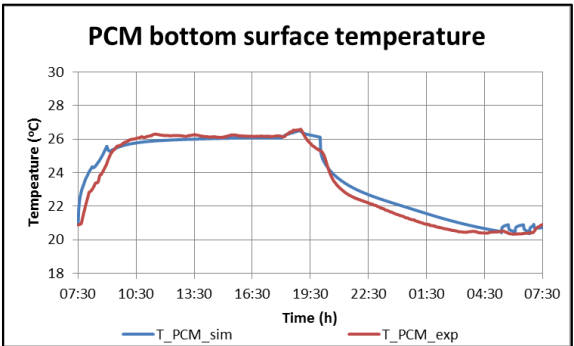

Figure 8: Bottom surface temperature of PCM panels of simulation and experiment for case 1

In Figure 9 the air temperature at height 0.6 m and the operative temperature from a representative experimental day of case 2 are shown. The downwards pikes that are observed in the experiment curves were caused by the opening of the door of the chamber. In Figure 10 the average temperature of the bottom surface of the PCM panels is presented. As in the previous case, the pike at the end of the curve is caused by the absence of a deadband. From both Figure 9 and Figure 10 it can be seen that the simulation results of case 2 matched to a large extent with the results from the corresponding experimental case.

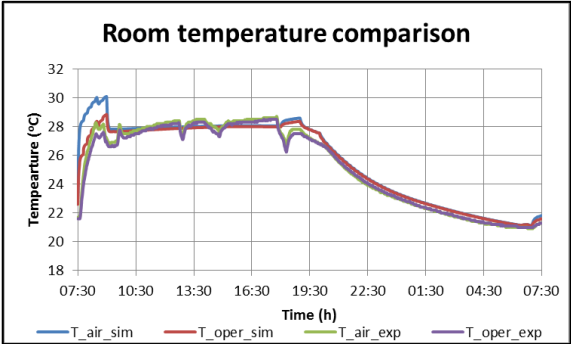

Figure 9: Air and operative temperature of simulation and experiment for case 2

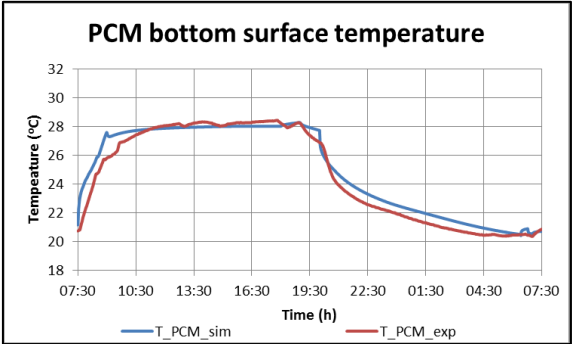

Figure 10: Bottom surface temperature of PCM panels of simulation and experiment for case 2

In the figures below the average specific cooling power of each night of the second experiment and the corresponding energy that was released towards the atmosphere are presented. As it can be seen, the results extracted from the simulations are underestimated compared to those extracted from the experiment.

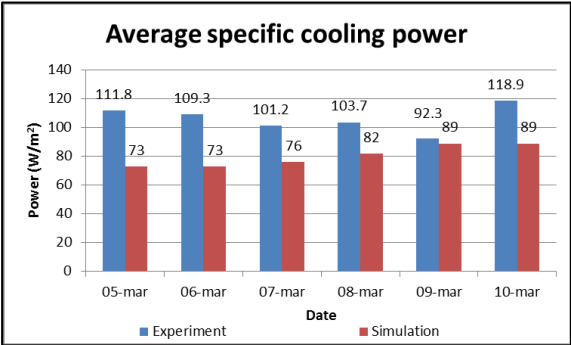

Figure 11: Average specific cooling power

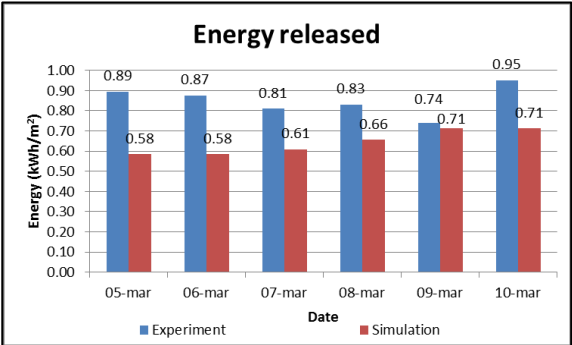

Figure 12: Energy released towards the atmosphere

The reason why this inaccuracy was observed was caused by the effective sky temperature values implemented in the TRNSYS model. Since this parameter was not possible to be measured by the weather station, a theoretical calculation was used as it is described by Grossule (2015) in Appendix 12.1.3.

Moreover, the cooling output is affected by the difference between the water temperature entering and exiting the PVT panels. As it can be seen in **Error! Reference source not found.** the ΔT in the case of simulation is significantly lower compared to the case of the experimental results.

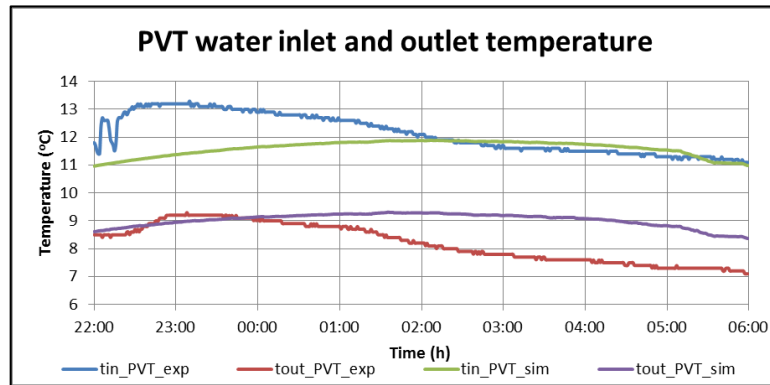

Figure 13: Water inlet and outlet temperature at the PVT panels

3.3 Simulation study results

In Table 3 the performance of the office room in terms of operative temperature in the three simulated location is presented. At this point, it should be reminded that standard DS 15251 requires the 95% of the occupancy period to be within the range 23.5 – 25.5°C, 23 – 26°C or 22 – 27°C in order for a building to be evaluated as category I, II or III respectively. The presented results are the percentages in which the operative temperature was within the suggested range. It can be observed that Athens had the best thermal performance out of the three examined locations, but it was still not good enough for satisfying the requirements for category III of standard DS 15251.

Table 3: Operative temperature performance based on standard DS 15251

	Category I (23.5 – 25.5°C)	Category II (23 – 26°C)	Category III (22 – 27°C)
COP	25%	39%	43%
MIL	28%	42%	46%
ATH	29%	42%	72%

In Figure 14 the daily average performance of the PCM is illustrated. The percentage of charged PCM refers to the end of the occupancy period, namely shows the percentage of PCM that was utilized during that period. On the other hand, the percentage of the discharged PCM refers to the beginning of the occupancy period, thus it reflects the percentage that is still not discharged after the night time ventilation. It can be seen that while in Copenhagen and Milan PCM was almost fully discharged, in the case of Athens approximately the one third of it was not discharged.

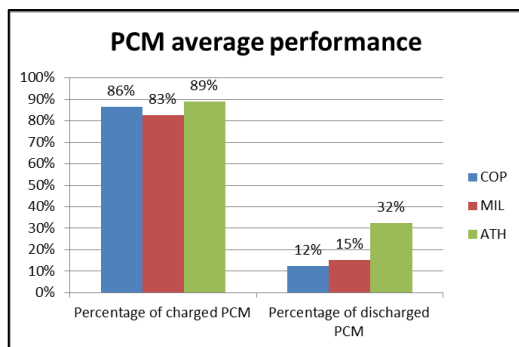

Figure 14: Average daily percentage of charged and discharged PCM

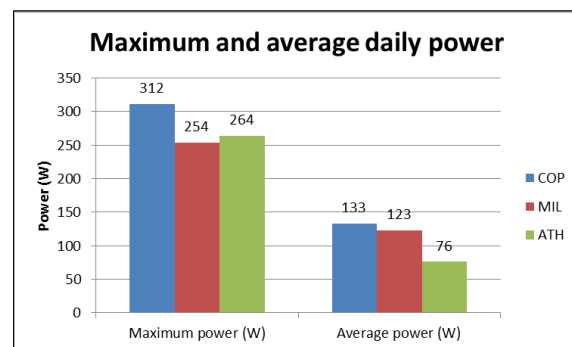

Figure 15: Maximum and daily average power

In Figure 15 the maximum and the daily average cooling power are presented. As it can be seen, although the maximum cooling power in Athens is comparable with the one of Copenhagen, the daily average cooling power of Athens is approximately the half of the one of Copenhagen. The corresponding results of Milan are closer to the results of Copenhagen than those of Athens.

4 DISCUSSION

Regarding the experiment 1, the calculation regarding the percentage of utilization is just an indication, since the temperature distribution inside the panels is not known. This can be observed from the values for cases 1 and 2, which were expected to be closer, since the interior of the experiment was identical. Since the air flow rate that was examined as a discharging method proved to be insufficient for discharging the PCM panels, a higher air flow rate could be examined, or a lower air supply temperature. A lower supply temperature would be feasible in northern European climate areas, but not in Mediterranean climate areas.

The second experiment was conducted during March 2015, a period in which the ambient weather conditions were in favour for producing cold water through night sky radiative cooling. Thus, the experiment should be repeated during summer time, when it is expected that the cooling demand would be higher and the ambient air temperature as well.

The reason why Copenhagen performed worse than Milan and Athens in terms of thermal environment was the low position of the sun which increased significantly the solar heat gains in this location. The same simulations should be repeated with the implementation of a solar shading system.

5 CONCLUSIONS

In this study two experiments were conducted to examine the performance of a radiant ceiling cooling system with PCM combined with PVT panels for discharging the PCM passively, while the results extracted from the second experiment were used to validate the corresponding TRNSYS simulation model. The validated model was used to simulate in three different locations the possibility of discharging the PCM by exploiting night time ventilation.

From the first experiment it can be concluded that the circulation of water in the embedded pipes is more effective in discharging the PCM compared to the tested night time ventilation flow rate. Furthermore, it can be concluded that the location of the PCM compared to the heat gain sources affects significantly the performance of the PCM. Therefore, special attention has to be given when designing a cooling system which includes PCM.

From the second experiment it can be concluded that the cold water produced through the night sky radiative cooling was sufficient for discharging the PCM for both examined cases. On the other hand, since – as it was mentioned before – the experiment was conducted during March, this discharging method should also be examined during summer time or ideally during a whole year in order to have a more comprehensive view of the performance of the PVT panels. In order to have the complete performance of the PVT panels, also the production of hot water and electricity needs to be taken into consideration.

Regarding the simulation model, the part simulating the chamber with the PCM ceiling panels proved to be satisfactorily accurate, while the solar loop containing the PVT panels needs to be further investigated and improved. The model should be compared with an experiment conducted during summer time for a more complete and accurate validation.

From the simulation study it can be concluded that the night time ventilation can be exploited for discharging the PCM passively in areas with Nordic climate but is insufficient for Mediterranean climate conditions.

6 REFERENCES

- Babiak, J., Olesen, B. W., & Petráš, D. (2007). *Low temperature heating and high temperature cooling* (2nd ed., Vol. 7). Forssa, Finland: Forssan Kirjapaino Oy.
- BASF. (2010). *Micronal ® PCM Intelligent temperature management for buildings*. Ludwigshafen, Germany: BASF.
- Cabeza, L. F., Castellón, C., Nogués, M., Medrano, M., Leppers, R., & Zubillaga, O. (2007). Use of microencapsulated PCM in concrete walls for energy savings. *Energy and Buildings*, 39(2), 113 - 119.
- Dansk standard. (2007). *DS 15251 Indoor environmental input parameters for design and assessment of energy performance of buildings addressing indoor air quality, thermal environment, lighting and acoustics*. Charlottenlund, Denmark: Dansk Standard.
- Eicker, U., & Dalibard, A. (2011). Photovoltaic–thermal collectors for night radiative cooling of buildings. *Solar Energy*, 85(7), 1322 - 1335.
- European Commission. (2007). *The EU climate and energy package*. Retrieved June 30, 2015, from http://ec.europa.eu/clima/policies/package/index_en.htm
- Grossule, F. (2015). *The use of phase change materials for cooling of buildings combined with night sky radiant cooling*. Kongens Lyngby, Denmark: Technical University of Denmark.
- Hosseinzadeh, E., & Taherian, H. (2012). An experimental and analytical study of a radiative cooling system with unglazed flat plate collectors. *International Journal of Green Energy*, 9, 766 - 779.
- International Energy Agency. (2013). *Modernising Building Energy Codes to secure our Global Energy Future: Policy Pathway*. Retrieved 6 26, 2015, from <http://www.iea.org/publications/freepublications/publication/policy-pathways-modernising-building-energy-codes.html>
- Kolarik, J., Toftum, J., & Olesen, B. W. (2015). Operative temperature drifts and occupant satisfaction with thermal environment in three office buildings using radiant heating/cooling system. *Healthy Buildings Europe 2015*.
- Koschenz, M., & Lehmann, B. (2004). Development of a thermally activated ceiling panel with PCM for application in lightweight and retrofitted buildings. *Energy and Buildings*, 36(6), 567 - 578.
- Meir, M. G., Rekestad, J. B., & Løvvik, O. M. (2002). A study of a polymer-based radiative cooling system. *Solar Energy*, 73(6), 403 - 417.
- Pavlov, G. K. (2014). *Building thermal energy storage*. Kongens Lyngby: Technical University of Denmark.