



## Effective connectivity and gamma oscillations in a group at risk of psychosis

Larsen, Kit Melissa

*Publication date:*  
2017

*Document Version*  
Publisher's PDF, also known as Version of record

[Link back to DTU Orbit](#)

*Citation (APA):*  
Larsen, K. M. (2017). *Effective connectivity and gamma oscillations in a group at risk of psychosis*. Technical University of Denmark. DTU Compute PHD-2016 No. 440

---

### General rights

Copyright and moral rights for the publications made accessible in the public portal are retained by the authors and/or other copyright owners and it is a condition of accessing publications that users recognise and abide by the legal requirements associated with these rights.

- Users may download and print one copy of any publication from the public portal for the purpose of private study or research.
- You may not further distribute the material or use it for any profit-making activity or commercial gain
- You may freely distribute the URL identifying the publication in the public portal

If you believe that this document breaches copyright please contact us providing details, and we will remove access to the work immediately and investigate your claim.

# Effective connectivity and gamma oscillations in a group at risk of psychosis

Kit Melissa Larsen

DTU



Kongens Lyngby 2017  
PhD-2017-440

Technical University of Denmark  
Department of Applied Mathematics and Computer Science  
Richard Petersens Plads, building 324, 2800 Kongens Lyngby, Denmark  
Phone +45 4525 3031, Fax +45 45882673  
[compute@compute.dtu.dk](mailto:compute@compute.dtu.dk)  
[www.compute.dtu.dk](http://www.compute.dtu.dk) PhD-2017-440

# Summary

---

22q11.2 Deletion Syndrome (22q11.2DS) has been shown to be associated with a markedly increased risk for schizophrenia. Therefore, 22q11.2DS is a homogeneous genetic liability model which enables studies intending to identify functional abnormalities that may precede disease onset of schizophrenia. Being able to define these functional abnormalities could potentially assist in the search of biomarkers for schizophrenia. These are highly desired since early notification as well as early treatment have shown positive effects on everyday functioning in schizophrenia patients.

This thesis aimed at looking for functional abnormalities, known to be found in schizophrenia, in a cohort of 22q11.2 deletion carriers. The search for functional abnormalities in the 22q11.2 deletion syndrome cohort, was carried out measuring EEG while subjects engaged in a roving mismatch negativity (MMN) paradigm as well as an auditory steady state paradigm. Both of these paradigms are known to involve processes that are impaired in schizophrenia. This thesis ties together the three main contributions which are divided into three studies.

In the first study, the responses to a roving MMN paradigm were assessed in 22q11.2 deletion carriers and healthy controls. Both conventional analysis of the MMN responses as well as a more sophisticated approach by means of Dynamic Causal Modelling (DCM) were carried out. DCM is a technique to extract effective connectivity between pre-specified brain areas. With this technique we investigated the underlying network of change detection in the two groups. While we found no indication of a reduced MMN response at the scalp level in the 22q11.2 deletion carriers, results indicated a reduced intrinsic connectivity as well as re-

duced backward connectivity in the carriers. Further, scalp data showed that 22q11.2 deletion carriers had an enhanced response to tones as increased N1 amplitudes were observed.

Second study extended study number one by employing a parametric DCM to study the underlying network of repetition suppression in 22q11.2 deletion carriers and healthy controls. Here, results indicated that repetition-dependent changes in effective connectivity can be explained by a u-shaped function, indicating that both adaptation and predictions are involved in repetition suppression. Further, scalp data showed that 22q11.2 deletion carriers had a reduced ability to suppress the responses to repeated auditory stimuli.

Finally, in the third study the ability to generate 40 Hz cortical oscillations were assessed in 22q11.2 deletion carriers as well as healthy controls using an auditory steady state paradigm. Here, it was found that both phase and power of the 40 Hz oscillatory activity were reduced in 22q11.2 deletion carriers as compared to healthy controls.

In the three studies, results both similar and dissimilar to what is observed in the schizophrenia literature were found. The studies contribute in understanding the underlying pathology of 22q11.2 deletion syndrome and if results are confirmed by longitudinal follow up studies, the results might contribute in the search of biomarkers for schizophrenia.

# Resume

---

22q11.2 Deletion Syndrom (22q11.2DS) er associeret med en markant forhøjet risiko for at udvikle skizofreni. Derfor udgør 22q11.2DS en homogen genetisk model der muliggør at undersøge funktionelle anormaliteter der finder sted før frembrud af sygdommen skizofreni. Ved at identificere disse funktionelle anormaliteter vil det potentielt være muligt at bidrage til søgen om biomarkører til skizofreni. Disse biomarkører er meget attraktive idet tidligere studier har vist at identification af skizofreni på et tidligt stadie, og dermed tidlig opstartning af behandling, kan medføre en positiv effekt på hverdagsfunktioner og funktionel status.

Formålet med denne afhandling er at søge efter funktionelle anormaliteter, som findes i skizofreni, i en gruppe med 22q11.2DS. Vi søgte efter disse funktionelle anormaliteter ved at undersøge responser til to forskellige auditive paradigmer mens vi målte EEG på bærere af 22q11.2DS og raske kontroller. De to paradigmer inkluderede et "roving mismatch negativity" (MMN) paradigme og et "auditory steady state" paradigme. Begge disse paradigmer, har vist at inkludere processer der er nedsat i skizofreni. Denne afhandling inkluderer tre forskellige studier, som sammenkædes i afhandlingen.

I det første studie blev responser til det førømtalte MMN paradigme undersøgt i bærere af 22q11.2DS samt raske kontroller. For at undersøge disse responser blev der både brugt konventionelle metoder, men også mere sofistikerede metoder som "Dynamic Causal Modelling" (DCM). DCM er en teknik til at udtrække effektiv connectivitet mellem specificerede hjerne områder. Ved hjælp fra denne teknik undersøgte vi det underliggende netværk involveret i processeringen af MMN paradigmet i begge grupper af forsøgspersoner. På trods af at vi ikke fandt nogen

forskelle i MMN responser via den konventionelle analysemetode, gav resultaterne fra DCM analysen en indikation af at nogle parametre der er involveret i processeringen af MMN paradigmet er reduceret hos bærere af 22q11.2DS. I studie nummer to udvidede vi analyserne fra studie nummer et, ved at bruge en parametrisk DCM til at undersøge det underliggende netværk for "repetition suppression". Resultaterne viste at "repetition suppression" bliver processeret i overensstemmelse med teorien "predictive coding". Derudover, indikerer resultaterne at denne process afviger en smule hos bærere af 22q11.2DS i forhold til raske kontroller. Derudover fandt vi at bærere af 22q11.2DS har en reduced evne til at undertrykke responser til gentagne stimuli. Endelig undersøgte vi i studie tre, hvorledes bærere af 22q11.2DS er i stand til at genere 40 Hz hjerne oscillationer. Både power og fase af 40 Hz hjerne oscillationer hos bærere af 22q11.2DS viste sig at være nedsat sammenlignet med raske kontroller.

I alle tre studier fandt vi både resultater der er tilsvarende det man finder i skizofreni litteraturen, men også resultater der afviger fra dette. Studierne bidrager til forståelsen af patofysiologien i 22q11.2DS. Derudover vil resultaterne kunne bruges i søgen for biomarkører til skizofreni hvis resultaterne bliver bekræftet i et longitudinelt studie.

# Preface

---

This thesis was prepared partly at the department of Applied Mathematics and Computer Science in the section, Cognitive Systems at the Technical University of Denmark and partly at Danish Research Centre for Magnetic Resonance, Centre for Functional and Diagnostic Imaging and Research, Copenhagen University Hospital (DRCMR) in fulfilment of the requirements for acquiring a PhD in engineering. The project was funded partly by a grant from the Lundbeck Foundation and by DTU Compute. During the project my main supervisor was Morten Mørup, Department of Applied Mathematics and Computer Science, Technical University of Denmark. In addition I had three co-supervisors; Professor Hartwig Roman Siebner, PhD William Frans Christiaan Barré both from DRCMR and finally professor Thomas Werge from the Mental Health Centre Sct. Hans, Capital Region of Denmark.

The thesis consists of a summary report, and a collection of 3 journal papers in total; one accepted pending minor revision (Schizophrenia Bulletin) and two in preparation. The work was carried out in the period from November 2012 to October 2016. During this period I spent 3 months visiting Dr. Marta I. Garrido at the Queensland Brain Institute, Brisbane Australia. Further I was on maternity leave in the period from summer 2015 to spring 2016.

Lyngby, 1-April-2017



Kit Melissa Larsen





# List of Publications

---

## Papers included in this thesis

- A **Larsen KM**, Mørup M, Birknow MR, Fischer E, Hulme O, Vangkilde A, Schmock H, Baaré WF, Didriksen M, Olsen L., Werge T, Siebner HR, Garrido MI. Reduced adaptation and top-down connectivity in 22q11.2 Deletion Syndrome *Manuscript in preparation*
- B **Larsen KM**, Mørup M, Garrido MI, Birknow MR, Fischer E, Olsen L, Didriksen M, Baaré WF, Werge T, Siebner HR. Reduced repetition suppression in 22q11.2 deletion syndrome. *Manuscript in preparation*
- C **Larsen KM**, Pellegrino G, Birknow MR, Kjær TN, Baaré WF, Didriksen M, Olsen L, Werge T, Mørup M\*, Siebner HR\*. 22q11.2 Deletion syndrome is associated with an impaired auditory steady-state gamma response. *Accepted for publication in Schizophrenia Bulletin pending minor revision*

## Additional papers not included in this thesis

- Schmock H, Vangkilde A, **Larsen KM**, Fischer E, Birknow MR, Jepsen JR, Olesen C, Skovby F, Plessen KJ, Mørup M, Hulme O, Baaré WF, Didriksen M, Siebner HR, Werge T, Olsen L. The Danish 22q11 research initiative. *BMC Psychiatry*. 2015 Sep 17;15:220.

- Birknow MR, **Larsen KM**, Olsen L, Werge T, Siebner HR, Mørup M, Didriksen M, Bastlund JF. Only human carriers of a 22q11.2 microdeletion have deficient auditory steady-state 40 Hz gamma response: A cross-species translational study in human and mouse. *Manuscript in preparation*
- Birknow MR, **Larsen KM**, Olsen L, Werge T, Siebner HR, Oranje B, Bastlund JF, Didriksen M. Enhanced auditory processing but normal response to mismatch in humans and mice with 22q11.2 microdeletion: A cross-species translational mismatch negativity study. *Manuscript in preparation*

# Acknowledgements

---

This thesis would not have been possible without the help and engagement from a number of people. First of all I would like to thank my four supervisors; Morten Mørup, Hartwig Siebner, William Barré and Thomas Werge.

A special thanks to my main supervisor Morten Mørup for his eager to help and never ending enthusiasm. Further, I would also like to give a special thank to Hartwig Siebner who constantly encouraged me and guided me for direction during the PhD. I would also like to thank Hartwig for including me in his group-meetings at DRCMR, I really learnt a lot from these. The input and guidance from Hartwig and Morten has been invaluable.

I would like to thank William Barré, for his help with all the logistics in connection to the project when setting up the study, collecting the data etc.. Further, I would like to thank William for giving me very constructive feedback on my written work.

A thanks to Thomas Werge for introducing me to the clinical research world and his group at mental center Sankt Hans and for being one of the initiators of the study. Further, a special thanks to Line Olsen for tying everything together and ensuing a good collaboration between all the involved institutions.

The many hours of data collection would not have been the same without the company of Trine Nørgaard Kjær, Elvira Fisher and Christian Bauer. A special thank to Michelle Rosgaard Birknow for invaluable help with the data collection.

Collection of all the clinical data would not have been possible without Anders Vangkilde and Henriette Schmock.

Marta I. Garrido should have a special thanks for letting me pursue my external research stay at her group at the Queensland Brain Institute. Marta really inspired me and helped in the process of learning the concepts of dynamic causal modelling.

Thanks to all fellow students and colleges at both Cognitive Systems at DTU Compute and at DRCMR for making a nice and encouraging working environment.

The last years would not have been the same without sharing an office with Elvira Fisher at DRCMR - Thanks for all the endless conversations, both scientifically and personally.

Thanks to my office mates at Cognitive Systems where hours and hours of chatting with Ditte Hald and Camilla Falk took place. Thank you!

A thank you to friends and family :)

Last, but not least, I would like to thank Rasmus and Asta for being there!

# Acronyms and Abbreviations

---

<b>22q11.2DS</b>	22q11.2 Deletion Syndrome
<b>A1</b>	Primary Auditory Cortex
<b>ADHD</b>	Attention Deficit Hyperactivity Disorder
<b>ASSR</b>	Auditory Steady State Response
<b>CANTAB</b>	Cambridge Neuropsychological Test Automated Battery
<b>CNV</b>	Copy Number Variant
<b>DCM</b>	Dynamic Causal Modelling
<b>DRCMR</b>	Danish Research Center for Magnetic Resonance
<b>ECD</b>	Equivalent Current Dipole
<b>EEG</b>	Electroencephalography
<b>ERP</b>	Event Related Potential
<b>EPSP</b>	Excitatory Postsynaptic Potential
<b>fMRI</b>	Functional Magnetic Resonance Imaging
<b>IFG</b>	Inferior Frontal Gyrus
<b>IPSP</b>	Inhibitory Postsynaptic Potential
<b>MINI</b>	Mini International Neuropsychiatric Interview
<b>MMN</b>	Mismatch Negativity
<b>MRI</b>	Magnetic Resonance Imaging
<b>SIPS</b>	Structured Interview for Prodromal Syndromes
<b>SOA</b>	Stimulus Onset Asynchrony
<b>STG</b>	Superior Temporal Gyrus



# Contents

---

<b>Summary</b>	<b>i</b>
<b>Resume</b>	<b>iii</b>
<b>Preface</b>	<b>v</b>
<b>List of Publications</b>	<b>vii</b>
<b>Acknowledgements</b>	<b>ix</b>
<b>Acronyms and Abbreviations</b>	<b>xi</b>
<b>1 Introduction</b>	<b>1</b>
1.1 The Danish 22q11.2 Research Initiative . . . . .	2
1.2 Objectives and Contributions . . . . .	3
1.3 Outline of the Thesis . . . . .	5
<b>2 Background</b>	<b>7</b>
2.1 22q11.2 Deletion Syndrome . . . . .	7
2.1.1 Included 22q11.2 Deletion Carriers . . . . .	8
2.2 What are we Measuring with EEG? . . . . .	9
2.2.1 Event Related Potentials . . . . .	9
2.3 The Connected Bayesian Brain . . . . .	10
<b>3 Effective Connectivity</b>	<b>13</b>
3.1 Mismatch Negativity . . . . .	13
3.1.1 Underlying Mechanisms . . . . .	15



3.1.2	MMN and Schizophrenia . . . . .	16
3.1.3	MMN and 22q11.2DS . . . . .	16
3.1.4	Predictive Coding and Schizophrenia . . . . .	17
3.2	Dynamic Causal Modelling . . . . .	17
3.2.1	Hierarchical Neural Mass Models . . . . .	18
3.2.2	Model Estimation and Bayesian Model Selection . . . . .	22
3.2.3	Inference on parameters . . . . .	25
3.2.4	Model Space . . . . .	26
3.3	Summary of Paper A and B . . . . .	26
3.3.1	Reduced adaptation and top-down connectivity in 22q11.2 Deletion Syndrome . . . . .	26
3.3.2	Reduced repetition suppression in 22q11.2 deletion syndrome	28
<b>4</b>	<b>Evoked Gamma Oscillations</b>	<b>31</b>
4.1	Auditory Steady State Responses . . . . .	31
4.1.1	Underlying Mechanisms . . . . .	32
4.1.2	ASSR and Schizophrenia . . . . .	33
4.2	Time-frequency Analysis . . . . .	34
4.2.1	Complex Morlet Wavelet . . . . .	34
4.2.2	Inter Trial Phase Coherence . . . . .	36
4.2.3	Power . . . . .	36
4.3	Summary of Paper C . . . . .	37
<b>5</b>	<b>Discussion and Conclusion</b>	<b>39</b>
<b>A</b>	<b>Reduced adaptation and top-down connectivity in 22q11.2 deletion syndrome</b>	<b>43</b>
<b>B</b>	<b>Reduced repetition suppression in 22q11.2 deletion syndrome</b>	<b>65</b>
<b>C</b>	<b>22q11.2 deletion syndrome is associated with an impaired auditory steady-state gamma response</b>	<b>87</b>
	<b>Bibliography</b>	<b>125</b>

# Introduction

---

Being able to think, feel and behave are among things we take for granted in everyday life. However, these fundamental elements are disrupted in the disease schizophrenia; a neurodevelopmental brain disorder. Schizophrenia is a severe heterogeneous disease, where diagnosis is based solely on clinical criteria (Os van et al., 2009). Schizophrenia is characterized by its symptoms; negative, positive and cognitive (Andreasen et al., 1995), and has a lifetime prevalence of 4 per 1000 live birth (Saha et al., 2005). Previous recent studies on early notification as well as early treatment of schizophrenia have shown positive effects on clinical outcomes and everyday functioning in schizophrenia patients (Larsen et al., 2010; Hegelstad et al., 2012; Melle et al., 2004). Therefore, there is a need for robust biomarkers to target not only better diagnosis but further to target new treatment.

Searching for biomarkers for schizophrenia has been occupying various scientists during the last decades, see (Weickert et al., 2013) for a review. As the diagnose of schizophrenia currently suffers from subjective decisions, the diagnosis would benefit from a more objective test. However, this imposes huge challenges due to the heterogeneity of the disease. Therefore multiple biomarkers for schizophrenia could be needed to capture subgroups of the disease. Crucial criteria for a biomarker are reliability and validity. It therefore becomes obvious that fulfilling these criteria requires many years of research as well as interdisciplinary longitu-

dinal studies.

The last decades have resulted in major breakthroughs in delineating genetic predisposition for schizophrenia. A specific genetic anomaly named 22q11.2 Deletion Syndrome (22q11.2DS) has shown to be associated with a markedly increased risk of schizophrenia (Stefansson et al., 2008; Stone et al., 2008; Bassett et al., 2008). Due to this high risk profile that 22q11.2 deletion carriers constitute, it becomes obvious to search for biomarkers within this particular group.

Event-related potentials (ERPs) measured with electroencephalography (EEG) have different properties that make them suitable in the search for potential biomarkers (Luck et al., 2011). One property is the time resolution, which makes the measure of neural synchrony, i.e. oscillations possible. Further, ERPs have been used for several decades in the investigation of psychiatric illnesses. A take-off in the search for biomarkers within the 22q11.2DS is therefore to establish if the deficits in ERP experiments observed in schizophrenia, is also present in 22q11.2DS. This motivates the topic of my thesis which exactly searches for functional abnormalities, known to be present in schizophrenia, in a group of 22q11.2 deletion carriers. The project is part of a larger Danish nation wide research initiative described extensively in (Schmook et al., 2015) and more briefly in the following section.

## 1.1 The Danish 22q11.2 Research Initiative

The Danish 22q11.2 research initiative (Schmook et al., 2015) overall aims at identifying a multi-dimensional model predictive of pathology for attention deficit hyperactivity disorder (ADHD), autism and schizophrenia. This includes different domains covering cognitive, environmental exposures, neuroanatomical and most importantly, in terms of this thesis, neurophysiological. The research initiative includes two approaches; a population based study design and a functional and structural design which in brief concerns:

**Population** This approach is based on a population containing all Danish citizens born from 1954 to present where 244 22q11.2 deletion carriers are recorded in the Danish Cytogenetic Central Register. Here, the aim is to get an overall overview of the 22q11.2 deletion carriers in Denmark in terms of incidence of developmental disorders as well as mapping environmental, family disposition and prenatal stressors to impact of disease outcomes. Additionally this approach aims to follow disease propagation over time.

**Functional-Structural** This approach is based on a recruited sample of the 22q11.2 deletion carriers where the focus is on delineating imprints of 22q11.2 by means of cognition, psychopathology, neurophysiology and neuroanatomy. This includes both a case-control setup where differences between 22q11.2 deletion carriers and healthy non-carriers can be investigated as well as a case-only design where correlates of the imprints can be studied. This design includes two protocols; one protocol including psychopathology and cognition and a protocol including functional brain mapping.

The current thesis focuses on the functional-structural approach of the research initiative with a main emphasis on the functional brain mapping protocol. The content on this approach and what is a part of the current thesis, is summarised in figure 1.1. In particular the main focus in this thesis is the EEG part of the project, where I have collected and analysed data from the two auditory paradigms; a roving mismatch negativity (MMN simple in figure 1.1) paradigm and an auditory steady state paradigm (ASSR in figure 1.1).

In order to investigate how the EEG signatures correlate with the individual psychopathology of the 22q11.2 deletion carriers the symptoms scores (from SIPS in figure 1.1), were included as well. These were collected by two experienced and SIPS certified clinicians.

## 1.2 Objectives and Contributions

The main objective of this thesis was to examine electrophysiological abnormalities, consistently found in schizophrenia, in a group of 22q11.2 deletion carriers and healthy non carriers. To this end, high density EEG was used while subjects engaged in two different auditory paradigms; MMN and ASSR. Both of these paradigms involve underlying processes that are impaired in schizophrenia. The work is divided into three different studies where the objective for each can be seen below:

**Study 1:** An auditory MMN paradigm was used to test for differences in MMN responses as well as investigate effective connectivity in the underlying neural network model of change detection in the 22q11.2 deletion carriers as compared to healthy non carriers.

**Study 2:** In the same auditory paradigm from study 1 we studied the underlying

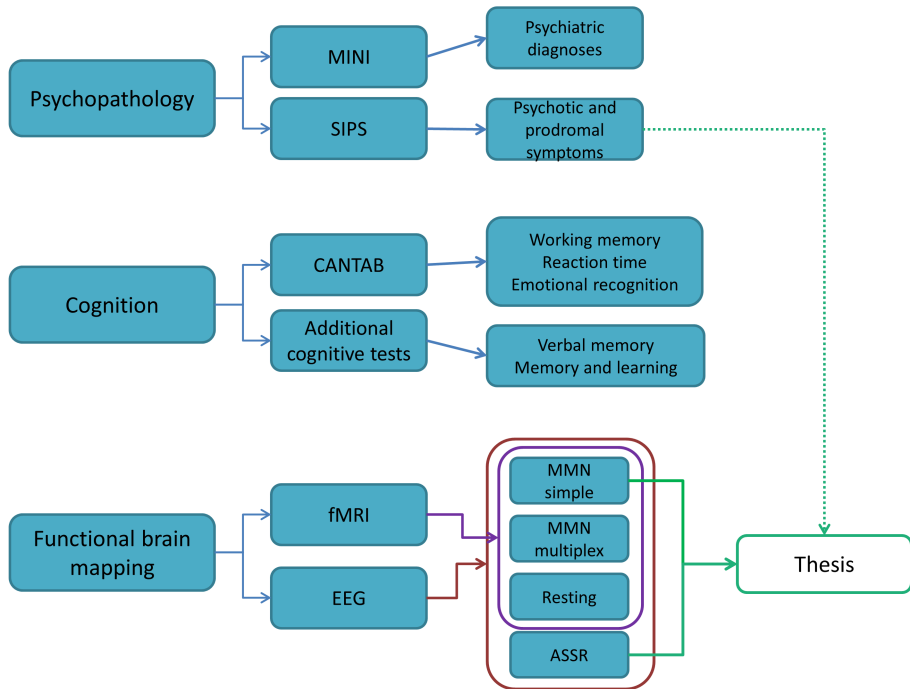

**Figure 1.1:** Overview of the functional-structural approach of the Danish 22q11.2 Research Initiative divided into the three parts; psychopathology, cognition and functional brain mapping. As can be seen from the figure, the MMN simple and ASSR from the EEG package is part of the current thesis. The dotted line connecting results from the SIPS scores, represents that the data from the SIPS scores are included in the thesis but not the main part.

neural network of repetition suppression in 22q11.2 deletion carriers and healthy non carriers.

**Study 3:** An ASSR paradigm was used to study how gamma oscillations and thereby cortical integration of information is affected in 22q11.2 deletion carriers as compared to healthy non carriers.

## 1.3 Outline of the Thesis

In addition to the current chapter, the thesis consists of chapters that tie together contributions from the papers which include one submitted journal paper (accepted for publication in Schizophrenia Bulletin pending minor revision) as well as two journal paper drafts. In summary, the remainder of the thesis is structured as follows:

**Chapter 2** Gives the background information common for the work conducted in the thesis.

**Chapter 3** Describes the background and methods used in study 1 and 2 regarding effective connectivity in 22q11.2 deletion carriers. Further, the chapter includes a summary of findings in the two studies.

**Chapter 4** Describes the background and methods used in study 3 where neural processing in cortical circuits via auditory steady state potentials in 22q11.2 deletion carriers were investigated. A summary of findings in study 3 is also included in this chapter.

**Chapter 5** This chapter discusses the findings of the three contributions altogether and gives perspectives of future work.



# Background

---

With this chapter, the reader is provided with background information common for the three contributions of the thesis. Starting with section 2.1, the 22q11.2 Deletion Syndrome is described. Hereafter, section 2.2 will introduce what we are measuring with EEG and what it can be used for. Section 2.3 will end the chapter by describing how the brain can be seen as a connected Bayesian device.

## 2.1 22q11.2 Deletion Syndrome

The 22q11.2 deletion syndrome (22q11.2DS) is one of the most common copy number variants (CNV) caused by a microdeletion on the long arm of chromosome 22 (Goodship et al., 1998; Oskarsdóttir et al., 2004; Robert J. Shprintzen, 2005) with the majority of the deletions being 3 megabases in size. The clinical phenotype of the syndrome is highly variable ranging from congenital heart disease, abnormalities of the palate to learning problems and psychiatric problems (Robin, Shprintzen, 2005). Recently it has become clear that individuals carrying a 22q11.2 deletion have an increased risk of developing neurodevelopmental disorders such as schizophrenia, autism spectrum disorder and attention deficit



hyperactivity disorder (Bassett et al., 2008; Schneider et al., 2014; Purcell et al., 2009). In a recent Danish registry study (as part of the Danish 22q11.2 Research Initiative) the risk of developing schizophrenia was approximately 8 times higher than in the normal population (Vangkilde et al., 2016). According to the International Consortium on Brain and Behavior in 22q11.2 Deletion Syndrome, the prevalence of schizophrenia-spectrum disorder is 24% in adolescent and 41% in adult 22q11.2 deletion carriers (Schneider et al., 2014). This high prevalence of schizophrenia development in 22q11.2 deletion carriers, makes the 22q11.2 deletion the highest known genetic risk factor for schizophrenia and therefore a good model for studying early pathogenesis of schizophrenia. Investigation of the early pathogenesis of schizophrenia can potentially lead to early clinical diagnostics and therefore intervention. This is highly relevant from a clinical perspective since early detection of schizophrenia and hence early intervention has shown positive effects on clinical as well as functional status (Larsen et al., 2010; Hegelstad et al., 2012).

### 2.1.1 Included 22q11.2 Deletion Carriers

All 22q11.2 deletion carriers included in the studies as part of the current thesis are a subgroup of the Danish 22q11.2 cohort described in the introductory chapter and extensively in (Schmook et al., 2015). All deletion carriers were without a diagnosis of schizophrenia or any other psychotic illnesses. Further, a control group without the deletion were included with comparable age distribution and sex ratio. The exclusion criteria for the control group were as follows:

- Schizophrenia, schizotypal and delusional disorders (ICD10 DF20-29)
- Bipolar disorder (ICD10 DF30-31)
- Depression (ICD DF32-33) except for a past episode of mild or moderate depression (ICD10 DF 32.0 or 32.1)
- Substance abuse
- A first degree relative with a psychotic illness

Both 22q11.2 deletions carriers as well as non carriers were in the age range from 12 to 25 years. The age limit of 12 were chosen in order to ensure that the children were able to cope with the entire examination. Since schizophrenia usually takes its onset in early adulthood, the age of 25 were chosen as the higher age limit.

## 2.2 What are we Measuring with EEG?

EEG is a widespread method for recording electrical signals from the brain by attaching electrodes to the scalp of the head. By accessing these signals it is possible to get an insight into how the brain works in different scenarios both in normal circumstances but also under pathological states on a very high temporal resolution. The signals measured with EEG, originate from communication between neurons in the cortex (Niedermeyer, Da Silva, 2004; Nunez, Srinivasan, 2006). Each neuron consists of a cell body that branches into dendrites and an axon. The axon serves as a contact to either other neurons or target organs whereas the dendrites act as the input source to the neuron receiving the transmitted signal and generate small currents that propagate to the cell body. The communication between the neurons can either be excitatory or inhibitory via excitatory/inhibitory postsynaptic potentials (E/IPSP). The EPSP makes an action potential more likely whereas the IPSP acts in the opposite direction and inhibit an action potential (Nunez, Srinivasan, 2006). The change in the membrane potential of the neuron gives rise to a current flow which again gives rise to a field potential in the extracellular space. When the neurons are aligned this field potential sums up and can be recorded via the electrodes on the scalp. Since the pyramidal cells located in the cortex are aligned, the measured EEG signals are believed to be generated from these (Nunez, Srinivasan, 2006).

One of the main challenges when using EEG, is the low spatial resolution. However, the high temporal resolution that EEG offers makes it possible to, amongst other things, closely study the processes aligned to a certain event or stimuli, the event related potential (ERP) (Luck, 2014).

### 2.2.1 Event Related Potentials

Event related potentials (ERPs) are the brain potentials observed time locked to a given external event. The signal recorded is usually very small compared to the background EEG, and to overcome this, multiple events of the same condition is usually averaged together to obtain a higher signal to noise ratio (Luck, 2014). The ERPs can be used to assess different processes, for example sensory information processing within different domains. In the current thesis ERPs were used to assess sensory information in the auditory domain. Using auditory evoked potentials, the components spanning the full length of the auditory pathway can be studied (Pratt, 2011). The very early components recorded in the initial 10 ms after stimulus onset include the auditory nerve and brainstem responses (ABRs). The middle latency responses are defined between 10 and 60 ms after stimulus

onset and finally the long latency components defined between 60 and 200 ms after sound onset. The components of the long-latency responses is usually defined by their polarity and latency. The general components of an auditory evoked potential is, P50, N1 and P2, occurring around 50ms, 100ms and 200 ms after stimulus onset respectively. The P and N refers to the polarity of the components and stands for positive or negative respectively.

Both the middle latency and long latency potentials are believed to reflect cognitive processing of the sensory input (Pratt, 2011).

## 2.3 The Connected Bayesian Brain

The cerebral cortex is organised in a hierarchical manner consisting of 6 layers with 10 to 14 billion neurons (Felleman, Van Essen, 1991; Shipp, 2007). Layer I is the molecular layer, which contains very few neurons; layer II the external granular layer; layer III the external pyramidal layer; layer IV the internal granular layer; layer V the internal pyramidal layer; and layer VI the multiform, or fusiform layer. Each cortical layer contains different neuronal shapes, sizes and densities as well as different organizations of nerve fibres. Functionally these six layers of the cortex can be divided into three layers. Layers I-III make up the supragranular layer, where layers V and VI constitutes the infragranular layer. Together these two layers are called agranular layers. Layer IV constituting the granular layer. The reason for this structuring is the way the different layers communicate within the cortical sheet (via intrinsic connections) but also to other regions (via extrinsic connections) as defined by (Felleman, Van Essen, 1991). Lateral connections originate in the agranular layers and target all layers. The forward connections originates in the agranular layers as well and terminate in the granular layer. Finally backward connections originates in the agranular layers and target agranular layers.

The connections forward and backward, mediate two types of processing; bottom-up and top-down processing respectively. Bottom-up (also called forward) processing includes information passing from lower level areas to higher level areas whereas top-down (also called backward) processing concerns information passing from higher level areas to lower level areas. Within this notion, lower level areas are associated with processing of sensory input whereas the higher level areas represents more cognitive associative areas (Mumford, 1992). The way that this information passing is taking place, is then in accordance to the connectivity rules described above.

Predictive coding (Rao, Ballard, 1999; Friston, 2002b, 2005) is the notion that the brain makes inferences about the causes of sensory input and constantly tries

to minimize prediction errors. This idea goes in line with the notion that the brain is working as a Bayesian device as postulated in *The Bayesian brain hypothesis* (Knill, Pouget, 2004). The Bayesian brain hypothesis implies that the brain utilises Bayesian probability theories in order to infer on causes. Hence, the brain is building a model of the "world" and then uses this model to predict future events. According to Bayesian probability theories, the brain formulates a prior expectation of the causes (i.e. prior probability  $p(\theta)$ ) in higher levels. The likelihood of the data, given the causes  $p(y|\theta)$  is generated in the lower levels that can then be used to compute the posterior probabilities of the causes  $p(\theta|y)$ . That means that the brain is believed to act in accordance with Bayes rule given in (2.1).

$$p(\theta|y) = \frac{p(y|\theta)p(\theta)}{p(y)} \quad (2.1)$$



# Effective Connectivity

---

This chapter presents background information as well as methods for study 1 and 2 which focus on the underlying neural network as well as effective connectivity engaged in a roving MMN paradigm. In the first section, section 3.1, the reader will be provided with an introduction to the auditory paradigm used. In order to investigate effective connectivity in the 22q11.2 deletion carriers, we utilised Dynamic Causal Modelling (DCM), which is described in section 3.2. Finally the chapter is rounded off by a summary of findings in the two contributions; paper A and paper B.

## 3.1 Mismatch Negativity

Mismatch negativity is evoked in oddball paradigms whereby standard stimuli form a rule that is occasionally violated by oddball events. The auditory MMN was first discovered by Risto Näätänen back in 1978 (Näätänen et al., 1978) and has since become a widely used tool in cognitive neuroscience (Näätänen, Winkler, 1999; Näätänen et al., 2007) as well as in clinical research (Näätänen, 2003). Classical oddball paradigms include a sequence of sounds where standard tones

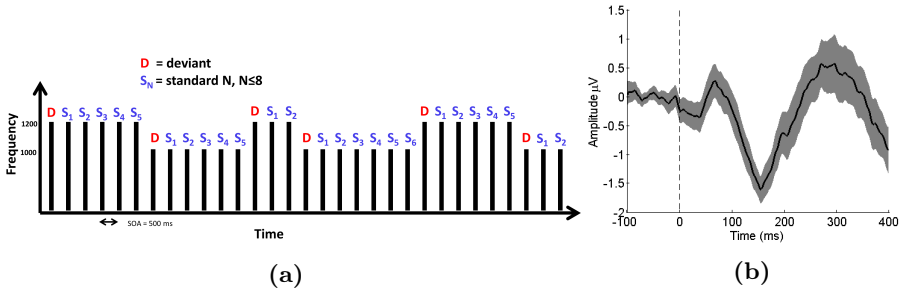

**Figure 3.1:** (a) Experimental design of the roving MMN paradigm. (b) MMN response from channel Fz, when subtracting S4 (tone number 5) from D (tone number 1).

are presented the majority of the time, for example 80% and oddball events are then introduced to violate a rule appearing randomly with a 20% probability in this example. The MMN can then be extracted by subtracting the response to the standard tone from the response to the oddball tone. MMN has a negative deflection peaking at 100-250 ms after onset of the change. Oddballs in MMN paradigms can break different types of regularities; frequency, duration, silent gap or intensity and different kind of oddballs can further be combined into one paradigm (Näätänen et al., 2004).

MMN is not only elicited in classical settings but also in roving paradigms (Baldeweg et al., 2004; Garrido et al., 2008), where the nature of the memory trace leading to MMN can be investigated. The MMN paradigm used in the work of this thesis is a roving MMN paradigm adapted from (Garrido et al., 2008), see figure 3.1a. Within each stimulus train or sequence, all tones are of one frequency, either 1000 Hz or 1200 Hz respectively and followed by a train with changed frequency. The number of tones in each sequence is drawn from a uniform distribution between 1 and 9. Within this setup, the first tone of each sequence deviates from the preceding tone, and is perceived as an oddball that with number of repetitions becomes the new standard. One of the advantages of using a roving MMN paradigm as compared to classical oddball paradigms is that the responses extracted to generate the MMN stems from the same stimuli, i.e. having the same physical property. Hence, any difference in the two responses can only be explained by its perception and not the stimuli per se. An example of a MMN response from the roving paradigm employed in the current thesis extracted from channel Fz, can be seen in figure 3.1b. The response shows a negative deflection around 150 ms, which characterises the MMN.

From the roving paradigm the phenomenon of repetition suppression can also be

studied. Repetitions of tones result in a decrease in evoked responses i.e. repetition suppression. This mediates changes in mismatch responses as repetitions of tones increases and the oddball eventually becomes the standard.

### 3.1.1 Underlying Mechanisms

MMN is believed to reflect an index of change-detection (Näätänen, 1995; Friston, Stephan, 2005; Näätänen et al., 2007). Hence the MMN mirrors the brain's ability to perform automatic comparisons between consecutive stimuli and by means of EEG it provides an electrophysiological index of sensory learning and perceptual accuracy. Although the MMN has been studied extensively, the underlying mechanisms are not fully understood yet. However it is now becoming more and more evident that MMN has been reframed in terms of an interplay between current inputs and predictions based on a learnt regularity (Garrido et al., 2009), accommodated by the theory of predictive coding (Rao, Ballard, 1999; Friston, 2003, 2005). In this way predictive coding has unified two competing hypotheses about the MMN; the model-adjustment hypothesis and the adaptation hypothesis. The model-adjustment hypothesis states that MMN is a response to an unexpected stimulus change, hence an error detection mechanism where incoming stimuli are compared to the memory trace of past events (Näätänen, Winkler, 1999; Sussman, Winkler, 2001; Winkler et al., 1996). The adaptation hypothesis implies that MMN is generated by much simpler mechanisms, namely neural adaptation of neurons in the auditory cortex (Jääskeläinen et al., 2004). This neural adaptation causes a delayed N1 component as well as a decrease in amplitude. The N1 component is related to early auditory processing and is the negative component observed 80-120 ms after stimulus onset (Näätänen, Picton, 1987). Hence when obtaining the difference wave, the adaptation hypothesis states that the MMN is a product of the N1 differential.

Neural generators of the MMN have been widely studied, see for example (Doeller et al., 2003; Grau et al., 2007; Opitz et al., 2002; Rinne et al., 2000). The proposed underlying sources include bilateral primary auditory cortex (A1), bilateral superior temporal cortex where the secondary auditory cortex is located (STG), and finally bilateral inferior frontal gyrus (IFG) although findings are most consistent in the right hemisphere for the IFG.

Approaches to modelling MMN have shown evidence that predictive coding can account for the MMN (Garrido et al., 2007, 2009; Wacongne et al., 2012). The predictive coding theory postulates an interplay between current inputs and predictions based on a learnt regularity, involving bottom-up and top-down processing linking lower-level sensory systems with higher order cortical areas (Friston, 2003). Prediction errors are passed via forward connections up the hierarchical



level where predictions then are passed down the hierarchy via backward connections.

### 3.1.2 MMN and Schizophrenia

It is well established that MMN is reduced in schizophrenia (Catts et al., 1995; Michie, 2001; Näätänen, Kähkönen, 2009; Umbricht, Krljesb, 2005). In addition to this it has become evident that MMN is also reduced in first-episode psychosis (Atkinson et al., 2012; Hsieh et al., 2012) as well as first degree relatives (Jessen et al., 2001; Michie et al., 2002). The MMN is usually observed reduced at frontal sides, but intact at temporal sides in schizophrenia (Baldeweg et al., 2002). A recent study aiming for prediction of psychosis using duration MMN, demonstrated that the MMN was significantly reduced in at-risk subjects who converted to first-episode psychosis when comparing to non-converters (Bodatsch et al., 2011). The authors argue that MMN can be used as a predictor for conversion and an individualised risk estimation.

### 3.1.3 MMN and 22q11.2DS

Studies on MMN in 22q11.2DS are limited. Although, the first study was conducted in 1997 by (Cheour et al., 1997), where a reduced MMN to pitch deviants was observed in children with CATCH (previous name of 22q11.2DS) compared to healthy children, the follow up studies are few. Since then, it was found by (Baker et al., 2005) that duration MMN was reduced at frontal sides but preserved at temporal sides. This is in line with what is observed in the schizophrenia literature (see section 3.1.2 above). However, a more recent study by (Zarchi et al., 2013) did not replicate these findings and showed no difference in MMN amplitudes between carriers of 22q11.2 deletion syndrome and healthy controls when using frequency, intensity, directionality, duration and silent gap deviants. However, there are some differences between the two studies; in (Baker et al., 2005) subjects included were 12-21 years of age and no subjects met criteria for a diagnosis of psychotic disorder. In (Zarchi et al., 2013) the age of subjects had a mean of 20.6 years with standard deviation 9.6 and a proportion (14.65%) met criteria for schizophrenia. These dissimilarities between studies might contribute in explaining the differences in results.

### 3.1.4 Predictive Coding and Schizophrenia

Recent studies have shown that the interplay between top-down and bottom-up processing involved in predictive coding, is disrupted in schizophrenia (Fogelson et al., 2014; Dima et al., 2010, 2012; Adams et al., 2013). In (Dima et al., 2010) DCM was used to assess effective connectivity when subjects engaged in a hollow mask illusion task. The authors showed a weakened top-down processing together with a strengthened bottom-up processing in schizophrenia patients as compared to controls. In (Fogelson et al., 2014), elevated connectivity within the visual system during target detection, from higher hierarchical levels to lower levels was observed. In addition to this, (Adams et al., 2013) suggest that parts of the pathology of schizophrenia can be explained by a loss of precise top-down predictions, suggesting that everything is perceived as surprising.

Traditional approaches to analysing MMN responses involve extracting amplitude and latency values from pre-selected electrodes and pre defined time windows. However, it is believed that functional integration among brain areas is a core pathology of psychosis as formulated in the disconnection hypothesis (Friston, 1998; Stephan et al., 2006) and therefore encourage the use of more sophisticated ways of analysing MMN responses. This motivates the use of DCM, a hypothesis driven method to extract effective connectivity among pre-specified brain areas, explained in the following section.

## 3.2 Dynamic Causal Modelling

Dynamic causal modelling (DCM) is a hypothesis driven biologically plausible method to estimate effective connectivity between known sources or brain areas and how this is affected by experimental factors (David et al., 2006; Friston et al., 2003). Effective connectivity is the influence of one neural system exerts over another (Friston, 2011). The method was originally developed for fMRI (Friston et al., 2003) modelling the hemodynamic response but later the huge potential for applying it to EEG data became clear because of the high temporal resolution that EEG offers. Within the EEG modality, DCM can be employed for ERP's, induced responses, cross spectral densities and phase coupled responses. Here only DCM for ERPs will be described since it was used for ERPs in this thesis.

### 3.2.1 Hierarchical Neural Mass Models

DCM is build upon neural mass models of interacting cortical regions. A forward model then supplements the neural mass models of neural activity, transforming the neural activity into the measured EEG scalp data (here ERPs). The neural mass models are based on the model by (Jansen, Rit, 1995) and described extensively in (David et al., 2005). The models take into account the hierarchical organisation of the cortex wherein three subpopulations of neurons (pyramidal, spiny-stellate and inhibitory interneurons) are assigned to the three layers of the cortex. In the agranular layers the excitatory pyramidal cells and inhibitory interneurons are located whereas the excitatory spiny stellate cells are located in the granular layer. These three subpopulations of neurons and thereby cortical layers are connected with intrinsic connections.

Together, the three layers in a certain area make up a one source model that then can be used to construct a hierarchical network of sources that communicate via extrinsic connections. Within the hierarchical network of sources forward connections originate in the agranular layers and terminate in the granular layer, backward connections link agranular layers and finally lateral connections originate in agranular layers and target all layers. These connectivity rules are described in (David et al., 2005) and based on (Felleman, Van Essen, 1991). The concept of a single source DCM can be seen in figure 3.2a together with a four source DCM in figure 3.2b, where each cortical layer is represented in the rectangular boxes. From each of the cortical layers the state equations that are assigned to the subpopulations can be seen. Each equation is a first-order differential equation describing the rate of voltage change in the neural population, see equation (3.1).

$$\begin{aligned}
 \dot{x}_7 &= x_8 \\
 \dot{x}_8 &= \frac{H_e}{\tau_e}((A^B + A^L + \gamma_3 I)S(x_0)) - \frac{2x_8}{\tau_e} - \frac{x_7}{\tau_e^2} \\
 \dot{x}_1 &= x_4 \\
 \dot{x}_4 &= \frac{H_e}{\tau_e}((A^F + A^L + \gamma_1 I)S(x_0) + Cu) - \frac{2x_4}{\tau_e} - \frac{x_1}{\tau_e^2} \\
 \dot{x}_0 &= x_5 - x_6 \\
 \dot{x}_2 &= x_5 \\
 \dot{x}_5 &= \frac{H_e}{\tau_e}((A^B + A^L)S(x_0) + \gamma_2 S(x_1)) - \frac{2x_5}{\tau_e} - \frac{x_2}{\tau_e^2} \\
 \dot{x}_3 &= x_6 \\
 \dot{x}_6 &= \frac{H_i}{\tau_i}\gamma_4 S(x_7) - \frac{2x_6}{\tau_i} - \frac{x_3}{\tau_i^2}
 \end{aligned} \tag{3.1}$$

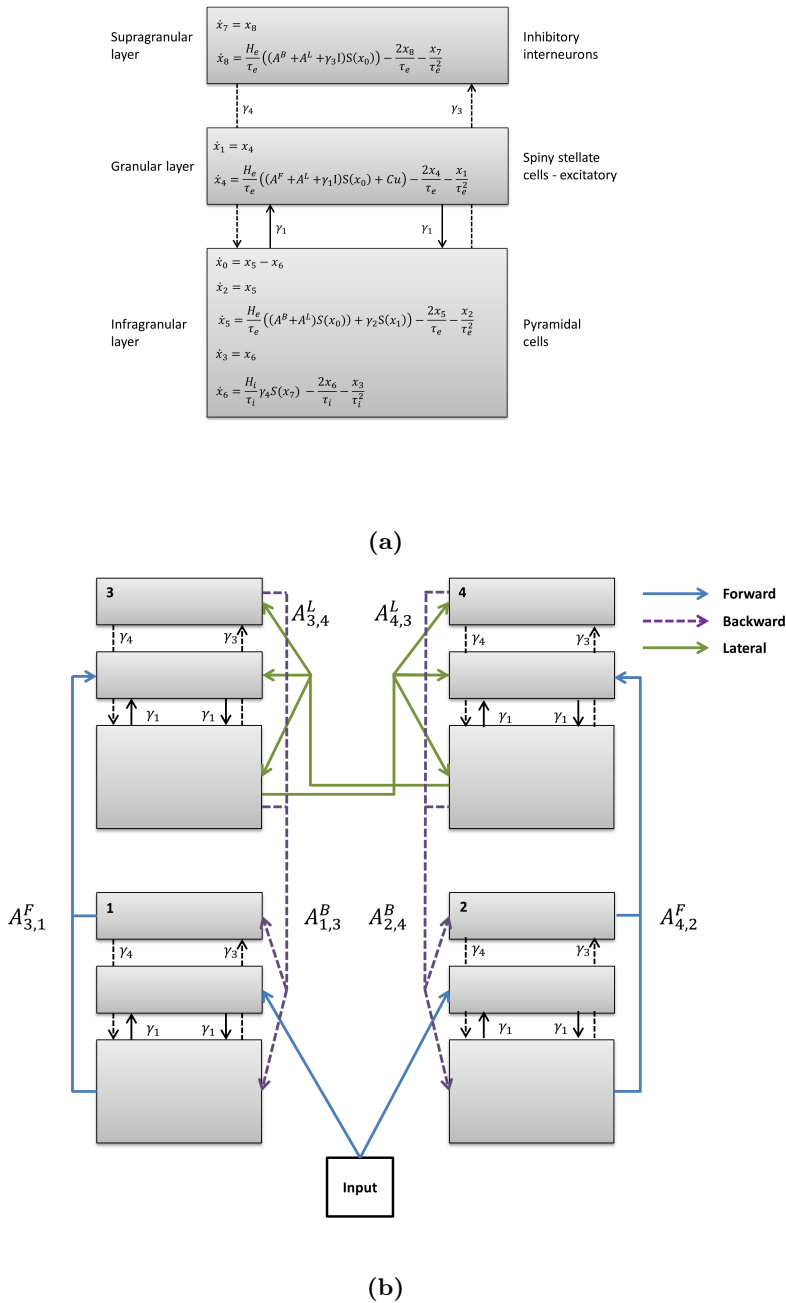

**Figure 3.2:** (a) One source DCM with the neural mass models assigned to each sub-population (b) 4 source DCM, and the connectivity rules for the extrinsic as well as intrinsic connections. Figure inspired from (David et al., 2006; Kiebel et al., 2008)

Within a given source, the states  $x_0, \dots, x_8$ , represents the mean transmembrane potentials. In equation (3.1) and in figure 3.2a the matrices  $A^F, A^B, A^L$  contains the extrinsic forward, backward and lateral connections respectively,  $Cu$  contains the input connections.  $\gamma_{1,2,3,4}$ , controls the strength of intrinsic connections between the three subpopulations and reflect the total number of synapses in each sub-population. The parameters  $H_{e,i}$  and  $\tau_{e,i}$  represents the maximum post-synaptic potential and the time rate constants for the synapses with the subscripts  $e, i$  referring to either excitatory or inhibitory. The average depolarisation of pyramidal cells in each source,  $x_0$  includes potentials induced by both excitatory and inhibitory currents. Within the framework of this model, the potential  $x_0$ , is presumed to be the source of the observed EEG signal.

The final elements for describing the neuronal model underlying DCM are two operations that describe the dynamics of the synaptic potentials. The first translates the average of pre-synaptic input  $p$ , into the average post synaptic potentials  $x$  by convolving with the kernel  $h$ ,  $x = h * p$  where  $h$  is defined in (3.2). Finally, the last operator  $S$ , transforms the average membrane potential of the subpopulations,  $x$ , into an average firing rate, see equation (3.3) where  $r$  is a parameter controlling its curvature.

$$h(t) = \begin{cases} \frac{Ht \exp(-t/\tau)}{\tau} & t \geq 0 \\ 0 & t < 0 \end{cases} \quad (3.2)$$

$$S(x) = \frac{1}{1 + \exp(-rx)} - \frac{1}{2} \quad (3.3)$$

From figure 3.2 and the state equations in 3.1, it can be seen that the connectivity rules described earlier are obeyed. As an example  $\dot{x}_8, \dot{x}_4$  and  $\dot{x}_5$  obeys that the state dynamics are mediated by lateral connectivity in all three layers whereas the state dynamics are mediated by forward and lateral connection in the granular layer (see  $\dot{x}_4$ ) and backward and lateral connections in the agranular layer (see  $\dot{x}_5$ ).

In order to model perturbations caused by an event or stimulus, an input,  $u$ , is needed. As mentioned, this is fed to the system via the input connections contained in  $Cu$ , that is equivalent to forward connections with input delivered to the granular layer. The input is modelling the afferent activity from subcortical sources and given by equation (3.4), (David et al., 2006).

$$u(t) = b(t, \eta_1, \eta_2) \quad (3.4)$$

Equation (3.4) models the event-related burst, delayed with respect to stimulus onset and the dispersion of subcortical synapses and conduction, given by a gamma density function with scale constants  $\eta_1$  and  $\eta_2$  (David et al., 2006). An

important thing to note is that the event related input is the same for all stimuli, meaning that any effect of the experimental factors is caused by ERP-specific changes in connection strengths.

The difference in responses due to experimental stimuli can be mediated either by extrinsic connections or intrinsic connections (David et al., 2006). The extrinsic reflects the changes in coupling to other sources, whereas the intrinsic reflects changes within one source: i.e. mediating local adaptation. The effect of stimuli on the extrinsic connections is modelled by coupling gains as seen in (3.5).

$$\begin{aligned} A_{i,j,k}^F &= A_{i,j}^F B_{i,j,k} \\ A_{i,j,k}^B &= A_{i,j}^B B_{i,j,k} \\ A_{i,j,k}^L &= A_{i,j}^L B_{i,j,k} \end{aligned} \tag{3.5}$$

In (3.5),  $A_{i,j}$  includes the strength of connection from the  $j$ 'th to the  $i$ 'th source and  $B_{i,j,k}$  is the the gain for the  $k$ 'th ERP. As in figure 3.2a,  $F, B, L$  in (3.5) represents forward, backward and lateral connections. The intrinsic connections is modelled by a gain on the amplitude of  $H_e$ , where a gain greater than one means that the maximum response that can be observed from a given source is increased.

In brief, DCM is defined by its state equations given in (3.1) and summarised on compact form in (3.6) as well as an output function,  $y$ , given by (3.7).

$$\dot{x} = f(x, u, \theta) \tag{3.6}$$

$$y = L(\psi)x_0 + \epsilon \tag{3.7}$$

The spatial forward model linking the signal of the pyramidal subpopulation  $x_0$  to the scalp data  $y$ , given by the lead field matrix  $L(\psi)$  in (3.7) is parametrized by the location and orientation of each source (Kiebel et al., 2006). This matrix gives the contribution of each source to the scalp level ERP data, hence the equation provides the relationship between the neuronal states and the measured ERP data. In the work of the current thesis it is assumed that the spatial expression of each source is modelled by one equivalent current dipole (ECD). The head model employed assumes that the brain, scalp, skull and cerebrospinal fluid can be approximated by 4 concentric spheres. Each sphere has a homogeneous and isotropic conductivity. The leadfield for each dipole becomes a function of orientations as well as locations of the dipoles.

In summary, by integrating the state equations and passing the states through the observer equation, the predicted measurement can be generated.

### 3.2.2 Model Estimation and Bayesian Model Selection

Each model is fitted to the EEG data by choosing the parameters of the model,  $\theta$ , that minimises the difference between the observed and predicted EEG data when accounting for the model complexity (Kiebel et al., 2008; David et al., 2006). The parameters of DCM can be divided into six categories; 1) extrinsic coupling parameters, 2) intrinsic coupling parameters, 3) conduction delays, 4) synaptic parameters, 5) input parameters and 6) intrinsic and extrinsic coupling gain parameters (David et al., 2006). The intrinsic coupling parameters as well as conduction delay are fixed parameters. The rest of the parameters are estimated in the estimation procedure. This of course implies that prior assumptions about the parameters are made. A table of the prior for the parameters can be seen in (David et al., 2006).

The estimation procedure of the DCM is described extensively in (Friston, 2002a; Friston et al., 2003) and more briefly in the following.

For a given DCM model,  $m$ , it is desired to approximate the posterior distribution which is given by Bayes rule in equation (3.8), where  $p(y|\theta, m)$  is the likelihood of observing the data conditioned on the parameters  $\theta$  of a given model  $m$ .  $p(\theta|m)$  is the prior probability of the parameters  $\theta$ .

$$p(\theta|y, m) = \frac{p(y|\theta, m)p(\theta, m)}{p(y|m)} \quad (3.8)$$

Since it is assumed that the posterior distribution is Gaussian, the estimation includes estimating the mean  $\mu$  and the covariance  $\Sigma$ . Estimating  $\mu$  and  $\Sigma$  is carried out iteratively using a Variational Bayes scheme under a fixed-form Laplace approximation to the posterior density of the parameters  $q(\theta) = N(\mu, \Sigma)$  (Friston et al., 2007). This involves maximizing the variational free energy via an expectation-maximization algorithm (EM) with respect to the conditional moments (mean  $\mu$  and the covariance  $\Sigma$ ) of the free parameters  $\theta$ . The free energy  $F(q, \lambda, m)$ , with  $\lambda$  being the error variance is minimized in the **E**-step with respect to the conditional moments ( $q$ ). Hereafter the **M**-step is performed that minimises the free energy, now with respect to the error variance  $\lambda$ . Below in equation (3.9) the two steps can be seen which is carried out until convergence of the algorithm.

$$\begin{aligned} \mathbf{E} - \text{step } q &\leftarrow \min_q F(q, \lambda, m) \\ \mathbf{M} - \text{step } \lambda &\leftarrow \min_\lambda F(q, \lambda, m) \\ F(q, \lambda, m) &= \langle \ln q(\theta) - \ln p(y|\theta, \lambda, m) - \ln p(\theta|m) \rangle_q \end{aligned} \quad (3.9)$$

In short, the parameters are updated in the E-step and the error term is updated in the M-step. As can be seen from (3.9), the free energy  $F(q, \lambda, m)$  is a function

of the log likelihood, the log prior and the conditional density  $q(\theta)$ . The free energy is equal to the Kullback-Leibler divergence, between the approximated and true conditional density, minus the log-likelihood. This means that by minimizing the free energy the log-likelihood is maximised and the difference between the true and approximated conditional density is minimized.

When models have been estimated, the next step is to compare different models in order to test a specific hypothesis. The comparison between models uses the model evidence as given in (3.10), where a higher model evidence is desirable. As can be seen from (3.10), the model evidence includes integrating out model parameters. As this is not straightforward to do, the model evidence is approximated by Variational approximation.

$$p(y|m) = \int p(y|\theta, m)p(\theta|m)d\theta \quad (3.10)$$

When comparing models there are two approaches; fixed effect analysis and random effects analysis which are described in the following.

### 3.2.2.1 Fixed Effects Analysis

Dealing with neuroimaging data usually includes data from multiple subjects. The DCM models are fitted to each of these subjects, hence for each  $n = 1, \dots, N$  subjects,  $m = 1, \dots, M$  models are fitted. When comparing models using fixed effects analysis (FFX), it is assumed that each subject uses the same model (Stephan et al., 2009; Penny et al., 2010). This is the same as assuming the model structure is identical across subjects or simply that each subject is using the same strategy for processing the stimuli. If  $Y$  is comprised of data for each subject  $y_n$ , the overall model evidence is given by equation (3.11). Assuming uniform prior on the models (i.e. each model is equally likely), the comparison between models  $m = i$  and  $m = j$  can then be carried out using the ratio between model evidences, known as Bayes factor, see (3.12).

$$\ln p(Y|m) = \sum_{n=1}^N \ln p(y_n|m) \quad (3.11)$$

$$BF_{ij} = \frac{p(Y|m = i)}{p(Y|m = j)} \quad (3.12)$$



### 3.2.2.2 Random Effects Analysis

A different strategy for comparing models is random effect analysis (RFX) (Stephan et al., 2009; Penny et al., 2010). Here, as opposed to the FFX, the assumption is that subjects do not necessarily use the same network to process the stimuli. This can be useful when you do not expect subjects to engage the same models, for example in clinical populations where a cognitive task might be solved using different strategies. Further, RFX is not as sensitive to outliers as FFX is. Put in short, the potential heterogeneity across a group is taken into account when performing RFX group level inference on model space. With RFX not only the model evidence is taken into account, but also the frequency  $r_m$  at which model  $m$  is used in the population. Hence  $r_m$  can be perceived as the model probability. By adding a prior distribution over the model frequency  $r_m$ , treating the model as a random variable, a Dirichlet distribution is used to describe the probabilities for all models considered. For a randomly chosen subject, a multinomial distribution over the models space then allows to compute how likely it is that a particular model generated data from the drawn subject.

When comparing the models against each other, exceedance probabilities can be used. The exceedance probability is the probability of one model being more likely than any other model. The exceedance probability can be computed from the conditional model probability (Stephan et al., 2009), see (3.13), where  $\alpha$  is the parameter for the Dirichlet distribution and  $K$  are the models tested.

$$\psi_k = p(r_k > r_j | y, \alpha) \quad (3.13)$$

The exceedance probabilities observed from (3.13) sum to one over the models tested.

### 3.2.2.3 Family Inference

If the hypothesis of interest does not cover one particular parameter of the model but is more focused on the structure of the model space, inference can be made at the level of model families instead of the individual models themselves (Penny et al., 2010). An example of a hypothesis where it becomes obvious to do family level inference is: *Is the responses modulated by changes in forward connections or both forward and backward connections?* Here the models can be divided into two families; models with only forward connections and models with both forward and backward connections. This approach removes uncertainty about parts of model structure other than the parameters of interest. In this way brittle assumptions about the model structure can be avoided.

In order to carry out family level inference the specified models need to be assigned to a family. The families of models must be non-overlapping and their union must equal the whole model space investigated. In this way many models can be used to answer a specific question or hypothesis.

### 3.2.3 Inference on parameters

The last level of inference that can be carried out is inference on a specific parameter within a network (Stephan et al., 2010). This is particularly useful if differences in connectivity between two populations are of interest, i.e. differences between patients and controls. Comparison of a given parameter is straightforward to do if there is a clear winning model for both the patients and controls and that this model is the same for both groups. Then parameters can be entered in a simple two sampled t-test or ANOVA, depending on the question. However, if inference of the model structure is carried out separately for patients and controls, results might show that the model that fits the data best is different for patients and controls. In this case, inference at the parameter level is not as straightforward since parameters acquired from different models can not be compared across groups. This is due to the fact that parameters are conditioned on the specific model tested. There are several different ways to avoid this issue. One is to use Bayesian model averaging (BMA) (Penny et al., 2010). BMA weights the contribution of each model to the mean by its evidence. BMA can be carried out across the whole model space or across a family. In this way comparisons of parameters can be carried out even though the winning model in the two groups is not the same. However, it should be noted that the models averaged should be the same across groups. In equation (3.14), BMA is given within a family.  $n$  represents a given subject and  $f_k$  contains all models belonging to family  $k$ .

$$p(\theta_n|Y, m \in f_k) = \sum_{m \in f_k} q(\theta_n|y_n, m)p(m_n|Y) \quad (3.14)$$

$q(\theta_n|y_n, m)$  is the approximation to  $p(\theta_n|Y, m)$  being the posterior of the parameters for subject  $n$ . Finally  $p(m_n|Y)$  is the posterior probability that model  $m$  is used by subject  $n$ .

Another way to avoid dealing with different winning models in two groups is to perform the model selection in a pooled group. In this way a common model is identified that fits the pooled group and parameter inference can be performed within that model. Third option is to define only one model and fit this to the patients and controls to enable connection-by-connection comparison. However,

the latter option requires that very strong hypothesis about the model structure is present.

### 3.2.4 Model Space

When using DCM it is very important to carefully motivate the model space that one wants to make inferences about (Stephan et al., 2010). In principle an infinite number of models exists and there is no such thing as a true model. However, when comparing models against each other it is possible to say which one performs best. The models are specified in terms of included sources that are believed to account for the experimental effect of interest as well as how these areas are connected to each other. One can then build models to test specific hypotheses or questions about the network. A research question could be; is feedback connections within a given network necessary to explain the experimental effect? Models with and without feedback connections can then be tested against each other to see if models with feedback connections explain the data better than models without the feedback connections. The anatomical structure of the networks is usually guided by neuroimaging studies that have located the brain areas involved in the task of interest. It is important to note that results obtained via DCM crucially rely on the explored models.

## 3.3 Summary of Paper A and B

Two of the papers included in this thesis used the methods described in the above sections, paper A and paper B. A summary of the two papers can be found in the below two subsections and the full versions are found in Appendix A and B.

### 3.3.1 Reduced adaptation and top-down connectivity in 22q11.2 Deletion Syndrome

In this paper we investigated the underlying neural mechanism of change detection in 22q11.2 deletion carriers. While 19 22q11.2 deletion carriers and 27 healthy controls engaged in a roving pitch MMN paradigm, we measured high

density EEG.

Since, as mentioned in section 3.1.2, it has been consistently found that MMN is reduced in schizophrenia, and that 22q11.2DS are a schizophrenia high-risk group, we hypothesized that the 22q11.2 deletion carriers would also express a reduction in MMN responses. In order to test this hypothesis we conducted a conventional analysis of MMN amplitudes in the two groups. Further, we conducted a spatio-temporal analysis searching for difference across all sensors as well as the whole peri-stimulus time of the two conditions; standard and deviant and groups; 22q11.2 deletion carriers and healthy controls respectively. While we found no group difference using the conventional approach comparing MMN amplitudes, the spatio-temporal analysis revealed a remarkable group difference in the time window of the N1 component. The effect was driven by 22q11.2 deletion carriers showing increased (negative) responses as compared to the healthy controls.

Given that schizophrenia has been associated with the disconnection hypothesis where especially top-down processing is impaired as compared to healthy controls, we hypothesized that this top-down processing would be limited in the 22q11.2 deletion carriers in the network underlying MMN processing. To test this hypothesis, we applied DCM to assess effective connectivity between pre-specified sources known to be involved in the generation of MMN. The regions included were bilateral primary auditory cortex (A1), bilateral superior temporal gyrus (STG) and finally bilateral inferior frontal gyrus (IFG). We formulated families of DCMs according to their type of connections and by comparing these families of models, we could test which of these families best explained the observed responses. We found that a family with both forward, backward and inter-hemispheric connections explained data best when pooling controls and 22q11.2 deletion carriers. Within this family we carried out Bayesian model averaging to compare connectivity parameters between the two groups. Here, results pointed towards a reduced intrinsic connectivity within right A1 as well as reduced top down connectivity from right IFG to right STG in the 22q11.2 deletion carriers when comparing to controls. We interpret this reduction in top down connectivity as 22q11.2 deletion carriers having a reduced ability to pass down predictions from higher hierarchical areas to lower level areas. Although the significance of the two connections did not survive correction for multiple comparison using the conservative Bonferroni, previous results have found the exact same two connections to be affected in schizophrenia patients. However, to make any conclusions, a follow up study is needed with a higher number of subjects.

We explored if the observed results were correlated with the total number of negative symptoms in the 22q11.2 deletion carriers. None of the results correlated with these.

Altogether, we showed in this study that there is no difference between the included 22q11.2 deletion carriers and healthy controls in frequency MMN responses

at the ERP level. However, 22q11.2 carriers show an enhanced response to tones per se, as seen from larger N1 amplitudes. DCM suggested a trend towards a lack of predictive behaviour indicated by a reduction of top down connectivity.

### 3.3.2 Reduced repetition suppression in 22q11.2 deletion syndrome

In this paper we extended the analysis from paper A with a parametric DCM. Instead of focusing purely on the MMN and the standard and deviant leading to this, we here focused on the memory trace, i.e. all tones in the roving paradigm. Hence, the aim of this study was to look at the effect of repeated auditory stimuli; repetition suppression in the context of a roving MMN paradigm. Repetition suppression has been explained recently within the framework of predictive coding. Further, the processes involved in predictive coding appears to be disrupted in schizophrenia, especially at the level of top down processing (see section 3.1.2). Therefore, we hypothesised that responses to repeated tones would show a parametric modulation of repetition-dependent changes in effective connectivity in the form of a u-shaped function. Hence, a decrease within the first number of repetitions capturing changes due to habituation or adaptation, followed by an increase representing prediction of a new event, in accordance with predictive coding. Further, we hypothesised that this modulation is disrupted in 22q11.2 deletions carriers, reflecting a disruption of the ability to adapt to the environment.

The above mentioned hypotheses was tested by introducing three different parametric effects; u-shape, decaying exponential and growing exponential. By introducing these parametric effects, we formulated families of DCMs where each family tested one specific parametric effect. By comparing these families representing the parametric effect, we could test the hypothesis about repetition-dependent changes. Within each family, the same DCM models were defined as in study 1 (A). We further looked at the scalp level how the 22q11.2 deletion carriers differed from controls in the responses to repeated tones.

DCM revealed that repetition-dependent changes in effective connectivity showed a favour for the family with the u-shaped modulation as compared to the two competing families; decaying exponential and growing exponential. Within the family with the u-shaped modulation, we compared the connectivity parameters obtained using BMA between the two groups. Results suggested that 22q11.2 deletion carriers have stronger modulation compared to controls in the forward connection from left STG to left IFG. Within the predictive coding framework, this indicates that 22q11.2 deletion carriers send more prediction errors than controls, meaning that they are less adaptive to the environment. However, the

significance of the connection did not survive correction for multiple comparison, which means that a follow up study with a larger cohort is needed to draw a definite conclusion.

The spatio-temporal analysis at the sensor level revealed that 22q11.2 deletion carriers showed an enhanced response to the repeated tones at 90 ms, whereas a reduction of responses to tones were found at 180 ms. The enhanced response at 90 ms suggests that 22q11.2 deletion carriers have a reduced ability to suppress the repeated stimuli, whereas the enhanced response at 180 ms, might indicated that 22q11.2 deletion carriers have a reduced ability to classify the stimuli. Both findings is in line with findings in schizophrenia patients. Altogether, results from the current study indicate that 22q11.2 deletion carriers might not process repeated auditory stimuli according to predictive coding as observed in controls, meaning that they have a reduced ability to suppress repeated stimuli.



## CHAPTER 4

# Evoked Gamma Oscillations

---

This chapter presents work related to study 3 regarding cortical integration of information assessed using an auditory steady state paradigm in 22q11.2 deletion carriers and healthy controls. In the first section, 4.1, the reader will be provided with an introduction to the auditory paradigm used, whereafter a description of the methods used will be provided in section 4.2. Finally, the chapter is rounded off by describing the findings of the third contribution of the thesis; paper C.

## 4.1 Auditory Steady State Responses

When auditory stimuli are presented periodically with constant frequency and amplitude content, the brain is able to generate auditory steady state responses (ASSRs) (Plourde et al., 1991; Picton, 2010). The ASSR has its maximum around 40 Hz, which indicates that the brain has an optimal resonance frequency for neurophysiological processes (Galambos et al., 1981; Azzena et al., 1995). One way to evoke ASSRs is by repetitive stimulation with a click train at a certain frequency. This means that for a click train of for example 40 Hz, 40 clicks are delivered in 1 second. In figure 4.1, the stimuli used in the work of this thesis



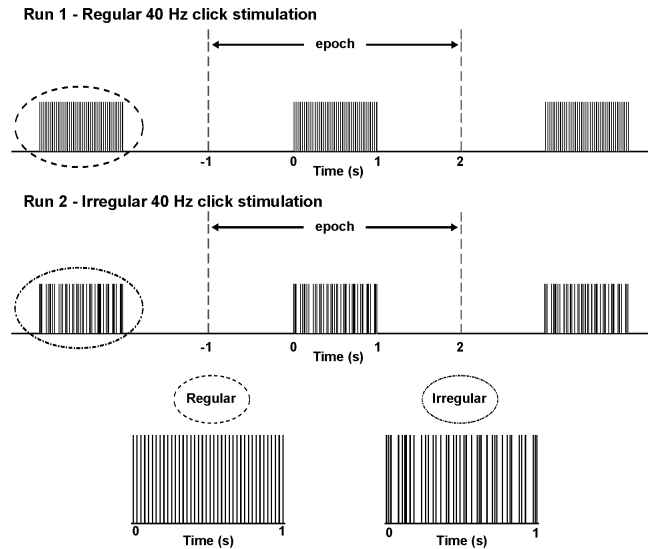

**Figure 4.1:** Experimental design of the ASSR used to evoke steady state gamma responses. The click trains were applied either at a regular ISI of 25 ms (run 1) or an ISI jittered around 25 ms (run 2). Stimulation lasted for 1 s, followed by a pause of 2 s (i.e. SOA = 3 seconds).

is shown, representing a 40 Hz click train. As can be seen from the figure, the stimulation was applied with a stimulus onset asynchrony (SOA) of 3 seconds. Here, an irregular 40 Hz click train was applied as well testing whether temporal regularity of the 40 Hz train was critical to evoke ASSR. In this way we could test for differences in steady state as well as transient (non-steady state) responses.

### 4.1.1 Underlying Mechanisms

In order to be able to capture network oscillations, neuronal regular and synchronised activity is required. If several neurons fire regularly and synchronously with each other, a fluctuating field potential will be generated which is measurable with electrodes on the scalp (Bartos et al., 2007). The synchronous activity has shown to be crucial for sensory binding and temporal encoding (Buzsáki, Chrobak, 1995).

The underlying mechanisms for the ability to fire regularly and synchronously

have been widely studied where one of the key ingredients has shown to be GABA<sub>A</sub> receptor mediated inhibition (Buzsáki, Wang, 2012). The GABAergic interneurons exerts a finely timed inhibition onto the pyramidal cells constituting inhibitory interneurons (Traub et al., 2003; Bartos et al., 2007; Sohal et al., 2009). Hence, the presence of the neurotransmitter GABA is believed to be crucial for the generation of gamma oscillations. This has been further clarified by showing reduced gamma oscillations and cognitive impairment when a loss of GABA-mediated inhibition was present, see (Gonzalez-Burgos et al., 2011) for a review.

Parvalbumin is a calcium binding protein present in GABAergic interneurons (Cowan et al., 1990). On the fast-spiking parvalbumin positive GABAergic interneurons, NMDA receptors are located. Those receptors have recently been shown to play a crucial role in the generation of cortical gamma oscillations (Carlén et al., 2012). Sivarao, and colleagues (Sivarao, 2015; Sivarao et al., 2016) suggest that the ASSR may be used as a biomarker for cortical NMDA function.

### 4.1.2 ASSR and Schizophrenia

It is consistently found that the ASSR is reduced in schizophrenia (Brenner et al., 2003; Light et al., 2006; Krishnan et al., 2009; Spencer et al., 2009; Uhlhaas, Singer, 2010). A pivotal study by (Kwon et al., 1999) showed that the ASSR was selectively reduced at 40 Hz in schizophrenia patients, but not at 20 Hz and 30 Hz. Recently it has also become evident that the ASSR is already affected in first-episode psychosis (Symond et al., 2005; Spencer et al., 2008), and even in non-affected first degree relatives (Hong et al., 2004; Rass et al., 2012). A very recent meta analysis assessed the stability of the 40 Hz ASSR impairment in schizophrenia (Thuné et al., 2016) concluding that both power and phase locking are robust deficits in schizophrenia.

It is suggested that GABAergic neurotransmission is altered in schizophrenia (Lewis et al., 1999, 2005). Different studies have assessed the levels of GABA in schizophrenia patients where in (Marsman et al., 2014) lower levels of prefrontal GABA levels were reduced in patients with schizophrenia as compared to healthy controls. Further, the study by (Chen et al., 2014) showed a correlation between prefrontal GABA levels and peak gamma frequency, when using both EEG for measuring gamma oscillations and magnetic resonance spectroscopy to measure prefrontal GABA levels. Altogether, this suggests that the robust finding of reduced cortical gamma oscillatory activity in schizophrenia could be explained by a reduction of the GABA levels.

No studies, have to my knowledge, been investigating ASSR in 22q11.2DS.

## 4.2 Time-frequency Analysis

The most common approach to study event related brain oscillations is to do a spectral decomposition of the EEG signal (Roach, Mathalon, 2008). With this approach, the EEG signal is decomposed into both magnitude and phase information for each frequency and time point. The oscillatory patterns of the brain are non-stationary and to overcome this issue, the signal can be split into windows where the signal is then assumed stationary.

There are many ways to decompose the signal into time-frequency components, including the short time Fourier transform (STFT) (Goswami, Chan, 2010; Gabor, 1946) and the continuous wavelet transform (Mallat, 1989; Goswami, Chan, 2010). The STFT uses the same window length for all frequencies resulting in a poor trade-off between resolution in time and frequency across frequencies. A way to overcome this poor trade-off between resolution in time and frequency is the wavelet transform where the size of the windows are varied across frequencies. Again different kinds of wavelets exists, however, the most common used in time-frequency analysis of EEG signals is the complex Morlet wavelet (Roach, Mathalon, 2008; Herrmann, Grigutsch, 2005) since these are well suited for identifying frequency information at a specific time (Cohen, 2014).

### 4.2.1 Complex Morlet Wavelet

In order to compute the wavelet transform of a signal  $x(t_n)$ , the signal  $x(t_n)$  is convolved with a mother wavelet function. This convolution is given in (4.1), where  $\tilde{\psi}(t_n)$  is the conjugated motherwavelet given in (4.2), (Herrmann, Grigutsch, 2005). In (4.1),  $a$  is a scaling parameter controlling the width of the wavelet and  $b$  is the time instance at which the wavelet is estimated.  $f$  in (4.2) represents the center frequency of the wavelet.

$$X(b, a) = \frac{1}{\sqrt{a}} \sum_n \tilde{\psi}\left(\frac{t_n - b}{a}\right)x(t) \quad (4.1)$$

$$\psi(t) = \frac{1}{\sqrt{2\pi\sigma^2}} \exp^{i2\pi ft} \exp^{-\frac{t^2}{2\sigma^2}} \quad (4.2)$$

As can be seen from (4.2), the mother wavelet is a Fourier transform multiplied with a Gaussian window. This means that the wavelet has its maximum value at its center and then decaying towards the edges. The standard deviation of the Gaussian window  $\sigma$ , is reciprocally related to the frequency. Because of this, the

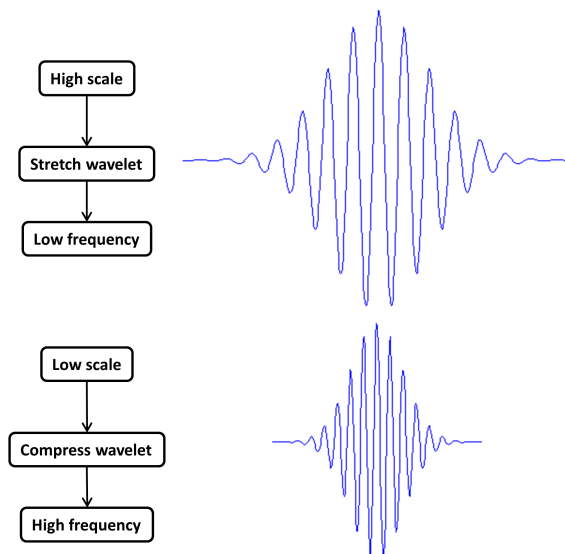

**Figure 4.2:** Effect of the scaling parameter  $a$ . In the top row the the scaling parameter is high, resulting in a stretch of the wavelet, thereby catching low frequencies. In the bottom the scaling parameter is low, resulting in a compressing of the wavelet which thereby catches higher frequencies. Note that for simplicity reasons only the real part of the wavelet is shown in this plot.

number of wavelet cycles is kept constant for all frequencies and given by  $6\sigma f$ , (Herrmann, Grigutsch, 2005). The EEG signal of interest is wavelet transformed by shifting the wavelet along the signal while extracting the wavelet coefficients i.e. a convolution between the wavelet and the EEG signal. This is then carried out for various values of the scale parameter to cover the frequency range of interest. The scale parameter is inversely proportional to the frequency which is also evident from figure 4.2. Increasing the scaling parameter results in a stretch of the wavelet. The stretch of the wavelet makes the frequency resolution good because of the many time points used in the calculation. However, this also results in a lower time resolution since the cycles of the wavelet are spread out in time. Conversely, decreasing the scaling parameter narrows the wavelet and therefore results in a good time resolution but poorer frequency resolution.

With a fixed number of cycles, and thereby varying window lengths, it is possible to obtain a good trade-off between resolution in time and frequency with the wavelet transform. This takes advantage of the fact that bursts of high frequencies vary rapidly in time as compared to low frequencies.

## 4.2.2 Inter Trial Phase Coherence

It is believed that phase synchrony plays a central role in cortical information processing (Varela et al., 2001; Herrmann, Grigutsch, 2005). Therefore extraction of this information can give an indication if this quality is impaired in a disease group as compared to a healthy control group. The inter trial phase coherence (ITPC), first introduced as the *phase locking factor* by (Tallon-Baudry et al., 1996), is given in (4.3) for a given channel ( $ch$ ), frequency ( $f$ ) and time ( $t$ ).

$$ITPC(ch, f, t) = \frac{1}{N} \left| \sum_{n=1}^N \frac{X(ch, f, t, n)}{|X(ch, f, t, n)|} \right| \quad (4.3)$$

In (4.3),  $n$  refers to a single epoch and  $N$  to the total number of epochs. ITPC gives the distribution of phases for each frequency and time for a specific channel. Values of ITPC ranges between 0 and 1, with 1 being perfectly synchrony between trials and the time-locked events, and 0 being no synchrony at all across trials (Delorme, Makeig, 2004). Compared to power, ITPC is less sensitive to noise. Furthermore, the ITPC is not affected by the  $1/f$  relationship that exists describing high energy at low frequencies and low energy at higher frequencies.

## 4.2.3 Power

Event related changes in spectral power for a specific channel ( $ch$ ), frequency ( $f$ ) and time ( $t$ ) can be assessed using (4.4).

$$Power(ch, f, t) = \frac{1}{N} \sum_{n=1}^N |X(ch, f, t, n)|^2 \quad (4.4)$$

The power is highly affected by the  $1/f$  relationship, which is why the power is usually baseline corrected. In the work of this thesis, the power is corrected by dividing with power of the baseline.

## 4.3 Summary of Paper C

In paper C we investigated the ASSR in a cohort of 18 22q11.2 deletion carriers and 27 healthy controls without the deletion. Since ASSR at 40 Hz has been consistently found to be reduced in schizophrenia (see section 4.1.2), we hypothesised that the 40 Hz ASSR would be attenuated in the 22q11.2 deletion carriers as compared to healthy controls.

In order to test this hypothesis, we recorded cortical ASSR to 40 Hz train of clicks in 22q11.2 deletion carriers and healthy controls comparable in age distribution and sex ratio. The trains of 40 Hz clicks were given either at a fixed inter-stimulus-interval (ISI) or at a jittered ISI where the jittered trains of clicks served the purpose of a control stimuli for temporal regularity.

Both power and ITPC of the ASSR were assessed using conventional time-frequency approaches in the form of a wavelet transform. While the healthy controls expressed a stable ASSR at 40 Hz, the 22q11.2 deletion carriers showed reduced values of both power and ITPC of the ASSR. In addition, we found that the individual values of ITPC correlated with the expression of negative symptoms in the 22q11.2 deletion carriers. To my knowledge it is the first time that ASSR has shown to be reduced in 22q11.2DS. The results therefore highlight the emerging importance of gamma-band oscillations in understanding the neurophysiological characteristics of 22q11.2DS and schizophrenia. A full version of the paper can be found in Appendix C.



# Discussion and Conclusion

---

The main objective of the work covered in this thesis was to study electrophysiological differences between 22q11.2 deletion carriers, a genetic high-risk group for schizophrenia and healthy non carriers. The search for differences in electrophysiological signatures was performed using two different auditory paradigms; MMN and ASSR while measuring EEG. The main objectives were divided into three studies.

Study 1 aimed at looking for differences between MMN responses in the two groups as well as looking at the underlying effective connectivity network of change detection. Study 2, then extended study 1 to look at the underlying network of repetition suppression. In both study 1 and 2 DCM was used to assess effective connectivity. The use of DCM imposes some methodological considerations. One very important thing when employing DCM is the motivation of the investigated model space. In principle an infinite amount of models one can set up exists and it is therefore important to have clear hypotheses about what you want to test and then build models to test these hypotheses. This implies that the results you are getting when using DCM, completely relies on the models tested. However, if the model space is carefully motivated, DCM is a very unique tool to test specific hypotheses of an underlying system.



The roving MMN paradigm used in study 1 and 2 was a frequency roving paradigm meaning that the break in regularity is caused by a change in the frequency of the sinusoidal tones used. Frequency MMN has been shown to be a robust finding in chronic schizophrenia (Umbricht, Krljesb, 2005). However, more and more evidence points to duration MMN as a more promising candidate when searching for biomarkers in schizophrenia, since duration MMN is reduced in first-episode schizophrenia whereas pitch MMN is not, according to the meta analysis (Haigh et al., 2016). In line with this, duration MMN has been found to be reduced in 22q11.2 deletion carriers, see (Baker et al., 2005), although this was not replicated in (Zarchi et al., 2013). Therefore, it would have been very interesting if a duration MMN paradigm was tested on the 22q11.2 deletion carriers included in this thesis. In fact, as can be seen from figure 1.1 in the introductory chapter, the test battery also included a multiplex MMN paradigm. In that paradigm both frequency and duration deviants were present. However, the full battery of the tests that subjects had to go through were quite extensive for the 22q11.2 deletion carriers and therefore only a few of the 22q11.2 deletion carriers made it through all paradigms. Because of the low number of subjects in the multiplex paradigm, including the duration deviant, this paradigm was not part of the current thesis. The abovementioned results concerning the duration MMN as a more promising candidate for a biomarker, are focused on conventional approaches for assessing MMN responses, i.e. assessing the amplitudes or latencies of the MMN responses and comparing these across groups. The two studies using the roving frequency MMN paradigm in the current thesis, assessed effective connectivity. While we did not observe group differences in the amplitudes of the frequency MMN response, results indicated that 22q11.2 deletion carriers have alterations in effective connectivity. Hence, even though the responses observed at the scalp level do not seem to differ between groups, the underlying processes generating these might differ. The search for a biomarker for schizophrenia using the MMN paradigm might therefore call for more advanced types of analyses.

This also goes in line with one of the hypotheses about the underlying pathologies of schizophrenia; *The disconnection hypothesis* (Friston, 1998). The disconnection implies that the ability to properly integrate functionally specialized systems is impaired. This functional integration between brain areas relies on the influence those areas have on each other. Since effective connectivity is an expression of the influences one neural system exerts over another, it is clear that effective connectivity is a useful measure in relation to schizophrenia.

In study 1 and 2, group differences in responses to tones were found at the fronto-central electrodes at 90 ms, falling within the usual timing of the N1 component. The effect was driven by more negative responses for the 22q11.2 deletion carriers as compared to the controls. This has previously been found in a 22q11.2DS

---

cohort (Rihs et al., 2013) and our results can therefore be seen as a replication of this. Relating this to what is seen in studies in schizophrenia patients the N1 component has been found to be reduced in schizophrenia, as well as first episode and first-degree relatives (Foxe et al., 2011; Umbricht et al., 2003). However, several studies have also failed to show this reduction, see (Rosburg et al., 2008) for a review. One of the explanations why the findings of the N1 component are not consistent are factors such as; inter stimulus interval, medication and attention which all play a crucial role in the results of the N1 findings. The finding of an enhanced N1 component in the 22q11.2 deletion carriers might suggest a general impairment in the processing of sensory information and a reduced ability to adapt to the environment. However, future studies are needed to delineate this.

In study 3 we used an ASSR paradigm to assess information about evoked oscillations within the gamma range (40 Hz) in 22q11.2 deletion carriers as compared to healthy controls. We used the complex Morlet wavelet transform to assess both power and ITPC for the ASSR and found a reduction in these measures in the 22q11.2 deletion carriers as compared to the controls. Crucially, the ITPC correlated with the individual expression of negative symptoms in the 22q11.2 deletion carriers. The results from this study confirm and extend previous studies investigating the ASSR in non-psychotic first-degree relatives of patients with schizophrenia (Hong et al., 2004; Rass et al., 2012). Our finding, together with the existing literature, suggest that the ASSR is impaired even prior to psychosis. Since GABA<sub>A</sub> receptor-mediated inhibition plays a substantial role in the underlying mechanisms of gamma oscillations (Buzsáki, Wang, 2012), this might indicate that the reduced ASSR observed in 22q11.2 deletion carriers could be due to a loss of GABA mediated inhibition. The levels of GABA have previously been shown to correlate with gamma peak frequency (Chen et al., 2014). However, a study elucidating the levels of GABA would be needed in order to test if the GABA levels in 22q11.2DS are reduced as well as correlated with the gamma oscillations.

19 22q11.2 deletion carriers were included in study 1 and 2 whereas study 3 comprised 18 deletion carriers. One could argue that the reliability of the presented results would have benefited from larger sample sizes, especially the correlation analysis applied in study 3. However, with this being said, it should be mentioned that the ASSR investigated in study 3 showed a really strong signal, even though artefact rejection was kept at a minimum level. The MMN responses however, were a bit more noisy. Hence, if these results should be investigated in a future study on a single subject level, the ASSR seems more reliable. Though, this was not quantified in the current thesis. Future studies should aim at including higher

sample sizes.

The main objective of identifying functional abnormalities in 22q11.2DS using the two paradigms MMN and ASSR has been met. A potential candidate for a biomarker for schizophrenia according to the results presented in this thesis is the reduced power and ITPC of the ASSR. The reasoning for implying these is that ITPC showed an association with negative symptoms in the 22q11.2 deletion carriers. The results of the current thesis therefore contribute with knowledge about the use of those measures in future studies searching for biomarkers. However, it is very important to point out that in order to confirm that these could potentially be used as biomarkers for schizophrenia, this deficit should be present in all of the (max 41%) 22q11.2 deletion carriers that will develop psychosis. Hence, a follow up study is needed to see if there exist a correlation between those found measures and who actually converts to psychosis.

The connectivity alterations found in study 1 and 2 are interesting and suggestive, but since none of these survived correction for multiple comparison, these can not be suggested to use as a candidate for a biomarker at this point. More studies looking at effective connectivity in 22q11.2DS are needed.

In conclusion, the results presented in this thesis contribute to increasing the understanding of 22q11.2DS and the electrophysiological abnormalities associated with the syndrome. Further, the results can hopefully with time and more studies, contribute in the search of biomarkers for schizophrenia.

APPENDIX A

Reduced adaptation and  
top-down connectivity in  
22q11.2 deletion syndrome

---

## Reduced adaptation and top-down connectivity in 22q11.2 Deletion Syndrome

Kit Melissa Larsen <sup>a,b,c,d</sup>, Morten Mørup <sup>b</sup>, Michelle Rosgaard Birknow <sup>c,d,e</sup>, Elvira Fischer <sup>a</sup>, Oliver Hulme <sup>a</sup>, Anders Vangkilde <sup>c</sup>, Henriette Schmock <sup>c</sup>, William Frans Christiaan Baaré <sup>a</sup>, Michael Didriksen <sup>e</sup>, Line Olsen <sup>c,d</sup>, Thomas Werge <sup>c,d,f</sup>, Hartwig Siebner <sup>a,f,g</sup>, Marta I. Garrido <sup>h,i,j</sup>.

<sup>a</sup> Danish Research Centre for Magnetic Resonance, Centre for Functional and Diagnostic Imaging and Research, Copenhagen University Hospital Hvidovre, Hvidovre, Denmark

<sup>b</sup> DTU Compute, Cognitive Systems, Technical University of Denmark, Lyngby, Denmark

<sup>c</sup> Institute of Biological Psychiatry, Mental Health Centre Sct. Hans, Copenhagen University Hospital, Boserupvej 2, DK-4000 Roskilde, Denmark

<sup>d</sup> iPSYCH, The Lundbeck Foundation Initiative for Integrative Psychiatric Research

<sup>e</sup> Synaptic Transmission, H. Lundbeck A/S, Ottiliavej 9, DK-2500 Valby, Denmark

<sup>f</sup> Department of Clinical Medicine, Faculty of Health and Medical Sciences, University of Copenhagen, Copenhagen, Denmark

<sup>g</sup> Department of Neurology, Copenhagen University Hospital Bispebjerg, Copenhagen, Denmark

<sup>h</sup> Queensland Brain Institute, The University of Queensland, St Lucia 4072, Brisbane, Australia

<sup>i</sup> Centre for Advanced Imaging, The University of Queensland, St Lucia 4072, Brisbane, Australia

<sup>j</sup> Australian Research Council Centre of Excellence for Integrative Brain Function Centre of Excellence for Integrative Brain Function, The University of Queensland, St Lucia 4072, Brisbane, Australia

## **Abstract**

22q11.2 deletion syndrome (22q11.2DS) is one of the most common copy number variants and confers a markedly increased risk for schizophrenia. Therefore, 22q11.2DS is a homogeneous genetic liability model which enables studies that intent to identify functional abnormalities that may precede disease onset. The mismatch negativity (MMN), a brain marker of change detection, is known to be reduced in people with schizophrenia compared to healthy controls. Using dynamic causal modelling (DCM), previous studies showed that top-down (i.e. from higher order areas to lower order areas) effective connectivity is reduced in schizophrenia relative to healthy controls in tasks that involve formulation of predictions. In addition, top-down connections have shown to be crucial in oddball tasks. In the search for potential early neural risk markers for schizophrenia we investigated the neural basis of change detection in a group with 22q11.2DS. We recorded high-density EEG from 19 non-psychotic 22q11.2 deletion carriers in the age range 12-25 years, as well as from 27 healthy non-carriers with comparable age distribution and sex ratio, while they listened to a sequence of sounds arranged in a roving oddball paradigm. Whole-scalp spatiotemporal analysis of responses to the tones revealed a greater fronto-temporal N1 component in the 22q11.2 deletion carriers, which suggest a failure to suppress responses to repeated stimuli. Dynamic causal modelling pointed to group differences in the intrinsic connection within right primary auditory cortex as well as in the backward connection from right inferior frontal gyrus to right superior frontal gyrus. Critically, the disruption of the very same connections has been implicated in patients with schizophrenia. Our findings suggest that connectivity reductions in intrinsic and backward connections, which are associated with deficits in adaptation and predictive mechanisms, respectively, may be already apparent prior to illness onset.

**Keywords:** 22q11 Deletion Syndrome, Dynamic causal modelling, EEG, Mismatch negativity, N1 component

**Abbreviations:** DCM = Dynamic Causal Modelling, MMN = Mismatch Negativity, 22q11.2DS = 22q11.2 deletion syndrome

## Introduction

The search for a biomarker for schizophrenia has received remarkable attention during the last decades. Identification of an early risk marker could have a great impact by both leading to an early diagnosis of the disease as well as a more effective treatment. However, the complex underlying pathology of schizophrenia poses big challenges to this endeavor. Early disease diagnosis and thereby early treatment is clinically valuable as it has shown a positive effect on clinical outcomes and everyday functioning in schizophrenia patients (Larsen *et al.*, 2010). The 22q11.2 deletion is one of the most common copy number variants (CNV) with a prevalence of 1:2000 to 1:4000 (Goodship *et al.*, 1998; Oskarsdóttir *et al.*, 2004; Robert J. Shprintzen, 2005). The 22q11.2 deletion syndrome (22q11.2DS) is characterized by multiple somatic disorders, cognitive deficits and learning disabilities (Karayiorgou *et al.*, 2010; Robin and Shprintzen, 2005). Further, the syndrome is associated with hearing loss (Jiramongkolchai *et al.*, 2016). Recent studies have shown that people carrying the deletion are at a higher risk for several neurodevelopmental disorders including autism, ADHD, and schizophrenia, (Bassett *et al.*, 2008; Karayiorgou *et al.*, 2010; Purcell *et al.*, 2009; Schneider *et al.*, 2014; Stefansson *et al.*, 2008). In addition, results from a new nationwide Danish study show that people diagnosed with 22q11.2DS had approximately eight times higher risk of developing schizophrenia spectrum disorders as compared to the general population (Vangkilde *et al.*, 2016). For this reason, investigating the neurobiology of 22q11.2 deletion carriers can provide important insights into the pathogenesis of schizophrenia and potential disease risk markers.

It is very well established that people with schizophrenia show a reduced mismatch negativity (MMN) at fronto-central electrodes over the scalp when assessed with electroencephalography (EEG) (Catts *et al.*, 1995; Michie, 2001; Näätänen and Kähkönen, 2009; Umbricht and Krljesb, 2005). In addition, a reduced MMN response is observed in first episode psychosis, (Atkinson *et al.*, 2012; Hsieh *et al.*, 2012), first degree relatives (Jessen *et al.*, 2001; Michie *et al.*, 2002) and further shown to be a promising biomarker for psychosis prediction (Bodatsch *et al.*, 2015). Only a limited number of studies have investigated the MMN in 22q11.2 deletion carriers (Baker *et al.*, 2005; Zarchi *et al.*, 2013). Baker and colleagues (Baker *et al.*, 2005) found that duration MMN was reduced at frontal electrodes and intact at temporal sites, which is consistent with findings in the schizophrenia literature (Baldeweg *et al.*, 2002). In contrast, Zarchi and colleagues (Zarchi *et al.*, 2013) failed to replicate this finding but found that Gap-MMN amplitudes in the 22q11.2DS group predicted the negative symptoms scores (from the Positive and Negative Syndrome Scale, PANSS) where smaller MMN amplitudes were associated with higher scores of the PANSS. Notably, the disease states of the 22q11.2DS groups in the two mentioned studies deviate from each other. In (Baker *et al.*, 2005) no subjects met criteria for a diagnosis of psychotic disorder, whereas in (Zarchi *et al.*, 2013) a proportion of the subjects (14.63%) were diagnosed with psychotic disorders and three of these met the DSM-IV-TR for schizophrenia.

The MMN is evoked in oddball paradigms, whereby standard stimuli form a rule that is occasionally violated by oddball events. MMN is believed to reflect an index of change-detection

(Näätänen, 1995), and it is defined as the negative deflection in the event-related potential (measured with EEG) peaking around 100-250ms after the change onset, that emerges when subtracting the response to a standard tone from the response to a deviant tone, (Näätänen, 1995; Näätänen *et al.*, 2007). Approaches to modelling MMN using Dynamic Causal Modelling (DCM) have accommodated two competing hypotheses for the underlying mechanism of MMN: model-adjustment and adaptation (Garrido *et al.*, 2008). Predictive coding (Rao and Ballard, 1999) has unified these views and reframed MMN in terms of an interplay between current inputs and predictions based on a learnt regularity (Garrido *et al.*, 2009a). The network implementation of these processes involve bottom-up and top-down connections that link lower-level sensory areas with higher-order cortical areas (Friston, 2003). This interplay appears to be disrupted in schizophrenia (Adams *et al.*, 2013; Dima *et al.*, 2010, 2012; Fogelson *et al.*, 2014) as well as in unaffected relatives (Ranlund *et al.*, 2016) especially at the level of top-down processing, i.e., connections from higher order areas to lower order areas. Further, functional disintegration among brain regions phrased as “*The disconnection hypothesis*” is believed to be one of the core pathologies of psychosis (Friston, 1998), which motivates the use of DCM in addition to conventional MMN analysis in sensor space, i.e., electrode level, in the present study.

In this study, the neuronal connectivity underlying change detection was assessed in a group of young non-psychotic 22q11.2 deletion carriers as well as in a healthy age- and sex-comparable control group using DCM. Given that schizophrenia patients show reduced MMN responses, and that 22q11.2DS are a schizophrenia high-risk group, we hypothesized that the 22q11.2 deletion carriers would also express a reduction in MMN responses. Based on previous identified neural generators of MMN, we formulated families of DCMs according to their type of connections, to test the hypothesis that 22q11.2 deletion carriers would express less top down predictions within the network accounting for MMN, compared to healthy non-carriers. Finally, we explored the possibility that effective connectivity in 22q11.2 deletion carriers as well as MMN amplitudes is associated with the individual negative symptoms score in the 22q11.2 deletion carriers.

## Materials and Methods

### Participants

We included 19 22q11.2 deletion carriers without a current or previous history of schizophrenia. All carriers had a verified deletion within the 3 Mb region at chromosome 22q11.2. Our control group included 27 healthy individuals without the 22q11.2 deletion. Groups were comparable with respect to sex ratio (male/female controls: 18/9, carriers: 13/6,  $\chi^2 = 0.02$ ,  $p = 0.90$ ) and age distribution (controls age range: 12-25 years; mean age: 15.96, standard deviation (SD) = 2.71 years; 22q11.2 mean age: 15.47, SD 2.41 years,  $t_{44} = -0.63$   $p = 0.53$ ).

All participants were evaluated for the presence of current psychiatric disorders according to the International Classification of Diseases (ICD-10) system. Diagnoses of affective disorder, anxiety, and disturbance of activity and attention/attention deficit disorder without hyperactivity were



provided by use of the Mini International Neuropsychiatric Interview (Sheehan *et al.*, 1998) or the Mini International Neuropsychiatric Interview for Children and Adolescents (Sheehan and Shytle, K. Milo, J. Janavs, 2013). Reynolds Intellectual Screening Test (RIST) was used to determine intellectual functioning (Reynolds and Kamphaus, 2011). IQ below 70 was used to index intellectual disability. We used the clinical cut-off of 15 derived from the Social Communication Questionnaire lifetime form to indicate the presence of autism spectrum disorders (Rutter *et al.*, 2003, 2005). The Structured Interview for Prodromal Symptoms (SIPS) (McGlashan *et al.*, 2012; Miller *et al.*, 2003) was used to evaluate the presence of schizophrenia-related symptoms within four domains: positive, negative, disorganized and general symptoms. All clinical interviews were conducted by two experienced and certified clinicians.

The following exclusion criteria were applied to controls: a) schizophrenia, schizotypal and delusional disorders (ICD10 DF20-29); b) bipolar disorder (ICD10 DF30-31); c) depression (ICD DF32-33) except for a past episode of mild or moderate depression (ICD10 DF 32.0 or 32.1); d) substance abuse; or e) a first degree relative with a psychotic illness.

This study was approved by the Regional Ethical Committee of Copenhagen (project id: H-3-2012-136) and the Danish Data protection Agency (project id: 2007-58-0015). All participants underwent a verbal and written informed consent process. Participants under the age of 18 provided a verbal assent while their parents completed written consent. This study is part of a larger Danish nationwide study and an extensive description of the recruitment of participants is described in (Schmock *et al.*, 2015). As a part of this larger study, participants also underwent extensive cognitive, genetic, and clinical testing.

### **Stimuli**

Subjects were presented with an auditory roving mismatch negativity paradigm adapted from (Garrido *et al.*, 2008). The roving paradigm in this study comprised of roving sequences of sounds with the number of repetitions ranging from 1 to 9 within each sequence, and drawn from a discrete uniform distribution. The first tone in each new sequence represents a change and therefore has the role of a deviant. With repetition, however, this tone then becomes the new standard (see Figure 1). An important advantage of this paradigm, compared to classic oddball designs, is that here standards and deviants are identical and hence any differences in brain responses to these tones cannot be attributed to the stimulus itself, but to its perception. The tones comprised of pure sinusoidal tones with pitch frequency 1000 and 1200 Hz, each of 50 ms duration with a 5 ms rise and fall time. The stimuli were delivered binaurally via insert-earphones (E-A-RTONE 3A Indianapolis, US), at 85 dB Sound Pressure Level (SPL), generated with the Cogent toolbox ([http://www.vislab.ucl.ac.uk/cogent\\_2000.php](http://www.vislab.ucl.ac.uk/cogent_2000.php)) running in Matlab. During the 15 minutes of recording, subjects sat in a comfortable chair and watched a silent movie displaying underwater scenery free of any sudden or salient visual events and were instructed to ignore the sounds. Prior to the experiment, audiometric testing was performed to confirm that participants were able to hear the tones used for eliciting the event related potentials (20dB random test Oscilla USB-310

Tablet screening audiometer, Aarhus, Denmark). At 1000 Hz the observed threshold levels were (mean = 20.1, SD = 0.5) for controls and (mean = 23.4, SD = 4.0) for 22q11.2.

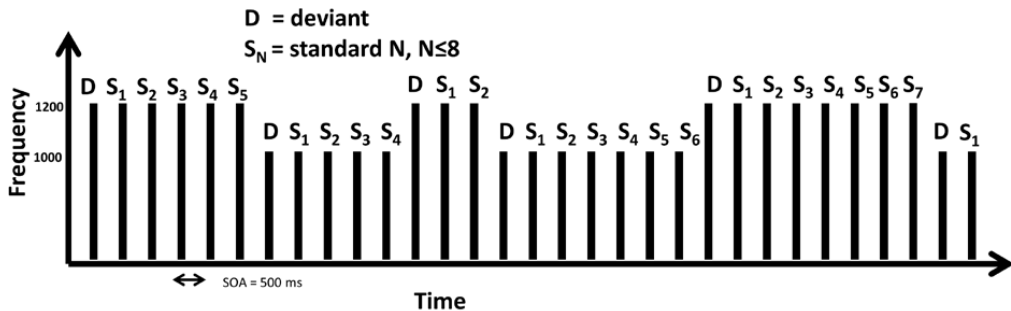

**Figure 1: Experimental design of the roving paradigm.** The first tone in each sequence is the deviant (indicated with a D) which then becomes the new standard after repetitions. S1 represents the first tone after the deviant, S2 the second tone etc. The maximum number of tones after the deviant is 8 (corresponding to the 9<sup>th</sup> tone in total). The sequences of tone vary by having a frequency of either 1000Hz or 1200Hz. The stimulus onset asynchrony is fixed at 500ms.

### Data acquisition and pre-processing

EEG data was recorded using a 128 channel ActiveTwo Biosemi System (BioSemi, Amsterdam, Netherlands) at a sampling frequency of 4096 Hz. Pre-processing was carried out using EEGLAB (Delorme and Makeig, 2004), which included referencing to the nose, bandpass filtering between 0.5Hz - 40Hz using a second order Butterworth filter, downsampling to 500Hz, and finally epoching with a peristimulus window of -100ms to 400ms. The epochs were baseline corrected using the average over the time window -100ms to -10ms. The epoched data were then exported to SPM12b where the artefact removals, mass-univariate spatiotemporal analysis as well as the DCM analysis were performed (<http://www.fil.ion.ucl.ac.uk/spm/>). The artefact removal was performed using a simple threshold approach, where epochs were rejected if their values exceeded  $\pm 100 \mu\text{V}$ . One of the subjects (belonging to the 22q11.2 group) was discarded because the majority of epochs were rejected with this approach (above 80%).

Trials were sorted according to their tone repetition number and collapsed across the two frequencies (i.e. pitch frequencies 1000 and 1200 Hz). In other words, trial number one represented the first presentation of a tone in each sequence; trial number two represented the second presentation of the tone, and so forth up until the ninth presentation. Responses to the standard were subtracted from the response to the deviant (D). This was done for the first standard (S1) up until the fifth standard (S5) in order to estimate which standard tone would produce the highest MMN response. This tone was then used as the standard tone for further analysis. We stopped at S5 since S6 to S8 had fewer than 100 trials and we wanted to guarantee a good signal to noise ratio comparable to that afforded by S1 to S5.

To enable a spatio-temporal analysis in sensor space, the epoched EEG data were converted into scalp-map images of dimension 64x64. These were obtained using interpolation followed by smoothing using a Gaussian kernel specified by a FWHM of 8 mm<sup>2</sup> in the spatial dimension and 10 ms in the temporal dimension ([8 8 10]). Single-channel MMN responses were extracted from channel C21, corresponding to Fz in the 10-20 system. We chose Fz because we had a priori knowledge that MMN produces the highest responses over fronto-central areas, (Garrido *et al.*, 2009a; Näätänen *et al.*, 2007). Before the DCM analysis was performed, data was re-referenced to the average over sensors to ensure proper source reconstruction.

### Dynamic Causal Modelling

To assess causality and directionality of the neural networks underlying tone processing DCM was conducted. DCM is a hypothesis driven method that estimates effective connectivity between specified brain areas and how this is affected by experimental factors, where effective connectivity is the influence one brain area exerts over another (David *et al.*, 2006; Friston *et al.*, 2003). DCM builds upon neural mass models that describe changes in neural activity at the source (i.e. brain area) level (Jansen and Rit, 1995). An output function, based on an electromagnetic forward model, describes how the activity at the source level is related to scalp EEG data. This can be seen in equation (eq. 1) and (eq. 2) where  $x$  represents the neural states,  $u$  is the input stimulus, and  $\theta$  are the connectivity parameters that parameterize the state and output equations. Hence,  $\theta$  includes intrinsic, extrinsic, forward, backward and lateral coupling strength. In (eq. 2),  $y$  represents the scalp EEG data, which is a function of the lead-field,  $L$  of a linear electromagnetic forward model and the averaged depolarization of the pyramidal cells in each source,  $x_0$ . Finally, a Gaussian error term  $\epsilon$  is included to account for noise.

$$\dot{x} = f(x, u, \theta) \text{ (eq. 1),}$$

$$y = L(\varphi)x_0 + \epsilon \text{ (eq. 2).}$$

Each source in the network is modelled as an equivalent current dipole. The locations and orientations of these are parametrized in  $\varphi$  in the electromagnetic forward model. Estimating the DCM is carried out using variational Bayesian inference (Friston *et al.*, 2007) using the Laplace approximation. The approximation to the posterior probability of the parameters,  $p(\theta|m, y)$  in (eq. 3) is carried out iteratively where the lower bound on the log-evidence  $\ln p(y|m)$  is maximized using a Newton search on the (negative) free energy  $F$ , see (eq. 4) where  $q(\theta) \approx p(\theta|y, m)$ .

$$p(\theta|y, m) \propto p(y|m, \theta)p(\theta|m) \text{ (eq. 3),}$$

$$F = \int q(\theta) \ln p(y, \theta) d\theta - \int q(\theta) \ln q(\theta) d\theta \text{ (eq. 4).}$$

$F$  is decomposed into an accuracy term describing how well the model fits the data (first term) and a complexity term describing how complex the model is (second term). Having established this, different models can be compared using the free energy, which takes into account how well the

model fits the data as well as how complex the model is. Hence, using the free energy in the comparison of models in principle protects against overfitting to the data using a highly complex model. Inference can be made at the level of model families instead of the individual models themselves (Penny *et al.*, 2010). In the comparison of families we used random effects (Penny *et al.*, 2010) which allows for the possibility that subjects use different cognitive strategies and brain networks. Exceedance probabilities, expressing how likely it is that a particular family is more likely than any of the other tested families, was used to compare families. Within the winning family, inference on the parameter level can be done using Bayesian model averaging (BMA). BMA weights the contribution of each model to the mean by its evidence (Penny *et al.*, 2010).

### DCM model specification

The network architecture of the roving MMN paradigm has been studied previously in healthy controls (Boly *et al.*, 2011; Garrido *et al.*, 2007, 2008, 2009b) using DCM, where the authors motivated the proposed models by previous results on MMN generators (Doeller *et al.*, 2003; Grau *et al.*, 2007; Opitz *et al.*, 2002; Rinne *et al.*, 2000). It is suggested that MMN generation include bilateral sources in the superior temporal gyrus (STG) and inferior frontal gyrus (IFG), with the IFG usually being most consistent in the right side. In order to model standard and deviant stimuli individually, we have also included bilateral primary auditory cortex (A1) as the first station of subcortical input.

Although the functional anatomy of MMN generation has been widely studied in healthy people it remains unknown in the 22q11.2 deletion carriers. In order to explore the network structure we therefore defined 16 models starting with a very parsimonious model comprising of bilateral A1 and STG with only forward connections. The remaining models were then built by adding hierarchical levels with increasing complexity until we had a full network comprising six sources: bilateral A1, STG and IFG (see Figure 2). Forward (F) and backward (B) connections were added at all levels of the hierarchy as well as lateral connections linking left and right STG, see Figure 2. With this model space we ensured that the three hypotheses of the underlying mechanisms of MMN were captured, namely the adaptation hypothesis, the model-adjustment hypothesis, and finally the predictive coding hypothesis (see (Garrido *et al.*, 2009a) for a review).

Since we hypothesized that the 22q11.2 deletion carriers would express less top-down predictions when compared to the healthy non-carriers, we divided the models into families according to their type of connection. An overview of the families can be seen in Figure 2, where the four families encompass **Forward only**; including models with forward connections only, **Forward backward**; including models with forward and backward connections, **Forward only I**; models with forward connections and lateral connections between bilateral STG. **Forward backward I**; models with forward and backward connections and lateral connections between bilateral STG.

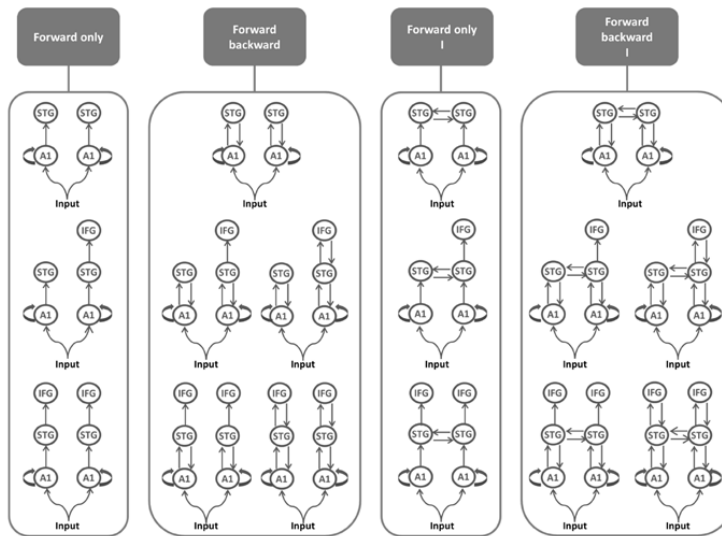

**Figure 2: The four DCM families tested.** Models are divided into families according to their type of connection; **Forward only** comprising models with forward connections, **Forward backward**: models with forward and backward connections, **Forward only I**: models with forward connections and lateral connections between bilateral STG. **Forward backward I**; models with forward and backward connections and lateral connections between bilateral STG.

## Statistical analysis

We used two sample t-test and Wilcoxon rank sum test to test for carrier-control differences in IQ and SIPS scores, respectively.

### Mismatch negativity responses

The peak for the extracted MMN waveforms was detected on the grand average difference waveform for the pooled group (22q11.2 carriers and controls). This peak was then used to extract individual MMN mean amplitude values ( $\pm 30$  ms around the peak) for each individual subject. Group differences in the MMN responses were assessed using a one-way ANCOVA with group as a factor (22q11.2 deletion carriers and controls) and age and sex as covariates. p-values are reported significant if  $p < 0.05$ .

### Spatio-temporal maps in sensor space

Spatio-temporal analysis was performed over the whole sensor-space (i.e. all electrodes) and time (-100 ms to 400 ms) using a full factorial 2x2 design with factors group (controls and 22q11.2DS) and condition (standard and deviant). Further, age and sex was included as covariates. With this approach we could do an unbiased assumption-free search for differences (main effects and interactions) over the entire sensor-time volume and use random field theory to correct for

multiple comparison testing (Kilner and Friston, 2010). All p values reported are thresholded using  $p=0.05$  FWE corrected at cluster level.

## DCM

Each of the 16 DCM models was fitted to each subject individually with the standard and deviant responses in the same model. The between trial effect was set to [0 1], meaning that the standard response is modelled as the baseline. In this way DCM can give differences in the connections that are necessary to fit the deviant responses. Random effects Bayesian model selection was performed in the pooled group (carriers and controls) to test the competing families in Figure 2. Within the family with highest exceedance probability, BMA was carried out. As mentioned, BMA is used to calculate the parameter estimates by weighting the contribution of each model to the mean by its evidence. In this way brittle assumptions about the model structure can be avoided.

Group differences in the parameters were assessed using a one-way ANCOVA with group as a factor (22q11.2 deletion carriers and controls) and age and sex as covariates.

Since 22q11.2DS is associated with hearing loss (Jiramongkolchai *et al.*, 2016) as well as lower levels of IQ (Vorstman *et al.*, 2015), we post-hoc correlated the results obtained on sensor level and the connectivity parameters from the DCM analysis with hearing thresholds obtained at 1000 Hz as well as IQ scores within the 22q11.2 group. Pearson correlation coefficient was used.

Further, we explored if the MMN amplitudes as well as connectivity parameters correlated with the expression of individual negative symptoms.

## Results

### Clinical scores

The 22q11.2DS group had IQ (median = 82.0, 90<sup>th</sup> percentile = 94.4, 10<sup>th</sup> percentile = 63.8) below the control group (median 108.0, 90<sup>th</sup> percentile = 127.0, 10<sup>th</sup> percentile = 95.2,  $t_{44}=-7.01$ ,  $p < 0.001$ ). The raw sum of negative symptoms in the 22q11.2 carriers ranged from 1-16 (mean = 6.7, SD = 3.7), from 0-12 for positive symptoms (mean = 2.7, SD = 3.1), from 0-6 for disorganized symptoms (mean = 1.7, SD = 1.8), and from 0-7 for generalized symptoms (mean = 0.9, SD = 1.9). None of the participants had psychosis but the 22q11.2DS group had significantly elevated SIPS scores for all four SIPS symptom domains; negative ( $W = 497.5$ ,  $p < 0.001$ ), positive ( $W = 376$ ,  $p = .004$ ), disorganized ( $W = 416.5$ ,  $p < 0.001$ ) and generalized ( $W = 324.5$ ,  $p=.037$ ) symptoms, relative to the control group, see also Table 1 for a summary of clinical and demographic data. Among the 22q11.2 deletion carriers, one was diagnosed with affective disorder, two with disturbance of activity/attention deficit disorder without hyperactivity, seven with anxiety or phobia and one with both autism spectrum disorder and anxiety or phobia. One of the 22q11.2 deletion carriers was taking 20 mg of retalin. Apart from this, no subject took medication acting on the central nervous system.

**Table 1.** Summary of group data for demographical and clinical data

Measures	Control group	22q11.2 group	Group statistics
Age	Mean 15.96 SD = 2.71	Mean 15.47 SD = 2.41	$t_{44} = -0.63, p = 0.53$
Sex	18 males / 9 females	13 males / 6 females	$\chi^2 = 0.54, p = 0.46$
IQ	Median = 108.0 90 <sup>th</sup> percentile = 127.0 10 <sup>th</sup> percentile = 95.2	Median = 82.0 90 <sup>th</sup> percentile = 94.4 10 <sup>th</sup> percentile = 63.8	$t_{44} = -7.01, p < 0.001$
<b>SIPS - subscales</b>			
Negative	Mean 0.59 SD = 1.04 Range 0-4	Mean 6.68 SD = 3.67 Range 1-16	$W = 477, p < 0.001$
Positive	Mean 0.81 SD = 1.49 Range 0-6	Mean 2.74 SD = 3.07 Range 0-12	$W = 305.5, p = 0.008$
Disorganized	Mean 0.11 SD = 0.42 Range 0-2	Mean 1.68 SD = 1.83 Range 0-6	$W = 404, p < 0.001$
Generalized	Mean 0.15 SD = 0.46 Range 0-2	Mean 0.95 SD = 1.90 Range 0-7	$W = 312.5, p = 0.027$

### Mismatch negativity responses

Figure 3A, B and E shows the grand average data for the conventional MMN analysis. Responses to the standard were subtracted from the response to the deviant (D). This was done for the first standard (S1) up until the fifth standard (S5) in order to estimate which standard tone would produce the highest MMN response in the pooled group. The mean amplitude values of the MMN responses as a function of tone repetition followed the shape of a parabola (see Figure 3A) for the pooled group, i.e., averaged across both the carriers and control. This indicates that surprise builds up until S3, after which it decreases, possibly because a change starts to be expected. Given that S3 produces the highest MMN in the pooled group, S3 was used as the standard for subsequent analysis. Figure 3B shows the mean amplitude and the standard error for the MMN responses as a function of tone repetition separately for the two groups. Tone S3 (or standard), deviant tone, and MMN responses for both groups can be seen in Figure 3C, D and E, respectively. Differences in mean MMN amplitudes between 22q11.2 and controls failed to reach significance ( $F_{1,41} = 0.584, p = 0.449$ ). No effect of the covariates sex ( $F_{1,41} = 0.005, p = 0.946$ ) or age ( $F_{1,41} = 1.480, p = 0.231$ ) was observed.

The post-hoc correlation of MMN amplitudes in the 22q11.2DS group with hearing levels and IQ revealed no correlation with hearing ( $\rho = 0.24, p = 0.335$ ) levels but a significant correlation with IQ ( $\rho = 0.65, p = 0.004$ ). There was no significant correlation between the MMN amplitudes and the sum of total negative symptoms.

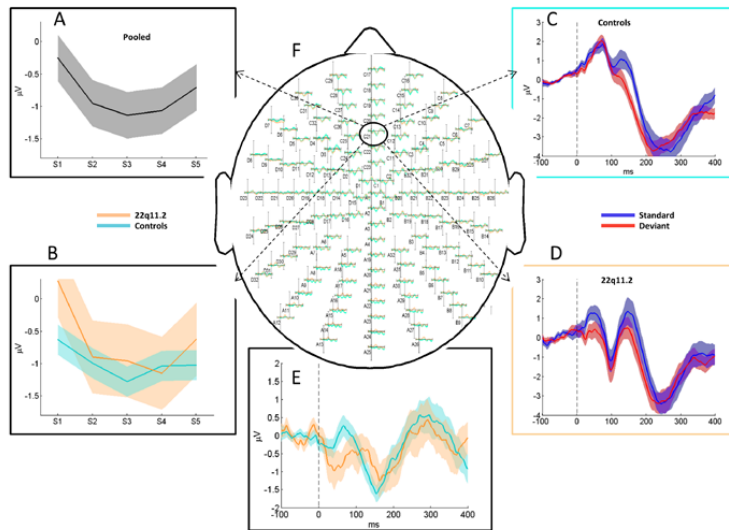

**Figure 3: Grand average responses obtained in the roving paradigm.** A) Mean amplitude around peak MMN in a window of  $\pm 30$ ms as a function of standards in the roving paradigm. Note only up until 5 standards are shown since the following standards (S6, S7 and S8) contained less than 100 trials. The standard (S3) is selected according to the criteria; highest (most negative) MMN in the pooled group with at least 100 trials. B) Same as in A), just shown separately for each group (carriers in orange and controls in cyan) C) The response to S3 in blue and deviant D in red for the control group. D) The response to S3 in blue and deviant D in red for the carriers. The shaded area around the curve illustrates one standard error of the mean. E) The MMN waveform for controls (turquoise) and 22q11.2 (orange) using the third tone as the standard (S3). F) Channel locations on the scalp, Fz is marked with a black ellipse which is used for all subfigures.

### Spatiotemporal maps in sensor space

Statistical parametric mapping was employed to run a full factorial 2x2 ANCOVA design with factors group (22q11.2 deletion carriers and healthy controls) and condition (standard and deviant), and age and sex as covariates. We found a significant main effect of group (see Figure 4) peaking at 90 ms ( $F_{1,84}=20.21$ ,  $p = 0.001$ , FWE corrected at the cluster level) in the fronto-central areas. This effect was driven by a more negative N1 component in the 22q11.2 deletion carriers (see Figure 3C and D), indicative of a failure to suppress responses to repeated stimuli in carriers compared to controls. No main effect of condition (standard and deviant) or group by condition interaction effect was observed at the reported corrected threshold. Post-hoc analysis within the 22q11.2DS group revealed no correlation with hearing thresholds. There was a correlation between the EEG responses and IQ, similar for the MMN amplitudes, seen in the left side at the



fronto-temporal electrodes at time 80ms, an area and time different from the group effect observed in Figure 4.

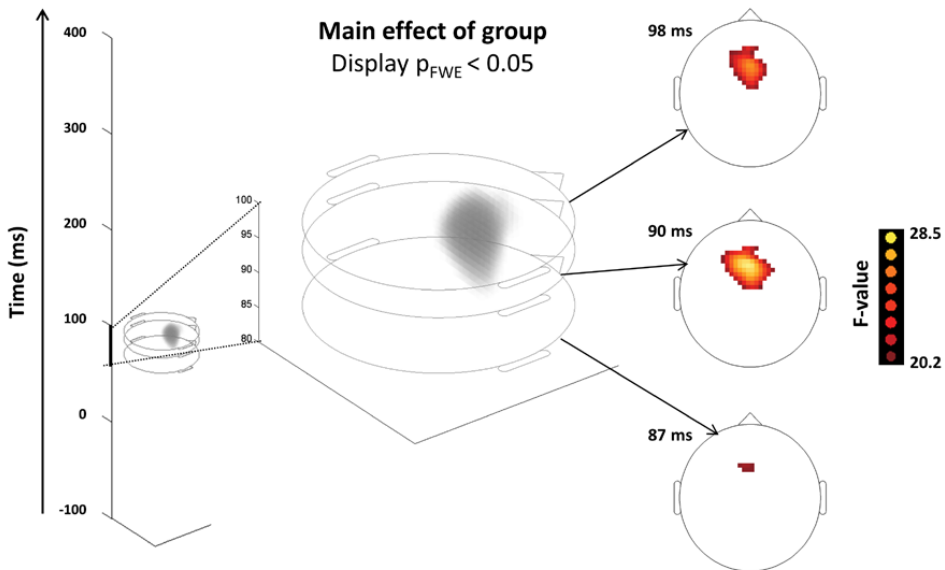

**Figure 4: Statistical t-maps showing results from the full factorial design.** Main effect of group ( $p=0.05$  FWE corrected) over the entire scalp and time. There is a significant cluster in the fronto-central area peaking at 90 ms.

## DCM

Figure 5 shows model exceedance probabilities using random effects Bayesian model selection for the four families of models. The family with both forward and backward connections as well as lateral connections linking bilateral STG had the greatest exceedance probability. BMA within the family with highest exceedance probability was carried out and each connection within the network (12 connections) was tested for differences between 22q11.2 carriers and controls. The intrinsic connection within right A1 was reduced in 22q11.2 relative to controls ( $F_{1,41} = 5.443$ ,  $p = 0.025$ ). This finding suggests decreased adaptation within right A1 for carriers, and adds to the notion of failure to suppress responses to repeated stimuli as revealed by greater N1 responses (at the scalp level) for carriers compared to controls. In addition, we found reduced extrinsic connection from right IFG to STG ( $F_{1,41} = 4.280$ ,  $p = 0.045$ ) in the carriers compared to controls, which suggests a disruption of top-down processes, or predictive processes in the 22q11.2. No effect of age was observed for either of the two connections ( $F_{1,41} = 0.012$ ,  $p = 0.915$  for intrinsic connection,  $F_{1,41} < 0.001$ ,  $p = 0.984$  for backward connection). We did not find an effect of sex on the intrinsic connection ( $F_{1,41} = 0.263$ ,  $p = 0.811$ ). However, we found that males had a reduced modulation of the backward connection ( $F_{1,41} = 4.396$ ,  $p = 0.042$ ) compared to females. While

these effects are suggestive, they did not survive correction for multiple comparisons using a conservative Bonferroni correction for 12 tests.

Post-hoc correlations within the 22q11.2DS group of the two connections that differed between groups revealed no correlation with observed hearing thresholds and IQ (all  $p > 0.05$ ). There was no correlation between the two connections and the total sum of negative symptoms in the 22q11.2 carriers. Further, BMA analysis across the whole model space without model selection did not reveal group difference in the connectivity parameters.

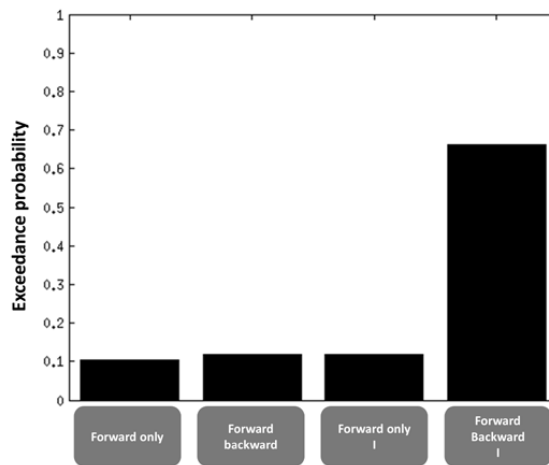

**Figure 5: Model exceedance probabilities for the four families.** Model family names correspond to the ones in Figure 2. The sum of the exceedance probabilities equals one. The family including models with forward, backward and lateral connections has the highest exceedance probability.

## Discussion

In this study, we investigated the responses elicited by a roving auditory MMN paradigm in a group of young 22q11.2 deletion carriers. While we found no indication of group differences between the MMN responses per se, the spatiotemporal analysis of responses to tones (standards and deviants) revealed a main effect of group in the fronto-central areas peaking at 90ms. This group difference was due to the 22q11.2 deletion carriers exhibiting larger negative responses at the N1 component, which suggests a failure to suppress neuronal responses to repeated stimuli. The dynamic interactions of the network structures underlying MMN were investigated with DCM and pointed to effective connectivity reductions in the backward connection linking right IFG and STG, as well as the intrinsic connection within right A1. The reduction in top-down connectivity suggest a disruption in predictive processes in 22q11.2, which is in keeping with the dysconnection hypothesis of schizophrenia (Friston *et al.*, 2016). In addition, reduced modulation within right A1 together with a greater N1 component in 22q11.2, suggests reduced adaptation, or a failure to suppress responses to repeated stimuli.

The fact that the 22q11.2 deletion carriers in the present study show a mismatch negativity response at the scalp level suggests that the change detection system is still functioning in this group. The results are in line with previous studies (Baker *et al.*, 2005; Zarchi *et al.*, 2013), where authors also report MMN responses in 22q11.2 deletion carriers and controls but no significant difference in the amplitude of frequency MMN between the two groups. However, Baker and colleagues (Baker *et al.*, 2005) found reduced duration MMN in a 22q11.2 sample which suggests that the system for generating MMN responses in 22q11.2 can be activated but is not functioning optimally. Although (Zarchi *et al.*, 2013) failed to find significant differences in the MMN responses to frequency, intensity, directionality, and duration deviants between groups, they did find that gap-MMN amplitudes were associated with increased severity of negative symptoms and reductions in executive functions in the 22q11.2 sample.

We found group differences in the responses to tones at fronto-central electrodes at 90 ms. The timing of this effect fell within the usual time window of the N1 component. The effect was driven by responses that were greater (or more negative) for the 22q11.2 deletion carriers as compared to the controls. This is in line with what Rihs and colleagues (Rihs *et al.*, 2013) found in a 22q11.2 cohort whereby an enhanced N1 component was explained by a greater activation in the medial frontal cortex and the dorsal anterior cingulate. The N1 component has previously been found to be reduced in schizophrenia, as well as in first episode and first-degree relatives (Foxye *et al.*, 2011; Umbricht *et al.*, 2003). However, several studies have also failed to show this reduction, see (Rosburg *et al.*, 2008) for a review. Different factors such as inter stimulus interval, medication and attention play a crucial role in the results of the N1 findings in schizophrenia (Rosburg *et al.*, 2008) which might explain why results are not always consistent.

A failure to adapt to repeated (or learnt) stimuli could also explain the observed N1 enhancement in 22q11.2. It is important to remember that, in this study, the standards and deviants have the exact same physical properties and so differences in brain responses evoked by these conditions can only be due to context. It has been suggested that psychosis is a state of aberrant salience, whereby common events have enhanced salience (Kapur, 2003; Roiser *et al.*, 2009, 2013). The lack of N1 adaptation in the 22q11.2 deletion carriers, suggests that the salience in standards and deviants is likely to be perceived the same. In other words, standards and deviants might be equally surprising. Importantly, the 22q11.2 deletion carriers included in the present study did not have any signs of psychosis, which points to the promising possibility of using such ERP signals as potential early biomarkers for schizophrenia that arise prior to disease onset. While this finding is promising and exciting, further work is required to corroborate this idea, potentially in a follow-up longitudinal study.

Results pointed towards group differences in the effective connectivity in the backward connection from IFG to STG in the right hemisphere as well as the intrinsic connection in right A1, where the 22q11.2DS for both connections show a reduced modulation between standards and deviants as compared to the controls. Critically, differences within these two connections have been previously found in patients with schizophrenia (Dima *et al.*, 2012), although they found a stronger modulation within the schizophrenia group for the backward connection from right IFG to right STG compared to the control group. According to theoretical accounts of predictive coding,

the forward or bottom-up connections convey information about the incoming stimuli and how well it matches expectations based on a learnt context (Friston, 2003). Expectations or predictions, on the other hand, are conveyed by top-down or backward connections. In light of this theory, we speculate that controls are able to efficiently send down predictions indicated by the positive modulation from right IFG to right STG. This modulation was reversed for the 22q11.2 carriers which suggest that this process is somehow reduced. However, caution is need in interpreting these findings as these effects did not survive Bonferroni correction for multiple comparisons. A follow-up study including a larger cohort would be needed to draw a more definite conclusion. Previous studies investigating differences in connectivity between schizophrenia and healthy controls have shown that people with schizophrenia exhibit disrupted connectivity especially within the backward connections (Adams *et al.*, 2013; Dima *et al.*, 2010; Fogelson *et al.*, 2014). The reduction of backward connections and thereby reduced ability to pass down predictions in the 22q11.2 deletion carriers is therefore consistent with findings reported in the schizophrenia literature.

In summary, we show that young non-psychotic 22q11.2 deletion carriers show a failure to suppress neuronal responses, or adapt, to repeated stimuli, as well as a trend towards a reduced ability to pass predictions down the hierarchy. We suggest that such deficits, also found in schizophrenia, may be already apparent prior to illness onset.

## **Acknowledgements**

We would like to thanks all the participants and their families for taking the time to participate in this study. We would like to thanks all the participant and families for taking the time to participate in our study and the Danish National 22q11DS Association for their strong support of our work. We would also like to express our gratitude to the staff involved in the Danish Blood Donor Study, Capital Region Blood bank, Glostrup. Further, we would like to thank <http://www.forsogsperson.dk> from which our control subjects were recruited from. M.I.G acknowledges support from any Australian Research Council Discovery Early Career Researcher Award (DE130101393) and a University of Queensland Fellowship (2016000071).

## **Funding**

This study was funded by the Lundbeck Foundation, Denmark (R155-2014-1724); Lundbeck Foundation [Grant of Excellence “ContAct” R59 A5399]; Lundbeck Foundation fellowship (R105-9813); The Capital Region's Research Foundation for Mental Health Research.

H.R.S. received honoraria as speaker from Lundbeck A/S, Valby, Denmark, Biogen Idec, Denmark A/S, Genzyme, Denmark and MerckSerono, Denmark, honoraria as editor from Elsevier Publishers, Amsterdam, The Netherlands and Springer Publishing, Stuttgart, Germany, travel support from MagVenture, Denmark, and grant support from Biogen Idec, Denmark A/S. M.R.B is a prior employee at H. Lundbeck A/S, Denmark and received financial support for her PhD from the Innovation Fund Denmark. M.D is employed with Lundbeck A/S. The authors declare no further biomedical financial interests or potential conflicts of interest.

This article is distributed under the Danish legislation governed by the Privacy Act (act# 429, 31/05/2000), which does not permit data sharing at publicly available repositories or in raw formats. Summary statistics can be obtained through contact with the corresponding author (melissal@drcmr.dk).

## References

- Adams RA, Stephan KE, Brown HR, Frith CD, Friston KJ. The computational anatomy of psychosis. *Front. psychiatry* 2013; 4: 47.
- Atkinson RJ, Michie PT, Schall U. Duration mismatch negativity and P3a in first-episode psychosis and individuals at ultra-high risk of psychosis. *Biol. Psychiatry* 2012; 71: 98–104.
- Baker K, Baldeweg T, Sivagnanasundaram S, Scambler P, Skuse D. COMT Val108/158Met modifies mismatch negativity and cognitive function in 22q11 deletion syndrome. *Biol. Psychiatry* 2005; 58: 23–31.
- Baldeweg T, Klugman A, Gruzelier JH, Hirsch SR. Impairment in frontal but not temporal components of mismatch negativity in schizophrenia. *Int. J. Psychophysiol.* 2002; 43: 111–22.
- Bassett AS, Marshall CR, Lionel AC, Chow EWC, Scherer SW. Copy number variations and risk for schizophrenia in 22q11.2 deletion syndrome. *Hum. Mol. Genet.* 2008; 17: 4045–53.
- Bodatsch M, Brockhaus-Dumke A, Klosterkötter J, Ruhrmann S. Forecasting psychosis by event-related potentials-systematic review and specific meta-analysis. *Biol. Psychiatry* 2015; 77: 951–8.
- Boly M, Garrido MI, Gosseries O, Bruno M -a., Boveroux P, Schnakers C, et al. Preserved Feedforward But Impaired Top-Down Processes in the Vegetative State. *Science* (80-. ). 2011; 332: 858–862.
- Catts S V, Shelley AM, Ward PB, Liebert B, McConaghy N, Andrews S, et al. Brain potential evidence for an auditory sensory memory deficit in schizophrenia. *Am. J. Psychiatry* 1995; 152: 213–9.
- David O, Kiebel SJ, Harrison LM, Mattout J, Kilner JM, Friston KJ. Dynamic causal modeling of evoked responses in EEG and MEG. *Neuroimage* 2006; 30: 1255–1272.
- Delorme A, Makeig S. EEGLAB: an open source toolbox for analysis of single-trial EEG dynamics including independent component analysis. *J. Neurosci. Methods* 2004; 134: 9–21.
- Dima D, Dietrich DE, Dillo W, Emrich HM. Impaired top-down processes in schizophrenia: A DCM study of ERPs. *Neuroimage* 2010; 52: 824–832.
- Dima D, Frangou S, Burge L, Braeutigam S, James AC. Abnormal intrinsic and extrinsic connectivity within the magnetic mismatch negativity brain network in schizophrenia: A preliminary study. *Schizophr. Res.* 2012; 135: 23–27.
- Doeller CFC, Opitz B, Mecklinger A, Krick C, Reith W, Schröger E. Prefrontal cortex involvement in preattentive auditory deviance detection: Neuroimaging and electrophysiological evidence. *Neuroimage* 2003; 20: 1270–1282.
- Fogelson N, Litvak V, Peled A, Fernandez-del-Olmo M, Friston K. The functional anatomy of schizophrenia: A dynamic causal modeling study of predictive coding. *Schizophr. Res.* 2014; 158: 204–212.
- Foxe JJ, Yeap S, Snyder AC, Kelly SP, Thakore JH, Molholm S. The N1 auditory evoked potential component as an endophenotype for schizophrenia: high-density electrical mapping in clinically unaffected first-degree relatives, first-episode, and chronic schizophrenia patients. *Eur. Arch. Psychiatry Clin. Neurosci.* 2011; 261: 331–9.
- Friston K. Learning and inference in the brain. *Neural Networks* 2003; 16: 1325–1352.

Friston K, Brown HR, Siemerkus J, Stephan KE. The dysconnection hypothesis (2016). *Schizophr. Res.* 2016; 176: 83–94.

Friston K, Mattout J, Trujillo-Barreto N. Variational free energy and the Laplace approximation. *Neuroimage* 2007; 34: 220–234.

Friston KJ. The disconnection hypothesis. *Schizophr. Res.* 1998; 30: 115–125.

Friston KJ, Harrison L, Penny W. Dynamic causal modelling. *Neuroimage* 2003; 19: 1273–1302.

Garrido MI, Friston KJ, Kiebel SJ, Stephan KE, Baldeweg T, Kilner JM. The functional anatomy of the MMN: A DCM study of the roving paradigm. *Neuroimage* 2008; 42: 936–944.

Garrido MI, Kilner JM, Kiebel SJ, Friston KJ. Evoked brain responses are generated by feedback loops. *Proc. Natl. Acad. Sci. U. S. A.* 2007; 104: 20961–20966.

Garrido MI, Kilner JM, Stephan KE, Friston KJ. The mismatch negativity: A review of underlying mechanisms. *Clin. Neurophysiol.* 2009a; 120: 453–463.

Garrido MI, Kilner J, Kiebel S, Friston K. Dynamic causal modeling of the response to frequency deviants. *J. Neurophysiol.* 2009b; 101: 2620–2631.

Goodship J, Cross I, Liling J, Wren C. A population study of chromosome 22q11 deletions in infancy. *Arch. Dis. Child.* 1998; 79: 348–51.

Grau C, Fuentemilla L, Marco-Pallares J. Functional neural dynamics underlying auditory event-related N1 and N1 suppression response. *Neuroimage* 2007; 36: 522–531.

Hsieh MH, Shan J-C, Huang W-L, Cheng W-C, Chiu M-J, Jaw F-S, et al. Auditory event-related potential of subjects with suspected pre-psychotic state and first-episode psychosis. *Schizophr. Res.* 2012; 140: 243–9.

Jansen BH, Rit VG. Electroencephalogram and visual evoked potential generation in a mathematical model of coupled cortical columns. *Biol. Cybern.* 1995; 73: 357–366.

Jessen F, Fries T, Kucharski C, Nishimura T, Hoenig K, Maier W, et al. Amplitude reduction of the mismatch negativity in first-degree relatives of patients with schizophrenia. 2001.

Jiramongkolchai P, Kumar MS, Chinnadurai S, Wootten CT, Goudy SL. Prevalence of hearing loss in children with 22q11.2 deletion syndrome. *Int. J. Pediatr. Otorhinolaryngol.* 2016; 87: 130–133.

Kapur S. Psychosis as a state of aberrant salience: a framework linking biology, phenomenology, and pharmacology in schizophrenia. *Am. J. Psychiatry* 2003; 160: 13–23.

Karayiorgou M, Simon TJ, Gogos J a. 22q11.2 microdeletions: linking DNA structural variation to brain dysfunction and schizophrenia. *Nat. Rev. Neurosci.* 2010; 11: 402–416.

Kilner J, Friston K. Topological inference for EEG and MEG. *Ann. Appl. Stat.* 2010; 4: 1272–1290.

Larsen TK, Melle I, Auestad B, Haahr U, Joa I, Johannessen JO, et al. Early detection of psychosis: positive effects on 5-year outcome. *Psychol. Med.* 2010; 41: 1461–1469.

McGlashan TH, Miller TJ, Woods SW, Rosen JL, Hoffmann RE, Davidson L. Structured Interview for Prodromal Syndromes (SIPS). Norsk version 5.0. Stavanger Universitetssjukehus, Norge; 2012.

Michie PT. What has MMN revealed about the auditory system in schizophrenia? *Int. J. Psychophysiol.* 2001; 42: 177–194.

Michie PT, Innes-Brown H, Todd J, Jablensky A V. Duration mismatch negativity in biological

relatives of patients with schizophrenia spectrum disorders. *Biol. Psychiatry* 2002; 52: 749–758.

Miller TJ, McGlashan TH, Rosen JL, Cadenhead K, Cannon T, Ventura J, et al. Prodromal assessment with the structured interview for prodromal syndromes and the scale of prodromal symptoms: predictive validity, interrater reliability, and training to reliability. *Schizophr. Bull.* 2003; 29: 703–15.

Näätänen R. The Mismatch Negativity. *Ear Hear.* 1995; 16: 6–18.

Näätänen R, Kähkönen S. Central auditory dysfunction in schizophrenia as revealed by the mismatch negativity (MMN) and its magnetic equivalent MMNm: a review. *Int. J. Neuropsychopharmacol.* 2009; 12: 125–135.

Näätänen R, Paavilainen P, Rinne T, Alho K. The mismatch negativity (MMN) in basic research of central auditory processing: A review. *Clin. Neurophysiol.* 2007; 118: 2544–2590.

Opitz B, Rinne T, Mecklinger A, von Cramon DY, Schröger E. Differential contribution of frontal and temporal cortices to auditory change detection: fMRI and ERP results. *Neuroimage* 2002; 15: 167–174.

Oskarsdóttir S, Vujic M, Fasth A. Incidence and prevalence of the 22q11 deletion syndrome: a population-based study in Western Sweden. *Arch. Dis. Child.* 2004; 89: 148–51.

Penny WD, Stephan KE, Daunizeau J, Rosa MJ, Friston KJ, Schofield TM, et al. Comparing families of dynamic causal models. *PLoS Comput. Biol.* 2010; 6: e1000709.

Purcell SM, Wray NR, Stone JL, Visscher PM, O'Donovan MC, Sullivan PF, et al. Common polygenic variation contributes to risk of schizophrenia and bipolar disorder. *Nature* 2009; 460: 748–52.

Ranlund S, Adams RA, Díez Á, Constante M, Dutt A, Hall M-H, et al. Impaired prefrontal synaptic gain in people with psychosis and their relatives during the mismatch negativity. *Hum. Brain Mapp.* 2016; 37: 351–65.

Rao RP, Ballard DH. Predictive coding in the visual cortex: a functional interpretation of some extra-classical receptive-field effects. *Nat. Neurosci.* 1999; 2: 79–87.

Reynolds CR, Kamphaus RW. Reynolds Intellectual Assessment Scales (RIAS), Reynolds Intellectual Screening Test (RIST). Dansk version - Vejledning. Hogrefe Psykologisk Forlag. København, Danmark; 2011.

Rihs T a, Tomescu MI, Britz J, Rochas V, Custo A, Schneider M, et al. Altered auditory processing in frontal and left temporal cortex in 22q11.2 deletion syndrome: a group at high genetic risk for schizophrenia. *Psychiatry Res.* 2013; 212: 141–9.

Rinne T, Alho K, Ilmoniemi R, Virtanen J, Näätänen R. Separate time behaviors of the temporal and frontal mismatch negativity sources. *Neuroimage* 2000; 12: 14–19.

Robert J. Shprintzen. Management of genetic syndromes. In: Cassidy, S., & Allanson JE, editor(s). . New York: Hoboken, N.J.: J. Wiley; 2005. p. 615–32.

Robin NH, Shprintzen RJ. Defining the clinical spectrum of deletion 22q11.2. *J. Pediatr.* 2005; 147: 90–6.

Roiser JP, Howes OD, Chaddock CA, Joyce EM, McGuire P. Neural and behavioral correlates of aberrant salience in individuals at risk for psychosis. *Schizophr. Bull.* 2013; 39: 1328–36.

Roiser JP, Stephan KE, den Ouden HEM, Barnes TRE, Friston KJ, Joyce EM. Do patients with



schizophrenia exhibit aberrant salience? *Psychol. Med.* 2009; 39: 199–209.

Rosburg T, Boutros NN, Ford JM. Reduced auditory evoked potential component N100 in schizophrenia—a critical review. *Psychiatry Res.* 2008; 161: 259–74.

Rutter M, Bailey A, Berument SK, Lord C, Pickles A. The Social Communication Questionnaire (SCQ). Dansk version - Vurdering Livsforløb. Hogrefe Psykologisk Forlag. København, Danmark; 2005.

Rutter M, Bailey A, Lord C. The Social Communication Questionnaire (SCQ). Manual. (Form: Lifetime). Western Psychological Services. Los Angeles, CA; 2003.

Schneider M, Debbané M, Bassett AS, Chow EWC, Fung WLA, van den Bree M, et al. Psychiatric disorders from childhood to adulthood in 22q11.2 deletion syndrome: results from the International Consortium on Brain and Behavior in 22q11.2 Deletion Syndrome. *Am. J. Psychiatry* 2014; 171: 627–39.

Sheehan D, Shytle, K. Milo, J. Janavs YL. M.I.N.I. International Neuropsychiatric Interview For Children and Adolescents (M.I.N.I.-kid). Dansk version 6.0. Dansk Version 6.0 2013; 2013.

Sheehan D V., Lecrubier Y, Sheehan KH, Amorim P, Janavs J, Weiller E, et al. The Mini-International Neuropsychiatric Interview (M.I.N.I.): The development and validation of a structured diagnostic psychiatric interview for DSM-IV and ICD-10. In: *Journal of Clinical Psychiatry*. 1998. p. 22-33-57.

Stefansson H, Rujescu D, Cichon S. Large recurrent microdeletions associated with schizophrenia. *Nature* 2008; 455: 232–236.

Umbricht D, Koller R, Schmid L, Skrabo A, Grübel C, Huber T, et al. How specific are deficits in mismatch negativity generation to schizophrenia? *Biol. Psychiatry* 2003; 53: 1120–31.

Umbricht D, Krljesb S. Mismatch negativity in schizophrenia: A meta-analysis. *Schizophr. Res.* 2005; 76: 1–23.

Vangkilde A, Olsen L, Hoeffding LK, Pedersen CB, Mortensen PB, Werge T, et al. Schizophrenia Spectrum Disorders in a Danish 22q11.2 Deletion Syndrome Cohort Compared to the Total Danish Population—A Nationwide Register Study. *Schizophr. Bull.* 2016; 42: 824–831.

Vorstman JAS, Breetvelt EJ, Duijff SN, Eliez S, Schneider M, Jalbrzikowski M, et al. Cognitive decline preceding the onset of psychosis in patients with 22q11.2 deletion syndrome. *JAMA psychiatry* 2015; 72: 377–85.

Zarchi O, Carmel M, Avni C, Attias J, Frisch A, Michaelovsky E, et al. Schizophrenia-like neurophysiological abnormalities in 22q11.2 deletion syndrome and their association to COMT and PRODH genotypes. *J. Psychiatr. Res.* 2013; 47: 1623–9.

APPENDIX B

Reduced repetition  
suppression in 22q11.2  
deletion syndrome

---

## Reduced repetition suppression in 22q11.2 deletion syndrome

Kit Melissa Larsen <sup>a,b,c,d</sup>, Morten Mørup <sup>b</sup>, Marta I. Garrido <sup>h,i,j,k</sup>, Michelle Rosgaard Birknow <sup>c,d,e</sup>,  
Elvira Fischer <sup>a</sup>, Line Olsen <sup>c,d</sup>, Michael Didriksen <sup>e</sup>, William Frans Christiaan Baaré <sup>a</sup>, Thomas  
Werge <sup>c,d,f</sup>, Hartwig Siebner <sup>a,f,g</sup>.

<sup>a</sup> Danish Research Centre for Magnetic Resonance, Centre for Functional and Diagnostic Imaging and Research, Copenhagen University Hospital Hvidovre, Hvidovre, Denmark

<sup>b</sup> DTU Compute, Cognitive Systems, Technical University of Denmark, Lyngby, Denmark

<sup>c</sup> Institute of Biological Psychiatry, Mental Health Centre Sct. Hans, Copenhagen University Hospital, Boserupvej 2, DK-4000 Roskilde, Denmark

<sup>d</sup> iPSYCH, The Lundbeck Foundation Initiative for Integrative Psychiatric Research, Aarhus and Copenhagen, Denmark

<sup>e</sup> Synaptic Transmission, H. Lundbeck A/S, Ottiliavej 9, DK-2500 Valby, Denmark

<sup>f</sup> Department of Clinical Medicine, Faculty of Health and Medical Sciences, University of Copenhagen, Copenhagen, Denmark

<sup>g</sup> Department of Neurology, Copenhagen University Hospital Bispebjerg, Copenhagen, Denmark

<sup>h</sup> Queensland Brain Institute, The University of Queensland, St Lucia 4072, Brisbane, Australia

<sup>i</sup> Centre for Advanced Imaging, The University of Queensland, St Lucia 4072, Brisbane, Australia

<sup>j</sup> Australian Research Council Centre of Excellence for Integrative Brain Function Centre of Excellence for Integrative Brain Function, The University of Queensland, St Lucia 4072, Brisbane, Australia

<sup>k</sup> School of Mathematics and Physics, The University of Queensland, St Lucia 4072, Brisbane, Australia

## **Abstract**

Early risk markers for schizophrenia are highly desirable since results on early disease diagnosis and early treatment have shown positive effect on clinical outcomes and everyday functioning in patients. One of the most common copy number variants, the 22q11.2 deletion syndrome, confers a markedly increased risk for schizophrenia. Therefore, the 22q11.2DS is a homogeneous genetic liability model which enables studies that intent to identify functional abnormalities that may precede disease onset. Recent results have shown evidence that repetition suppression, i.e., responses to repeated stimuli, can be interpreted in the framework of predictive coding as a failure to suppress prediction errors. A process requiring bottom-up and top-down processing. Here, we investigated repetition-dependent changes in effective connectivity underlying repeated auditory stimuli. We recorded high-density EEG from 19 22q11.2 deletion carriers in the age range of 12-25 years, as well as from 27 healthy non-carriers with comparable age and sex distribution, while they listened to a sequence of sounds arranged in a roving oddball paradigm. Using dynamic causal modelling results indicate that repetition-dependent changes are parametrically modulated by a u-shaped function. Further, 22q11.2 deletion carriers showed a trend for increased forward connectivity. Scalp data showed that 22q11.2 deletion carriers failed to adapt to the repeated stimuli as shown by enhanced N1 amplitudes. Further, reduced responses in the N2 component were observed in 22q11.2 deletion carriers compared to controls. In summary, our findings suggest that 22q11.2 deletion carriers have reduced repetition suppression, which might be associated with an increased forward connectivity.

**Keywords:** 22q11 Deletion Syndrome, Dynamic causal modelling, EEG, Mismatch negativity, repetition suppression

**Abbreviations:** DCM = Dynamic Causal Modelling, MMN = Mismatch Negativity, 22q11.2DS = 22q11.2 Deletion Syndrome

## Introduction

22q11.2 deletion syndrome (22q11.2DS) is one of the most common copy number variants in humans and has a prevalence of 1:2000 to 1:4000 (Goodship *et al.*, 1998; Oskarsdóttir *et al.*, 2004; Shprintzen, 2005). The syndrome is associated with a high frequency of several neurodevelopmental disorders, including autism, ADHD and schizophrenia (Bassett *et al.*, 2008; Karayiorgou *et al.*, 2010; Purcell *et al.*, 2009; Schneider *et al.*, 2014; Stefansson *et al.*, 2008). The 22q11.2DS is clinically presented with a highly variable phenotype, including a range of somatic disorders, learning problems, cognitive deficits (Karayiorgou *et al.*, 2010; Robin and Shprintzen, 2005), and hearing problems (Jiramongkolchai *et al.*, 2016). The prevalence of schizophrenia-spectrum disorder is 24% in adolescent and 41% in adult 22q11.2 deletion carriers (Schneider *et al.*, 2014). A recent nationwide Danish Registry study showed that the risk of developing a schizophrenia-spectrum disorder in individuals previously diagnosed with 22q11.2DS was approximately eight times higher than in the general population (Vangkilde *et al.*, 2016). Carriers of 22q11.2DS therefore offer the possibility to study functional abnormalities that precede clinical onset of schizophrenia and therefore to reveal important insight into the pathogenesis of the disease.

The ability to adapt to the environment and react to deviation within it is something the normal brain masters on a daily basis. However, patients with schizophrenia show reduced ability to adapt to the environment expressed as a state of aberrant salience (Kapur, 2003) via a loss of precise top-down predictions (Adams *et al.*, 2013). An example of this are the typically reduced neural responses to repeated stimuli as a function of number of repetitions a process called repetition suppression, which is often depicted as a consequence of neural fatigue (Grill-Spector *et al.*, 2006). Recent evidence, however, suggests that repetition suppression may be caused by sensory predictions (Baldeweg, 2007; Summerfield *et al.*, 2008; Todorovic *et al.*, 2011; Todorovic and de Lange, 2012). Repetition suppression can therefore be interpreted in the framework of predictive coding (Auksztulewicz and Friston, 2016; Friston, 2005), where the brain is seen as a device constantly making inference and predictions about future events. From this perspective repetition suppression is a consequence of minimizing prediction errors by constantly adapting to the environment through changes in predictions about the sensory inputs. It has been shown that repetition-dependent changes in responses to repeated stimuli are due to experience-dependent changes in effective connectivity (Garrido *et al.*, 2009a). Repetition suppression has shown to be reduced in schizophrenia and in people at clinically high risk for schizophrenia (Gonzalez-Heydrich *et al.*, 2016), as expressed in a reduction of N1 adaptation, that is a larger N1 component. Further, decreased amplitudes to mismatch negativity (MMN) responses are consistently found in patients with schizophrenia (Catts *et al.*, 1995; Michie, 2001; Näätänen and Kähkönen, 2009; Umbricht and Krljesb, 2005), which is likely to reflect a reduced ability to learn and adapt to a changing environment. MMN is elicited in oddball paradigms where an established rule in a statistical

regular environment is violated. According to hierarchical inference or predictive coding (Friston, 2003; Rao and Ballard, 1999) MMN is a failure to suppress prediction errors (Garrido, *et al.*, 2009b). MMN can also be elicited in roving paradigms that besides from studying MMN per se, gives the unique possibility to study responses to repeated tone, where oddballs, or deviants, eventually become a standard due to repetition.

Only a limited number of studies on N1 amplitudes and MMN responses in 22q11.2DS have previously been reported. N1 amplitudes have been reported to be enhanced in 22q11.2DS (Larsen *et al.*, 2017 *in prep*; Rihs *et al.*, 2013), whereas duration MMN has been found to be reduced (Baker *et al.*, 2005). However, (Zarchi *et al.*, 2013) and (Larsen *et al.*, 2017, *in prep*) failed to show reduced MMN amplitudes in 22q11.2DS. It should though be noted that (Larsen *et al.*, 2017, *in prep*) only studied frequency MMN whereas (Zarchi *et al.*, 2013) studied frequency, intensity, directionality, duration and a silent gap deviants. To our knowledge, there is no study focusing on repetition suppression in 22q11.2DS, which is relevant to study since this has been found to be reduced in schizophrenia.

Here we employ a parametric DCM approach using the roving MMN paradigm from (Larsen *et al.*, 2017, *in prep*), to study connectivity changes underpinning repeated auditory stimuli in 22q11.2 deletion carriers. We hypothesized that responses to repeated stimuli would show a parametric modulation with decreasing connectivity within the first repetitions, followed by an increase reflecting the prediction of new stimuli, in accordance with the predictive coding theory. We test this by introducing three different effects; u-shaped, which is in accordance with predictive coding; decaying exponential, which accounts for effects due to habituation or adaptation and finally growing exponential which would account for purely predictive effects. We further tested how this relates to the scalp data by performing spatiotemporal analysis across time and space.

## Materials and Methods

Included participants and stimuli presented were the same as described in (Larsen *et al.*, 2017, *in prep*) but are summarized here for clarity.

### Participants

This study is part of a larger Danish nationwide study and an extensive description of the recruitment of participants is described in (Schmuck *et al.*, 2015). 19 non-psychotic 22q11.2 deletion carriers with a verified deletion within the 3 Mb region at chromosome 22q11.2 were included. All 22q11.2 deletion carriers did not have a current or previous history of schizophrenia. We further included 27 matched healthy individuals without the 22q11.2 deletion as a control group with comparable age distribution (controls age range: 12-25 years; mean age: 15.96, standard deviation (SD) = 2.71 years; 22q11 mean age: 15.47, SD 2.41 years,  $t_{44} = -0.63$   $p = 0.53$ ) and sex ratio (male/female controls: 18/9, cases: 13/6,  $\chi^2 = 0.02$ ,  $p = 0.90$ ). The International Classification of Diseases (ICD-10) system was used to evaluate the presence of current psychiatric disorders. Intellectual functioning was assessed using Reynolds Intellectual Screening Test (RIST)

(Reynolds and Kamphaus, 2011). Using the Mini International Neuropsychiatric Interview (Sheehan *et al.*, 1998) or the Mini International Neuropsychiatric Interview for Children and Adolescents (Sheehan D, Shytle, K. Milo, 2013) diagnosis of anxiety, affective disorder and disturbance of activity and attention/attention deficit disorder without hyperactivity were given. The Social Communication Questionnaire lifetime was used with a clinical cut-off of 15 to indicate presence of autism spectrum disorders (Rutter *et al.*, 2003, 2005). To screen for current psychosis and to rate the severity of schizophrenia-related symptoms the Structured Interview for Prodromal Syndromes was used (McGlashan *et al.*, 2012; Miller *et al.*, 2003). The schizophrenia-related symptoms were assessed within the four domains: positive (i.e. delusional ideas, persecutory ideas, grandiosity, hallucinations, and disorganized communication), negative (anhedonia or withdrawal, avolition, decreased expression of emotions, decreased experience of emotion or self, impoverished thinking, and deterioration of role functioning), disorganized (odd behavior and appearance, bizarre thinking, trouble with focus and attention, and personal hygiene), and general symptoms (sleep disturbance, dysphoric mood, motor disturbances, impaired tolerance to normal stress). All clinical interviews were conducted by two experienced and certified clinicians.

The following exclusion criteria were applied to controls: a) schizophrenia, schizotypal and delusional disorders (ICD10 DF20-29); b) bipolar disorder (ICD10 DF30-31); c) depression (ICD DF32-33) except for a past episode of mild or moderate depression (ICD10 DF 32.0 or 32.1); d) substance abuse; or e) a first degree relative with a psychotic illness. The regional Ethical Committee of Copenhagen (project id: H-3-2012-136) and the Danish Data protection Agency (project id: 2007-58-0015) approved the study. All participants underwent a verbal and written informed consent process. Participants under the age of 18 provided a verbal assent while their parent's completed written consent.

## **Stimuli**

The roving paradigm was adapted from (Garrido *et al.*, 2008) and comprised of roving sequences of sounds, see Figure 1. The number of repetitions within each sequence ranged from 1 to 9 and was drawn from a discrete uniform distribution. With this paradigm it is possible to study the responses to repeated stimulation and thereby the parametric effect of repetition. Each tone was a pure sinusoidal tone with frequency 1000 Hz or 1200 Hz and had a duration of 50 ms with a 5 ms rise and fall time. Tones were delivered binaurally via insert-earphones (E-A-RTONE 3A Indianapolis, US), at 85 dB SPL, generated with the Cogent toolbox) running in Matlab ([http://www.vislab.ucl.ac.uk/cogent\\_2000.php](http://www.vislab.ucl.ac.uk/cogent_2000.php)). Participants sat in a comfortable chair and watched a silent movie displaying underwater scenery free of any sudden or salient visual events during the 15 minutes of recording. Participants were instructed to ignore the sounds. In order to ensure that participants could hear the stimuli, audiometric testing was performed prior to the experiment (20dB random test Oscilla USB-310 Tablet screening audiometer, Aarhus, Denmark).

At 1000 Hz the observed threshold levels were (mean = 20.1, SD = 0.5) for controls and (mean = 23.4, SD = 4.0) for 22q11.2.

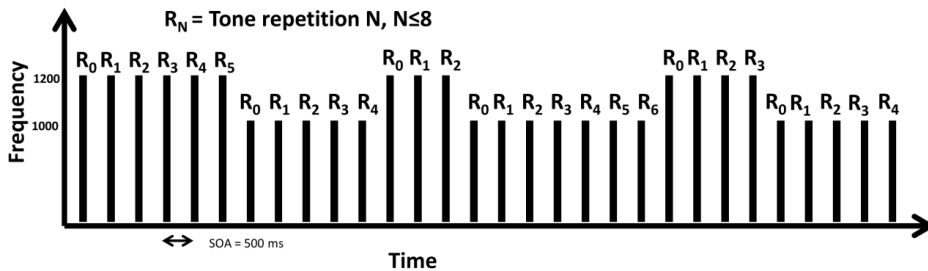

**Figure 1: Experimental design of the roving paradigm.** The tone repetition,  $R_N$ , varies randomly between 0 and 8 (corresponding to a maximum of 9 tones). The sequences of tones vary by having a frequency of either 1000 Hz or 1200 Hz. The stimulus onset asynchrony is fixed at 500ms.

### Data acquisition and pre-processing

EEG data were recorded using a 128 channel ActiveTwo Biosemi System (BioSemi, Amsterdam, Netherlands), with a sampling frequency of 4096 Hz. Pre-processing included; referencing to the nose, bandpass filtering between 0.5Hz - 40Hz using a second order Butterworth filter, downsampling to 500Hz and finally epoching with a peristimulus window of -100ms to 400ms. The preprocessing was carried out using EEGLAB (Delorme and Makeig, 2004). Baseline correction was applied using the average over the time window -100ms to -10ms. Artefact removal, scalp analysis, and the DCM analysis were performed using SPM12b (<http://www.fil.ion.ucl.ac.uk/spm/>). For artefact removal, a simple threshold approach was applied, where epochs were rejected if their values exceeded  $\pm 100 \mu\text{V}$ . One of the participants (belonging to the 22q11.2 group) was discarded because the majority of epochs were rejected with this approach (above 80%). For the spatio-temporal analysis in sensor space, the epoched EEG data were converted into scalp-map images of dimension 64x64 obtained using interpolation. After the conversion to scalp-map images smoothing using a Gaussian kernel specified by a FWHM of 8 mm<sup>2</sup> in the spatial dimension and 10ms in the temporal dimension ([8 8 10]) was performed. Before the DCM analysis was carried out the data was re-referenced to the average of all sensors to enable proper source reconstruction.

### Dynamic Causal Modelling

DCM is a method to estimate effective connectivity by explaining measured data using a hierarchical network of interacting sources. Effective connectivity is the influence one neural system exerts over another (David et al., 2006; Friston et al., 2003).

DCM for ERPs is specified by state equations and an output function. The state equations build upon neural mass models, describing neural activity at the source level based on the model by (Jansen and Rit, 1995) and connectivity rules described in (Felleman and Van Essen, 1991), see equation 1.



The output function then relates the activity at the source level, to the activity at the scalp level. This is done by an electromagnetic forward model, with leadfield matrix  $L(\varphi)$ , coupling the average depolarization of pyramidal cells in each source  $x_0$ , to the scalp data,  $y$ , see equation 2.

$$\dot{x} = f(x, u, \theta) \text{ (eq 1)}$$

$$y = L(\varphi) x_0 + \varepsilon \text{ (eq 2)}$$

The spatial forward model, given by the lead field matrix  $L(\varphi)$ , is parametrized by the location and orientation of each source (Kiebel *et al.*, 2006). Each source in the network is modelled as an equivalent current dipole. Finally a Gaussian error term  $\varepsilon$  is included to account for noise. By inverting the DCM, using Bayesian model inversion, the effective connectivity within a given model is estimated.

In the comparison of models we used random effects (Penny *et al.*, 2010) allowing for the possibility that participants use different cognitive strategies and brain networks. In the same way as making inference on model structures, it is possible to make inferences on general properties of network structure by dividing the model space into family partitions (Penny *et al.*, 2010). Exceedance probability is an expression of how likely it is that a particular family is preferred over another family of models. We used this measure in our comparisons of families.

### **Model space specification**

We have previously used the same paradigm to study MMN responses in 22q11.2DS (Larsen *et al.*, 2017, in prep) where we formulated a set of models motivated by previous studies on MMN generators (Doeller *et al.*, 2003; Grau *et al.*, 2007; Opitz *et al.*, 2002; Rinne *et al.*, 2000) as well as previous model comparisons on MMN (Boly *et al.*, 2011; Garrido *et al.*, 2007, 2008, 2009c). This network includes bilateral sources in the primary auditory cortex (A1), superior temporal gyrus (STG) and inferior frontal gyrus (IFG), with the IFG usually being most consistent in the right side. The bilateral sources in A1 receive the input. Repetition suppression in a roving MMN paradigm has been previously studied using DCM (Garrido *et al.*, 2009a) with bilateral A1 and STG sources being included. The purpose of that study was to assess whether repetition dependent changes in responses to repeated stimuli is due to connectivity changes in such network. Here, we explore other possible networks which may underly repetition dependent changes. We therefore defined 16 models starting with the right and left A1 and building the remaining models by adding hierarchical levels until we had a full network comprising the six sources: bilateral A1, STG and IFG (see Figure 2). By using this model space we ensured that the three hypotheses of the underlying mechanisms of MMN were captured, namely the adaptation hypothesis, the model-adjustment hypothesis, and finally the predictive coding hypothesis (see (Garrido *et al.*, 2009b) for a review).

### Repetition-dependent effects

Each DCM model (Figure 2) was estimated for each participant individually with all nine tones in the same model. Since we were interested in the repetition dependent changes in effective connectivity, we explored three different between trial effects, given below for tone  $r = 1, \dots, 9$ .

$$\begin{aligned}U - shape: x_1(r) &= (r - 5)^2 \\Decaying exponential: x_2(r) &= \exp(-r) \\Growing exponential: x_3(r) &= \exp(r)\end{aligned}$$

Using these three parametric forms we could test three different hypotheses for the repetition-dependent changes in effective connectivity. The u-shaped function is a combination of the decaying and growing exponential and is in line with the predictive coding theory. Hence, the first decay will capture changes due to habituation or adaptation whereas the growing part in the end will capture formation of an expectation, or prediction, that a new event will occur. The decaying exponential function then models the connectivity as a decrease throughout the number of repetitions, meaning that repetition suppression can be explained purely by habituation or adaptation. Conversely, the growing exponential function models the changes in connectivity with an increase most pronounced for the last repetitions, indicating formation of an expectation, or prediction, that a new event will occur. We defined each of these parametric forms as families where these families only deviate in the specific parametric effect.

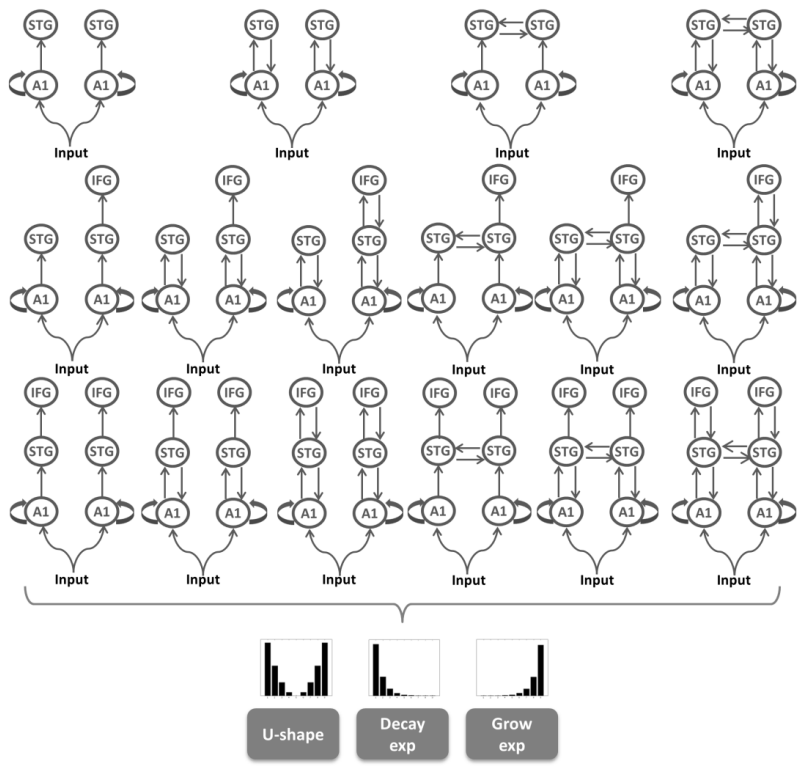

**Figure 2: The three different repetition effect families.** Each family consists of the same models, but deviates in the parametric modulation between the conditions (repetitions of tones). The three different modulations tested are; u-shape, decaying exponential and growing exponential.

## Statistical analysis

### Clinical scores

To test for carrier-control differences in SIPS scores we used Wilcoxon rank sum test. A two sample t-test was used to test for differences in IQ levels between carriers and controls.

### DCM

Random effects Bayesian model selection was used for the pooled group (carriers and controls) to test which of these effects best described the data. Exceedance probabilities were used to compare families. BMA was carried out within the family with highest exceedance probability. With BMA the connectivity parameters are estimated by weighting the contribution of each model to the mean by its probability. In this way brittle assumptions about the model structure can be avoided.

To test for differences in the connectivity modulation parameters (B-parameters), a one-way ANCOVA with group as a factor (carriers and controls) and age and sex as covariates was performed for each of the parameters. Results are reported both uncorrected as well as corrected for multiple comparison using Bonferroni.

### Spatiotemporal analysis

Spatio-temporal analysis was performed over the whole sensor-space (i.e. all electrodes) and time (-100 ms to 400 ms) using a full factorial 2x9 design with factors group (controls and carriers) and condition (nine repetitions of the tone). Further, age and sex was included as covariates. With this approach we could do an unbiased assumption-free search for differences (main effects and interactions) over the entire sensor-time volume and use random field theory to correct for multiple comparison testing (Kilner and Friston, 2010). Importantly, we could test the parametric effect of tone repetition relating the results obtained in the DCM analysis to the sensor data. All p values reported are thresholded using  $p < 0.05$  FWE corrected at cluster level.

## Results

Of the 19 22q11.2 deletion carriers included in the study, one was diagnosed with affective disorder, two with disturbance of activity/attention deficit disorder without hyperactivity, seven with anxiety or phobia and one with both autism spectrum disorder and anxiety or phobia. Only one 22q11.2 deletion carriers took medication acting on the central nervous system at the time of examination (20 mg retalin). None of the participants had psychosis but the 22q11.2DS group had significantly elevated SIPS scores for all four SIPS symptom domains; negative ( $W = 497.5$ ,  $p < 0.001$ ), positive ( $W = 376$ ,  $p = .004$ ), disorganized ( $W = 416.5$ ,  $p < 0.001$ ) and generalized ( $W =$

324.5,  $p=0.037$ ) symptoms, relative to the control group. The raw sum of negative symptoms in the 22q11.2 carriers ranged from 1-16 (mean = 6.7, SD = 3.7), from 0-12 for positive symptoms (mean = 2.7, SD = 3.1), from 0-6 for disorganized symptoms (mean = 1.7, SD = 1.8), and from 0-7 for generalized symptoms (mean = 0.9, SD = 1.9).

The 22q11.2DS group had an IQ (median = 82.0, 90<sup>th</sup> percentile = 94.4, 10<sup>th</sup> percentile = 63.8) below the control group (median 108.0, 90<sup>th</sup> percentile = 127.0, 10<sup>th</sup> percentile = 95.2,  $t_{44}=-7.01$ ,  $p < 0.001$ ).

We have previously confirmed the presence of repetition dependent responses in this paradigm in the form of a detectable MMN response, see results in (Larsen *et al.*, 2017, *in prep*). Figure 3 shows responses to each tone repetition.

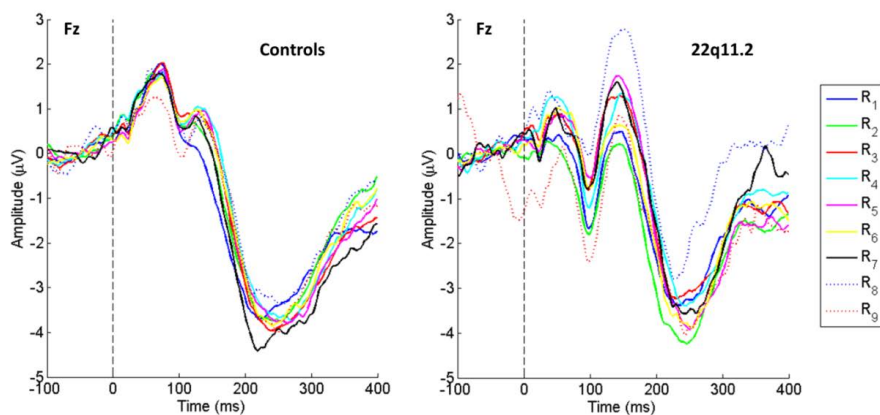

**Figure 3: Grand average responses for controls and 22q11.2 deletion carriers from channel Fz.** To the left, responses to each tone repetition can be seen for the controls. Corresponding responses for the 22q11.2 deletion carriers can be seen to the right.

### Repetition-dependent changes – a parametric DCM

Figure 4 shows exceedance probabilities for the three parametric effects tested; u-shape, decaying exponential, and growing exponential for the pooled group (controls and 22q11.2). The family with the u-shaped function as parametric modulation outperforms both the growing exponential modulation as well as the decaying exponential modulation. The fact that the u-shaped function shows the highest exceedance probability suggests that repetition-dependent changes in effective connectivity can be interpreted within the framework of predictive coding. This implies that the first repetitions are explained by habituation or adaptation whereafter expectations build up towards the last repetitions.

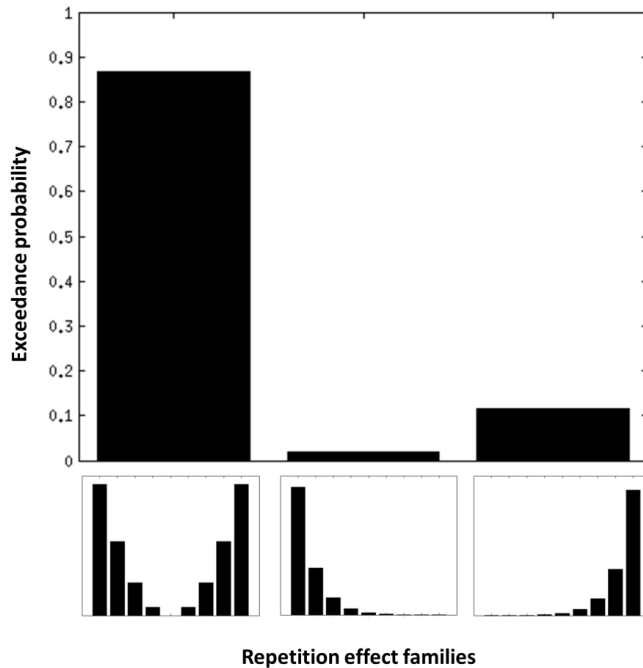

**Figure 4: Exceedance probabilities of the three repetition effect families.** The u-shaped function outperforms both the decaying exponential as well as the growing exponential.

The 22q11.2 deletion carriers showed a stronger modulation than controls in the extrinsic connection from left STG to left IFG ( $F_{1,41} = 8.057$ ,  $p = 0.007$ ). The connection decreased with age ( $F_{1,41} = 7.314$ ,  $p = 0.010$ ) indicating that older showed a stronger modulation than younger. There was no effect of the covariate sex observed. While this effect is suggestive, it did not survive correction for multiple comparisons using a conservative Bonferroni correction for 12 tests ( $\alpha = 0.05/12 = 0.004$ ). We post-hoc tested if the group effect of this connection was driven by hearing levels and IQ and none of these variables correlated with the connection.

Within the u-shaped family we performed a new model selection using random effect analysis in the pooled group (carriers and controls) to see which models best described the data. However, in the absence of a clear winning model (i.e. a flat profile) we decided to keep the inference at the family level.

### Spatiotemporal analysis

Analysis of the scalp maps of the repeated stimuli revealed a significant main effect of group (see Figure 5, left) peaking at 90 ms in the fronto-central areas. This effect was driven by a more negative N1 amplitude in the 22q11.2 deletion carriers, indicative of a failure to suppress responses to repeated stimuli in carriers compared to controls. Further, there was a main effect of group peaking at 180 ms in a small cluster of electrodes in the fronto-central area. This effect was

driven by 22q11.2 deletion carriers showing reduced responses around 180 ms, suggesting that the early N2 component is reduced in carriers as compared to controls. No main effect of repetition or group by repetition interaction effect was observed at the reported corrected threshold.

Assuming that the repetition dependent changes in connectivity was modulated by a u-shaped function, we looked at the contrast ushape controls > ushape carriers to see if this effect was more present in the controls than the carriers. Having a greater u-shaped effect would mean greater prediction error responses when a change occurs followed by a decay as the deviant becomes a standard and then a gradual increase again in prediction error, as the expected change does not occur. This showed a cluster peaking at 90 ms, see Figure 5, right.

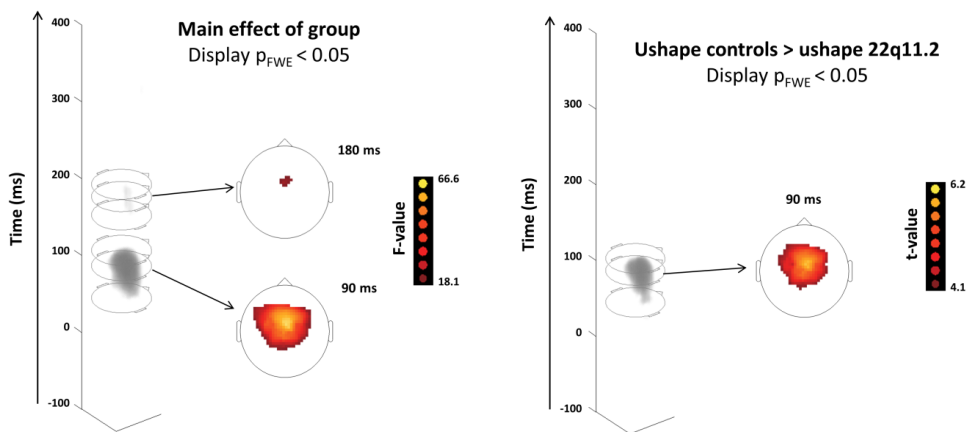

**Figure 5: Statistical t-maps showing results from the full factorial design.** Left: Main effect of group ( $p=0.05$  FWE corrected) over the entire scalp and time. There is a significant cluster in the fronto-central area peaking at 90 ms as well as at 180 ms. Right: The contrast ushape controls > ushape 22q11.2, shows that there is a significant cluster at 90 ms in the fronto-central area.

Since 22q11.2DS is associated with hearing loss (Jiramongkolchai *et al.*, 2016) and lower IQ levels (Gothelf *et al.*, 2007; Vorstman *et al.*, 2015) we did a post-hoc analysis to test if these variables could explain any main effect of group observed in the spatio-temporal analysis. We found that IQ correlated with the EEG data, however, this effect was located on different spatiotemporal regions than the observed group effect and we therefore conclude that the lower levels of IQ in the 22q11.2 deletion carriers did not drive the main effect of group. We did not find an effect of hearing levels. There was no correlation between the EEG responses as well as the connectivity from left IFG to left STG and the raw sum of negative symptoms.

## Discussion

In this study we investigated the responses to repeated auditory stimulation arranged in a roving MMN paradigm, in a group of young 22q11.2 deletion carriers and a group of age and sex comparable healthy controls. The parametric effect underlying repetition-dependent changes of

effective connectivity were investigated with DCM. Results suggest that repetition-dependent changes in effective connectivity are modulated by a u-shaped function, and a trend for a stronger modulation on 22q11.2 carriers than controls in the forward connection from left STG to left IFG. Spatiotemporal analysis revealed a group difference in the responses to tones in the fronto-central areas peaking at 90 ms. This effect was due to the 22q11.2 carriers showing a more negative response around 90 ms, suggesting that the ability to suppress the tones in the same manner as controls is disrupted. Further, we found a reduction of responses to tones in the fronto-central area at 180 ms for the 22q11.2 carriers as compared to controls, suggesting that the early N2 component is reduced in 22q11.2 carriers.

Within the framework of predictive coding, repetition suppression is understood in terms of perceptual inference and learning where changes in repetition-dependent activity are mediated by synaptic communication (Auksztulewicz and Friston, 2016; Friston, 2005). In this context, the brain constantly updates expectations and predictions, by passing prediction errors up the hierarchy to optimize predictions that are passed back or down the hierarchy. If predictions match incoming inputs, the prediction errors will be low and therefore only small updates of expectations takes place. Our analysis points to repetition-dependent changes in connectivity can be explained with a u-shaped function. Hence, for the first half of tone repetitions ( $R_0$ - $R_4$ ) the connectivity decreases whereas for the second half ( $R_4$ - $R_8$ ) the connectivity strength increases. This indicates that participants are able to learn the statistical regularity of the roving MMN paradigm by starting to predict that a new event is likely to happen after the fourth repetition of the tone. This is in line with the notion that repetition suppression is not only caused by simple mechanisms as neural fatigue, but is likely to be caused by fulfilled expectations (Auksztulewicz and Friston, 2016; Summerfield *et al.*, 2008; Todorovic *et al.*, 2011) including forward message passing of prediction error and backward message passing of predictions or expectations. Comparing connectivity parameters between groups indicated an increase in the modulation between tones for the 22q11.2 carriers from left STG to left IFG where carriers show an increased modulation compared to controls. According to predictive coding this indicates that 22q11.2 carriers have greater prediction errors, meaning that they are more surprised. However, this connection did not survive correction for multiple comparison, meaning that cautions should be taken when interpreting this. Repetition suppression has previously been shown to be reduced in schizophrenia (Gonzalez-Heydrich *et al.*, 2016) in reduced N1 adaptation, or failure to suppress N1. In the present study we found an enhanced response at the N1 component in the 22q11.2 carriers compared to controls. This indicates that 22q11.2 carriers have a reduced ability to suppress the responses to tones through a reduced adaptation, similarly to patients with schizophrenia. This is supported by the theory of psychosis as a state of aberrant salience, where common events have enhanced salience (Kapur, 2003; Roiser *et al.*, 2009, 2013). Crucially, it is important to note that 22q11.2 deletions carriers included in the present study do not show any sign of psychosis and therefore our findings indicate that such failure to suppress N1 responses to repeated stimuli may be apparent prior to disease onset.



22q11.2 carriers showed a reduction in responses to tones at 180 ms as compared to controls. This indicates that the early N2 component is reduced in 22q11.2 carriers. N2 amplitudes have previously been found to be reduced in schizophrenia (Ethridge *et al.*, 2015; Javitt *et al.*, 1995; O'Donnell *et al.*, 1993, 2004), a component that has been associated with the process of stimulus classification.

In conclusion, this study supports that repetition-dependent changes in effective connectivity is modulated by a u-shaped function, in accordance with the predictive coding theory of repetition suppression and prediction formulation. Our findings add to the current literature on repetition suppression in the healthy human brain perceived as a consequence of fulfilled expectations. We further show that 22q11.2 deletion carriers lack the ability to adapt to the environment by showing a reduced adaptation to the repetition of tones. In addition to this, N2 amplitudes were reduced in 22q11.2 deletion carriers, which is consistent with previous findings in patients with schizophrenia. In sum, we suggest that the typical N1 enhancement and N2 reduction observed in schizophrenia are also present in 22q11.2 deletion carriers prior to psychosis onset. These alteration could potentially be associated with plastic changes in a fronto-temporal network.

## **Acknowledgements**

We would like to thank all the participants and families for taking the time to participate in our study and the Danish National 22q11DS Association for their strong support of our work. We highly appreciate the efforts of Anders Vangkilde and Henriette Schmock for their dedicated assistance in the recruitment and clinical assessments. We would also like to express our gratitude to the staff involved in the Danish Blood Donor Study, Capital Region Blood bank, Glostrup. Further, we would like to thank <http://www.forsogsperson.dk/> from which our control participants were recruited from.

This study was funded by the Lundbeck Foundation, Denmark (R155-2014-1724); Lundbeck Foundation [Grant of Excellence "ContAct" R59 A5399]; Lundbeck Foundation fellowship (R105-9813); The Capital Region's Research Foundation for Mental Health Research. MIG is recipient of a University of Queensland Fellowship (2016000071).

## **Financial disclosures**

H.R.S. received honoraria as speaker from Lundbeck A/S, Valby, Denmark, Biogen Idec, Denmark A/S, Genzyme, Denmark and MerckSerono, Denmark, honoraria as editor from Elsevier Publishers, Amsterdam, The Netherlands and Springer Publishing, Stuttgart, Germany, travel support from MagVenture, Denmark, and grant support from Biogen Idec, Denmark A/S. M.R.B is a prior employee at H. Lundbeck A/S, Denmark and received financial support for her PhD from the Innovation Fund Denmark. M.D is employed with Lundbeck A/S. The authors declare no further biomedical financial interests or potential conflicts of interest.

This article is distributed under the Danish legislation governed by the Privacy Act (act# 429, 31/05/2000), which does not permit data sharing at publicly available repositories or in raw formats. Summary statistics can be obtained through contact with the corresponding author ([melissal@drcmr.dk](mailto:melissal@drcmr.dk)).

## References

- Adams RA, Stephan KE, Brown HR, Frith CD, Friston KJ. The computational anatomy of psychosis. *Front. psychiatry* 2013; 4: 47.
- Auksztulewicz R, Friston K. Repetition suppression and its contextual determinants in predictive coding. *Cortex* 2016; 80: 125–140.
- Baker K, Baldeweg T, Sivagnanasundaram S, Scambler P, Skuse D. COMT Val108/158Met modifies mismatch negativity and cognitive function in 22q11 deletion syndrome. *Biol. Psychiatry* 2005; 58: 23–31.
- Baldeweg T. ERP repetition effects and mismatch negativity generation: A predictive coding perspective. *J. Psychophysiol.* 2007; 21: 204–213.
- Bassett AS, Marshall CR, Lionel AC, Chow EWC, Scherer SW. Copy number variations and risk for schizophrenia in 22q11.2 deletion syndrome. *Hum. Mol. Genet.* 2008; 17: 4045–53.
- Boly M, Garrido MI, Gosseries O, Bruno M -a., Boveroux P, Schnakers C, et al. Preserved Feedforward But Impaired Top-Down Processes in the Vegetative State. *Science* (80-. ). 2011; 332: 858–862.
- Catts S V, Shelley AM, Ward PB, Liebert B, McConaghy N, Andrews S, et al. Brain potential evidence for an auditory sensory memory deficit in schizophrenia. *Am. J. Psychiatry* 1995; 152: 213–9.
- Doeller CFC, Opitz B, Mecklinger A, Krick C, Reith W, Schröger E. Prefrontal cortex involvement in preattentive auditory deviance detection: Neuroimaging and electrophysiological evidence. *Neuroimage* 2003; 20: 1270–1282.
- Ethridge LE, Hamm JP, Pearlson GD, Tamminga CA, Sweeney JA, Keshavan MS, et al. Event-related potential and time-frequency endophenotypes for schizophrenia and psychotic bipolar disorder. *Biol. Psychiatry* 2015; 77: 127–36.
- Felleman DJ, Van Essen DC. Distributed hierarchical processing in the primate cerebral cortex. *Cereb. Cortex* 1991; 1: 1–47.
- Friston K. Learning and inference in the brain. *Neural Networks* 2003; 16: 1325–1352.
- Friston K. A theory of cortical responses. *Philos. Trans. R. Soc. Lond. B. Biol. Sci.* 2005; 360: 815–36.
- Garrido MI, Friston KJ, Kiebel SJ, Stephan KE, Baldeweg T, Kilner JM. The functional anatomy of the MMN: A DCM study of the roving paradigm. *Neuroimage* 2008; 42: 936–944.
- Garrido MI, Kilner JM, Kiebel SJ, Friston KJ. Evoked brain responses are generated by feedback loops. *Proc. Natl. Acad. Sci. U. S. A.* 2007; 104: 20961–20966.
- Garrido MI, Kilner JM, Kiebel SJ, Stephan KE, Friston KJ. Repetition suppression and plasticity in the human brain. *Neuroimage* 2009a; 48: 269–279.
- Garrido MI, Kilner JM, Stephan KE, Friston KJ. The mismatch negativity: A review of underlying

mechanisms. *Clin. Neurophysiol.* 2009b; 120: 453–463.

Garrido MI, Kilner J, Kiebel S, Friston K. Dynamic causal modeling of the response to frequency deviants. *J. Neurophysiol.* 2009c; 101: 2620–2631.

Gonzalez-Heydrich J, Bosquet Enlow M, D'Angelo E, Seidman LJ, Gumlak S, Kim A, et al. N100 Repetition Suppression Indexes Neuroplastic Defects in Clinical High Risk and Psychotic Youth. *Neural Plast.* 2016; 2016: 1–11.

Goodship J, Cross I, Liling J, Wren C. A population study of chromosome 22q11 deletions in infancy. *Arch. Dis. Child.* 1998; 79: 348–51.

Gothelf D, Feinstein C, Thompson T, Gu E, Penniman L, Van Stone E, et al. Risk factors for the emergence of psychotic disorders in adolescents with 22q11.2 deletion syndrome. *Am. J. Psychiatry* 2007; 164: 663–669.

Grau C, Fuentemilla L, Marco-Pallares J. Functional neural dynamics underlying auditory event-related N1 and N1 suppression response. *Neuroimage* 2007; 36: 522–531.

Grill-Spector K, Henson R, Martin A. Repetition and the brain: neural models of stimulus-specific effects. *Trends Cogn. Sci.* 2006; 10: 14–23.

Jansen BH, Rit VG. Electroencephalogram and visual evoked potential generation in a mathematical model of coupled cortical columns. *Biol. Cybern.* 1995; 73: 357–366.

Javitt DC, Doneshka P, Grochowski S, Ritter W. Impaired Mismatch Negativity Generation Reflects Widespread Dysfunction of Working Memory in Schizophrenia. *Arch. Gen. Psychiatry* 1995; 52: 550.

Jiramongkolchai P, Kumar MS, Chinnadurai S, Wootten CT, Goudy SL. Prevalence of hearing loss in children with 22q11.2 deletion syndrome. *Int. J. Pediatr. Otorhinolaryngol.* 2016; 87: 130–133.

Kapur S. Psychosis as a state of aberrant salience: a framework linking biology, phenomenology, and pharmacology in schizophrenia. *Am. J. Psychiatry* 2003; 160: 13–23.

Karayiorgou M, Simon TJ, Gogos J a. 22q11.2 microdeletions: linking DNA structural variation to brain dysfunction and schizophrenia. *Nat. Rev. Neurosci.* 2010; 11: 402–416.

Kiebel SJ, David O, Friston KJ. Dynamic causal modelling of evoked responses in EEG/MEG with lead field parameterization. *Neuroimage* 2006; 30: 1273–1284.

Kilner J, Friston K. Topological inference for EEG and MEG. *Ann. Appl. Stat.* 2010; 4: 1272–1290.

Larsen KM, Mørup M, Birkenow MR, Fischer E, Hulme O, Vangkilde A, et al. Impaired top-down processing in 22q11 Deletion Syndrome; an early risk marker for schizophrenia? *Manuscr. Prep.* 2017

Michie PT. What has MMN revealed about the auditory system in schizophrenia? *Int. J. Psychophysiol.* 2001; 42: 177–194.

Näätänen R, Kähkönen S. Central auditory dysfunction in schizophrenia as revealed by the mismatch negativity (MMN) and its magnetic equivalent MMNm: a review. *Int. J. Neuropsychopharmacol.* 2009; 12: 125–135.

O'Donnell B., Vohs J., Hetrick W., Carroll C., Shekhar A. Auditory event-related potential abnormalities in bipolar disorder and schizophrenia. *Int. J. Psychophysiol.* 2004; 53: 45–55.

O'Donnell BF, Shenton ME, McCarley RW, Faux SF, Smith RS, Salisbury DF, et al. The auditory N2 component in schizophrenia: relationship to MRI temporal lobe gray matter and to other ERP abnormalities. *Biol. Psychiatry* 1993; 34: 26–40.

Opitz B, Rinne T, Mecklinger A, von Cramon DY, Schröger E. Differential contribution of frontal and temporal cortices to auditory change detection: fMRI and ERP results. *Neuroimage* 2002; 15: 167–174.

Oskarsdóttir S, Vujic M, Fasth A. Incidence and prevalence of the 22q11 deletion syndrome: a population-based study in Western Sweden. *Arch. Dis. Child.* 2004; 89: 148–51.

Purcell SM, Wray NR, Stone JL, Visscher PM, O'Donovan MC, Sullivan PF, et al. Common polygenic variation contributes to risk of schizophrenia and bipolar disorder. *Nature* 2009; 460: 748–52.

Rao RP, Ballard DH. Predictive coding in the visual cortex: a functional interpretation of some extra-classical receptive-field effects. *Nat. Neurosci.* 1999; 2: 79–87.

Reynolds CR&, Kamphaus RW. Reynolds Intellectual Assessment Scales (RIAS), Reynolds Intellectual Screening Test (RIST). Dansk version - Vejledning. Hogrefe Psykologisk Forlag. København, Danmark; 2011.

Rihs T a, Tomescu MI, Britz J, Rochas V, Custo A, Schneider M, et al. Altered auditory processing in frontal and left temporal cortex in 22q11.2 deletion syndrome: a group at high genetic risk for schizophrenia. *Psychiatry Res.* 2013; 212: 141–9.

Rinne T, Alho K, Ilmoniemi R, Virtanen J, Näätänen R. Separate time behaviors of the temporal and frontal mismatch negativity sources. *Neuroimage* 2000; 12: 14–19.

Robin NH, Shprintzen RJ. Defining the clinical spectrum of deletion 22q11.2. *J. Pediatr.* 2005; 147: 90–6.

Roiser JP, Howes OD, Chaddock CA, Joyce EM, McGuire P. Neural and behavioral correlates of aberrant salience in individuals at risk for psychosis. *Schizophr. Bull.* 2013; 39: 1328–36.

Roiser JP, Stephan KE, den Ouden HEM, Barnes TRE, Friston KJ, Joyce EM. Do patients with schizophrenia exhibit aberrant salience? *Psychol. Med.* 2009; 39: 199–209.

Rutter M, Bailey A, Berument SK, Lord C, Pickles A. The Social Communication Questionnaire (SCQ). Dansk version - Vurdering Livsforløb. Hogrefe Psykologisk Forlag. København, Danmark; 2005.

Rutter M, Bailey A, Lord C. The Social Communication Questionnaire (SCQ). Manual. (Form: Lifetime). Western Psychological Services. Los Angeles, CA; 2003.

Schmock H, Vangkilde A, Larsen KM, Fischer E, Birknow MR, Jepsen JRM, et al. The Danish 22q11 research initiative. *BMC Psychiatry* 2015; 15: 220.

Schneider M, Debbané M, Bassett AS, Chow EWC, Fung WLA, van den Bree M, et al. Psychiatric disorders from childhood to adulthood in 22q11.2 deletion syndrome: results from the International Consortium on Brain and Behavior in 22q11.2 Deletion Syndrome. *Am. J. Psychiatry* 2014; 171: 627–39.

Sheehan D V., Lecrubier Y, Sheehan KH, Amorim P, Janavs J, Weiller E, et al. The Mini-International Neuropsychiatric Interview (M.I.N.I.): The development and validation of a structured diagnostic psychiatric interview for DSM-IV and ICD-10. In: *Journal of Clinical Psychiatry*. 1998. p. 22-33-57.

Sheehan D, Shytle, K. Milo JJY. M.I.N.I. International Neuropsychiatric Interview For Children and Adolescents (M.I.N.I.-Kid). Dansk Version 6.0 2013; 2013.

Shprintzen RJ. Velo-cardio-facial syndrome. In: Cassidy SB AJ, editor(s). *Management of Genetic Syndromes*. 2. New York: Wiley-Liss; 2005. p. 615–632.

Stefansson H, Rujescu D, Cichon S. Large recurrent microdeletions associated with schizophrenia. *Nature* 2008; 455: 232–236.

Summerfield C, Trittshuh EH, Monti JM, Mesulam M-M, Egner T. Neural repetition suppression reflects fulfilled perceptual expectations. *Nat. Neurosci.* 2008; 11: 1004–1006.

Todorovic A, van Ede F, Maris E, de Lange FP. Prior expectation mediates neural adaptation to repeated sounds in the auditory cortex: an MEG study. *J. Neurosci.* 2011; 31: 9118–23.

Todorovic A, de Lange FP. Repetition suppression and expectation suppression are dissociable in time in early auditory evoked fields. *J. Neurosci.* 2012; 32: 13389–95.

Umbricht D, Krljesb S. Mismatch negativity in schizophrenia: A meta-analysis. *Schizophr. Res.* 2005; 76: 1–23.

Vangkilde A, Olsen L, Hoeffding LK, Pedersen CB, Mortensen PB, Werge T, et al. Schizophrenia Spectrum Disorders in a Danish 22q11.2 Deletion Syndrome Cohort Compared to the Total Danish Population—A Nationwide Register Study. *Schizophr. Bull.* 2016; 42: 824–831.

Vorstman JAS, Breetvelt EJ, Duijff SN, Eliez S, Schneider M, Jalbrzikowski M, et al. Cognitive decline preceding the onset of psychosis in patients with 22q11.2 deletion syndrome. *JAMA psychiatry* 2015; 72: 377–85.

Zarchi O, Carmel M, Avni C, Attias J, Frisch A, Michaelovsky E, et al. Schizophrenia-like neurophysiological abnormalities in 22q11.2 deletion syndrome and their association to COMT and PRODH genotypes. *J. Psychiatr. Res.* 2013; 47: 1623–9.



APPENDIX C

22q11.2 deletion syndrome  
is associated with an  
impaired auditory  
steady-state gamma  
response

---



Draft Manuscript for Review. Please review online at <http://mc.manuscriptcentral.com/oup/szbltn>

## 22q11.2 deletion syndrome is associated with impaired auditory steady-state gamma response

Journal:	<i>Schizophrenia Bulletin</i>
Manuscript ID	SZBLTN-ART-16-0451.R2
Manuscript Type:	Regular Article
Date Submitted by the Author:	14-Mar-2017
Complete List of Authors:	<p>Larsen, Kit; Danish Research Centre for Magnetic Resonance, Centre for Functional and Diagnostic Imaging and Research; DTU Compute, Cognitive Systems; Institute of Biological Psychiatry, Mental Health Centre Sct. Hans; iPSYCH, The Lundbeck Foundation Initiative for Integrative Psychiatric Research</p> <p>Pellegrino, Giovanni; Danish Research Centre for Magnetic Resonance, Centre for Functional and Diagnostic Imaging and Research</p> <p>Birknow, Michelle; Synaptic Transmission, H. Lundbeck A/S; Institute of Biological Psychiatry, Mental Health Centre Sct. Hans; iPSYCH, The Lundbeck Foundation Initiative for Integrative Psychiatric Research</p> <p>Kjær, Trine; Danish Research Centre for Magnetic Resonance, Centre for Functional and Diagnostic Imaging and Research; DTU Compute, Cognitive Systems; iPSYCH, The Lundbeck Foundation Initiative for Integrative Psychiatric Research</p> <p>Baare, William; Danish Research Centre for Magnetic Resonance, Centre for Functional and Diagnostic Imaging and Research</p> <p>Didriksen, Michael; Synaptic Transmission, H. Lundbeck A/S</p> <p>Olsen, Line; Institute of Biological Psychiatry, Mental Health Centre Sct. Hans; iPSYCH, The Lundbeck Foundation Initiative for Integrative Psychiatric Research</p> <p>Werge, Thomas; University of Copenhagen, Department of Clinical Medicine; Mental Health Services of Copenhagen, Institute of Biological Psychiatry; Kobenhavns Universitet Sundhedsvidenskabelige Fakultet, Department of Clinical Medicine</p> <p>Mørup, Morten; DTU Compute, Cognitive Systems</p> <p>Siebner, Hartwig; Danish Research Centre for Magnetic Resonance, Centre for Functional and Diagnostic Imaging and Research; University of Copenhagen, Department of clinical medicine; Copenhagen University Hospital Bispebjerg</p>
Keywords:	22q11.2 Deletion Syndrome, Gamma-band, Oscillations, Schizophrenia, EEG



1  
2  
3  
4  
5  
6  
7  
8  
9  
10  
11  
12  
13  
14  
15  
16  
17  
18  
19  
20  
21  
22  
23  
24  
25  
26  
27  
28  
29  
30  
31  
32  
33  
34  
35  
36  
37  
38  
39  
40  
41  
42  
43  
44  
45  
46  
47  
48  
49  
50  
51  
52  
53  
54  
55  
56  
57  
58  
59  
60

**22q11.2 deletion syndrome is associated with impaired auditory steady-state gamma response**

Running title: Impaired ASSR in 22q11.2 deletion syndrome

Kit Melissa Larsen <sup>\*a,b,c,d</sup>, Giovanni Pellegrino <sup>a</sup>, Michelle Rosgaard Birknow <sup>c,d,e</sup>,  
Trine Nørgaard Kjær <sup>a,b,d</sup>, William Frans Christiaan Baaré <sup>a</sup>, Michael Didriksen <sup>e</sup>, Line Olsen <sup>c,d</sup>,  
Thomas Werge <sup>c,d,f</sup>, Morten Mørup <sup>b\*\*</sup>, Hartwig Roman Siebner <sup>a,f,g\*\*</sup>

## Affiliations

<sup>a</sup> Danish Research Centre for Magnetic Resonance, Centre for Functional and Diagnostic Imaging  
and Research, Copenhagen University Hospital Hvidovre, Hvidovre, Denmark

<sup>b</sup> DTU Compute, Cognitive Systems, Technical University of Denmark, Lyngby, Denmark

<sup>c</sup> Institute of Biological Psychiatry, Mental Health Centre Sct. Hans, Copenhagen University  
Hospital, Boserupvej 2, DK-4000 Roskilde, Denmark

<sup>d</sup> iPSYCH, The Lundbeck Foundation Initiative for Integrative Psychiatric Research, Aarhus and  
Copenhagen, Denmark

<sup>e</sup> Synaptic Transmission, H. Lundbeck A/S, Ottiliavej 9, DK-2500 Valby, Denmark

<sup>f</sup> Department of Clinical Medicine, Faculty of Health and Medical Sciences, University of  
Copenhagen, Copenhagen, Denmark

<sup>g</sup> Department of Neurology, Copenhagen University Hospital Bispebjerg, Copenhagen, Denmark

\* Corresponding author

Melissa Larsen. Danish Research Centre for Magnetic Resonance, Centre for Functional and  
Diagnostic Imaging and Research, Copenhagen University Hospital Hvidovre, Kettegaard Allé 30,  
2650 Hvidovre, Denmark. Email: melissal@drcmr.dk

\*\* These authors contributed equally to the study

Word count: Abstract: 241 words; Text body: 4700 words.

## Abstract

**Background.** The 22q11.2 deletion syndrome confers a markedly increased risk for schizophrenia. 22q11.2 deletion carriers without manifest psychotic disorder offer the possibility to identify functional abnormalities that precede clinical onset. Since schizophrenia is associated with a reduced cortical gamma response to auditory stimulation at 40 Hz, we hypothesized that the 40 Hz auditory steady-state response (ASSR) may be attenuated in non-psychotic individuals with a 22q11.2 deletion.

**Methods.** 18 young non-psychotic 22q11.2 deletion carriers and an control group of 27 non-carriers with comparable age range (12-25 years) and sex ratio underwent 128-channel EEG. We recorded the cortical ASSR to a 40 Hz train of clicks, given either at a regular inter-stimulus interval of 25 ms or at irregular intervals jittered between 11 and 37 ms.

**Results.** Healthy non-carriers expressed a stable ASSR to regular but not in the irregular 40 Hz click stimulation. Both gamma power and inter-trial phase coherence of the ASSR were markedly reduced in the 22q11.2 deletion group. The ability to phase lock cortical gamma activity to regular auditory 40 Hz stimulation correlated with the individual expression of negative symptoms in deletion carriers ( $\rho = -0.487$ ,  $p = 0.041$ ).

**Conclusions.** Non-psychotic 22q11.2 deletion carriers lack efficient phase locking of evoked gamma activity to regular 40 Hz auditory stimulation. This abnormality indicates a dysfunction of fast intracortical oscillatory processing in the gamma-band. Since ASSR was attenuated in non-psychotic deletion carriers, ASSR deficiency may constitute a pre-morbid risk marker of schizophrenia.

Keywords: 22q11.2 Deletion Syndrome, Gamma band, EEG, Oscillations, Schizophrenia

## Introduction

The 22q11.2 deletion is the most common copy number variant in humans with an estimated prevalence of 1:2000 to 1:4000<sup>1-3</sup>. 22q11.2 deletions are associated with a highly variable clinical phenotype, including a range of somatic disorders, learning problems, cognitive deficits<sup>4,5</sup> and hearing loss<sup>6</sup>. Individuals carrying a 22q11.2 deletion have an increased risk of developing schizophrenia and other psychiatric disorders such as autism spectrum disorder and attention deficit hyperactivity disorder<sup>7-9</sup>. According to the International Consortium on Brain and Behavior in 22q11.2 Deletion Syndrome (22q11.2DS), the prevalence of schizophrenia-spectrum disorder is 24% in adolescent and 41% in adult 22q11.2 carriers<sup>8</sup>. A recent nationwide Danish Registry study showed that the risk of developing a schizophrenia-spectrum disorder in individuals previously diagnosed with 22q11.2DS was approximately eight times higher than in the general population<sup>10</sup>. Since the 22q11.2DS confers a substantial risk for schizophrenia, the identification of neurophysiologic abnormalities in non-psychotic 22q11.2 deletion carriers may reveal important insights into the pathogenesis of schizophrenia and assist the search of early markers. Investigations of high-risk groups are very appealing from a clinical perspective as they not only can provide a better knowledge of the disease evolution, but potentially can lead to strategies for prevention or early treatment.

Auditory steady-state responses (ASSRs) evoked by brief tones or clicks at a repetition rate of 40 Hz provide a readily available, non-invasive means of probing impaired neural gamma synchrony in the auditory system<sup>11</sup>. A seminal ASSR study showed that the ASSR was selectively reduced in patients with schizophrenia when auditory stimulation was applied at 40 Hz, but not at 20 Hz or 30 Hz<sup>12</sup>. Later studies reported reduced expression and phase locking of steady-state gamma

1  
2  
3  
4 oscillations in patients with schizophrenia<sup>13–16</sup>. A recent meta-analysis concludes that decreased  
5  
6 40 Hz ASSR is a robust finding in schizophrenia<sup>17</sup>. The ASSR is further observed reduced in first-  
7  
8 episode psychosis<sup>18,19</sup>, as well as in non-affected first degree relatives<sup>20,21</sup>. So far, there have been  
9  
10 no studies looking at ASSR in 22q11.2DS. However, one study has shown reduced ASSR in an ultra-  
11  
12 high-risk group (UHR)<sup>22</sup>, where subjects who met criteria for attenuated psychotic symptoms, brief  
13  
14 intermittent psychotic symptoms and genetic risk deterioration were included in the study based  
15  
16 on the structured interview for prodromal symptoms (SIPS).  
17

18  
19 Linking ASSR and clinical symptoms in schizophrenia, inter-trial phase coherence (ITPC) has shown  
20  
21 to be positive correlated with the presence of positive symptoms<sup>19</sup>. The same group also reported  
22  
23 a positive correlation between left-hemispheric ITPC and the expression of auditory  
24  
25 hallucination<sup>15</sup>. Moreover, a negative correlation between the ASSR amplitude at 80 Hz and  
26  
27 negative symptoms has been shown<sup>23</sup>. In the UHR-study<sup>22</sup>, the power of the ASSR at 40 Hz was  
28  
29 negatively correlated with the individual PANSS scores for positive symptoms, but not for negative  
30  
31 symptoms.  
32  
33

34  
35 In schizophrenia, impaired neural processing in cortical circuits has been attributed to  
36  
37 dysfunctional oscillatory cortical activity in the gamma-band (30–100 Hz) and underlying  
38  
39 abnormalities in GABAergic and glutamatergic neurotransmission<sup>12,24–26</sup>. Cortical gamma  
40  
41 oscillations rely on the integrity of fast-spiking GABAergic interneurons which exert a finely timed  
42  
43 inhibition onto the pyramidal cells and other inhibitory interneurons<sup>27–29</sup>. Disturbed interactions of  
44  
45 these circuits are thought to critically contribute to pathogenesis and cognitive impairment in  
46  
47 schizophrenia<sup>30,31</sup>. In agreement with the notion of a GABAergic dysfunction, magnetic  
48  
49 resonance spectroscopy revealed that gamma-aminobutyric acid (GABA) levels in visual cortex are  
50  
51 reduced by 13% in patients with schizophrenia as compared to healthy controls<sup>32</sup>. Likewise,  
52  
53  
54  
55  
56  
57  
58  
59  
60

1  
2  
3  
4 prefrontal GABA levels were reduced in patients with schizophrenia as compared to controls using  
5  
6 magnetic resonance spectroscopy at 7 T<sup>33</sup>. Accordingly, post-mortem studies of 22q11.2 carriers  
7  
8 have shown reduced levels of GABA<sup>34</sup> at sites of cortical malfunction. Recent studies have  
9  
10 provided converging evidence that cortical gamma oscillatory activity critically depend on the  
11  
12 function of N-methyl-D-aspartate (NMDA) receptors located on parvalbumin-positive, fast-spiking,  
13  
14 GABAergic interneurons<sup>35-40</sup>. The emerging links between abnormal cortical gamma oscillatory  
15  
16 activity and specific cellular and subcellular mechanisms constitute a potential target for future  
17  
18 treatments of schizophrenia<sup>24,28,41</sup>.

19  
20  
21  
22  
23 In murine models of 22q11.2DS, a disruption of glutamatergic synaptic transmission within the  
24  
25 auditory cortex has been found<sup>42</sup>. Further, in a mouse model of 22q11.2DS increased acoustic  
26  
27 startle response as well as pre-pulse inhibition (PPI) deficits was found<sup>43</sup>. Since no difference in  
28  
29 auditory brain stem responses were found, the deficits in PPI could not account for this. One study  
30  
31 investigated auditory gating in 22q11.2DS<sup>44</sup>. While P50 was found to be normal, 22q11.2DS  
32  
33 carriers showed increased amplitudes of the first N1 component at central electrodes, suggesting  
34  
35 abnormal higher order processing.  
36  
37  
38  
39

40  
41 Using a neurogenetically informed approach, we recorded the ASSR in non-psychotic carriers of a  
42  
43 22q11.2 deletion and healthy controls without such deletion with comparable age range and sex  
44  
45 ratio. The auditory stimulation was applied regularly and irregularly, testing whether temporal  
46  
47 regularity of the 40 Hz train was critical to evoke ASSR. In this way we could test for differences in  
48  
49 steady state as well as transient (non-steady state) responses. We expected that the 22q11.2  
50  
51 deletion carriers express a reduced cortical gamma response to regular auditory stimulation at 40  
52  
53 Hz as a potential risk marker of schizophrenia, showing a reduction in power and reduced phase  
54  
55  
56  
57  
58  
59  
60

1  
2  
3  
4 synchronization of the ASSR relative to healthy non-carriers. Further, we expected the response to  
5  
6 irregular stimulation to be matched between groups. We further explored whether the ASSR  
7  
8 alterations in 22q11.2 deletion carriers were correlated with symptom severity.  
9

## 10 11 12 13 14 15 16 **Methods and Materials**

### 17 18 **Subjects**

19  
20  
21 18 young individuals 12 to 25 years with a verified 3 MB deletion at chromosome 22q11.2 and 27  
22  
23 healthy individuals without a 22q11.2 deletion participated in the study. Groups were comparable  
24  
25 with respect to sex ratio (controls: 18 males and 9 females, carriers: 13 males and 5 females,  $\chi^2 =$   
26  
27 0.54,  $p = 0.46$ ) and age distribution (controls: mean age = 15.96 years, standard deviation (SD) =  
28  
29 2.71 years; carriers: mean age = 15.39 years, SD = 2.45 years,  $t_{43} = 0.72$   $p = 0.47$ ). All participants  
30  
31 were evaluated for the presence of current psychiatric disorders and diagnoses were given  
32  
33 according to the ICD-10 diagnostic system if clinical criteria were met. For more information on  
34  
35 diagnose criteria, see supplementary material. Carriers of the 22q11.2 deletion with a known  
36  
37 history of schizophrenia were excluded. The Structured Interview for Prodromal Syndromes  
38  
39 (SIPS)<sup>45,46</sup> was used to rate the severity of: positive, negative, disorganized, and general symptoms,  
40  
41 see supplementary materials for detailed information.  
42  
43  
44  
45  
46  
47

48 The following exclusion criteria were applied to controls: a) schizophrenia, schizotypal and  
49  
50 delusional disorders (ICD10 DF20-29); b) bipolar disorder (ICD10 DF30-31); c) depression (ICD10  
51  
52 DF32-33) except for a past episode of mild or moderate depression (ICD10 DF 32.0 or 32.1); d)  
53  
54 substance abuse; or e) a first degree relative with a psychotic illness. All participants underwent a  
55  
56  
57  
58  
59  
60



1  
2  
3  
4 verbal and written informed consent process. Participants under the age of 18 provided a verbal  
5  
6 assent while their parent's completed written consent. The study was approved by the Regional  
7  
8 Ethical Committee of Copenhagen (project id: H-3-2012-136) and the Danish Data protection  
9  
10 Agency (project id: 2007-58-0015). All participants are part of a larger nationwide study and  
11  
12 underwent extended cognitive, genetic and clinical testing, described in detail by Schmock et al.  
13  
14 (2015)<sup>47</sup>. Since 22q11.2DS is associated with hearing loss, audiometric testing was performed prior  
15  
16 to the experiment to confirm that participants were able to hear the click stimuli (20dB random  
17  
18 test Oscilla USB-310 Tablet screening audiometer, Aarhus, Denmark), see supplementary materials  
19  
20  
21 for more details.  
22  
23  
24

### 25 26 **ASSR paradigm**

27  
28 To evoke steady-state gamma activity, subjects were presented with a train of short clicks  
29  
30 delivered at a mean click-repetition frequency of 40 Hz<sup>12</sup>. Each click lasted 1 ms and each click  
31  
32 train lasted 1 s, followed by a pause of 2 s, resulting in a stimulus onset asynchrony of 3 s (Figure  
33  
34 1). The stimuli were delivered binaurally via insert-earphones at a sound pressure level of 85 dB (E-  
35  
36 A-RTONE 3A Indianapolis, US), using the MatLab-based Cogent 2000 toolbox as presentation  
37  
38 software ([http://www.vislab.ucl.ac.uk/cogent\\_2000.php](http://www.vislab.ucl.ac.uk/cogent_2000.php)). We used an external soundcard (RME  
39  
40 Babyface 22-Channel, 192kHz Bus-powered, Haimhausen, Germany). During ASSR recording,  
41  
42 subjects sat in a comfortable chair, were instructed to relax and to constantly look at a fixation  
43  
44 cross on the screen in front of them without paying particular attention to the sounds.  
45  
46  
47

48  
49 We applied regular and irregular 40 Hz trains. In the regular condition, clicks had a constant inter-  
50  
51 click interval of 25 ms (i.e. regular 40 Hz train). In the irregular condition, the inter-click interval  
52  
53 was randomly jittered between 11 and 37 ms while maintaining a mean click frequency of 40 Hz.  
54  
55  
56 We introduced this condition to record the cortical response evoked by click stimulation that was  
57  
58  
59  
60

1  
2  
3  
4 matched for all acoustic features except regularity. Thus, the irregular condition served as a  
5  
6 control condition testing whether the temporal regularity of the 40 Hz train was critical to evoke  
7  
8 abnormal auditory cortical processing restricted to ASSR. The temporal structure of the irregular  
9  
10 click train was kept constant within subjects, but changed randomly across subjects. For regular  
11  
12 and irregular 40 Hz stimulation, ASSR were recorded in two separate runs, consisting of 120 trials  
13  
14 (Figure 1). A single run lasted six minutes.  
15  
16  
17

### 18 **EEG recordings and pre-processing**

19  
20 EEG data was recorded using a 128 channel ActiveTwo Biosemi System (BioSemi, Amsterdam,  
21  
22 Netherlands) at a sampling frequency of 4096 Hz. Pre-processing and analysis were carried out  
23  
24 using the fieldtrip toolbox<sup>48</sup>. The preprocessing steps consisted of: referencing to the average of  
25  
26 the two mastoids, band-pass filtering using the interval [1-130] Hz, notch filtering using the  
27  
28 interval [48-52] Hz to attenuate 50 Hz line noise, down-sampling to 1024 Hz, and finally epoching  
29  
30 with a peri-stimulus window of -1000ms to 2000ms. Epochs were baseline corrected using the  
31  
32 average over the time window -1000ms to -300ms. Artifact removal was performed using a simple  
33  
34 threshold approach where epochs were rejected if their values exceeded  $\pm 100 \mu\text{V}$ . No channels  
35  
36 were discarded.  
37  
38  
39  
40  
41  
42

### 43 **Time-frequency analysis**

44  
45 The epoched data were wavelet-transformed using a Complex Morlet wavelet with 12 cycles, as  
46  
47 implemented in the Fieldtrip toolbox<sup>48</sup>. The frequency band of interest covered frequencies from  
48  
49 10 to 60 Hz at 1Hz resolution. The inter-trial phase coherence (ITPC) and power were extracted  
50  
51 from the wavelet coefficients.. The amplitude of the ITPC reflects the phase consistency across  
52  
53 trials for a given channel, time and frequency point and can take values between 0 (no phase  
54  
55  
56  
57  
58  
59  
60

1  
2  
3  
4 consistency) and 1 (perfect phase consistency). The ITPC and power amplitude as recorded from  
5  
6 Cz were averaged in the 300-700ms time window of auditory stimulation over the frequencies 36-  
7  
8 44 Hz.  
9

### 10 11 **Statistical analysis**

12  
13 Two Sample t-test and Wilcoxon rank sum test was used to test for case-control differences in IQ  
14  
15 and the four domain scores obtained from the SIPS interview, respectively. Group differences in  
16  
17 ASSR were assessed using a hypothesis-driven approach testing for differences in raw ITPC  
18  
19 amplitude as well as power values between groups from one single EEG channel (Cz according to  
20  
21 the international 10-20-system, see Figure 2 where channel Cz is marked). We chose Cz because  
22  
23 we had *a priori* knowledge that the sensors of the mid-central regions express the highest gamma  
24  
25 response to regular click stimulation at 40 Hz<sup>49</sup>. Two separate repeated-measures analysis of  
26  
27 covariance (rm-ANCOVA) were therefore computed with ITPC or power as dependent variables.  
28  
29 The rm-ANCOVA included the factors group (two levels: deletion carriers and non-carriers) and the  
30  
31 within-subject factor condition (two levels: regular and irregular), as well as age and sex as  
32  
33 covariates. We post-hoc added hearing thresholds observed as a mean over frequencies from the  
34  
35 20dB random test as covariate. Information regarding post-hoc test for diagnosis and IQ can be  
36  
37 found in the supplementary material.  
38  
39  
40  
41  
42  
43  
44

45  
46 Greenhouse-Geisser correction for non-sphericity was applied if necessary. Follow-up t-tests were  
47  
48 performed for significant interactions. If equality of variance where not met (assessed with  
49  
50 Levene's test), separate variance t-tests were performed when necessary. Bonferroni correction  
51  
52 for multiple comparisons was applied if necessary and significance levels were corrected  
53  
54 accordingly.  
55  
56  
57  
58  
59  
60

1  
2  
3  
4 Two subjects belonging to the 22q11.2 group completed only the regular condition because of  
5 exhaustion after this session. One healthy non-carrier had to be discarded from the regular  
6 condition due to problems with the trigger. The results are thus based on the ASSR of 18 deletion  
7 carriers for the regular condition, 16 deletion carriers for the irregular condition, 26 healthy non-  
8 carriers for the regular condition and 27 healthy non-carriers for the irregular condition. For the  
9 rm-ANCOVA the results are based on 16 deletion carriers and 26 non-deletion carriers.  
10  
11  
12  
13  
14  
15  
16  
17

18 Non-parametric Spearman's rank correlations analysis was performed to test for correlations  
19 between individual ASSR measures and negative symptoms score. Only correlations with negative  
20 symptoms were carried out since the presentation of positive, disorganized and generalized  
21 symptoms were skewed in the present group (5 out of 18 (28%) of the 22q11.2 deletion carriers  
22 had a score of 0 in the positive symptoms, 5 out of 18 (28%) in the disorganized and 11 out of 18  
23 (61%) in generalized symptoms). For all analyses, significance threshold was set at  $p < 0.05$ .  
24  
25  
26  
27  
28  
29  
30  
31  
32

### 33 Results

34 The 22q11.2DS group had an IQ (median = 82.0, 90<sup>th</sup> percentile = 94.8, 10<sup>th</sup> percentile = 63.6) that  
35 was significantly lower than the IQ in the control group (median = 108.0, 90<sup>th</sup> percentile = 127, 10<sup>th</sup>  
36 percentile = 95.2,  $t_{43} = -7.05$ ,  $p < 0.001$ ). The included raw sum of negative symptoms for the  
37 22q11.2 carriers ranged from 1 to 16 (mean = 7 and SD = 3.5), from 0 to 12 for positive symptoms  
38 (mean = 2.7, SD = 3.1), from 0 to 6 for disorganized (mean = 1.8, SD = 1.8) and from 0 to 7 for  
39 generalized symptoms (mean = 1.0, SD = 1.9).  
40  
41  
42  
43  
44  
45  
46  
47  
48  
49

50 Within the 22q11.2 deletion carriers, one was diagnosed with affective disorder, two with  
51 disturbance of activity/attention deficit disorder without hyperactivity, six with anxiety or phobia  
52 and one with both autism spectrum disorder and anxiety or phobia. None of the participants had  
53  
54  
55  
56  
57  
58  
59  
60

1  
2  
3  
4 psychosis, but the 22q11.2DS cohort had significantly elevated raw SIPS scores for negative ( $W =$   
5  
6 477,  $p < 0.001$ ), positive ( $W = 350.5$ ,  $p = .008$ ), disorganized ( $W = 404$ ,  $p < 0.001$ ) and generalized  
7  
8 ( $W = 312.5$ ,  $p = .027$ ) symptoms, relative to the control group. 15 of the 22q11.2 deletion carriers  
9  
10 had negative symptoms within the attenuated level (3-5) in one or more of the negative  
11  
12 symptoms categories, but only three individuals had one or more psychotic and/or disorganized  
13  
14 symptoms within the attenuated level. Generalized symptoms at the attenuated level were only  
15  
16 seen in two of the 22q11.2 deletion carriers. Apart from one subject taking 20 mg of retalin, none  
17  
18 of the carriers took medication acting on the central nervous system.  
19  
20  
21

22 The 20 dB random test, revealed that subjects were able to detect the tones used for eliciting  
23  
24 ASSR. Across frequencies the observed threshold levels were (mean = 20.5, SD = 0.7) for controls  
25  
26 and (mean = 24.6, SD = 3.6) for 22q11.2. In two 22q11.2 deletion carriers, the dB level of the click  
27  
28 trains was decreased from 85 dB to 80 dB because they reported that the stimulus was  
29  
30 uncomfortable at 85 dB.  
31  
32

33 Mean ITPC and power frequency plots of the ASSR for healthy 22q11.2 deletion carriers and non-  
34  
35 carriers are shown in Figure 2 A and B respectively. Healthy controls without a 22q11.2 deletion  
36  
37 showed a clearly discernible ASSR at around 40 Hz which was temporally confined to the time of  
38  
39 regular click stimulation (Figure 2). This response critically relied on the regularity of the 40 Hz  
40  
41 acoustic train, because jittering the frequency around 40 Hz, as expected reduced the ASSR (Figure  
42  
43 2 and Figure 3). Non-psychotic carriers showed a clear attenuation of the ASSR to regular 40 Hz  
44  
45 click stimulation (Figure 2 and Figure 3) when comparing to the healthy non-carriers. The response  
46  
47 to the irregular 40 Hz click train stimulation was similar in both groups.  
48  
49  
50  
51  
52  
53  
54  
55  
56  
57  
58  
59  
60

### Inter-trial phase coherence

Repeated-measures-ANCOVA revealed that mean ITPC across the two conditions was significantly lower for the 22q11.2 group compared to the non-carrier group ( $F_{1,38} = 7.1$ ,  $p = 0.011$ , Figure 3A). Moreover, we observed a significant effect of condition ( $F_{1,38} = 6.3$ ,  $p = 0.016$ ), showing that the regular condition was overall much more effective than the irregular. There was no significant group-by-condition interaction ( $F_{1,38} = 2.4$ ,  $p = 0.127$ ). Overall the mean value of ITPC in the regular condition was reduced by 28% in the deletion carriers compared to the non-carriers and by 21% in the irregular condition (Figure 3A). ITPC decreased with age ( $F_{1,38} = 6.4$ ,  $p = 0.016$ ) and age showed a significant interaction with condition ( $F_{1,38} = 4.7$ ,  $p = 0.037$ ) attributable by younger participants having a higher ITPC score in the regular condition compared to older participants while younger and older participants showed similar values for the irregular condition. No effect of sex ( $F_{1,38} = 2.0$ ,  $p = 0.169$ ) or interaction (condition-by-sex,  $F_{1,38} = 1.6$ ,  $p = 0.209$ ) was observed. Adding hearing threshold as covariates the group effect did not change significance.

### Power

Repeated-measures-ANCOVA also showed a significant group difference in power ( $F_{1,38} = 7.6$ ,  $p = 0.009$ ) which reflected a relative reduction of the ASSR power in deletion carriers (Figure 3B). There was also a main effect for condition ( $F_{1,38} = 4.6$ ,  $p = 0.038$ ) and a significant interaction between group and condition ( $F_{1,38} = 6.1$ ,  $p = 0.018$ ) which was due to a stronger decrease in power for the regular condition in deletion carriers relative to non-carriers (Figure 3B). Post-hoc pair-wise comparisons confirmed that 22q11.2 deletion carriers had a lower power for the regular condition as compared to healthy non-carriers ( $t_{40} = 2.4$ ,  $p = 0.022$ ,  $\alpha = 0.025$ ), while power did not differ from healthy non-carriers in the irregular condition ( $t_{40} = 2.9$ ,  $p = 0.770$ ). Overall the mean value of power

1  
2  
3  
4 in the regular condition was reduced by 24% in the deletion carriers compared to the non-carriers,  
5  
6 but only by 4% in the irregular condition.  
7  
8

9  
10 We also found a significant effect for age with lower ASSR power at higher age ( $F_{1,38} = 5.7$ ,  $p =$   
11  
12  $0.022$ ). The age effect interacted with condition ( $F_{1,38} = 5.3$ ,  $p = 0.027$ ). Inspection of the individual  
13  
14 data revealed that younger participants expressed a higher power in the regular condition  
15  
16 compared to older participants, while power was not influenced by age in the irregular condition.  
17  
18 There was no effect of sex ( $F_{1,38} = 0.8$ ,  $p = 0.368$ ) or interaction between sex and condition  
19  
20 observed ( $F_{1,38} = 1.2$ ,  $p = 0.283$ ).  
21  
22  
23

24 For post-hoc tests on diagnosis and IQ, see supplementary material.  
25  
26  
27  
28  
29  
30

### 31 **Correlation with negative symptoms**

32  
33 In carriers with a 22q11.2 deletion, individual ITPC for the regular condition showed a negative  
34  
35 correlation with the individual SIPS scores of negative symptoms (Spearman:  $\rho = -0.487$ ,  $p =$   
36  
37  $0.041$ ). The correlation remained significant after including age as covariate ( $\rho = -0.493$ ,  $p = 0.045$ ).  
38  
39 For comparison, we also calculated the correlation between ITPC for the irregular condition and  
40  
41 negative symptom scores and found no correlation ( $\rho = -0.146$ ,  $p = 0.591$ ). No correlation was  
42  
43 found between ASSR power and negative symptom scores (Spearman:  $\rho = -0.245$ ,  $p = 0.326$ ).  
44  
45  
46  
47  
48

### 49 **Discussion**

50 This study, to our knowledge, provides first-time evidence that the cortical steady-state response  
51  
52 to auditory 40 Hz stimulation is impaired in a genetically defined group with a markedly increased  
53  
54 risk for schizophrenia. In non-psychotic 22q11.2 deletion carriers, the gamma power of the ASSR  
55  
56  
57  
58  
59  
60

1  
2  
3  
4 was significantly reduced by 24% during regular 40 Hz click stimulation relative to healthy controls  
5  
6 without 22q11.2 deletion. We further detected a reduced phase precision of the ASSR in non-  
7  
8 psychotic 22q11.2 deletion carriers who showed on average a relative reduction of 28% in trial-to-  
9  
10 trial phase synchronization as compared to the control group. The ability to phase lock the  
11  
12 auditory evoked gamma activity to the 40 Hz click train stimulation was negatively correlated with  
13  
14 the negative symptom scores of the 22q11.2 carriers. The results confirm and extend previous  
15  
16 ASSR studies in non-psychotic first-degree relatives of patients with schizophrenia<sup>20,21</sup>. Together,  
17  
18 these findings show that a deficient ASSR may be a useful premorbid risk marker for  
19  
20 schizophrenia. In carriers with a 22q11.2 deletion, reduced trial-to-trial phase synchronization  
21  
22 correlated with the presence of elevated negative symptoms. Since negative symptoms represent  
23  
24 an important facet of the symptomatology in schizophrenia these findings corroborate the notion  
25  
26 that abnormal synchronization of gamma-band activity may play an important role in the  
27  
28 generation of the negative symptoms in schizophrenia.  
29  
30  
31  
32

33  
34 GABA<sub>A</sub> receptor-mediated inhibition plays a substantial role in the underlying mechanisms of  
35  
36 gamma oscillations<sup>50</sup>. GABA-mediated inhibition results in decreased gamma oscillations and  
37  
38 cognitive impairment, for a review see<sup>30,51</sup>. Recent studies in rodents point to a critical functional  
39  
40 role of NMDA receptors located on fast-spiking parvalbumin positive, GABAergic  
41  
42 interneurons<sup>39,40,52,53</sup> in the generation of cortical gamma oscillations, suggesting that the ASSR  
43  
44 may be used as biomarker for cortical NMDA function<sup>37</sup>.  
45  
46  
47  
48

49 The ASSR is reduced in schizophrenia<sup>14-16</sup> as well as in first-episode psychosis<sup>18,19</sup>. This might be  
50  
51 caused by a reduced concentration of GABA or dysfunctional GABA release<sup>24,54</sup> or a dysfunction of  
52  
53 the NMDA receptors controlling the fast-spiking GABAergic interneurons<sup>55</sup>. In addition,  
54  
55 electrophysiological findings have indicated that evoked gamma power increases during  
56  
57  
58  
59  
60



1  
2  
3  
4 childhood and adolescence<sup>56-58</sup>. It is thus believed that neural synchrony continues to develop  
5  
6 until early adulthood<sup>58</sup>, which might be linked to a gradual developmental switch in expression of  
7  
8 the gamma-1 relative to the gamma-2 subunit of the GABA receptors, causing a more rapid and  
9  
10 precise inhibition of pyramidal target cells<sup>59</sup>. It therefore remains to be clarified, whether the  
11  
12 abnormal ASSR in 22q11.2 deletion carriers is caused by a GABA-related or NMDA receptor related  
13  
14 dysfunction or both.  
15  
16

17  
18 Although we speculate that the present finding of a reduced ASSR in 22q11.2 deletion carriers  
19  
20 could be due to a reduced level of GABA as observed in schizophrenia, 22q11.2DS results in a wide  
21  
22 range of neurobiological abnormalities. Other neurobiological sequelae, such as hearing loss<sup>6</sup>,  
23  
24 PRODH deletion effects on glutamatergic transmission<sup>60</sup>, and ZDHHC8 deletion effects on  
25  
26 development of neural function<sup>60,61</sup>, might also affect the ASSR in 22q11.2 deletion carriers. At  
27  
28 variance with two previous reports<sup>56,57</sup>, we found that the power and ITPC of ASSR decreased with  
29  
30 age. However the age range in the present study (12-25 years, with the majority being between  
31  
32 12-18 years) differs markedly from the age ranges in previous reports. In one study, three groups  
33  
34 were tested at an age of 10, 11.5 and 19-45 years<sup>56</sup>. In a MEG study on the age effect on ASSR, age  
35  
36 distribution was large, ranging from 5-52 years<sup>57</sup>. Since our statistical analysis revealed group  
37  
38 differences in ITPC and power in a model that controlled for the effect of age, the observed  
39  
40 abnormality in ASSR in deletion carriers cannot be attributed to the age of our participants. Since  
41  
42 it can be expected that a proportion of 22q11.2 carriers will develop schizophrenia at a later time  
43  
44 in life<sup>8</sup>, repeated measurements of ASSR in the same subjects during adolescence and early  
45  
46 adulthood might provide more fine-grained insights into age-related developmental trajectories of  
47  
48 ASSR abnormalities and their relation to the clinical manifestation of schizophrenia.  
49  
50  
51  
52  
53  
54  
55  
56  
57  
58  
59  
60

1  
2  
3  
4 The reduction of ITPC in 22q11.2 deletion carriers was observed across the two conditions; regular  
5  
6 and irregular. However, the reduction of power was observed only in the regular condition. This is  
7  
8 an interesting finding, showing that even transient gamma responses during irregular broad-band  
9  
10 gamma stimulation are less efficiently aligned in deletion carriers. ITPC correlated negatively with  
11  
12 the negative symptoms of the 22q11.2 deletion carriers. However, given the exploratory nature of  
13  
14 the correlational analyses and the relatively small sample size this finding should be considered  
15  
16 preliminary and needs to be replicated in larger studies before any strong conclusions can be  
17  
18 drawn. The small sample size of non-psychotic 22q11.2 deletion carriers is a limitation of the  
19  
20 study. The abnormalities in ASSR found in 18 deletion carriers warrant replication in larger  
21  
22 cohorts.  
23  
24  
25  
26

27  
28 In conclusion, this study presents first time evidence that young non-psychotic 22q11.2 carriers  
29  
30 lack the auditory steady state gamma response. This highlights the emerging importance of  
31  
32 gamma-band oscillations in understanding the neurophysiological characteristics of schizophrenia.  
33  
34 Further, the observed results in a non-psychotic high risk group indicate that dysfunctional gamma  
35  
36 responses from an auditory steady state gamma paradigm could potentially serve as an early risk  
37  
38 marker for schizophrenia if confirmed by longitudinal studies. Reliable functional risk markers that  
39  
40 can support early diagnostics may assist clinical decision-making for targeted therapy. This is  
41  
42 relevant because recent results found a positive effect of early treatment on clinical and function  
43  
44 status<sup>62,63</sup>.  
45  
46  
47  
48  
49  
50

## 51 **Acknowledgements**

52 We would like to thank all the participant 22q11DS and families for taking the time to participate  
53  
54 in our study and the Danish National Association for their strong support of our work. We highly  
55  
56  
57  
58  
59  
60

1  
2  
3  
4 appreciate the efforts of Anders Vangkilde and Henriette Schmock for their dedicated assistance in  
5  
6 the recruitment and clinical assessments. A thanks to Lars Ewald for technical support.. We would  
7  
8 also like to express our gratitude to the staff involved in the Danish Blood Donor Study, Capital  
9  
10 Region Blood bank, Glostrup as well as <http://www.forsogsperson.dk/>.

11  
12  
13 This study was funded by the Lundbeck Foundation, Denmark (R155-2014-1724); Lundbeck  
14  
15 Foundation [Grant of Excellence "ContAct" R59 A5399]; Lundbeck Foundation fellowship (R105-  
16  
17 9813); The Capital Region's Research Foundation for Mental Health Research.

### 21 22 **Financial disclosures**

23  
24 H.R.S. received honoraria as speaker from Lundbeck A/S, Valby, Denmark, Biogen Idec, Denmark  
25  
26 A/S, Genzyme, Denmark and MerckSerono, Denmark, honoraria as editor from Elsevier Publishers,  
27  
28 Amsterdam, The Netherlands and Springer Publishing, Stuttgart, Germany, travel support from  
29  
30 MagVenture, Denmark, and grant support from Biogen Idec, Denmark A/S. M.R.B is a prior  
31  
32 employee at H. Lundbeck A/S, Denmark and received financial support for her PhD from the  
33  
34 Innovation Fund Denmark. M.D is employed with Lundbeck A/S. The authors declare no further  
35  
36 biomedical financial interests or potential conflicts of interest.

37  
38  
39 This article is distributed under the Danish legislation governed by the Privacy Act (act# 429,  
40  
41 31/05/2000), which does not permit data sharing at publicly available repositories or in raw  
42  
43 formats. Summary statistics can be obtained through contact with the corresponding author  
44  
45  
46  
47  
48 ([melissal@drcmr.dk](mailto:melissal@drcmr.dk)).

## References

1. Oskarsdóttir S, Vujic M, Fasth A. Incidence and prevalence of the 22q11 deletion syndrome: a population-based study in Western Sweden. *Arch Dis Child*. 2004;89(2):148-151.
2. Goodship J, Cross I, LiLing J, Wren C. A population study of chromosome 22q11 deletions in infancy. *Arch Dis Child*. 1998;79(4):348-351.
3. Robert J. Shprintzen. Management of genetic syndromes. In: Cassidy, S., & Allanson JE, ed. Vol 2. ed. New York: Hoboken, N.J.: J. Wiley; 2005:615-632.
4. Robin NH, Shprintzen RJ. Defining the clinical spectrum of deletion 22q11.2. *J Pediatr*. 2005;147(1):90-96. doi:10.1016/j.jpeds.2005.03.007.
5. Karayiorgou M, Simon TJ, Gogos J a. 22q11.2 microdeletions: linking DNA structural variation to brain dysfunction and schizophrenia. *Nat Rev Neurosci*. 2010;11(6):402-416. doi:10.1038/nrn2841.
6. Jiramongkolchai P, Kumar MS, Chinnadurai S, Wootten CT, Goudy SL. Prevalence of hearing loss in children with 22q11.2 deletion syndrome. *Int J Pediatr Otorhinolaryngol*. 2016;87:130-133. doi:10.1016/j.ijporl.2016.06.005.
7. Bassett AS, Marshall CR, Lionel AC, Chow EWC, Scherer SW. Copy number variations and risk for schizophrenia in 22q11.2 deletion syndrome. *Hum Mol Genet*. 2008;17(24):4045-4053. doi:10.1093/hmg/ddn307.
8. Schneider M, Debbané M, Bassett AS, et al. Psychiatric disorders from childhood to

- 1  
2  
3  
4 adulthood in 22q11.2 deletion syndrome: results from the International Consortium on  
5  
6 Brain and Behavior in 22q11.2 Deletion Syndrome. *Am J Psychiatry*. 2014;171(6):627-639.  
7  
8 doi:10.1176/appi.ajp.2013.13070864.  
9
- 10  
11  
12 9. Purcell SM, Wray NR, Stone JL, et al. Common polygenic variation contributes to risk of  
13  
14 schizophrenia and bipolar disorder. *Nature*. 2009;460(7256):748-752.  
15  
16 doi:10.1038/nature08185.  
17  
18  
19  
20 10. Vangkilde A, Olsen L, Hoeffding LK, et al. Schizophrenia Spectrum Disorders in a Danish  
21  
22 22q11.2 Deletion Syndrome Cohort Compared to the Total Danish Population—A  
23  
24 Nationwide Register Study. *Schizophr Bull*. 2016;42(3):824-831. doi:10.1093/schbul/sbv195.  
25  
26  
27  
28 11. Plourde G, Stapells DR, Picton TW. The Human Auditory Steady-State Evoked Potentials.  
29  
30 *Acta Otolaryngol*. 1991;111(sup491):153-160. doi:10.3109/00016489109136793.  
31  
32  
33 12. Kwon JS, O'Donnell BF, Wallenstein G V, et al. Gamma frequency-range abnormalities to  
34  
35 auditory stimulation in schizophrenia. *Arch Gen Psychiatry*. 1999;56(11):1001-1005.  
36  
37  
38  
39 13. Light G a., Hsu JL, Hsieh MH, et al. Gamma band oscillations reveal neural network cortical  
40  
41 coherence dysfunction in schizophrenia patients. *Biol Psychiatry*. 2006;60(11):1231-1240.  
42  
43 doi:10.1016/j.biopsych.2006.03.055.  
44  
45  
46 14. Krishnan GP, Hetrick WP, Brenner CA, Shekhar A, Steffen AN, O'Donnell BF. Steady state and  
47  
48 induced auditory gamma deficits in schizophrenia. *Neuroimage*. 2009;47(4):1711-1719.  
49  
50 doi:10.1016/j.neuroimage.2009.03.085.  
51  
52  
53  
54 15. Spencer KM, Niznikiewicz MA, Nestor PG, Shenton ME, McCarley RW. Left auditory cortex  
55  
56 gamma synchronization and auditory hallucination symptoms in schizophrenia. *BMC*  
57  
58  
59  
60

- 1  
2  
3  
4 *Neurosci.* 2009;10(1):85. doi:10.1186/1471-2202-10-85.  
5  
6  
7  
8 16. Brenner CA, Sporns O, Lysaker PH, O'Donnell BF. EEG synchronization to modulated  
9 auditory tones in schizophrenia, schizoaffective disorder, and schizotypal personality  
10 disorder. *Am J Psychiatry.* 2003;160(12):2238-2240. doi:10.1176/appi.ajp.160.12.2238.  
11  
12  
13  
14  
15 17. Thuné H, Recasens M, Uhlhaas PJ. The 40-Hz Auditory Steady-State Response in Patients  
16 With Schizophrenia: A Meta-analysis. *JAMA psychiatry.* October 2016.  
17  
18 doi:10.1001/jamapsychiatry.2016.2619.  
19  
20  
21  
22  
23 18. Symond MP, Symond MB, Harris AWF, Gordon E, Williams LM. "Gamma synchrony" in first-  
24 episode schizophrenia: a disorder of temporal connectivity? *Am J Psychiatry.*  
25  
26 2005;162(3):459-465. doi:10.1176/appi.ajp.162.3.459.  
27  
28  
29  
30  
31 19. Spencer KM, Salisbury DF, Shenton ME, McCarley RW.  $\gamma$ -Band Auditory Steady-State  
32 Responses Are Impaired in First Episode Psychosis. *Biol Psychiatry.* 2008;64(5):369-375.  
33  
34 doi:10.1016/j.biopsych.2008.02.021.  
35  
36  
37  
38  
39 20. Hong LE, Summerfelt A, McMahon R, et al. Evoked gamma band synchronization and the  
40 liability for schizophrenia. *Schizophr Res.* 2004;70(2):293-302.  
41  
42 doi:10.1016/j.schres.2003.12.011.  
43  
44  
45  
46  
47 21. Rass O, Forsyth JK, Krishnan GP, et al. Auditory steady state response in the schizophrenia,  
48 first-degree relatives, and schizotypal personality disorder. *Schizophr Res.* 2012;136(1):143-  
49 149. doi:10.1016/j.schres.2012.01.003.  
50  
51  
52  
53  
54 22. Tada M, Nagai T, Kirihara K, et al. Differential Alterations of Auditory Gamma Oscillatory  
55 Responses Between Pre-onset High-risk Individuals and First-episode Schizophrenia. *Cereb*  
56  
57  
58  
59  
60

- 1  
2  
3  
4 *Cortex*. 2014;26(3):1027-1035. doi:10.1093/cercor/bhu278.  
5  
6  
7  
8 23. Hamm J, Gilmore C, Picchetti N. Abnormalities of neuronal oscillations and temporal  
9 integration to low-and high-frequency auditory stimulation in schizophrenia. *Biol Psychiatry*.  
10 2011;69(10):989-996.  
11  
12  
13  
14 24. Lewis DA, Hashimoto T, Volk DW. Cortical inhibitory neurons and schizophrenia. *Nat Rev*  
15 *Neurosci*. 2005;6(4):312-324. doi:10.1038/nrn1648.  
16  
17  
18  
19 25. Spencer KM, Nestor PG, Niznikiewicz MA, Salisbury DF, Shenton ME, McCarley RW.  
20 Abnormal Neural Synchrony in Schizophrenia. *J Neurosci*. 2003;23(19):7407-7411.  
21  
22  
23  
24 26. Uhlhaas P, Singer W. Oscillations and neuronal dynamics in schizophrenia: the search for  
25 basic symptoms and translational opportunities. *Biol Psychiatry*. 2015;77(12):1001–1009.  
26  
27  
28  
29 27. Traub RD, Cunningham MO, Gloveli T, et al. GABA-enhanced collective behavior in neuronal  
30 axons underlies persistent gamma-frequency oscillations. *Proc Natl Acad Sci U S A*.  
31 2003;100(19):11047-11052. doi:10.1073/pnas.1934854100.  
32  
33  
34  
35 28. Bartos M, Vida I, Jonas P. Synaptic mechanisms of synchronized gamma oscillations in  
36 inhibitory interneuron networks. *Nat Rev Neurosci*. 2007;8(1):45-56. doi:10.1038/nrn2044.  
37  
38  
39  
40 29. Sohal VS, Zhang F, Yizhar O, Deisseroth K. Parvalbumin neurons and gamma rhythms  
41 enhance cortical circuit performance. *Nature*. 2009;459(7247):698-702.  
42  
43  
44  
45  
46  
47  
48  
49  
50  
51  
52  
53 30. Gonzalez-Burgos G, Fish KN, Lewis DA, Gonzalez-Burgos G, Fish KN, Lewis DA. GABA neuron  
54 alterations, cortical circuit dysfunction and cognitive deficits in schizophrenia. *Neural Plast*.  
55  
56  
57  
58  
59  
60

- 1  
2  
3  
4 2011;2011:723184. doi:10.1155/2011/723184.  
5  
6  
7  
8 31. Woo T-UW, Spencer K, McCarley RW. Gamma oscillation deficits and the onset and early  
9 progression of schizophrenia. *Harv Rev Psychiatry*. 2010;18(3):173-189.  
10 doi:10.3109/10673221003747609.  
11  
12  
13  
14  
15 32. Yoon JH, Maddock RJ, Rokem A, et al. GABA concentration is reduced in visual cortex in  
16 schizophrenia and correlates with orientation-specific surround suppression. *J Neurosci*.  
17 2010;30(10):3777-3781. doi:10.1523/JNEUROSCI.6158-09.2010.  
18  
19  
20  
21  
22 33. Marsman A, Mandl RCW, Klomp DWJ, et al. GABA and glutamate in schizophrenia: a 7 T H-  
23 MRS study. *NeuroImage Clin*. 2014;6:398-407. doi:10.1016/j.nicl.2014.10.005.  
24  
25  
26  
27  
28 34. Mori T, Mori K, Fujii E, et al. Neuroradiological and Neurofunctional Examinations for  
29 Patients with 22q11.2 Deletion. *Neuropediatrics*. 2011;42(6):215-221. doi:10.1055/s-0031-  
30 1295479.  
31  
32  
33  
34  
35  
36 35. Sullivan EM, Timi P, Hong LE, O'Donnell P. Effects of NMDA and GABA-A Receptor  
37 Antagonism on Auditory Steady-State Synchronization in Awake Behaving Rats. *Int J*  
38 *Neuropsychopharmacol*. 2015;18(7):pyu118. doi:10.1093/ijnp/pyu118.  
39  
40  
41  
42  
43 36. Zhang J, Ma L, Li W, Yang P, Qin L. Cholinergic modulation of auditory steady-state response  
44 in the auditory cortex of the freely moving rat. *Neuroscience*. 2016;324:29-39.  
45  
46  
47  
48  
49  
50  
51  
52 37. Sivarao D V. The 40-Hz auditory steady-state response a selective biomarker for cortical  
53 NMDA function. *Ann N Y Acad Sci*. 2015;1344:27-36. doi:10.1111/nyas.12739.  
54  
55  
56  
57  
58  
59  
60



- 1  
2  
3  
4 38. Sivarao D V, Chen P, Senapati A, et al. 40 Hz Auditory Steady-State Response Is a  
5  
6 Pharmacodynamic Biomarker for Cortical NMDA Receptors. *Neuropsychopharmacology*.  
7  
8 2016;41(9):2232-2240. doi:10.1038/npp.2016.17.  
9  
10  
11  
12 39. Nakao K, Nakazawa K. Brain state-dependent abnormal LFP activity in the auditory cortex of  
13  
14 a schizophrenia mouse model. *Front Neurosci*. 2014;8:168. doi:10.3389/fnins.2014.00168.  
15  
16  
17 40. Carlén M, Meletis K, Siegle JH, et al. A critical role for NMDA receptors in parvalbumin  
18  
19 interneurons for gamma rhythm induction and behavior. *Mol Psychiatry*. 2012;17(5):537-  
20  
21 548. doi:10.1038/mp.2011.31.  
22  
23  
24  
25 41. Vierling-Claassen D, Siekmeier P, Stufflebeam S, Kopell N. Modeling GABA alterations in  
26  
27 schizophrenia: a link between impaired inhibition and altered gamma and beta range  
28  
29 auditory entrainment. *J Neurophysiol*. 2008;99(5):2656-2671. doi:10.1152/jn.00870.2007.  
30  
31  
32  
33 42. Chun S, Westmoreland JJ, Bayazitov IT, et al. Specific disruption of thalamic inputs to the  
34  
35 auditory cortex in schizophrenia models. *Science*. 2014;344(6188):1178-1182.  
36  
37  
38 doi:10.1126/science.1253895.  
39  
40  
41 43. Didriksen M, Fejgin K, Nilsson SRO, et al. Persistent gating deficit and increased sensitivity to  
42  
43 NMDA receptor antagonism after puberty in a new mouse model of the human 22q11.2  
44  
45 microdeletion syndrome: a study in male mice. *J Psychiatry Neurosci*. 2016;41(5):150381.  
46  
47  
48  
49 44. Rihs T a, Tomescu MI, Britz J, et al. Altered auditory processing in frontal and left temporal  
50  
51 cortex in 22q11.2 deletion syndrome: a group at high genetic risk for schizophrenia.  
52  
53 *Psychiatry Res*. 2013;212(2):141-149. doi:10.1016/j.psychresns.2012.09.002.  
54  
55  
56  
57 45. McGlashan TH, Miller TJ, Woods SW, Rosen JL, Hoffmann RE, Davidson L. *Structured*  
58  
59  
60

- 1  
2  
3  
4 *Interview for Prodromal Syndromes (SIPS). Norsk Version 5.0.* Stavanger  
5  
6 Universitetssjukehus, Norge; 2012.  
7  
8  
9  
10 46. Miller TJ, McGlashan TH, Rosen JL, et al. Prodromal assessment with the structured  
11  
12 interview for prodromal syndromes and the scale of prodromal symptoms: predictive  
13  
14 validity, interrater reliability, and training to reliability. *Schizophr Bull.* 2003;29(4):703-715.  
15  
16  
17 47. Schmock H, Vangkilde A, Larsen KM, et al. The Danish 22q11 research initiative. *BMC*  
18  
19 *Psychiatry.* 2015;15(1):220. doi:10.1186/s12888-015-0594-7.  
20  
21  
22  
23 48. Oostenveld R, Fries P, Maris E, et al. FieldTrip: Open source software for advanced analysis  
24  
25 of MEG, EEG, and invasive electrophysiological data. *Comput Intell Neurosci.*  
26  
27 2011;2011:156869. doi:10.1155/2011/156869.  
28  
29  
30  
31 49. Başar E. A review of gamma oscillations in healthy subjects and in cognitive impairment. *Int*  
32  
33 *J Psychophysiol.* 2013;90(2):99-117. doi:10.1016/j.ijpsycho.2013.07.005.  
34  
35  
36 50. Buzsáki G, Wang X-J. Mechanisms of gamma oscillations. *Annu Rev Neurosci.* 2012;35:203-  
37  
38 225. doi:10.1146/annurev-neuro-062111-150444.  
39  
40  
41  
42 51. Jadi MP, Behrens MM, Sejnowski TJ. Abnormal Gamma Oscillations in N-Methyl-D-Aspartate  
43  
44 Receptor Hypofunction Models of Schizophrenia. *Biol Psychiatry.* 2016;79(9):716-726.  
45  
46 doi:10.1016/j.biopsych.2015.07.005.  
47  
48  
49  
50 52. Cardin JA. Dissecting local circuits in vivo: Integrated optogenetic and electrophysiology  
51  
52 approaches for exploring inhibitory regulation of cortical activity. *J Physiol.*  
53  
54 2012;106(3):104-111. doi:10.1016/j.jphysparis.2011.09.005.  
55  
56  
57  
58  
59  
60

- 1  
2  
3  
4 53. Sohal VS. Insights into Cortical Oscillations Arising from Optogenetic Studies. *Biol Psychiatry*.  
5  
6 2012;71(12):1039-1045. doi:10.1016/j.biopsych.2012.01.024.  
7  
8  
9  
10 54. Lisman JE, Coyle JT, Green RW, et al. Circuit-based framework for understanding  
11 neurotransmitter and risk gene interactions in schizophrenia. *Trends Neurosci*.  
12 2008;31(5):234-242. doi:10.1016/j.tins.2008.02.005.  
13  
14  
15  
16  
17 55. Hamm JP, Gilmore CS, Clementz BA. Augmented gamma band auditory steady-state  
18 responses: support for NMDA hypofunction in schizophrenia. *Schizophr Res*. 2012;138(1):1-  
19 7. doi:10.1016/j.schres.2012.04.003.  
20  
21  
22  
23  
24  
25 56. Poulsen C, Picton TW, Paus T. Age-related changes in transient and oscillatory brain  
26 responses to auditory stimulation during early adolescence. *Dev Sci*. 2009;12(2):220-235.  
27 doi:10.1111/j.1467-7687.2008.00760.x.  
28  
29  
30  
31  
32  
33 57. Rojas DC, Maharajh K, Teale PD, et al. Development of the 40Hz steady state auditory  
34 evoked magnetic field from ages 5 to 52. *Clin Neurophysiol*. 2006;117(1):110-117.  
35 doi:10.1016/j.clinph.2005.08.032.  
36  
37  
38  
39  
40  
41 58. Uhlhaas PJ, Roux F, Rodriguez E, Rotarska-Jagiela A, Singer W. Neural synchrony and the  
42 development of cortical networks. *Trends Cogn Sci*. 2010;14(2):72-80.  
43 doi:10.1016/j.tics.2009.12.002.  
44  
45  
46  
47  
48  
49 59. Hashimoto T, Nguyen QL, Rotaru D, et al. Protracted Developmental Trajectories of GABAA  
50 Receptor  $\alpha 1$  and  $\alpha 2$  Subunit Expression in Primate Prefrontal Cortex. *Biol Psychiatry*.  
51 2009;65(12):1015-1023. doi:10.1016/j.biopsych.2009.01.004.  
52  
53  
54  
55  
56  
57 60. Jonas RK, Montojo CA, Bearden CE. The 22q11.2 deletion syndrome as a window into  
58  
59  
60

1  
2  
3  
4 complex neuropsychiatric disorders over the lifespan. *Biol Psychiatry*. 2014;75(5):351-360.  
5  
6 doi:10.1016/j.biopsych.2013.07.019.  
7  
8

- 9  
10 61. Squarcione C, Torti MC, Di Fabio F, Biondi M. 22q11 deletion syndrome: a review of the  
11 neuropsychiatric features and their neurobiological basis. *Neuropsychiatr Dis Treat*.  
12 2013;9:1873-1884. doi:10.2147/NDT.S52188.  
13  
14  
15  
16  
17 62. Larsen TK, Melle I, Auestad B, et al. Early detection of psychosis: positive effects on 5-year  
18 outcome. *Psychol Med*. 2010;41(7):1461-1469. doi:10.1017/S0033291710002023.  
19  
20  
21  
22  
23 63. Hegelstad W ten V, Larsen TK, Auestad B, et al. Long-Term Follow-Up of the TIPS Early  
24 Detection in Psychosis Study: Effects on 10-Year Outcome. *Am J Psychiatry*.  
25 2012;169(4):374-380. doi:10.1176/appi.ajp.2011.11030459.  
26  
27  
28  
29  
30  
31  
32  
33  
34  
35  
36  
37  
38  
39  
40  
41  
42  
43  
44  
45  
46  
47  
48  
49  
50  
51  
52  
53  
54  
55  
56  
57  
58  
59  
60

**Figure 1**

Temporal structure of the auditory stimulation paradigm to evoke 40 Hz auditory steady-state responses. Regular (run 1) and irregular (run 2) 40 Hz click trains were given in separate experimental blocks. Each click train had duration of 1 s, followed by a pause of 2 s. Clicks were applied every 25 ms at a constant frequency of 40 Hz in the regular condition and randomly jittered from 11 to 37 ms in the irregular condition. An epoch covered the period of 40 Hz stimulation and a peristimulus window of -1000 to 2000 ms.

**Figure 2**

Group time frequency plots of the ASSR within the 10-60 Hz range from electrode Cz. (A) Group ITPC of the ASSR for the regular (top) and irregular (bottom), for both non carriers (left) and 22q11.2 carriers (right). (B) Group power of the ASSR, again shown for both conditions and groups. In both (A) and (B), the time stamp 0 indicates the onset of the click train. Duration of the click train is illustrated by the grey box. In the time-frequency response a cut-off can be seen (i.e. white area without data in the color plots) due to the length of the wavelet being longer for the lower frequencies as compared to higher frequencies. Consequently not all time point values can be estimated. (C) Topographical maps for ITPC presented for controls, 22q11.2 and both conditions as in A in the time window 300ms-700ms and frequency window 36 Hz- 44 Hz. (D) Topographical maps for power presented for controls, 22q11.2 and both conditions as in B in the time window 300ms-700ms and frequency window 36 Hz- 44 Hz.

**Figure 3**

Group data of the ASSR. Mean ITPC (A) and mean gamma power (B) of the ASSR evoked by regular or irregular 40 Hz click trains in 22q11.2 carriers (light grey) and healthy non-carriers (dark grey). Asterisks indicate significant between-group difference (\*  $p < 0.05$ , \*\*  $p < 0.01$ ). Error bars equal SEM (standard error of the mean). (C) and (D) shows ITPC and power as a function of SIPS negative sub-scale scores respectively. Since the non-parametric spearman rank correlation was used, there is no regression line.

1  
2  
3  
4  
5  
6  
7  
8  
9  
10  
11  
12  
13  
14  
15  
16  
17  
18  
19  
20  
21  
22  
23  
24  
25  
26  
27  
28  
29  
30  
31  
32  
33  
34  
35  
36  
37  
38  
39  
40  
41  
42  
43  
44  
45  
46  
47  
48  
49  
50  
51  
52  
53  
54  
55  
56  
57  
58  
59  
60

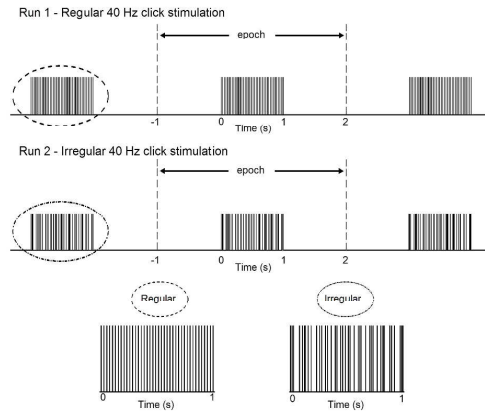

254x190mm (300 x 300 DPI)

1  
2  
3  
4  
5  
6  
7  
8  
9  
10  
11  
12  
13  
14  
15  
16  
17  
18  
19  
20  
21  
22  
23  
24  
25  
26  
27  
28  
29  
30  
31  
32  
33  
34  
35  
36  
37  
38  
39  
40  
41  
42  
43  
44  
45  
46  
47  
48  
49  
50  
51  
52  
53  
54  
55  
56  
57  
58  
59  
60

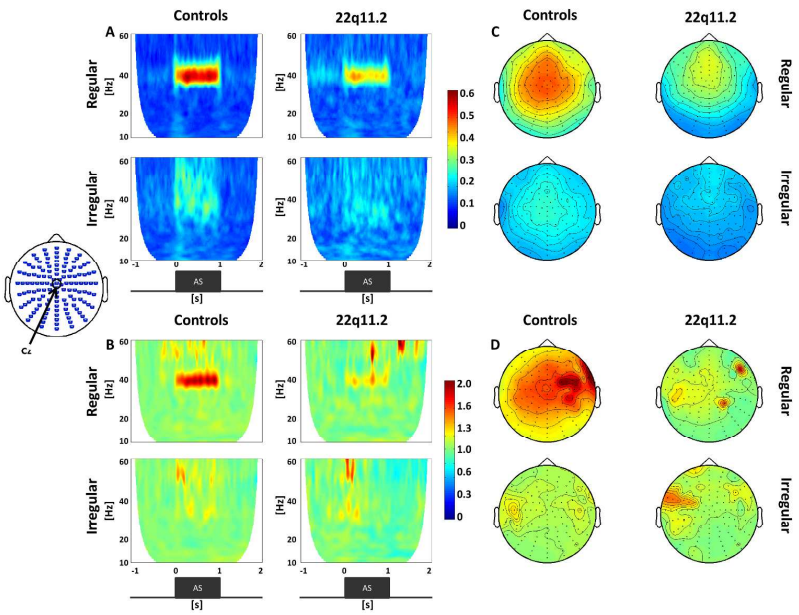

254x190mm (300 x 300 DPI)



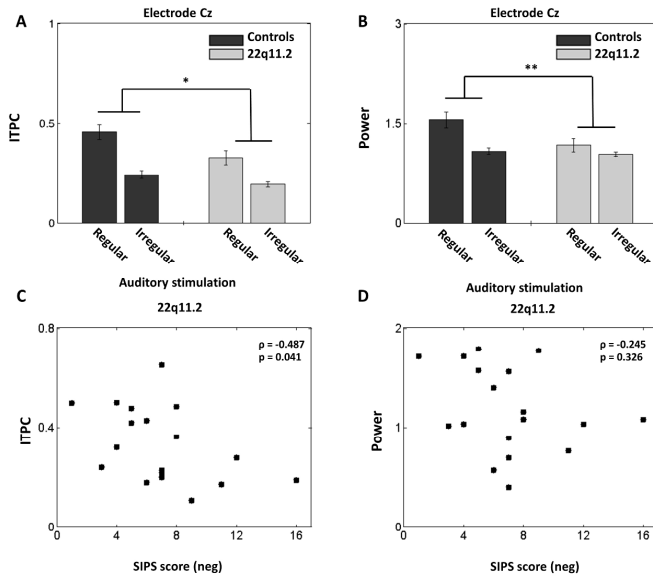

254x190mm (300 x 300 DPI)

1  
2  
3  
4  
5  
6  
7  
8  
9  
10  
11  
12  
13  
14  
15  
16  
17  
18  
19  
20  
21  
22  
23  
24  
25  
26  
27  
28  
29  
30  
31  
32  
33  
34  
35  
36  
37  
38  
39  
40  
41  
42  
43  
44  
45  
46  
47  
48  
49  
50  
51  
52  
53  
54  
55  
56  
57  
58  
59  
60

1  
2  
3  
4 Supplementary materials

5  
6 **Diagnosis**

7  
8 Diagnoses of affective disorder (F30-F33), anxiety and phobias (F4x), and disturbance of  
9 activity and attention/attention deficit disorder without hyperactivity (F90.0/98.8C) were given  
10 based on the Mini International Neuropsychiatric Interview<sup>1</sup> or the Mini International  
11 Neuropsychiatric Interview for Children and Adolescents<sup>2</sup>. IQ below 70 determined from Reynolds  
12 Intellectual Screening Test (RIST)<sup>3</sup> was used as an indication of intellectual disability and  
13 indications of autism spectrum disorders were obtained from the Social Communication  
14 Questionnaire lifetime form using the clinical cut-off of 15<sup>4,5</sup>.

15  
16  
17  
18 **Symptomatology**

19  
20 The Structured Interview for Prodromal Syndromes (SIPS)<sup>6,7</sup> was used to rate the severity of:  
21 positive, negative, disorganized, and general symptoms. SIPS ratings are given on a 0 (absence of  
22 symptoms) - 6 (extremely severe symptoms) point scale where scores of 3–5 are within the  
23 attenuated range. The total positive symptoms raw score (0-30) covers; delusional ideas,  
24 persecutory ideas, grandiosity, hallucinations, and disorganized communication. The total negative  
25 symptoms raw score (0-36) is a composite measure of anhedonia or withdrawal, avolition,  
26 decreased expression of emotions, decreased experience of emotion or self, impoverished  
27 thinking, and deterioration of role functioning. The disorganized composite raw score (0-24)  
28 includes: odd behavior and appearance, bizarre thinking, trouble with focus and attention, and  
29 personal hygiene. The total score of generalized symptoms (0-25) include: sleep disturbance,  
30 dysphoric mood, motor disturbances, and impaired tolerance to normal stress. The SIPS interviews  
31 were conducted by two experienced and SIPS certified clinicians who demonstrated good inter-  
32 rater-reliability.  
33  
34  
35  
36  
37  
38  
39  
40  
41

42  
43 **20 dB-random test**

44 In the 20 dB- random test (Oscilla USB-310 Tablet screening audiometer, Aarhus, Denmark),  
45 subjects were asked to detect tones presented at 20 dB via headphones to the right or left ear at  
46 different frequencies (125, 250, 500, 750, 1000, 1500, 2000, 3000, 4000, 6000, 8000, 125, 250,  
47 500, 750, 1000, 1500, 2000, 3000, 4000, 6000 and 8000 Hz). The sound pressure was increased in  
48 5 dB steps if subjects did not respond.  
49

50  
51 **Artifact removal**

52 On average the percentage of trials rejected was less than 6% and did not differ significantly  
53 between groups and stimulation conditions (Control group – regular stimulation : 2.5%, Control  
54 group – irregular stimulation: 2.5%, 22q11.2 group – regular stimulation: 5.2%, 22q11.2 group –  
55 irregular stimulation: 6.0%;  $p > 0.05$  consistently using a two-sample t-test.).  
56  
57  
58  
59  
60

### Time-frequency analysis

The inter-trial phase coherence (ITPC) for each channel, frequency- and time bin were extracted from the wavelet coefficients  $X(ch, f, t, n)$  by  $ITPC(ch, f, t) = \frac{1}{N} \sum_n \frac{X(ch, f, t, n)}{|X(ch, f, t, n)|}$  where n refers to a single epoch. The amplitude of the ITPC reflects the phase consistency across trials for a given channel, time and frequency point and can take values between 0 (no phase consistency) and 1 (perfect phase consistency). Thus, the higher the ITPC, the more consistent and the more stable were the gamma steady-state responses to 40 Hz click stimulation. The gamma power was extracted taking the wavelet coefficients, multiplying with the conjugated and normalizing relative to baseline separately for each epoch.

### Post-hoc tests

Within the 22q11.2DS group we did two post-hoc 2-way rm-ANCOVA (power of ASSR and ITPC of ASSR) testing for effect of present psychiatric diagnosis on the ASSR, with factors group (diagnosis and non-diagnosis) and condition (regular irregular). Similarly we divided the 22q11.2 deletion carriers in half according to IQ (low IQ vs. high IQ) and post-hoc tested the effect on ASSR. The rm-ANOVA testing for the effect of present psychiatric diagnosis as well as IQ on ASSR within the 22q11.2DS group revealed no group effect (diagnosis vs no-diagnosis and low IQ vs. high IQ) and no interaction (group and condition).

### Demographical, clinical and EEG data summarized

Table 1. Summary of group data for demographical, clinical and EEG data

Measures	Control group	22q11.2 group	Group statistics
Age	Mean 15.96 SD = 2.71	Mean 15.39 SD = 2.45	$t_{43} = 0.72, p = 0.47$
Sex	18 males / 9 females	13 males / 5 females	$\chi^2 = 0.54, p = 0.46$
IQ	Median = 108.0 90 <sup>th</sup> percentile = 127 10 <sup>th</sup> percentile = 95.2	Median = 82.0 90 <sup>th</sup> percentile = 94.8 10 <sup>th</sup> percentile = 63.6	$t_{43} = -7.05, p < 0.001$
<b>SIPS - subscales</b>			
Negative	Mean 0.59 SD = 1.04 Range 0-4	Mean 7.00 SD = 3.50 Range 1-16	$W = 477, p = <0.001$
Positive	Mean 0.81 SD = 1.49 Range 0-6	Mean 2.70 SD = 3.10 Range 1-12	$W = 305.5, p = 0.008$
Disorganized	Mean 0.11 SD = 0.42 Range 0-2	Mean 1.80 SD = 1.80 Range 0-6	$W = 404, p < 0.001$
Generalized	Mean 0.15 SD = 0.46 Range 0-2	Mean 1.00 SD = 1.90 Range 0-7	$W = 312.5, p = 0.027$
<b>EEG - readouts</b>			
ITPC regular	Mean 0.46 SD = 0.19	Mean 0.33 SD = 0.15	
ITPC irregular	Mean 0.24 SD = 0.11	Mean 0.19 SD = 0.05	
Power regular	Mean 1.56 SD = 0.59	Mean 1.18 SD = 0.44	
Power irregular	Mean 1.09 SD = 0.25	Mean 1.05 SD = 0.12	

1. Sheehan D V., Lecrubier Y, Sheehan KH, et al. The Mini-International Neuropsychiatric Interview (M.I.N.I.): The development and validation of a structured diagnostic psychiatric interview for DSM-IV and ICD-10. In: *Journal of Clinical Psychiatry*. Vol 59. ; 1998:22-33-57.
2. Sheehan D, Shytle, K. Milo JJY. *M.I.N.I. International Neuropsychiatric Interview For Children and Adolescents (M.I.N.I-Kid)*. Dansk Version 6.0 2013; 2013.
3. Reynolds CR&, Kamphaus RW. *Reynolds Intellectual Assessment Scales (RIAS), Reynolds Intellectual Screening Test (RIST)*. Dansk Version - Vejledning. Hogrefe Psykologisk Forlag. København, Danmark; 2011.
4. Rutter M, Bailey A, Lord C. *The Social Communication Questionnaire (SCQ). Manual. (Form: Lifetime)*. Western Psychological Services. Los Angeles, CA; 2003.
5. Rutter M, Bailey A, Berument SK, Lord C, Pickles A. *The Social Communication Questionnaire (SCQ)*.

1  
2  
3  
4 Dansk Version - *Vurdering Livsforløb*. Hogrefe Psykologisk Forlag. København, Danmark; 2005.  
5

- 6 6. McGlashan TH, Miller TJ, Woods SW, Rosen JL, Hoffmann RE, Davidson L. *Structured Interview for*  
7 *Prodromal Syndromes (SIPS)*. Norsk Version 5.0. Stavanger Universitetssjukehus, Norge; 2012.  
8  
9 7. Miller TJ, McGlashan TH, Rosen JL, et al. Prodromal assessment with the structured interview for  
10 prodromal syndromes and the scale of prodromal symptoms: predictive validity, interrater  
11 reliability, and training to reliability. *Schizophr Bull.* 2003;29(4):703-715.  
12 <http://www.ncbi.nlm.nih.gov/pubmed/14989408>. Accessed July 4, 2016.  
13  
14  
15  
16  
17  
18  
19  
20  
21  
22  
23  
24  
25  
26  
27  
28  
29  
30  
31  
32  
33  
34  
35  
36  
37  
38  
39  
40  
41  
42  
43  
44  
45  
46  
47  
48  
49  
50  
51  
52  
53  
54  
55  
56  
57  
58  
59  
60

# Bibliography

---

*Adams Rick A, Stephan Klaas Enno, Brown Harriet R, Frith Christopher D, Friston Karl J.* The computational anatomy of psychosis. // *Frontiers in psychiatry.* jan 2013. 4. 47.

*Andreasen Nancy C., Arndt Stephan, Alliger Randall, Miller Del, Flaum Michael, NC Andreasen, Al. et.* Symptoms of Schizophrenia // *Archives of General Psychiatry.* may 1995. 52, 5. 341.

*Atkinson Rebekah J., Michie Patricia T., Schall Ulrich.* Duration mismatch negativity and P3a in first-episode psychosis and individuals at ultra-high risk of psychosis // *Biological Psychiatry.* 2012. 71, 2. 98–104.

*Azzena Gian Battista, Conti Guido, Santarelli Rosamaria, Ottaviani Fabrizio, Paludetti Gaetano, Maurizi Maurizio.* Generation of human auditory steady-state responses (SSRs). I: Stimulus rate effects // *ELSEVIER Hearing Research.* 1995. 83. 1–8.

*Baker Kate, Baldeweg Torsten, Sivagnanasundaram Sinthuja, Scambler Peter, Skuse David.* COMT Val108/158Met modifies mismatch negativity and cognitive function in 22q11 deletion syndrome // *Biological Psychiatry.* jul 2005. 58, 1. 23–31.

*Baldeweg Torsten, Klugman Anthony, Gruzelier John, Hirsch Steven R.* Mismatch negativity potentials and cognitive impairment in schizophrenia // *Schizophrenia Research.* 2004. 69, 2-3. 203–217.

*Baldeweg Torsten, Klugman Anthony, Gruzelier John H, Hirsch Steven R.* Impairment in frontal but not temporal components of mismatch negativity in

- schizophrenia. // International journal of psychophysiology : official journal of the International Organization of Psychophysiology. feb 2002. 43, 2. 111–22.
- Bartos Marlene, Vida Imre, Jonas Peter.* Synaptic mechanisms of synchronized gamma oscillations in inhibitory interneuron networks. // Nature reviews. Neuroscience. jan 2007. 8, 1. 45–56.
- Bassett Anne S, Marshall Christian R, Lionel Anath C, Chow Eva W C, Scherer Stephen W.* Copy number variations and risk for schizophrenia in 22q11.2 deletion syndrome. // Human molecular genetics. dec 2008. 17, 24. 4045–53.
- Bodatsch Mitja, Ruhrmann Stephan, Wagner Michael, Mller Ralf, Schultze-Lutter Frauke, Frommann Ingo, Brinkmeyer Jrgen, Gaebel Wolfgang, Maier Wolfgang, Klosterktter Joachim, Brockhaus-Dumke Anke.* Prediction of psychosis by mismatch negativity // Biological Psychiatry. 2011. 69, 10. 959–966.
- Brenner Colleen A, Sporns Olaf, Lysaker Paul H, O'Donnell Brian F.* EEG synchronization to modulated auditory tones in schizophrenia, schizoaffective disorder, and schizotypal personality disorder. // The American journal of psychiatry. dec 2003. 160, 12. 2238–40.
- Buzsáki G, Chrobak J J.* Temporal structure in spatially organized neuronal ensembles: a role for interneuronal networks. // Current opinion in neurobiology. aug 1995. 5, 4. 504–10.
- Buzsáki György, Wang Xiao-Jing.* Mechanisms of gamma oscillations. // Annual review of neuroscience. jan 2012. 35. 203–25.
- Carlén M, Meletis K, Siegle J H, Cardin J A, Futai K, Vierling-Claassen D, Rühlmann C, Jones S R, Deisseroth K, Sheng M, Moore C I, Tsai L-H.* A critical role for NMDA receptors in parvalbumin interneurons for gamma rhythm induction and behavior // Molecular Psychiatry. may 2012. 17, 5. 537–548.
- Catts S V, Shelley A M, Ward P B, Liebert B, McConaghy N, Andrews S, Michie P T.* Brain potential evidence for an auditory sensory memory deficit in schizophrenia. // The American journal of psychiatry. feb 1995. 152, 2. 213–9.
- Chen Chi-Ming A, Stanford Arielle D, Mao Xiangling, Abi-Dargham Anissa, Shungu Dikoma C, Lisanby Sarah H, Schroeder Charles E, Kegeles Lawrence S.* GABA level, gamma oscillation, and working memory performance in schizophrenia. // NeuroImage. Clinical. 2014. 4. 531–9.
- Cheour M, Haapanen M L, Hukki J, Ceponiene R, Kurjenluoma S, Alho K, Tervaniemi M, Ranta R, Näätänen R.* The first neurophysiological evidence for cognitive brain dysfunctions in children with CATCH. // Neuroreport. may 1997. 8, 7. 1785–7.

- Cohen Mike X.* Analyzing Neural Time Series Data. 2014.
- Cowan Ronald L., Wilson Charles J., Emson Piers C., Heizmann Claus W.* Parvalbumin-containing gabaergic interneurons in the rat neostriatum // *The Journal of Comparative Neurology.* dec 1990. 302, 2. 197–205.
- David Olivier, Harrison Lee, Friston Karl J.* Modelling event-related responses in the brain // *NeuroImage.* 2005. 25, 3. 756–770.
- David Olivier, Kiebel Stefan J., Harrison Lee M., Mattout Jérémie, Kilner James M., Friston Karl J.* Dynamic causal modeling of evoked responses in EEG and MEG // *NeuroImage.* 2006. 30, 4. 1255–1272.
- Delorme Arnaud, Makeig Scott.* EEGLAB: an open source toolbox for analysis of single-trial EEG dynamics including independent component analysis. // *Journal of neuroscience methods.* mar 2004. 134, 1. 9–21.
- Dima D., Frangou S., Burge L., Braeutigam S., James A.C.* Abnormal intrinsic and extrinsic connectivity within the magnetic mismatch negativity brain network in schizophrenia: A preliminary study // *Schizophrenia Research.* mar 2012. 135, 1-3. 23–27.
- Dima Danai, Dietrich Detlef E., Dillo Wolfgang, Emrich Hinderk M.* Impaired top-down processes in schizophrenia: A DCM study of ERPs // *NeuroImage.* 2010. 52, 3. 824–832.
- Doeller Christian F. CF, Opitz Bertram, Mecklinger Axel, Krick Christoph, Reith Wolfgang, Schröger Erich.* Prefrontal cortex involvement in preattentive auditory deviance detection: Neuroimaging and electrophysiological evidence // *NeuroImage.* 2003. 20, 2. 1270–1282.
- Felleman D J, Van Essen D C.* Distributed hierarchical processing in the primate cerebral cortex. // *Cerebral cortex (New York, N.Y. : 1991).* 1991. 1, 1. 1–47.
- Fogelson Noa, Litvak Vladimir, Peled Avi, Olmo Miguel Fernandez-del, Friston Karl.* The functional anatomy of schizophrenia: A dynamic causal modeling study of predictive coding // *Schizophrenia Research.* 2014. 158, 1-3. 204–212.
- Foxe John J, Yeap Sherlyn, Snyder Adam C, Kelly Simon P, Thakore Jogin H, Molholm Sophie.* The N1 auditory evoked potential component as an endophenotype for schizophrenia: high-density electrical mapping in clinically unaffected first-degree relatives, first-episode, and chronic schizophrenia patients. // *European archives of psychiatry and clinical neuroscience.* aug 2011. 261, 5. 331–9.



- Friston K.* Learning and inference in the brain // *Neural Networks*. 2003. 16. 1325–1352.
- Friston K, Mattout J, Trujillo-Barreto N.* Variational free energy and the Laplace approximation // *Neuroimage*. 2007. 34, 1. 220–234.
- Dynamic causal modelling of evoked brain responses. // . 2005. 1–164.
- Friston K J.* Bayesian Estimation of Dynamical Systems: An Application to fMRI // *Neuroimage*. 2002a. 16. 513–530.
- Friston K.J., Harrison L., Penny W.* Dynamic causal modelling // *NeuroImage*. aug 2003. 19, 4. 1273–1302.
- Friston Karl.* Functional integration and inference in the brain // *Progress in Neurobiology*. 2002b. 68, 2. 113–143.
- Friston Karl.* A theory of cortical responses. // *Philosophical transactions of the Royal Society of London. Series B, Biological sciences*. apr 2005. 360, 1456. 815–36.
- Friston Karl J.* The disconnection hypothesis // *Schizophrenia Research*. mar 1998. 30, 2. 115–125.
- Friston Karl J.* Functional and Effective Connectivity: A Review // *Brain Connectivity*. jan 2011. 1, 1. 13–36.
- Gabor D.* Theory of communication. Part 1: The analysis of information // *Journal of the Institution of Electrical Engineers - Part III: Radio and Communication Engineering*. nov 1946. 93, 26. 429–441.
- Galambos R, Makeig S, Talmachoff P J.* A 40-Hz auditory potential recorded from the human scalp. // *Proceedings of the National Academy of Sciences of the United States of America*. apr 1981. 78, 4. 2643–7.
- Garrido Marta I., Friston Karl J., Kiebel Stefan J., Stephan Klaas E., Baldeweg Torsten, Kilner James M.* The functional anatomy of the MMN: A DCM study of the roving paradigm // *NeuroImage*. 2008. 42, 2. 936–944.
- Garrido Marta I., Kilner James M, Kiebel Stefan J, Stephan Klaas E, Friston Karl J.* Dynamic causal modelling of evoked potentials: A reproducibility study // *NeuroImage*. 2007. 36. 571–580.
- Garrido Marta I., Kilner James M, Stephan Klaas E, Friston Karl J.* The mismatch negativity: A review of underlying mechanisms // *Clinical Neurophysiology*. mar 2009. 120, 3. 453–463.

- Gonzalez-Burgos Guillermo, Fish Kenneth N, Lewis David A, Gonzalez-Burgos Guillermo, Fish Kenneth N, Lewis David A.* GABA neuron alterations, cortical circuit dysfunction and cognitive deficits in schizophrenia. // *Neural plasticity*. 2011. 2011. 723184.
- Goodship J, Cross I, LiLing J, Wren C.* A population study of chromosome 22q11 deletions in infancy. // *Archives of disease in childhood*. oct 1998. 79, 4. 348–51.
- Goswami Jaideva C., Chan Andrew K.* Time-Frequency Analysis // *Fundamentals of Wavelets*. Hoboken, NJ, USA: John Wiley & Sons, Inc., nov 2010. 61–93.
- Grau C, Fuentemilla L, Marco-Pallares J.* Functional neural dynamics underlying auditory event-related N1 and N1 suppression response // *Neuroimage*. 2007. 36, 3. 522–531.
- Haigh Sarah M, Coffman Brian A, Salisbury Dean F.* Mismatch Negativity in First-Episode Schizophrenia: A Meta-Analysis. // *Clinical EEG and neuroscience*. may 2016.
- Hegelstad Wenche ten Velden, Larsen Tor K., Auestad Bjørn, Evensen Julie, Haahr Ulrik, Joa Inge, Johannesen Jan O., Langeveld Johannes, Melle Ingrid, Opjordsmoen Stein, Rossberg Jan Ivar, Rund Bjørn Rishovd, Simonsen Erik, Sundet Kjetil, Vaglum Per, Friis Svein, McGlashan Thomas.* Long-Term Follow-Up of the TIPS Early Detection in Psychosis Study: Effects on 10-Year Outcome // *American Journal of Psychiatry*. apr 2012. 169, 4. 374–380.
- Herrmann CS, Grigutsch M.* EEG Oscillations and Wavelet Analysis // *Event-related Potentials: A Methods Handbook*. 2005.
- Hong L.Elliott, Summerfelt Ann, McMahon Robert, Adami Helene, Francis Grace, Elliott Amie, Buchanan Robert W., Thaker Gunvant K.* Evoked gamma band synchronization and the liability for schizophrenia // *Schizophrenia Research*. 2004. 70, 2. 293–302.
- Hsieh Ming H, Shan Jia-Chi, Huang Wei-Lieh, Cheng Wan-Chen, Chiu Ming-Jang, Jaw Fu-Shan, Hwu Hai-Gwo, Liu Chen-Chung.* Auditory event-related potential of subjects with suspected pre-psychotic state and first-episode psychosis. // *Schizophrenia research*. sep 2012. 140, 1-3. 243–9.
- Jääskeläinen Iiro P, Ahveninen Jyrki, Bonmassar Giorgio, Dale Anders M, Ilmoniemi Risto J, Levänen Sari, Lin Fa-Hsuan, May Patrick, Melcher Jennifer, Stufflebeam Steven, Tiihinen Hannu, Belliveau John W.* Human posterior auditory cortex gates novel sounds to consciousness. // *Proceedings of the National*

- Academy of Sciences of the United States of America. apr 2004. 101, 17. 6809–14.
- Jansen Ben H., Rit Vincent G.* Electroencephalogram and visual evoked potential generation in a mathematical model of coupled cortical columns // *Biological Cybernetics*. sep 1995. 73, 4. 357–366.
- Jessen Frank, Fries Thomas, Kucharski Claudia, Nishimura Tsuneko, Hoenig Klaus, Maier Wolfgang, Falkai Peter, Heun Reinhard.* Amplitude reduction of the mismatch negativity in first-degree relatives of patients with schizophrenia. 2001.
- Kiebel Stefan J., David Olivier, Friston Karl J.* Dynamic causal modelling of evoked responses in EEG/MEG with lead field parameterization // *NeuroImage*. 2006. 30, 4. 1273–1284.
- Kiebel Stefan J, Garrido Marta I., Moran Rosalyn J, Friston Karl J.* Dynamic causal modelling for EEG and MEG. // *Cognitive neurodynamics*. jun 2008. 2, 2. 121–36.
- Knill David C., Pouget Alexandre.* The Bayesian brain: the role of uncertainty in neural coding and computation // *Trends in Neurosciences*. 2004. 27, 12. 712–719.
- Krishnan G P, Hetrick W P, Brenner C A, Shekhar A, Steffen A N, O'Donnell B F.* Steady state and induced auditory gamma deficits in schizophrenia. // *NeuroImage*. oct 2009. 47, 4. 1711–9.
- Kwon J S, O'Donnell B F, Wallenstein G V, Greene R W, Hirayasu Y, Nestor P G, Hasselmo M E, Potts G F, Shenton M E, McCarley R W.* Gamma frequency-range abnormalities to auditory stimulation in schizophrenia. // *Archives of general psychiatry*. nov 1999. 56, 11. 1001–5.
- Larsen T. K., Melle I., Auestad B., Haahr U., Joa I., Johannessen J. O., Opjordsmoen S., Rund B. R., Rossberg J. I., Simonsen E., Vaglum P., Friis S., McGlashan T.* Early detection of psychosis: positive effects on 5-year outcome // *Psychological Medicine*. oct 2010. 41, 07. 1461–1469.
- Lewis D A, Pierri J N, Volk D W, Melchitzky D S, Woo T U.* Altered GABA neurotransmission and prefrontal cortical dysfunction in schizophrenia. // *Biological psychiatry*. sep 1999. 46, 5. 616–26.
- Lewis David A, Hashimoto Takanori, Volk David W.* Cortical inhibitory neurons and schizophrenia. // *Nature reviews. Neuroscience*. apr 2005. 6, 4. 312–24.

- Light Gregory a., Hsu Jung Lung, Hsieh Ming H., Meyer-Gomes Katrin, Sprock Joyce, Swerdlow Neal R., Braff David L.* Gamma band oscillations reveal neural network cortical coherence dysfunction in schizophrenia patients // *Biological Psychiatry*. 2006. 60, 11. 1231–1240.
- Luck Steven J.* An Introduction to the Event-Related Potential Technique. 2014.
- Luck Steven J, Mathalon Daniel H, O'Donnell Brian F, Hämäläinen Matti S, Spencer Kevin M, Javitt Daniel C, Uhlhaas Peter J.* A roadmap for the development and validation of event-related potential biomarkers in schizophrenia research. // *Biological psychiatry*. jul 2011. 70, 1. 28–34.
- Mallat Stephane G.* A Theory for Multiresolution Signal Decomposition: The Wavelet Representation // *IEEE TRANSACTIONS ON PATTERN ANALYSIS AND MACHINE INTELLIGENCE*. VOL. II. 1989. 11, 7.
- Marsman Anouk, Mandl René C W, Klomp Dennis W J, Bohlken Marc M, Boer Vincent O, Andreychenko Anna, Cahn Wiepke, Kahn René S, Luijten Peter R, Hulshoff Pol Hilleke E.* GABA and glutamate in schizophrenia: a 7 T H-MRS study. // *NeuroImage. Clinical*. 2014. 6. 398–407.
- Melle Ingrid, Larsen Tor K, Haahr Ulrik, Friis Svein, Johannessen Jan Olav, Opjordsmoen Stein, Simonsen Erik, Rund Bjørn Rishovd, Vaglum Per, McGlashan Thomas.* Reducing the duration of untreated first-episode psychosis: effects on clinical presentation. // *Archives of general psychiatry*. feb 2004. 61, 2. 143–50.
- Michie Patricia T.* What has MMN revealed about the auditory system in schizophrenia? // *International Journal of Psychophysiology*. 2001. 42, 2. 177–194.
- Michie Patricia T, Innes-Brown Hamish, Todd Juanita, Jablensky Assen V.* Duration mismatch negativity in biological relatives of patients with schizophrenia spectrum disorders // *Biological Psychiatry*. 2002. 52, 7. 749–758.
- Mumford D.* On the computational architecture of the neocortex II The role of cortico-cortical loops // *Biol. Cybern.* 1992. 66. 241–251.
- Näätänen R., Gaillard A.W.K., Mäntysalo S.* Early selective-attention effect on evoked potential reinterpreted // *Acta Psychologica*. 1978. 42, 4. 313–329.
- Näätänen R., Paavilainen P., Rinne T., Alho K.* The mismatch negativity (MMN) in basic research of central auditory processing: A review // *Clinical Neurophysiology*. 2007. 118, 12. 2544–2590.

- Näätänen R, Winkler I.* The concept of auditory stimulus representation in cognitive neuroscience. // *Psychological bulletin.* nov 1999. 125, 6. 826–59.
- Näätänen Risto.* The Mismatch Negativity // *Ear and Hearing.* 1995. 16, 1. 6–18.
- Näätänen Risto.* Mismatch negativity: clinical research and possible applications // *International Journal of Psychophysiology.* 2003. 48, 2. 179–188.
- Näätänen Risto, Kähkönen Seppo.* Central auditory dysfunction in schizophrenia as revealed by the mismatch negativity (MMN) and its magnetic equivalent MMNm: a review. // *The international journal of neuropsychopharmacology / official scientific journal of the Collegium Internationale Neuropsychopharmacologicum (CINP).* 2009. 12, 1. 125–135.
- Näätänen Risto, Pakarinen Satu, Rinne Teemu, Takegata Rika.* The mismatch negativity (MMN): Towards the optimal paradigm // *Clinical Neurophysiology.* 2004. 115, 1. 140–144.
- Näätänen Risto, Picton Terence.* The N1 Wave of the Human Electric and Magnetic Response to Sound: A Review and an Analysis of the Component Structure // *Psychophysiology.* jul 1987. 24, 4. 375–425.
- Niedermeyer Ernst, Da Silva Fernando Lopes.* *Electroencephalography : Basic Principles, Clinical Applications, and Related Fields.* Philadelphia, US: LWW, 2004.
- Nunez Paul L., Srinivasan Ramesh.* *Electric Fields of the Brain: The neurophysics of EEG.* New York: Oxford University Press, Inc., 2006. 2nd ed.
- Opitz Bertram, Rinne Teemu, Mecklinger Axel, Cramon D Yves von, Schröger Erich.* Differential contribution of frontal and temporal cortices to auditory change detection: fMRI and ERP results. // *NeuroImage.* 2002. 15, 1. 167–174.
- Os Jim van, Kapur Shitij, Kern RS, Al. et, Lieberman JA, Leboyer M.* Schizophrenia // *The Lancet.* aug 2009. 374, 9690. 635–645.
- Oskarsdóttir S, Vujic M, Fasth A.* Incidence and prevalence of the 22q11 deletion syndrome: a population-based study in Western Sweden. // *Archives of disease in childhood.* feb 2004. 89, 2. 148–51.
- Penny Will D., Stephan Klaas E., Daunizeau Jean, Rosa Maria J., Friston Karl J., Schofield Thomas M., Leff Alex P.* Comparing families of dynamic causal models // *PLoS Computational Biology.* 2010. 6, 3. e1000709.

- Picton Terence W.* Human Auditory Evoked Potentials. 2010.
- Plourde Gilles, Stapells David R., Picton Terence W.* The Human Auditory Steady-State Evoked Potentials // *Acta Oto-Laryngologica*. jul 1991. 111, sup491. 153–160.
- Pratt Hillel.* Sensory ERP Components. 2011. 1–35.
- Purcell Shaun M, Wray Naomi R, Stone Jennifer L, Visscher Peter M, O'Donovan Michael C, Sullivan Patrick F, Sklar Pamela.* Common polygenic variation contributes to risk of schizophrenia and bipolar disorder. // *Nature*. aug 2009. 460, 7256. 748–52.
- Rao R P, Ballard D H.* Predictive coding in the visual cortex: a functional interpretation of some extra-classical receptive-field effects. // *Nature neuroscience*. 1999. 2, 1. 79–87.
- Rass Olga, Forsyth Jennifer K., Krishnan Giri P., Hetrick William P., Klaunig Mallory J., Breier Alan, O'Donnell Brian F., Brenner Colleen A.* Auditory steady state response in the schizophrenia, first-degree relatives, and schizotypal personality disorder // *Schizophrenia Research*. 2012. 136, 1. 143–149.
- Rihs Tonia a, Tomescu Miralena I, Britz Juliane, Rochas Vincent, Custo Anna, Schneider Maude, Debbané Martin, Eliez Stephan, Michel Christoph M.* Altered auditory processing in frontal and left temporal cortex in 22q11.2 deletion syndrome: a group at high genetic risk for schizophrenia. // *Psychiatry research*. 2013. 212, 2. 141–9.
- Rinne T, Alho K, Ilmoniemi R.J, Virtanen J, Näätänen R.* Separate time behaviors of the temporal and frontal mismatch negativity sources // *Neuroimage*. 2000. 12, 1. 14–19.
- Roach Brian J., Mathalon Daniel H.* Event-related EEG time-frequency analysis: An overview of measures and an analysis of early gamma band phase locking in schizophrenia // *Schizophrenia Bulletin*. 2008. 34, 5. 907–926.
- Management of genetic syndromes. // . New York: Hoboken, N.J.: J. Wiley, 2005. 2. ed. 615–32.
- Robin Nathaniel H, Shprintzen Robert J.* Defining the clinical spectrum of deletion 22q11.2. // *The Journal of pediatrics*. jul 2005. 147, 1. 90–6.
- Rosburg Timm, Boutros Nash N, Ford Judith M.* Reduced auditory evoked potential component N100 in schizophrenia—a critical review. // *Psychiatry research*. dec 2008. 161, 3. 259–74.

- Saha Sukanta, Chant David, Welham Joy, McGrath John.* A systematic review of the prevalence of schizophrenia. // *PLoS medicine.* may 2005. 2, 5. e141.
- Schmock Henriette, Vangkilde Anders, Larsen Kit Melissa, Fischer Elvira, Birknow Michelle Rosgaard, Jepsen Jens Richardt Møllegaard, Olesen Charlotte, Skovby Flemming, Plessen Kerstin Jessica, Mørup Morten, Hulme Ollie, Baaré William Frans Christiaan, Didriksen Michael, Siebner Hartwig Roman, Werge Thomas, Olsen Line.* The Danish 22q11 research initiative. // *BMC psychiatry.* jan 2015. 15, 1. 220.
- Schneider Maude, Debbané Martin, Bassett Anne S, Chow Eva W C, Fung Wai Lun Alan, Bree Marianne van den, Al. et.* Psychiatric disorders from childhood to adulthood in 22q11.2 deletion syndrome: results from the International Consortium on Brain and Behavior in 22q11.2 Deletion Syndrome. // *The American journal of psychiatry.* jun 2014. 171, 6. 627–39.
- Shipp Stewart.* Structure and function of the cerebral cortex // *Current Biology.* 2007. 17, 12. R443–R449.
- Sivarao Digavalli V.* The 40-Hz auditory steady-state response a selective biomarker for cortical NMDA function. // *Annals of the New York Academy of Sciences.* may 2015. 1344. 27–36.
- Sivarao Digavalli V, Chen Ping, Senapati Arun, Yang Yili, Fernandes Alda, Benitez Yulia, Whiterock Valerie, Li Yu-Wen, Ahlijanian Michael K.* 40 Hz Auditory Steady-State Response Is a Pharmacodynamic Biomarker for Cortical NMDA Receptors. // *Neuropsychopharmacology.* aug 2016. 41, 9. 2232–40.
- Sohal Vikaas S, Zhang Feng, Yizhar Ofer, Deisseroth Karl.* Parvalbumin neurons and gamma rhythms enhance cortical circuit performance. // *Nature.* jun 2009. 459, 7247. 698–702.
- Spencer Kevin M, Niznikiewicz Margaret A, Nestor Paul G, Shenton Martha E, McCarley Robert W.* Left auditory cortex gamma synchronization and auditory hallucination symptoms in schizophrenia. // *BMC neuroscience.* jan 2009. 10, 1. 85.
- Spencer Kevin M., Salisbury Dean F., Shenton Martha E., McCarley Robert W.*  $\gamma$ -Band Auditory Steady-State Responses Are Impaired in First Episode Psychosis // *Biological Psychiatry.* sep 2008. 64, 5. 369–375.
- Stefansson H, Rujescu D, Cichon S.* Large recurrent microdeletions associated with schizophrenia // *nature.* 2008. 455. 232–236.

- Stephan K. E., Penny W. D., Moran R. J., Ouden H. E M den, Daunizeau J., Friston K. J.* Ten simple rules for dynamic causal modeling // *NeuroImage*. 2010. 49, 4. 3099–3109.
- Stephan Klaas E, Baldeweg Torsten, Friston Karl J.* Synaptic plasticity and dysconnection in schizophrenia. // *Biological psychiatry*. may 2006. 59, 10. 929–39.
- Stephan Klaas Enno, Penny Will D., Daunizeau Jean, Moran Rosalyn J., Friston Karl J.* Bayesian model selection for group studies // *NeuroImage*. 2009. 46, 4. 1004–1017.
- Stone JL, O'Donovan MC, Gurling H.* Rare chromosomal deletions and duplications increase risk of schizophrenia // *Nature*. 2008.
- Sussman Elyse, Winkler István.* Dynamic sensory updating in the auditory system // *Cognitive Brain Research*. 2001. 12, 3. 431–439.
- Symond Matthew P, Symond Matthew B, Harris Anthony W F, Gordon Evian, Williams Leanne M.* "Gamma synchrony" in first-episode schizophrenia: a disorder of temporal connectivity? // *The American journal of psychiatry*. mar 2005. 162, 3. 459–65.
- Tallon-Baudry Catherine, Bertrand Olivier, Delpuech Claude, Pernier Jacques.* Stimulus Specificity of Phase-Locked and Non-Phase-Locked 40 Hz Visual Responses in Human // *Journal of Neuroscience*. 1996. 16, 13.
- Thuné Hanna, Recasens Marc, Uhlhaas Peter J.* The 40-Hz Auditory Steady-State Response in Patients With Schizophrenia: A Meta-analysis. // *JAMA psychiatry*. oct 2016.
- Traub R D, Cunningham M O, Gloveli T, LeBeau F E N, Bibbig A, Buhl E H, Whittington M A.* GABA-enhanced collective behavior in neuronal axons underlies persistent gamma-frequency oscillations. // *Proceedings of the National Academy of Sciences of the United States of America*. sep 2003. 100, 19. 11047–52.
- Uhlhaas Peter J, Singer Wolf.* Abnormal neural oscillations and synchrony in schizophrenia. // *Nature reviews. Neuroscience*. 2010. 11, 2. 100–113.
- Umbrecht Daniel, Koller René, Schmid Liselotte, Skrabo Anja, Grübel Claudia, Huber Theo, Stassen Hans.* How specific are deficits in mismatch negativity generation to schizophrenia? // *Biological psychiatry*. jun 2003. 53, 12. 1120–31.



- Umbricht Daniel, Krljesb Sanya.* Mismatch negativity in schizophrenia: A meta-analysis // *Schizophrenia Research.* 2005. 76, 1. 1–23.
- Vangkilde Anders, Olsen Line, Hoeffding Louise K., Pedersen Carsten B., Mortensen Preben B., Werge Thomas, Trabjerg Betina.* Schizophrenia Spectrum Disorders in a Danish 22q11.2 Deletion Syndrome Cohort Compared to the Total Danish Population—A Nationwide Register Study // *Schizophrenia Bulletin.* may 2016. 42, 3. 824–831.
- Varela Francisco, Lachaux Jean-Philippe, Rodriguez Eugenio, Martinerie Jacques.* The brainweb: Phase synchronization and large-scale integration // *Nature Reviews Neuroscience.* apr 2001. 2, 4. 229–239.
- Wacongne C., Changeux J.-P., Dehaene S.* A Neuronal Model of Predictive Coding Accounting for the Mismatch Negativity // *Journal of Neuroscience.* mar 2012. 32, 11. 3665–3678.
- Weickert Cynthia S, Weickert Thomas W, Pillai Anil, Buckley Peter F, Weickert Cynthia S., Weickert Thomas W., Pillai Anil, Buckley Peter F.* Biomarkers in schizophrenia: a brief conceptual consideration. // *Disease markers.* 2013. 35, 1. 3–9.
- Winkler I, Karmos G, Näätänen R.* Adaptive modeling of the unattended acoustic environment reflected in the mismatch negativity event-related potential. // *Brain research.* dec 1996. 742, 1-2. 239–52.
- Zarchi Omer, Carmel Miri, Avni Chen, Attias Josef, Frisch Amos, Michaelovsky Elena, Patya Miriam, Green Tamar, Weinberger Ronnie, Weizman Abraham, Gothelf Doron.* Schizophrenia-like neurophysiological abnormalities in 22q11.2 deletion syndrome and their association to COMT and PRODH genotypes. // *Journal of psychiatric research.* nov 2013. 47, 11. 1623–9.