



Relationships in Indoor/Outdoor Air Pollution

Roed, Jørn

Publication date:
1985

Document Version
Publisher's PDF, also known as Version of record

[Link back to DTU Orbit](#)

Citation (APA):
Roed, J. (1985). *Relationships in Indoor/Outdoor Air Pollution*. Risø National Laboratory. Risoe-M No. 2476

General rights

Copyright and moral rights for the publications made accessible in the public portal are retained by the authors and/or other copyright owners and it is a condition of accessing publications that users recognise and abide by the legal requirements associated with these rights.

- Users may download and print one copy of any publication from the public portal for the purpose of private study or research.
- You may not further distribute the material or use it for any profit-making activity or commercial gain
- You may freely distribute the URL identifying the publication in the public portal

If you believe that this document breaches copyright please contact us providing details, and we will remove access to the work immediately and investigate your claim.

Risø-M-2476

RELATIONSHIPS IN INDOOR/OUTDOOR AIR POLLUTION

Jørn Roed

Abstract. Beryllium-7 and sulphurhexafluorid has been used as tracers in measurements designed to enable an estimate of the ratio of the outdoor to indoor time-integrated concentration for aerosols and non-reactive gasses of outdoor origin with a special reference to the reduction in inhalation dose that can be achieved by staying indoors during a pollution episode, especially a reactor accident.

The effect of operating a vacuum cleaner during the pollution episode and airing shortly after is also investigated.

Earlier relevant literature is reviewed and shows good agreement with the results in this study. Protection factor from 1-12 has been found.

INIS descriptors: AEROSOLS; AIR FILTERS; AIR POLLUTION; AIR QUALITY; BUILDINGS; CONTAMINATION; DEPOSITION; CORRELATIONS; INDOOR AIR POLLUTION; INHALATION; MATHEMATICAL MODELS; PARTICLES; RADIOACTIVE CLOUDS; REMEDIAL ACTION; REVIEWS; TRACER TECHNIQUES; VENTILATION.

The work was part of the EEC Radiation Protection Programme and done under a subcontract with Association Euratom-C.E.A. No. SC-014-BIO-F-423-DK(SD) under contract No. BIO-F-423-81-F.

January 1985

Risø National Laboratory, DK-4000 Roskilde, Denmark

Risø Repro 1985

ISBN 87-550-1072-5

ISSN 0418-6435

CONTENTS

	Page
1. INTRODUCTION	5
2. SURVEY OF RELEVANT STUDIES	6
2.1. Classification	6
2.2. Reactive matter	7
2.3. Particles	9
2.4. Non-reactive gas	14
3. EXPERIMENTAL PART	15
3.1. Introduction	15
3.2. Non-reactive gasses	18
3.3. Measurement of transport coefficient	22
3.4. Intrusion of a non-reactive gas in dwellings	22
3.5. Model for depositing aerosols	24
3.6. Tracers used in measurements on non-reactive particles	26
3.7. Particles concentration measurements	26
3.8. Model change because of the influence of the measuring	27
3.9. The model used in the measuring situation	27
3.10. Mechanical cleaning of polluted air	34
4. CONCLUSION	39
REFERENCES	40

1. INTRODUCTION

The object of this investigation is to estimate to what extent the filtering effect of cracks, crevices and pores, as well as any possible deposition on floors, walls and furnishings, can reduce inhalation doses to people remaining inside buildings during a large, hypothetical reactor accident. Even a small reduction would be of great importance, because the dose from inhalation is the dominating component of the total dose from the cloud passage (Becher et al. 1981)

Any pollution of inhaled air means that the polluting material will be taken up by the lungs in an amount proportional to the inhalation rate and the time-integrated concentration of the pollution in the air.

People inside buildings will normally obtain some protection against air pollution originating outside. This is the result of physical and chemical processes. Firstly, some of the pollution will be removed by filtration in the cracks, crevices and pores through which air penetrates into buildings. Thereby, the pollution concentration will be less indoors than outdoors. Secondly, some of the pollution that penetrates into the inside may be deposited on floors, walls, ceilings and furniture. This will contribute toward reducing the concentration in indoor air. Finally, conversion processes, such as radioactive decay, may also contribute toward this reduction.

When dealing with a relatively short-term air pollution episode - such as a reactor accident - it is possible to achieve a further reduction of the time-integrated concentration, and thus of the inhalation doses, by deliberately controlling ventilation in rooms (e.g. by closing and opening windows). Dis-

regarding the factors mentioned above the total time integrated concentration resulting from the passage of a pollution cloud will be the same, indoors and outdoors, provided that the air exchange rate remains constant regardless of its magnitude. Even though the concentration builds up more slowly indoors than outdoors, it will, on the other hand, decrease more slowly too. As a result total indoor air pollution is simply made to be of longer duration than outdoor.

This means, however, that the integrated concentration indoors can be reduced by increasing the air exchange rate (e.g., by opening the windows) after the pollution cloud has passed by. The degree of reduction that can be achieved in this manner depends on the natural air exchange rate in the building in question. The less the natural air exchange rate, the greater the reduction. In contrast, of course, the time-integrated concentration can be increased by reducing the air exchange rate (e.g., by closing any windows that may be open) when the cloud has passed.

2. SURVEY OF RELEVANT STUDIES

2.1. Classification

Most studies of the indoor-outdoor air pollution relationship have been carried out to find this relationship while people continue their normal habits of, for instance, heating and ventilation.

A pollutant such as sulphur dioxide, can have an internal source apart from the external source. In that case, it is of limited interest here where the aim is to find the relationship with the most limited ventilation (windows and doors closed and forced ventilation shut-off).

The relationship is very dependent on the physical-chemical form of the pollutant. In that respect, it is convenient to classify the pollutants in three categories: reactive matter, non-reactive particles, and non-reactive gasses.

2.2. Reactive matter

The Windscale study

The reactor accident at Windscale in October 1957 offered a unique opportunity of studying the protective effect of buildings, as it involved a radioactive aerosol that possessed the characteristics expected in a reactor accident and which was sufficiently concentrated to make it possible to make accurate measurements of its effects, also at larger distances. (Megaw 1961).

One week after the accident the deposition of ^{131}I was measured indoors and outdoors in an office building at Drigg, located about 6 km from Windscale, and in a two-storey stone-built house at High Saltcoats, located 9 km from Windscale. Both buildings lay in the direction of the smoke plume, and neither was in use during the period of time in question. The house in High Saltcoats had sash windows and six chimneys. Some of the windows in the office building at Drigg were open during the accident. Because of the workload on the technical staff in connection with the accident, measurements were started a week after the incident and it was thus not possible to measure the indoor and outdoor exposure integrals such as would have been desirable. For this reason the Drigg and Saltcoats measurements were later supplemented by an experiment carried out at the old Harwell airbase. Here there was a wooden hut, described as relatively newly erected, well maintained and with tight-fitting windows and reasonably

tight-fitting doors. This experiment involved the release of radioactive iodine at a distance of approximately 20 m from the hut. Measurements were then made of the deposition and the indoor and outdoor exposure integrals. In addition, the air exchange in the hut was measured before each series of experiments. Finally, the exposure integrals for an inactive aerosol composed of Aitken nuclei were also measured.

From the experimental results the author concluded that the iodine inhaled by people inside the building may be 20-80 per cent of that outside, depending on wind velocity and direction. This study was critically reviewed by Gjørup and Roed (1980). They concluded that the house at High Saltcoast rather afforded a protection factor with respect to the inhalation dose for iodine-131 of 6 or perhaps somewhat more.

SO₂ in Rotterdam homes

Biersteker et al (1965) sampled air in the living room of 60 Rotterdam homes and simultaneously outside the homes. The sampling was done in the winter season and although people continued their normal habits, of e.g. ventilating the living room during the study this ventilation was at least not continuous in the winter season. The results of the study are summarized in the following tables: 2.2.1. and 2.2.2.

Table 2.2.1. SO₂ concentration in homes of different age.

Year of construction	SO ₂ indoors (as % of outdoors)
-1919	30.0
1920-1939	17.7
1940-1959	16.8
1960+	5.9

Table 2.2.2. SO₂ concentrations in homes with different heating systems

Heating system	SO ₂ indoors (as % of outdoors)
central heating	12
oil heaters	17
coal heaters	20
gas heaters	33

As is shown in Table 2.2.1. the SO₂ concentration is lowest in new houses. This is probably due to the better filtration provided by the new houses compared with the older ones.

Table 2.2.2. shows that houses with central heating offer the best protection against SO₂-pollution. This is probably because houses with central heating have a limited source of SO₂ inside the house in comparison with houses with the other types of heaters shown in Table 2.2.2.

In houses with central heating SO₂ can be considered as a pollutant of mainly outdoor origin. The measurements of these houses are therefore of relevance to our study, and we can conclude that Rotterdam homes offer a mean protection factor of at least 8 for reactive air pollution of outside origin, when windows and doors are closed.

2.3. Particles

The Hartford, Connecticut study

In this study (Ycom et al 1971) suspended particulate samples were collected for a 12-hour day and night period. Four sampling points were selected for each structure, two outside and two

inside. Three basic types of structures were used for the study: public buildings, office buildings, and private homes. A pair of buildings of each type was sampled simultaneously. Structures in each pair were essentially similar, except for one design feature which might affect the exposure to and the penetration of certain pollutants.

Public Buildings. The pair of public buildings used in the study were the Hartford Public Library, built as an air-tight structure over a four-lane highway, the Hartford City Hall, which is located to the north of the library and is separated from it by a busy street. Neither building is air-conditioned, and both are of masonry construction.

Office Buildings. The pair of office buildings are located in Constitution Plaza, an urban renewal area in downtown Hartford. One of the buildings is a six-storey structure at 250 Constitution Plaza (250 CP), built directly over a fivelevel, partially underground parking garage and connected to the garage by stairwells and elevator shafts. The other office building is a 16-storey structure at 100 CP, not built over a parking garage. Both buildings are air-conditioned and therefore have no open windows. To prevent infiltration of air from the parking garage, an attempt was made to pressurize the smaller office building by returning or recirculating significantly less air than the air-conditioning system provides for the building.

Private Homes. Both homes are located in East Hartford, in the midst of an expressway interchange network. One home is located on Carroll Road, to the north of Interstate Highway 84, and the other on Blinn Street, on the opposite side of the same east-west road. Neither house is air-conditioned.

The results for suspended matter are shown in the Table 2.3.

Table 2.3.

Summary of suspended particulate matter results. (Concentration, $\mu\text{g}/\text{m}^3$, indoor/outdoor ratio, dimensionless.)

Location	Sampling point	Summer		Fall		Winter	
		Day	Night	Day	Night	Day	Night
Library	Far Outdoor	132	82	150	100	425	189
	Near Outdoor	98	66	115	77	293	130
	Near Indoor	70	45	61	45	74	51
	Far Indoor	66	43	57	44	67	45
	Indoor/Outdoor	0.50	0.52	0.38	0.44	0.16	0.26
City Hall	Far Outdoor	153	78	133	94	327	168
	Near Outdoor	145	76	128	83	285	147
	Near Indoor	78	52	87	50	107	53
	Far Indoor	78	49	82	50	87	51
	Indoor/Outdoor	0.51	0.63	0.62	0.53	0.27	0.30
100 CP	Far Outdoor	104	93	48	38	124	81
	Near Outdoor	118	98	47	40	137	89
	Near Indoor	49	49	34	24	39	41
	Far Indoor	50	46	36	27	38	39
	Indoor/Outdoor	0.48	0.49	0.75	0.71	0.31	0.48
250 CP	Far Outdoor	124	109	66	46	183	97
	Near Outdoor	115	102	58	44	163	98
	Near Indoor	57	67	38	24	57	31
	Far Indoor	56	60	38	23	60	32
	Indoor/Outdoor	0.45	0.55	0.58	0.50	0.33	0.33
Blinn Street	Far Outdoor	79	65	96	74	114	86
	Near Outdoor	87	65	93	70	109	79
	Near Indoor	67	51	52	42	45	32
	Far Indoor	70	56	54	45	49	35
	Indoor/Outdoor	0.87	0.86	0.56	0.61	0.43	0.41
Carroll Road	Far Outdoor	66	56	78	61	103	85
	Near Outdoor	60	49	81	60	116	81
	Near Indoor	73	47	73	37	44	32
	Far Indoor	76	47	76	38	53	33
	Indoor/Outdoor	1.15	0.84	0.97	0.62	0.51	0.39

Most interesting for this survey are the values for indoor/outdoor concentrations in the winter season, where the ventilation rate is limited.

It can be concluded that the structure measured offers a protection for inhalation of suspended particulate matter of outdoor origin of at least a factor of 2.5 for the private homes, a factor of 2-3 for the offices, and a factor of 3-5 for the public buildings.

The Pittsburgh study

The purpose of this study was to evaluate the protection factor against inhalation of dust of outdoor origin for people who are indoors. The method consisted of taking filter samples

of air and determining the content of collected particles of calcium, iron zinc, lead and bromine by means of X-ray fluorescence analysis. (Alzona et al. 1979)

The particles in question are known to be principally of outdoor origin. The particle sizes were not measured in connection with the study, but reference is made to other investigations, where they were found typically to be the following: calcium 0.65-20 micrometer; zinc 0.65-29 micrometer; lead 0.1-0.65 micrometer; bromine 0.1-0.65 micrometer. The lead and bromine associated with particles originate chiefly from automobile exhaust gas, and the concentration varies widely during the course of a day. The iron and zinc levels in Pittsburgh are much higher than in other areas, which shows that they are principally of industrial origin. Calcium is an important component of fly ash, and it is also released when using limestone in the production of steel.

The ratio of outdoor to indoor concentrations in equilibrium was measured in ten indoor locations of widely differing character (two of them were cars). The greatest value for this ratio was found in a 10 m² room without windows in a new university building in Pittsburgh, and it is stated to have been greater than 10 for all types of pollution measured (iron, lead and bromine). For the other nine rooms, the average for bromine was 2.79; for lead 2.38; for iron 4.17; for zinc (only five rooms) 2.44; and for calcium (only four rooms) 10. The lowest value, 1.43, was found in a 30 m² large bedroom with eight windows.

One of the rooms - a 12 m² office in an old university building with a large six-paned window, of which two sections could be opened - was investigated in greater detail. It was measured as it was (case J), with plastic foil over the window (case K), with plastic foil covering all surfaces (case N), and with plastic foil covering all surfaces except the window

(case P). These experiments seem to show that the outdoor pollution exclusively, or almost exclusively, penetrated through the window. In case J the relation between the outdoor and the indoor exposure was 10 for calcium, 5.88 for iron, 1.92 for zinc, 2.04 for lead, and 2.78 for bromine. The experimenters corrected these values for background concentrations indoors on the basis of case N, and thereby found a protection factor of between 3 and 20, but they also point out that the protection factor becomes much greater for calcium, iron and zinc if corrections are made on the basis of case K. Relating to case K, the dose does not significantly alter the factor for lead and bromine, which was 2.94 and 7.69, respectively.

The Danish study

The first series of measurements on houses in Denmark was reported by Gjørup and Roed in 1980. In this study the beryllium-7 isotope was used as a tracer. The particles to which beryllium-7 are attached are mainly non-reactive small particles.

From the limited material in this study it was concluded that the protection factor for inhalation of particulate matter could be about 10.

It must be emphasized that the indoor-outdoor relationship found by these measurements was strongly influenced by the vacuum cleaner operated in the sampling procedure so the measured effect was a combination of the filtering effect of the houses and the filtering effect of the vacuum cleaner.

2.4. Non-reactive gas

It can easily be shown that for a non-reactive gas pollutant the time-integrated concentration in- and out-of-doors will be equal if the ventilation rate of the house stays unchanged during the cloud passage and some time after.

A reduction in the time-integrated concentration can be obtained by increasing the ventilation rate of the house by opening the windows and doors just after the cloud has passed.

3. EXPERIMENTAL PART

3.1. Introduction

A serie of measurements in Danish houses have been made.

The results are described in further detail in (Roed et. al. 1985).

As mentioned before, it is convenient to classify the pollutants into different groups: non-reactive gases, non-reactive particles and reactive materials. These three groups behave differently in passing from the outdoors to indoors. The principle for the different developments in concentration for the three groups is shown as a function of time in Fig. 3.1, assuming the pollution has the same concentration out of doors during the time the pollution episode takes place.

Radioactive noble gases are examples of non-reactive gases. For these the development of the indoor concentration is determined solely by the air exchange rate for the dwelling and the concentration out of doors. This is demonstrated by curve 1 in Fig. 3.1.

In case of a major reactor accident, fission products in the form of particulate matter could be released and a large number of the particles would be non-reactive. In this case there will be a filtering effect of the houses; deposition could also reduce the indoor concentration. This is illustrated on curve 2 in Fig. 3.1.

In case of a major accident part of the pollution, e.g. I_2 , could be released as reactive matter. This reactive matter is assumed to be filtered easier and have a greater deposition velocity than non-reactive matter. This is illustrated in curve 3 in Fig. 3.1.

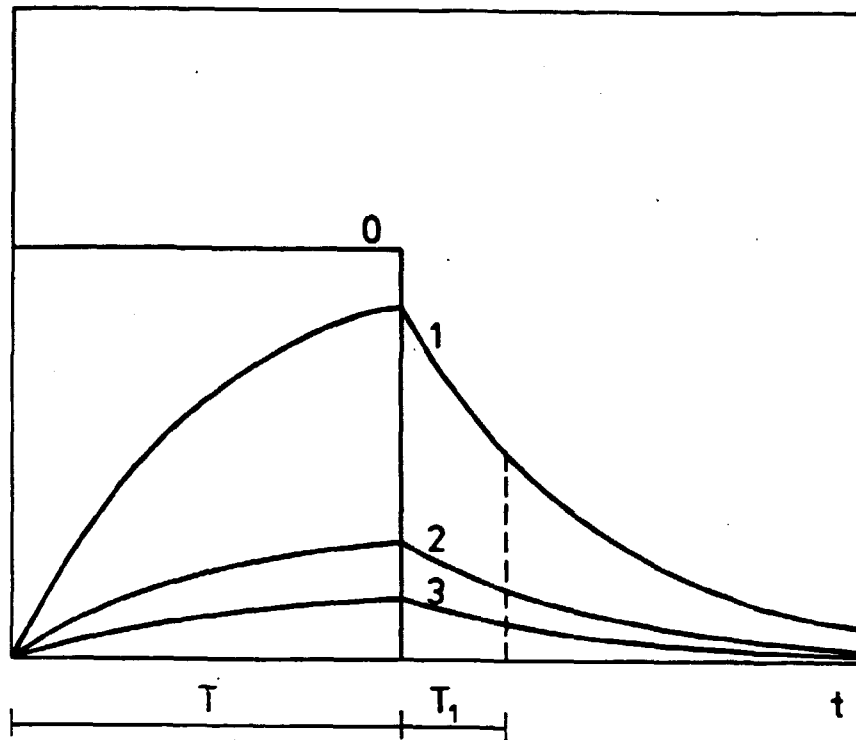

Fig. 3.1. Idealized concentration curves.

- 0 : Outdoors.
- 1 : Indoors for non-reactive gases.
- 2 : Indoors for non-reactive particles.
- 3 : Indoors for reactive connections.

As mentioned above the indoor exposure integral can be reduced also by ventilating the dwelling after cloud passage. This is illustrated by cutting-off to the time $T + T_1$, on the idealized curves in Fig. 3.1. The effect is of course greatest when airing takes place shortly after the pollution cloud has passed.

Seventeen dwellings were examined and chosen to be representative for the Danish standard of houses. The dwellings consisted of 14 single-family houses and 3 apartments.

During the measurements all outer doors and windows as well as forced ventilation systems were closed.

In 15 of the 17 dwellings most of the inside doors were closed during the measurement.

In addition to this the air exchange rate was measured for all the dwellings with all inner doors opened.

The quantity we wish to determine is the ratio of the exposure integral in a given room to that outside the house. This is called the transfer factor

$$D_{oi} = \frac{\int N_i(t) dt}{\int N_o(t) dt} \quad 3.1.$$

where D_{oi} is the transfer factor from outside (o) to room no i. $N_i(t)$ and $N_o(t)$ are, respectively, the concentrations of pollution in room i and outside the dwelling at time t.

To simplify the calculation, we restrict ourselves to the idealized case of a cloud of constant concentration N_o and duration T.

so that $\int_0^T \dot{N}_0(t) dt = N_0 T$.

After the cloud has passed there will be a significant indoor concentration for some time until eventually an airing takes place.

For non-reactive gases D_{oi} will be 1 if no airing is carried out.

3.2. Non-reactive gasses

First, non-reactive pollution will be considered.

The principle of air-exchange is illustrated in Fig. 3.2. in the case of a dwelling with three rooms.

Let N_0 be the outdoor concentration, V_i the volume of room i , a_{i0} the fraction of the volume of room i that passes directly to the outside per hour, a_{oi} the fraction of the volume of room i that is supplied directly from the outside, per hour, and a_{ij} the fraction of the volume of room i that is supplied directly from room no j per hour. For the three fractions the following continuity equation is valid:

$$\frac{dN_1(t)}{dt} = -(a_{10} + a_{12} + a_{13})N_1(t) + a_{01}N_0 + a_{21} \frac{V_2}{V_1} N_2(t) + a_{31} \frac{V_3}{V_1} N_3(t)$$

$$\frac{dN_2(t)}{dt} = -(a_{20} + a_{21} + a_{23})N_2(t) + a_{02}N_0 + a_{12} \frac{V_1}{V_2} N_1(t) + a_{32} \frac{V_3}{V_2} N_3(t) \quad 3.2.1.$$

$$\frac{dN_3(t)}{dt} = -(a_{30} + a_{31} + a_{32})N_3(t) + a_{03}N_0 + a_{13} \frac{V_1}{V_3} N_1(t) + a_{23} \frac{V_2}{V_3} N_2(t)$$

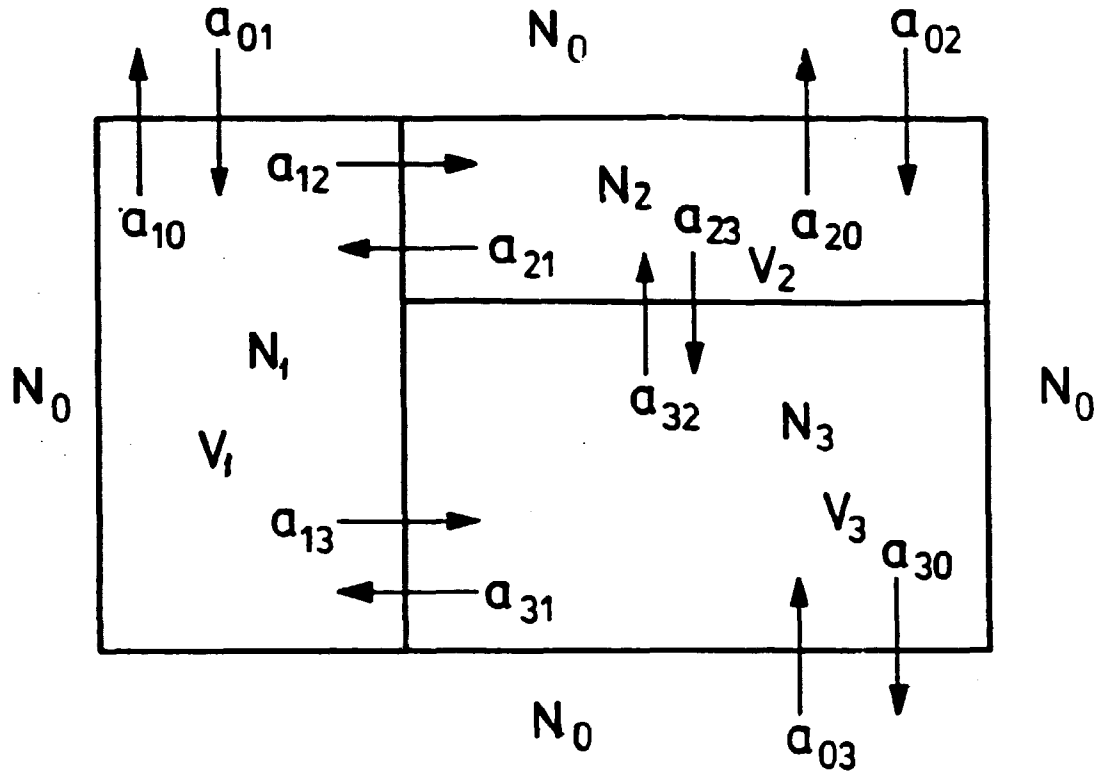

Fig. 3.2. Three-room-model for air exchange.

N_0 is the concentration of tracer outdoors.

N_i is the concentration of tracer in room i .

V_i is the volume of room i .

a_{i0} is the ratio between the air-volume, which per time-unit moves out to the open air from room i , and the volume V_i of the room.

a_{0i} is the ratio between the air-volume, which per time-unit moves into the room i from the open air, and the room volume V_i .

a_{ij} is the ratio between the air-volume, which per time-unit moves to the room j from room i and the volume of the room i , V_i .

In the case of $N_0 = 0$ this equation can be rewritten as

$$\frac{dN_1(t)}{dt} = b_{11} \cdot N_1 + b_{21} \cdot N_2 + b_{31} \cdot N_3$$

$$\frac{dN_2(t)}{dt} = b_{12} \cdot N_1 + b_{22} \cdot N_2 + b_{32} \cdot N_3 \quad 3.2.2.$$

$$\frac{dN_3(t)}{dt} = b_{13} \cdot N_1 + b_{23} \cdot N_2 + b_{33} \cdot N_3$$

where $b_{11} = -(a_{10} + a_{12} + a_{13})$, $b_{22} = -(a_{20} + a_{12} + a_{13})$, etc.

and $b_{21} = \frac{a_1 \cdot V_1}{V_2} (N_2 t)$, b_{31} , etc.

On extending the equation to N rooms, this can be written in vector-matrix form

as

$$\frac{d}{dt} \begin{Bmatrix} N_1 \\ N_2 \\ \cdot \\ \cdot \\ N_n \end{Bmatrix} = \begin{Bmatrix} b_{11} & b_{21} & \dots & b_{n1} \\ b_{12} & b_{22} & \dots & b_{n2} \\ \cdot & \cdot & \cdot & \cdot \\ \cdot & \cdot & \cdot & \cdot \\ b_{1n} & b_{2n} & \dots & b_{nn} \end{Bmatrix} \begin{Bmatrix} N_1 \\ N_2 \\ \cdot \\ \cdot \\ N_n \end{Bmatrix} \quad 3.2.3.$$

which also can be written as

$$\frac{d\bar{N}}{dt} = \bar{B} \cdot \bar{N}; \quad 3.2.4.$$

the solution to these equations is formally

$$\bar{N} = e^{\bar{B} \cdot t} \quad 3.2.5.$$

This brings us to the eigenvalue problem

$$\bar{B} \cdot \bar{C}_i = \lambda_i \cdot \bar{C}_i \quad 3.2.6.$$

Here, we seek the eigenvalues λ_i to the quadratic matrix \bar{B} and the eigenvectors \bar{C}_i connected to these values. The equation can also be written

$$(\bar{B} - \lambda_i \cdot \bar{E})\bar{C}_i = 0 \quad 3.2.7.$$

or written out as

$$\begin{Bmatrix} b_{11} - \lambda_i & & b_{n1} \\ & \cdot & \\ & & \cdot \\ b_{1n} & & b_{nn} - \lambda_i \end{Bmatrix} \begin{Bmatrix} C_{i1} \\ C_{i2} \\ \vdots \\ C_{in} \end{Bmatrix} = 0 \quad 3.2.8.$$

the condition for real solutions is that the reduction determinant for the matrix $(\bar{B} - \lambda_i \cdot \bar{E})$ is equal to zero. This is

$$\begin{vmatrix} b_{11} - \lambda_i & b_{21} & \dots & b_{n1} \\ b_{12} & b_{22} - \lambda_i & \dots & b_{n2} \\ \vdots & \vdots & \ddots & \vdots \\ b_{1n} & b_{2n} & \dots & b_{nn} - \lambda_i \end{vmatrix} = 0 \quad 3.2.9.$$

This equation can be written as a polynomial in λ_i

$$D(\lambda_i) = (-\lambda_i)^n + D_1(-\lambda_i)^{n-1} + \dots + D_n = 0 \quad 3.2.10.$$

this characteristic equation has n roots, $\lambda_1, \lambda_2, \dots, \lambda_n$.

In the case of transport coefficients for houses the root has been shown to be real.

From the equation the eigenvector is found for each eigenvalue.

The solution can then be found as

$$\phi_i = \bar{C}_i \cdot e^{\lambda_i \cdot t} \quad 3.2.11.$$

3.3. Measurement of transport coefficient

The measurements needed to determine the actual transport coefficient matrix \bar{B} , are made in the following way:

A certain concentration of SF₆, a non-depositing gas, is imported to a room in the house, each room in turn.

Both the falling concentration in the dosage room and the rising concentrations in the other rooms are measured as a function of time. From these data, connected values of $\frac{dN_i}{dt}$ and N_i can be found, and by inserting them in the expression the transport coefficient matrix can be constructed by means of solutions of the equations.

The solution system can then be written as

$$\begin{aligned}
 N_1(t) &= g_1 \cdot C_{11} \cdot e^{\lambda_1 t} + g_2 \cdot C_{21} \cdot e^{\lambda_2 t} + \dots + g_n \cdot C_{n1} \cdot e^{\lambda_n t} \\
 N_2(t) &= g_1 \cdot C_{12} \cdot e^{\lambda_1 t} + g_2 \cdot C_{22} \cdot e^{\lambda_2 t} + \dots + g_n \cdot C_{n2} \cdot e^{\lambda_n t} \\
 &\vdots \\
 &\vdots \\
 &\vdots \\
 N_n(t) &= g_1 \cdot C_{1n} \cdot e^{\lambda_1 t} + g_2 \cdot C_{2n} \cdot e^{\lambda_2 t} + \dots + g_n \cdot C_{nn} \cdot e^{\lambda_n t}
 \end{aligned} \tag{3.3}$$

where $N_i(t)$ is the concentration in room i to the time t , $\lambda_1 \dots \lambda_n$ are the eigenvalues ($C_{11}, C_{12} \dots C_{1n}$) the eigenvector connected to the different λ_i , and $g_1, g_2 \dots g_n$ are constants prescribed by the starting conditions.

3.4. Intrusion of a non-reactive gas in dwellings

The solution system is valid only in a situation where the concentration of the pollutant is 0 outside the dwelling.

In the normal pollution situation the pollutant gas will arrive at the dwelling at a certain time t_a . In the following, t_a is given the value 0.

Firstly, we assume that there is a constant concentration outside the dwelling for the time $t > 0$.

The following expression for the concentration indoor can then be set up

$$\frac{dN}{dt} = B \cdot N + H \quad 3.4.1.$$

where H is a vector with constant elements. It expresses the part of the air in room No i that is supplied directly from outside per hour.

The solution to this system can be written as

$$\begin{aligned} N_1 &= g_1 \cdot C_{11} \cdot e^{\lambda_1 t} + g_2 \cdot C_{21} \cdot e^{\lambda_2 t} + g_n \cdot C_{n1} \cdot e^{\lambda_n t} + d \\ N_2 &= g_1 \cdot C_{12} \cdot e^{\lambda_1 t} + g_2 \cdot C_{22} \cdot e^{\lambda_2 t} + g_n \cdot C_{n2} \cdot e^{\lambda_n t} + d \\ &\vdots \\ N_n &= g_1 \cdot C_{1n} \cdot e^{\lambda_1 t} + g_2 \cdot C_{2n} \cdot e^{\lambda_2 t} + g_n \cdot C_{nn} \cdot e^{\lambda_n t} + d \end{aligned} \quad 3.4.2.$$

where g_1, g_2, \dots, g_n and d are prescribing constants found from the starting conditions.

We have calculated the transfer factor, D , for all the dwellings where the pollution consists of a non-reactive gas cloud with constant concentration and three hours duration; the airing is presumed to take place 1 hour after the cloud has passed the dwelling.

$$D_{oi} = \frac{\int_0^4 N_i dt}{\int_0^3 N_o dt} = \frac{\int N_i dt}{3N_o} \quad 3.4.3.$$

The result is plotted in Fig. 3.4. as a function of the air-exchange rate for the dwelling in its entirety, n_k , that is, with open inner doors, corrected for wind speed and temperature differences. (see eq. 3.9.7.)

In this case, D can be found for the complete house from the following expression:

$$D = 1 - \frac{e^{-n_k}}{3n_k} (1 - e^{-3n_k}) \quad 3.4.4.$$

This curve is plotted in Fig. 3.4.

3.5. Model for depositing aerosols

When setting up models for the indoor particle concentration it is not permissible to neglect deposition and filtering.

If we look again at a three-room model we can construct the following expression for the changes of the concentration N_1 in room 1.

$$\frac{dN_1}{dt} = \alpha_{01} \cdot b_{01} \cdot N_0 + \alpha_{21} \cdot b_{21} \cdot N_2 + \alpha_{31} \cdot b_{31} \cdot N_3 + b_{11} \cdot N_1 - d_1 \cdot N_1 \quad 3.5$$

where α_{ij} is the transmission factor through the boundary. It is the part of the pollution contained in the air before passing a boundary that will be transmitted through the boundary between rooms i and j ; α_{0j} is the transmission factor from outside to room j ; and d_j is the part of the pollution contained in a unit volume in room j that is deposited on the surfaces per hour in room j .

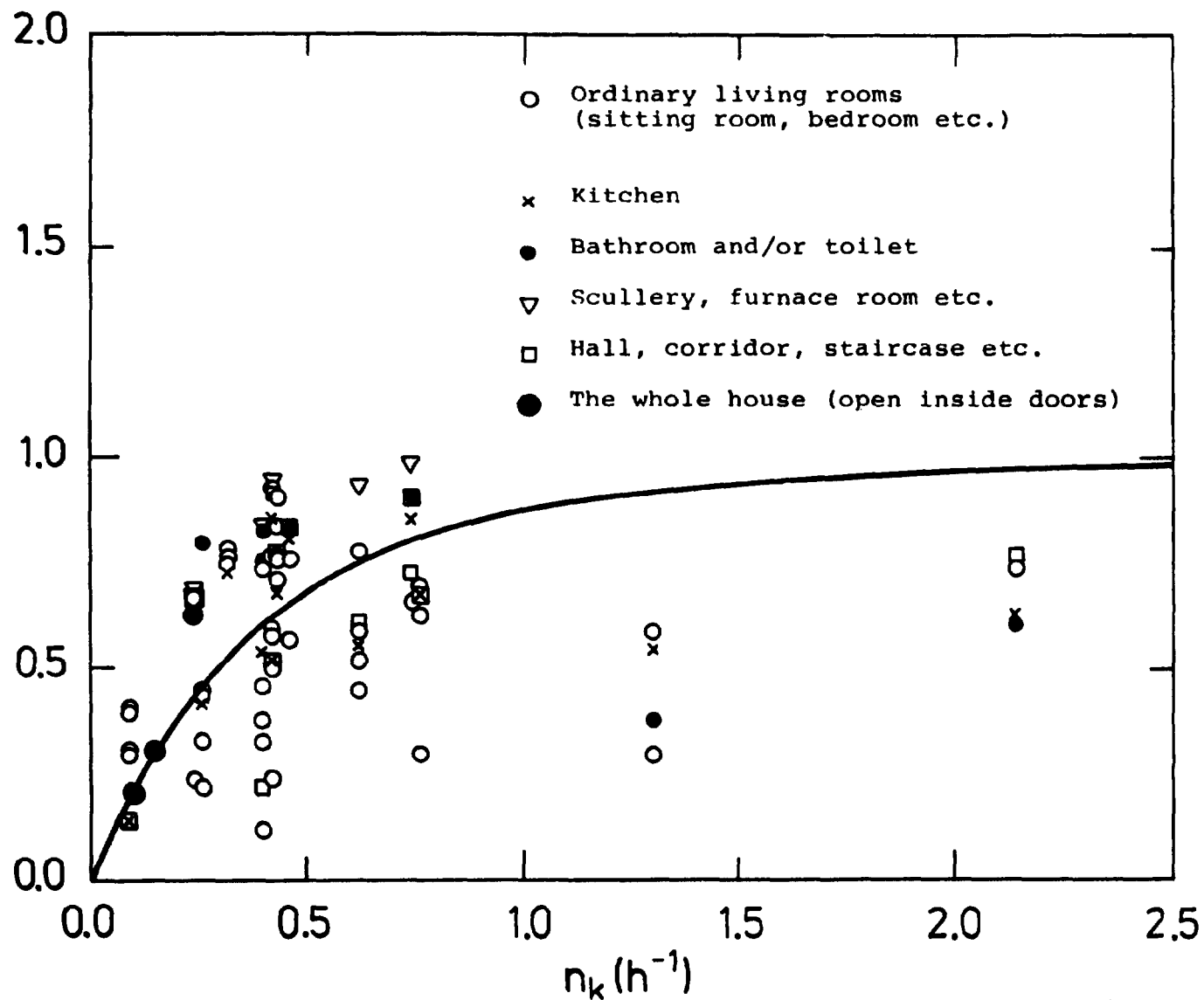

Fig. 3.4. The transmission factor, D , for a non-reactive gas by airing for 1 hour after cloud passage, as function of n_k , the corrected air exchange for the whole residence. Cloud passage time are 3 hours.

The first term on the right-hand side represents the pollution coming through the boundaries between the outside and room 1; the second and third term represents the pollution passing through the boundaries to neighbouring rooms; the fourth term represents the pollution disappearing from room 1 through the boundaries (b_{11} is negative); and the last term represents deposition on surfaces in the room.

Similar equations can be constructed for the concentration change in the other rooms.

3.6. Tracers used in measurements on non-reactive particles

Beryllium-7 was used as a tracer in these measurements. This isotope is created only by cosmic radiation, mainly in the stratosphere, so that its concentration inside buildings can be considered as originating from the outside.

3.7. Particles concentration measurements

The exposure integral is determined by allowing part of the contaminated air to pass through a high efficiency glass fiber filter and then measuring the amount of the tracer trapped in the filter and the volume of the air passing through it.

As the concentration of ^7Be in the air is very small it is necessary to extend the collection to about two weeks to have a sufficient amount of ^7Be collected on the filter. This is because the air suction velocity cannot be raised to high values. An indoor high air suction speed will result in a depletion of the indoor concentration; the compensation for the influence of measuring equipment will then be great resulting in a large uncertainty in the measured result.

The air sucking speed that is chosen must therefore take into consideration a reasonable uncertainty in the measurements

and the demand for a reasonable correction of the influence of the measuring equipment.

The amount of ⁷Be collected on the filter is determined by measuring the filter in a Ge(Li) detector.

3.8. Model change because of the influence of the measuring method

The method used for finding the time-integrated concentration of ⁷Be-particles results in a depletion of the indoor concentration. It is therefore necessary to construct a model that can correct for this depletion.

When the measuring system is operating an expression for the change in the concentration indoor in room No. 1 could be given as

$$\frac{dN_1^m}{dt} = \alpha_{01} \cdot b_{01} \cdot N_0 + \alpha_{21} \cdot N_2^m + \alpha_{31} \cdot b_{31} \cdot N_3^m + b_{11} \cdot N_1^m - d_1 \cdot N_1^m - S_1 \cdot N_1^m \quad 3.8$$

where the indices m indicate the measuring situation, and the last term in the expression represents the amount of pollution removed by the filter.

3.9. The model used in the measuring situation

During the long measuring period we consider the conditions to be nearly stable; this implies that the concentration is changing slowly.

$$\frac{dN_i^m}{dt} \quad \text{and} \quad \frac{dN_i}{dt} \quad \text{is therefore nearly equal to 0.}$$

The two expressions (3.5) and (3.8) can then be rewritten as

$$\alpha_{01} \cdot b_{01} \cdot N_0 + \alpha_{21} \cdot b_{21} \cdot N_2 + \alpha_{31} \cdot N_3 + b_{11} \cdot N_1 - d_1 \cdot N_1 = 0$$

3.9.1.

$$\alpha_{01} \cdot b_{01} \cdot N_0 + \alpha_{21} \cdot b_{21} \cdot N_2^m + \alpha_{31} \cdot N_3^m + b_{11} \cdot N_1^m - (d+S)N_1^m = 0$$

On subtracting the two equations and substituting ΔN_1 for $(N_1 - N_1^m)$, ΔN_2 for $(N_1 - N_2^m)$, and so on, the following equation is found:

$$(b_{11} - d_1) \Delta N + \alpha_{21} \cdot b_{21} \cdot \Delta N_2 + \alpha_{31} \cdot b_{31} \cdot \Delta N_3 = -S_1 \cdot N_1^m \quad 3.9.2.$$

Inserting into the equation (3.9.2) $N_1^m = N_o \cdot D_{o1}^m(E)$, where $D_{o1}^m(E)$ is the transfer factor for the exposure integral from outside to room 1 in the measuring situation, gives

$$(b_{11} - d_1) \cdot \Delta N_1 + \alpha_{21} \cdot b_{21} \cdot \Delta N_2 + \alpha_{31} \cdot b_{31} \cdot N_3 = -S_1 \cdot N_o \cdot D_{o1}^m(E) \quad 3.9.3$$

The transfer factor we want to find is, however, D_{oi} in the situation with no measuring equipment depleting the indoor concentration. It is

$$D_{oi} = \frac{\int N_i dt}{\int N_o dt} \quad 3.9.4.$$

D_{oi} can also be written as

$$\frac{\int (N_1^m + \Delta N_i) dt}{\int N_o dt} = D_{oi}^m + \frac{\int \Delta N_i dt}{\int N_o dt} = D_{oi}^m + \Delta D_{oi} \quad 3.9.5.$$

$$\text{where } \Delta D_{oi} = \frac{\int \Delta N_i dt}{\int N_o dt}$$

Integration of the equation over the measuring period gives

$$(b_{11}-d_1)\int \Delta N_1 dt + \alpha_{21} \cdot b_{21} \int \Delta N_2 dt + \alpha_{31} \cdot b_{31} \int \Delta N_3 dt = -S_1 D_{O1}^m \int N_0 dt$$

Dividing the equation by $\int N_0 dt$, inserting

$$\Delta D_{O1} = \frac{\int \Delta N_1 dt}{\int N_0 dt},$$

and expanding to n rooms gives the following system of equations:

$$(b_{11}-d_1) \Delta D_{O1} + \alpha_{21} \cdot b_{21} \Delta D_{O1} \dots + \alpha_{n1} \cdot b_{n1} \Delta D_{On} = -S_1 \cdot D_{O1}^m$$

$$\alpha_{12} \cdot b_{12} \Delta D_{O1} + (b_{22}-d_2) \Delta D_{O2} \dots + \alpha_{n2} \cdot b_{n2} \Delta D_{On} = -S_2 \cdot D_{O2}^m$$

.
. .
. .
. .
. .
. .
. .
. .
. .

3.9.6.

$$\alpha_{1n} \cdot b_{1n} \Delta D_{O1} + \alpha_{2n} \cdot b_{2n} \Delta D_{O2} \dots (b_{nn}-d_n) \Delta D_{On} = -S_n \cdot D_{On}^m$$

Where b_{ij} , is known from the measurement of the transport coefficients, and S_i , is found from the air suction velocity and the filtering efficiency. Because of the low deposition velocity indoors d_i can be set equal to 0. When $D_{O_i}^m$ is measured ΔD_{O_i} and thereby D_{O_i} can be determined if the transmission factors α_{ij} are known.

α_{ij} could be found from a series of measurements equal to those made in order to find the transport coefficient for non reactive gases using a particulate tracer.

This measurement has not been carried out. Instead we have found the transfer factor in two different cases, first for $\alpha_{ij}=0$ and then for $\alpha_{ij}=1$. The difference between the two sets of values is so small that the mean values are considered to represent the correct ones rather well.

The main results of the protection factor P is given for all of the 83 measured rooms in the 17 dwellings. The protection factor, P , is given as $(1/2(D_{oi}^{\min}+D_{oi}^{\max}))^{-1}$. D_{oi}^{\min} are the corrected values where $\alpha_{ij}=0$, and D_{oi}^{\max} are the corrected values where $\alpha_{ij}=1$. (Fig. 3.9.1., Fig. 3.9.2., and Fig. 3.9.3.)

In these figures the protection factor is given as a function of the corrected air-exchange velocity for the dwelling in its entirety n_k . n_k is a convenient parameter for characterising the tightness of the dwelling. This parameter has been measured by Denmark's Technological Institute (Collet et al. 1976) on a representative section of Danish dwellings, 53 houses and 28 flats, whereby a mean value of 0.63 h^{-1} for n_k was found.

The mean value of n_k for the dwellings in this investigation was 0.4 h^{-1} , and because of the better standard of tightness today the measured dwellings seems to represent the Danish dwellings fairly well.

In the report from the Technological Institute a formula for n_k is given by

$$n_k = n \cdot 3.23(1+0.05\Delta t+0.30v)^{-1} , \quad 3.9.7.$$

where Δt is the temperature difference in $^{\circ}\text{C}$ between the outside and inside and v is the wind speed in m/s in 10 m height. n_k is the average n over the year corresponding to $\Delta t = 17^{\circ}\text{C}$ and $v=4.6 \text{ m/s}$.

The mean value of the protection factor for residence rooms (living rooms, bedrooms, etc.) is about 3, and for the rest of the rooms it is about 2.5.

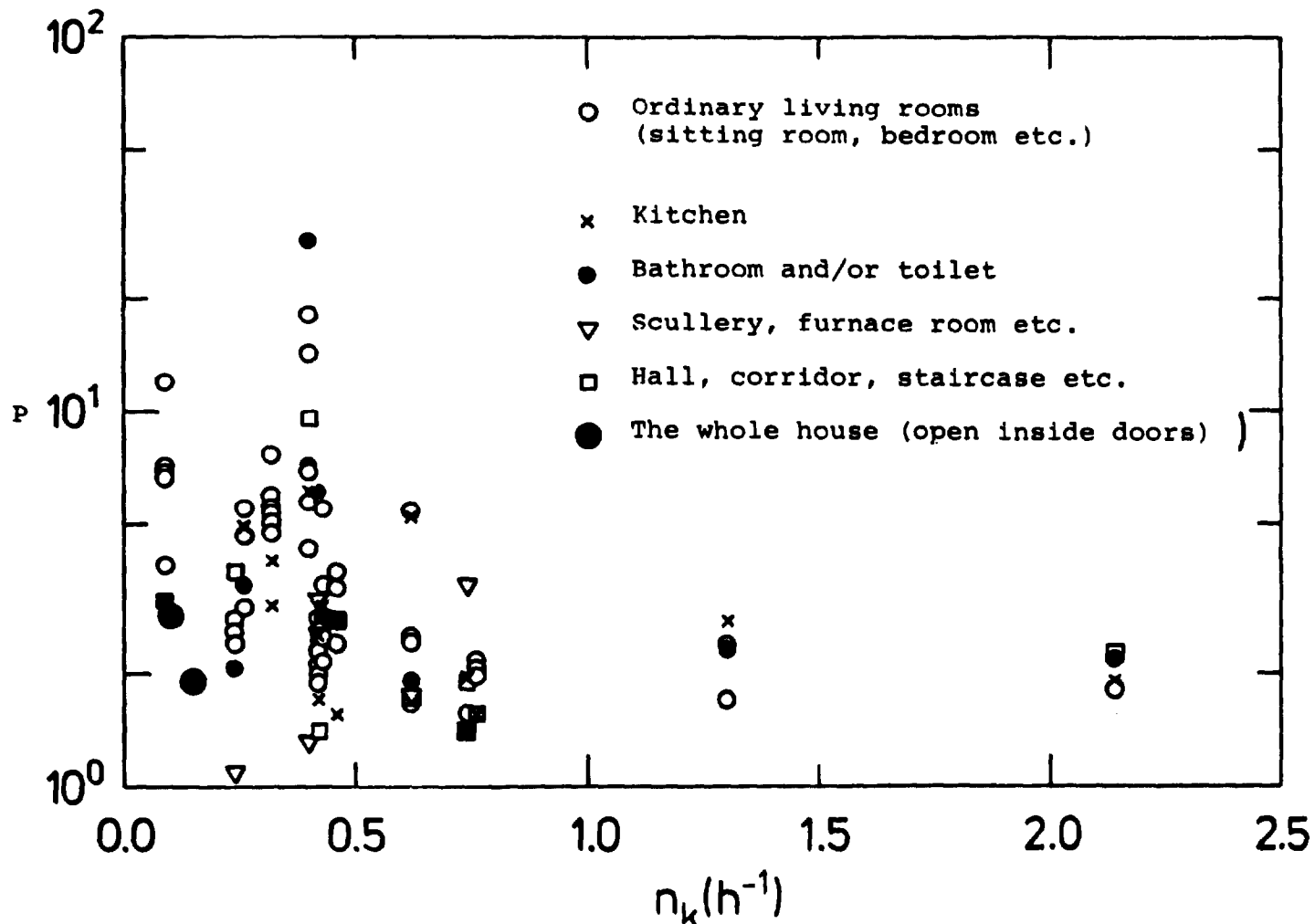

Fig. 3.9.1. The protection factor P , for non-reactive particles as function of n_k , the corrected air exchange for the whole residence. All rooms of the residence.

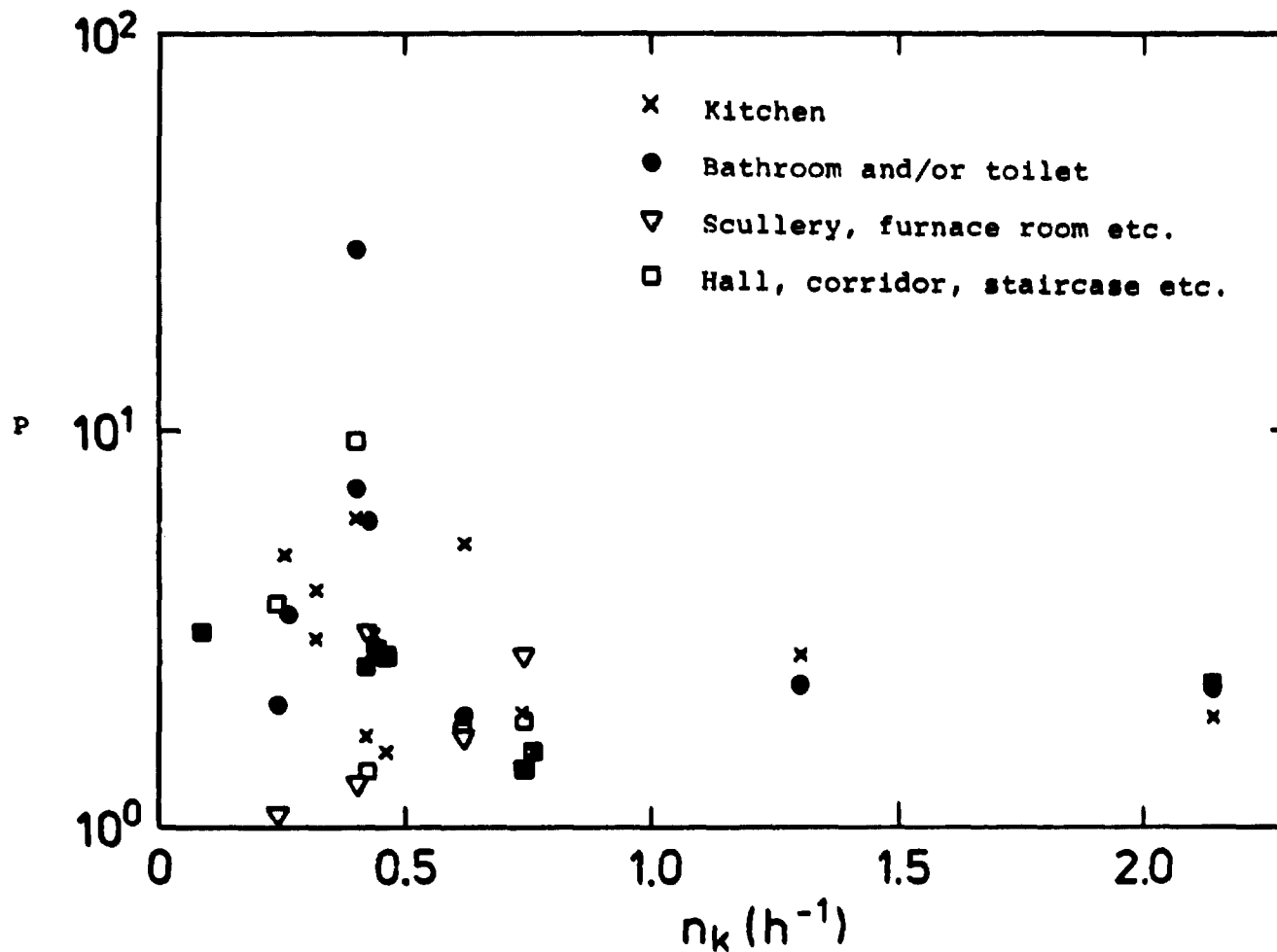

Fig.3.9.3. The protection factor P , for non-reactive particles as function of n_k , the corrected air exchange for the whole residence. Extra rooms.

Figure (3.9.4.), (3.9.5.), and (3.9.6.) show examples of the combined effect of filtering and airing for a cloud of 3 hours duration when airing takes place 1 hour following cloud passage.

The mean value for residence rooms is about 6.5 and for other rooms about 3.5.

3.10. Mechanical cleaning of polluted air

The cleaning effect performed by a vacuum cleaner operated in a room can be found if D_{oi} is known by solving the equations (3.9.6.) setting $d_i=0$ and the right-hand side to 0 except for the one equality that expresses the condition in the room where the vacuum cleaner is operating; then $\Delta D_{oi}^{(max)}$ and $\Delta D_{oi}^{(min)}$ are found by setting $\alpha_{ij}=0$ respectively = 1, and then subtracting the ΔD_{oi} from D_{oi} , finding respectively $D_{oi}^s(min)$ and $D_{oi}^s(max)$, where the indices s stands for suction.

For a vacuum cleaner having an air suction speed of 60 m³/h and a filtering efficiency of 0.833 and $\alpha_{ij}=0$ corresponding to no filtration through the walls, the calculation has been made resulting in the curve shown on Fig. 3.10., where the protection factor is given as a function of room volume and ventilation rate.

A vacuum cleaner Elektrolux model 318Z has been investigated. It had a suction speed of 60 m³/h and an air filter efficiency of 0.97 for ⁷Be particles.

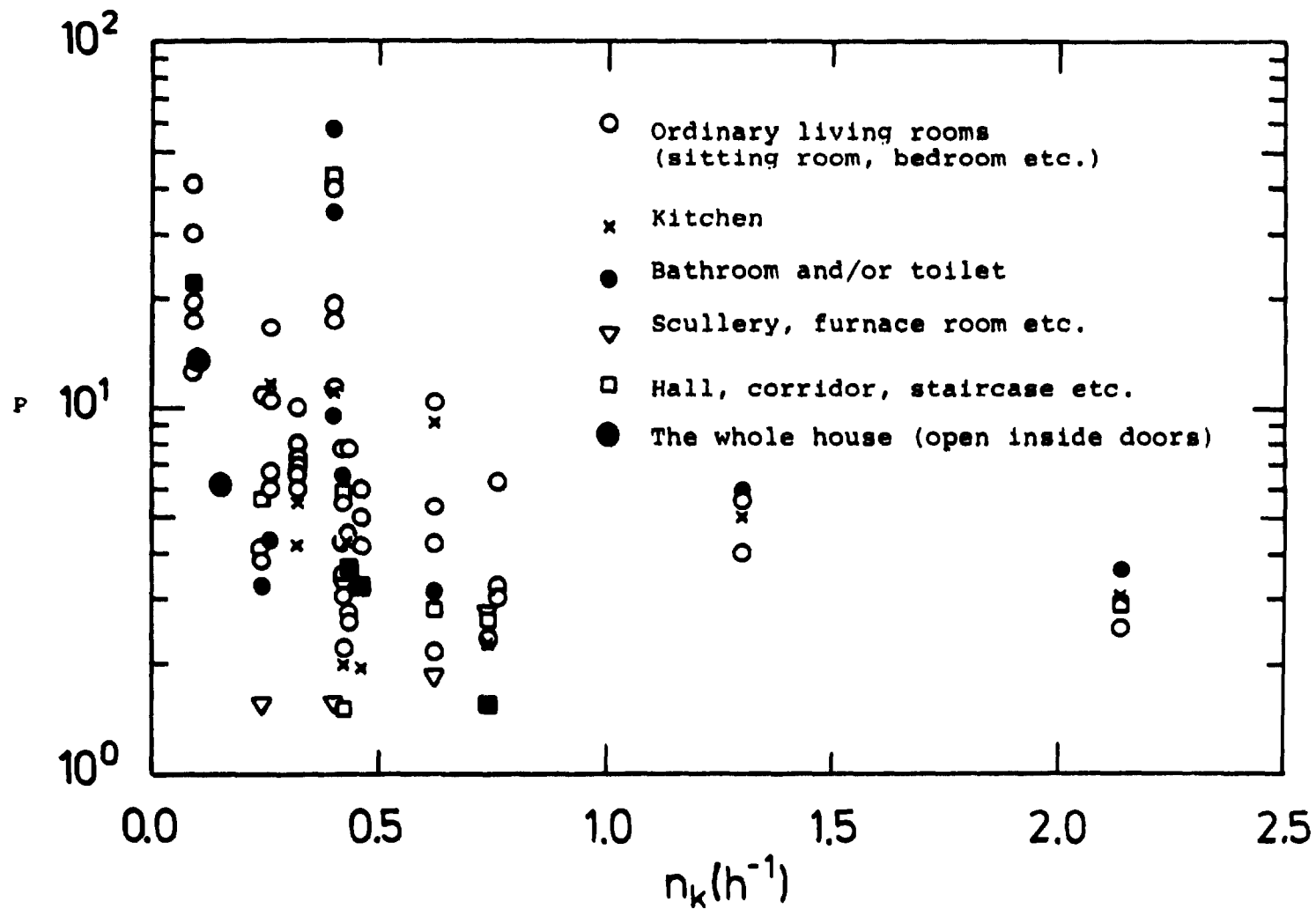

Fig. 3.9.4. The protection factor P , for non-reactive particles by airing for one hour after cloud passage as function of n_k , the corrected air exchange for the whole residence. Cloud passage is three hours.

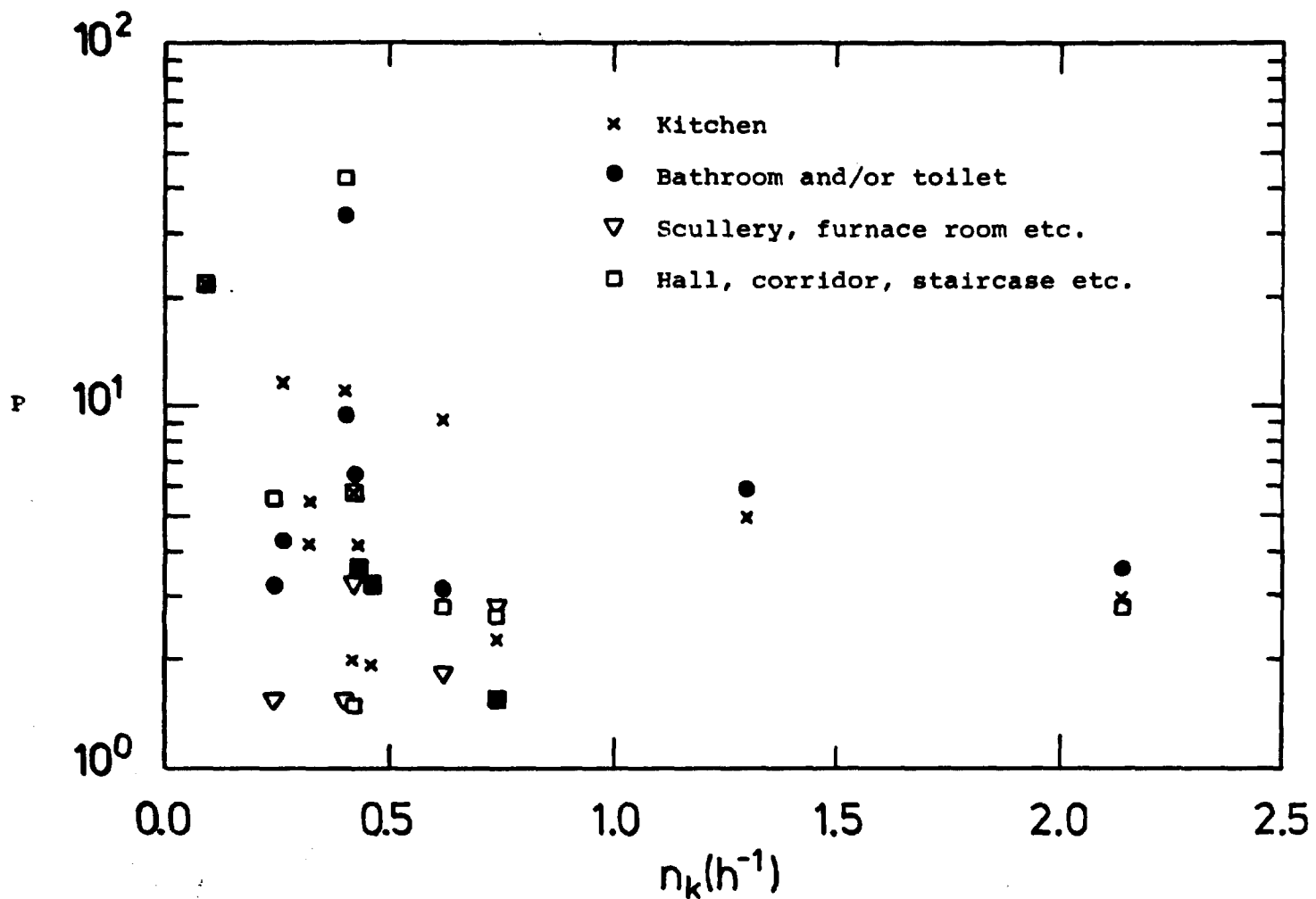
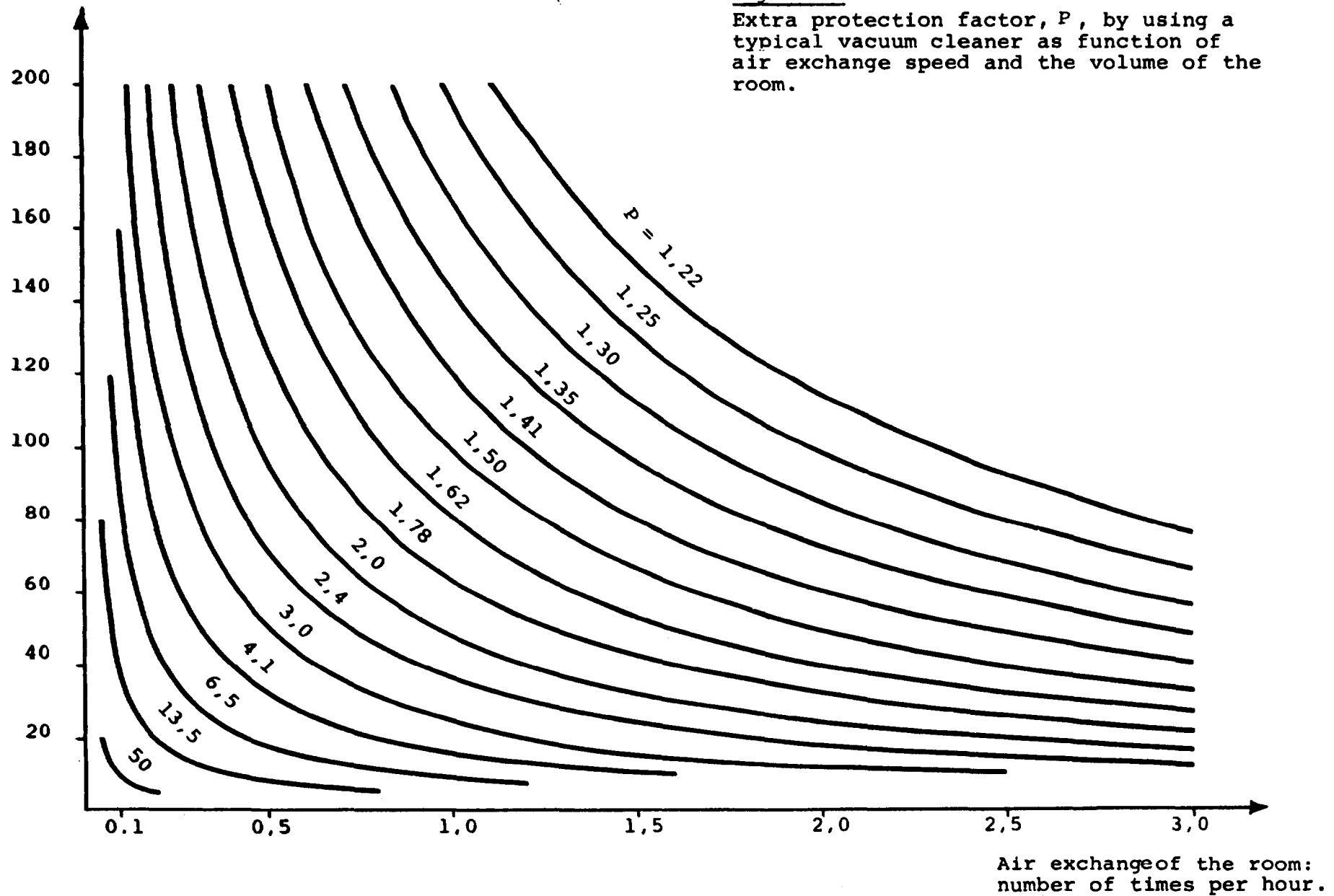

Fig. 3.9.6. The protection factor P , for non-reactive particles by airing for 1 hour after cloud passage, as function of n_k , the corrected air exchange for the whole residence. Cloud passage are 3 hours.

Volume of the room: m^3

Fig. 3.10.

Extra protection factor, P , by using a typical vacuum cleaner as function of air exchange speed and the volume of the room.



4. CONCLUSION

Our measurements on indoor/outdoor concentration has shown that staying indoor in an average living room (approx. 50m³) with closed windows and doors during a pollution episode will provide a protection for inhalation in comparison to outside as shown in Table 4.

Table 4

Indoor protection factor *)P for an average living room

	no airing	airing** 1 hour after cloud passage	use of vacuum cleaner no airing	use of** vacuum cleaner and airing 1 hour after cloud passage
non- reactive gases	1	2	1	2
non- reactive particles	3	6	9	12

*)
$$P = \frac{\text{the outdoor time-integrated air concentration}}{\text{the indoor time-integrated air concentration}}$$

***) Constant cloud concentration, duration 3 hours

A literatur study has shown that the protection factor for reactive gases is higher than for non-reactive gases, so that using the protection factor for particles in a model will be a conservative measure.

REFERENCES

- ALZONA, J., COHEN, B.L., RUDOLPH, H., JOW, H.N., and FROHLIGER J.O. (1979). Indoor-Outdoor Relationships for Airborne Particulate Matter of Outdoor Origin. *Atmospheric Environment* 13, 55.
- BECHER, P.E., GJØRUP, H.L., MEIDE, A., MICHEELSEN, B. THYKIER-NIELSEN, S., PEJTERSEN, V.S., and PETERSEN, T. (1981). Calculation of Dose Consequences of a Hypothetical Large Accident at a Nuclear Power Reactor. Risø-M-2299.
- BIERSTEKER, K., de GRAFF, H., and NASS, C.A.G. (1965). Indoor Air Pollution in Rotterdam Homes, *J. Air. Wat. Poll.* 9, 343-350.
- COLLET, P.E. et al. (1976). The Air-exchange Rate of Dwellings, (in Danish) Teknologisk Institut, Byggeteknik.
- GJØRUP, H.L., and ROED, J. (1980). A Note on the Relationship Between Outdoor and Indoor Exposure Integrals for Air Pollution of Outdoor Origin. Risø-M-2234.
- MEGAW, W.J. (1961). The Penetration of Iodine into Buildings. Atomic Energy Research Establishment, Harwell, AERE-R-3827.
- ROED, J., GJØRUP, H.L., PRIP, H. (1985). Reduction in Inhalation Dose by Staying Indoors, (in Danish). Risø-M-2484, (in print).
- YOCOM, J.E., CLINK, W.L., and COTE, W.A. (1971). Indoor/Outdoor Air Quality Relationships. *J. Air. Poll. Contr. Ass.* 21, 251 ff.

Risø - M - 2476

<p>Title and author(s)</p> <p>RELATIONSHIPS IN INDOOR/OUTDOOR AIR POLLUTION</p> <p>Jørn Roed</p>	<p>Date January 1985</p> <p>Department or group Health Physics</p> <p>Group's own registration number(s)</p>
<p>pages + tables + illustrations</p>	
<p>Abstract</p> <p><u>Abstract.</u> Beryllium-7 and sulphurhexaflourid has been used as tracers in measurements designed to enable an estimate of the ratio of the outdoor to indoor time-integrated concentration for aerosols and non-reactive gasses of outdoor origin with a special reference to the reduction in inhalation dose that can be achieved by staying indoors during a pollution episode, especially a reactor accident.</p> <p>The effect of operating a vacuum cleaner during the pollution episode and airing shortly after is also investigated.</p> <p>Earlier relevant literature is reviewed and shows good agreement with the results in this study. Protection factor from 1-12 has been found.</p> <p>Available on request from Risø Library, Risø National Laboratory (Risø Bibliotek), Forsøgsanlæg Risø), DK-4000 Roskilde, Denmark Telephone: (03) 37 12 12, ext. 2262. Telex: 43116</p>	<p>Copies to</p>