



Voltage Balancing for Bipolar DC Distribution Grids: A Power Flow based Binary Integer Multi-Objective Optimization Approach

Chew, Benjamin Si Hao; Xu, Yan; Wu, Qiuwei

Published in:
IEEE Transactions on Power Systems

Link to article, DOI:
[10.1109/TPWRS.2018.2866817](https://doi.org/10.1109/TPWRS.2018.2866817)

Publication date:
2018

Document Version
Peer reviewed version

[Link back to DTU Orbit](#)

Citation (APA):
Chew, B. S. H., Xu, Y., & Wu, Q. (2018). Voltage Balancing for Bipolar DC Distribution Grids: A Power Flow based Binary Integer Multi-Objective Optimization Approach. *IEEE Transactions on Power Systems*, 34(1), 28 - 39. <https://doi.org/10.1109/TPWRS.2018.2866817>

General rights

Copyright and moral rights for the publications made accessible in the public portal are retained by the authors and/or other copyright owners and it is a condition of accessing publications that users recognise and abide by the legal requirements associated with these rights.

- Users may download and print one copy of any publication from the public portal for the purpose of private study or research.
- You may not further distribute the material or use it for any profit-making activity or commercial gain
- You may freely distribute the URL identifying the publication in the public portal

If you believe that this document breaches copyright please contact us providing details, and we will remove access to the work immediately and investigate your claim.

Voltage Balancing for Bipolar DC Distribution Grids: A Power Flow based Binary Integer Multi-Objective Optimization Approach

Benjamin Si Hao Chew, *Student Member, IEEE*, Yan Xu, *Member, IEEE*, and Qiuwei Wu, *Senior Member, IEEE*

Abstract— The re-emergence of 2-phase bipolar DC distribution network, which utilizes the neutral wire for efficient distribution, has spurred research interest in recent years. In practice, system efficiency (power loss) and voltage unbalance are major concerns for the planning and design of the 2-phase DC bipolar network. While most of the existing methodologies are power electronics solutions, there are very few works on resolving the problem from the power system perspective. This paper proposes a model based optimization method by firstly formulating the power flow model for 2-phase DC bipolar network using the single line modeling technique and nodal analysis. Secondly, a binary integer load distribution model is proposed to consider the redistribution of unipolar loads across the two unipolar distribution poles. Together with the power flow model, the system power loss and system voltage unbalance indices are formulated as a binary integer quadratic model. Thirdly, a multi-objective optimization model is formulated and solved using the weighted sum approach. The proposed method is applied to a DC LED lighting system design which considers both voltage unbalance and power loss. Using a 15 bus single source and a 33 bus multi-source network as case studies, the developed power flow model is validated with very high accuracy. Compared to existing iterative methods, the proposed model-based approach is able to significantly improve the voltage balancing across the distribution system.

Index Terms— 2-phase DC network modeling, binary integer, DC bipolar distribution system, DC LED lighting system, optimal load distribution, voltage unbalance

The work of Benjamin S. H. Chew is supported by Nanyang Technological University Research Scholarship. Y. Xu's work is supported by the Nanyang Assistant Professorship from Nanyang Technological University, Singapore. The work in this paper is partially funded by the Republic of Singapore's National Research Foundation through a grant to the Berkeley Education Alliance for Research in Singapore (BEARS) for the Singapore-Berkeley Building Efficiency and Sustainability in the Tropics (SinBerBEST) Program, and also supported in part by Singapore Ministry of Education under an AcRF Tier 1 project.

S. H. Chew and Y. Xu are with the School of Electrical and Electronic Engineering, Nanyang Technological University, Singapore 639798. (e-mail: SCHEW007@e.ntu.edu.sg; eeyanxu@gmail.com)

Q. Wu is with the Center for Electric Power and Energy, Department of Electrical Engineering, Technical University of Denmark, 2800 Kgs. Lyngby, Denmark and Harvard China Project, School of Engineering and Applied Sciences, Harvard University, 29 Oxford Street, Cambridge, MA 02138, USA (e-mail: qw@elektro.dtu.dk, qiuwu@seas.harvard.edu).

I. INTRODUCTION

A. Background and Literature Review

IN the last decades, the centralized AC power system was an effective means for electricity generation and delivery. This is because the AC voltage can be easily stepped up using a transformer and AC power can be transported over long distances efficiently. However, as power electronics technology advances over the years and together with the rise in use of DC distributed energy resources (DERs) such as solar photovoltaic, fuel cells and battery energy storage devices, which are inherently DC energy sources, DC systems re-emerge in distribution power networks.

A DC distribution system can be constructed as a unipolar or bipolar system. A unipolar LVDC distribution system has only one voltage level with two wires while a bipolar LVDC distribution system is a 2-phase system with three wires [1]. The bipolar architecture is an emerging energy efficient DC system architecture that uses the neutral wire for power distribution purposes [2]. It allows for twice the power distribution with half the additional cable installation cost. Furthermore, a bipolar architecture has a lower line-to-ground safety risk because the interfacing neutral point is grounded and this halves the maximum DC line voltage with respect to ground [3]. Other advantages of the 2-phase DC bipolar architecture include the flexible selection of multiple DC voltage level for efficient operation [4] and higher system reliability. In the case of a 2-pole fault, the loads can be reconfigured to be powered by the non-faulted operating pole [5].

However, the DC power systems also suffer from several deficiencies such as 1) the power imbalance among power sources and loads, 2) the voltage flickers, 3) the unstable bus voltage oscillation due to constant power loads, and 4) the bus voltage fluctuation due to intermittent renewable power generation [6].

The issue of power imbalance among multiple DG sources, and between sources and loads on DC power system has been reported in [7] and [8]. The accuracy of the power flow results is reported to be higher when the power flow equation is considered together with the droop control and virtual impedance [9]. The use of distributed DC electric spring for demand management of non-critical loads is reported in [6] as one possible solution to voltage fluctuations and power balancing. The above works examine the issue of power balance from the

control and power electronics perspective without power flow model of the DC network.

As a basic steady-state analysis tool, power flow analysis is essential to get the overall view of the system in the design and operation of DC power systems so that network optimization can be carried out in the planning stage [10]. Conventionally, power flow is modeled by nodal voltage analysis of the P and V buses in DC system [11]. However, due to distinct features between power transmission and distribution systems, conventional methods for power flow analysis are becoming no longer suitable at distribution level [9]. Specific to distribution systems in built environment which have multiple slack buses, one limitation is the presence of voltage-only measurements due to direct integration of DC energy sources [12]. Another technological advance is such that the DC network may experience grid islanded operational mode due to the direct integration of DC energy sources [13]. As a result, with the above distribution network characteristics, the power flow model has to be robust to account for 1) voltage-only measurement of the DC energy sources, 2) grid islanded operation and the effects of connection and disconnection of DC energy sources.

Besides, most of the existing works on DC distribution modeling is based on the unipolar DC architecture [14], [15]. There are limited references for bipolar DC architecture [2]. Reference [16] models the bipolar DC architecture at transmission level using a state space linear algebraic approach with a focus on dynamic analysis. This work is in [17] for fault analysis using the symmetrical method proposed in [18]. References [12] and [19] report that single line modeling technique is not suitable to model the bipolar DC architecture directly. Reference [12] decomposes the bipolar DC architecture and models the network using a backward-forward iterative methodology, and has successfully been validated against the nodal voltages of an actual mockup DC LED lighting system. Reference [19] decomposes the architecture into its sources and physical network layer and minimizes the locational marginal price together with the current characteristics in the neutral cable. Yet still, there are very limited works in modeling the bipolar DC architecture at distribution level with a focus on steady-state analysis.

The 2-phase bipolar DC architecture is energy efficient due to the opposite directional flow of current in the positive and negative poles distribution system in the neutral cable [18]. This results in a smaller net current flow in the neutral cable. However, in the case of asymmetrical loading in both positive and negative distribution poles, the voltage drop across the neutral cable is not constant and this results in voltage unbalance across the 2-phase DC bipolar distribution network. While existing literature, such as the distributed DC electric spring, focuses on regulating the voltage drop [6], it is not desirable for cases looking at minimal hardware investments such as the DC LED lighting system in [20], [21].

Voltage unbalance is a power quality index [22] and it affects the efficiency of the system design during power system design and planning stage [23]. Also, voltage unbalance is caused when the voltage drop of the positive rail and negative

rail are not equal [17]. It results in current flowing in the neutral grounded conductor which is not allowed because it causes corrosion [1].

Existing methods for managing voltage unbalance have been developed from the perspective of the control aspect of power electronics which is similar to the mitigation in AC systems using active filters. However, the power-electronics based solution requires additional hardware investments and it may reduce the load efficiency which reduces the overall system efficiency. As such, for cost-effective reasons, to manage voltage unbalance, the perspective of power system planning and operation should be taken. Existing methodologies in the literature converge to the following:

- 1) Reduction in the net current in the neutral distribution cable due to the distribution of the unipolar DC loads from the: 1) power electronics perspective [24] and [25] or 2) power system perspective using backward iterative method [5].
- 2) Use of voltage based measurement such as: 1) Redistributing the power consumption of the loads using energy storage systems when the localized voltage is out of the voltage balance range [26]; 2) Adjusting the interfacing DC voltage when the localized voltage is out of the voltage balance range [27]; 3) Distributing the loads by considering the non-negligible voltage drop based on voltage measurements using backwards iterative method [12].
- 3) Use of locational marginal price to reduce congestions between the two phase distribution iteratively [19].

B. Problem Descriptions

In the review of existing literature, there are a few limitations towards the voltage balancing methodologies.

- 1) The use of net neutral current for analysis does not take into account of the effects of voltage drop due to the distribution of bipolar DC loads. This is analogous to voltage unbalance between single and 3-phase loads in AC networks [28].
- 2) The existing methodologies mainly utilize iterative method such as the backward-forward sweep for analysis. The iterative method is designed for simple radial distribution systems and is popular due to its intuitive solution procedure [29]. However, one main disadvantage of iterative methods is that the relationships among components are built by a direct observation. If the network is large, the preparation can be difficult, as can be observed in [9], and prone to errors or when the observed network is non-observable such that the numbering of the “parent node” and “child node” arrangement is not easily constructed, iterative methods are not applicable [30]. One example of non-observable network architecture is the ladder architecture when power sources are integrated at the opposite ends of a radial distribution [13].

Furthermore, the existing literature models the load as a single aggregated entity of different types [31]. At distribution level, a few characteristics of the distribution system are observed as follows: 1) The network resistance to inductance ratio is high [9] such that it is highly resistive and the voltage

drop can be large [12] and 2) The loads are distributed along the same distribution line [12]. Consequently, due to the distributed arrangement, reference [32] proposed an analytical approximated approach to model the power losses in a linear distribution system. However, there is still a gap towards the modeling of power losses in a bipolar DC distribution system.

Therefore, the existing methodologies may not be suitable for larger scale non-observable highly resistive distribution network with certain distribution network characteristics such as voltage-only measurement of the DC energy sources, grid islanded operation and the effects of connection and disconnection of DC energy sources. Furthermore, there are limited research works in modeling the bipolar DC architecture at distribution level with a focus towards steady state analysis.

C. Contribution of This Paper

The major contributions in this paper are summarized as follows:

- 1) A power flow model of the 2-phase bipolar DC network is developed and validated. The methodology decomposes conventional nodal analysis equations into the load and source voltage components. The highly resistive bipolar DC grid is then decomposed and nodal analysis is performed for each distribution line. The power flow model is developed considering different types of loads such as positive and negative rail unipolar and bipolar DC load. The mathematical model results are then compared with the simulated results using Matlab Simulink. The developed power flow model is highly accurate with an error of the order of magnitude of 10^{-5} as seen in the nodal voltages of the 15-bus radial network. Compared with the existing iterative methods, the proposed power flow method is able to model the nodal voltages with high accuracy of order of magnitude of 10^{-4} error without having to determine the parent and child nodes in a multiple DC power sources complex network using a 33-bus case study.
- 2) A binary integer load distribution model is developed to distribute the unipolar DC loads to either of the 2 distribution phases. The binary integer distribution model is used to formulate a binary integer quadratic function for minimizing system voltage unbalance or system power losses.
- 3) A binary integer quadratic weighted sum multi-objective optimization method is then developed to optimally determine the optimal distribution of the DC loads to either of the two phases for minimizing both system voltage unbalance and system power losses. Compared with existing iterative methods, the model-based optimized solution has a lower unbalance voltage index because the distribution of bipolar loads is considered and the voltage balancing takes into account at system level instead of nodal comparison.
- 4) The proposed power flow model and voltage balancing methodology are then extended to non-observable networks and tested on the larger 33-bus networks. The proposed model-based MOO method has successfully shown that the voltage across the 2-phase bipolar DC network is balanced and can be carried out with reasonably fast solu-

tion speed.

II. BASIC MODELING BIPOLAR DC NETWORK

The bipolar DC network studied in this paper has the following characteristics: 1) Both positive and negative rail power sources are integrated at every source node; 2) The bipolar and unipolar loads are unidirectional; 3) The network is highly resistive; 4) There are no additional interfacing power converters for voltage regulation purposes.

A. Power Flow Model

The labeling of the network nodes is divided into two components, mainly the source and load nodes. The nodes are indexed from '0' to 'n' to 'm'. The voltage node of the grid interfacing converter corresponds to the "slack" node. It is indexed as node '0' ($i = 0$). The corresponding 'n' number of nodes is the load nodes in running order with node '1' the closest to the interfacing converter. The remaining 'n + 1' to 'm' number of nodes is the remaining source nodes. The conventional conductance representation between node index i and j , g_{ij} , remains the same representation.

In a bipolar DC network, a node is created when a DC source is integrated or a DC load is distributed across either of the unipolar or the bipolar distribution pole. As a bipolar DC network consists of 3 distribution cables, the bipolar DC network is decomposed and nodal analysis is carried out for each of the distribution cables. As such, $G_{+/N/-(i,j)}$ represents the cable conductance of positive, neutral and negative pole cables between node i and j respectively. $V_{+/N/-(i)}$ represents the voltage node of positive, neutral and negative pole at node i while $I_{+/N/-(i)}$ represents the output current at node i , respectively. Using the convention of positive reference current direction as out of the system node, the positive pole load draws current from the positive pole node and returns via the neutral pole node, the negative pole load draws current from the neutral pole node and returns via the negative pole node and the bipolar load draws current from the positive pole node and returns via the negative pole node. $I_{p/n/b(i)}$ represents the positive, negative and bipolar pole distribution load current at network node i . Fig.1 shows the above mentioned descriptions of the nodal current and network voltage representations using a 2-node system as an example.

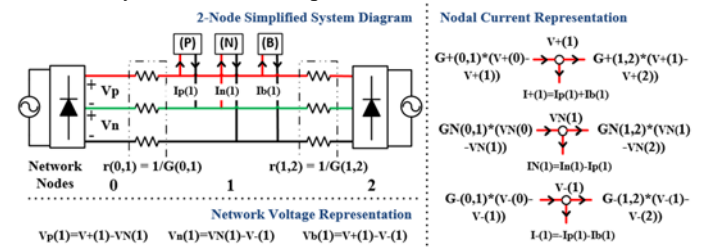

Fig. 1. a) A 2-node simplified system diagram example; b) Nodal current representation and; c) Network voltage representation

For the nodal analysis on each single line modeling, without the loss of generality, (1) to (3) are used to model the relationship between the bipolar and unipolar load currents in linear algebraic form with the 2-phase bipolar DC network.

$$\mathbf{I}_+ = \mathbf{I}_p + \mathbf{I}_b = \mathbf{G}_+ \mathbf{V}_+ \quad (1)$$

$$\mathbf{I}_N = \mathbf{I}_n - \mathbf{I}_p = \mathbf{G}_N \mathbf{V}_N \quad (2)$$

$$\mathbf{I}_- = -\mathbf{I}_n - \mathbf{I}_b = \mathbf{G}_- \mathbf{V}_- \quad (3)$$

where $\mathbf{I}_{p/n/b}$ and $\mathbf{V}_{p/n/b}$ represent the current and voltage vectors of positive, negative and bipolar load in the bipolar DC system, respectively. $\mathbf{I}_{+/N/-}$ and $\mathbf{V}_{+/N/-}$ represent the current and voltage vectors of the network nodes in the bipolar DC system, respectively. $\mathbf{G}_{+/N/-}$ represents the conductance matrix with the conventional representation in a positive, neutral and negative distribution cable, respectively.

As the measurement of a positive, negative rail and bipolar rail voltage is taken as the difference between the positive and neutral pole, neutral and negative pole, and positive and negative pole node respectively. Taking the vector difference of (1) and (2), (2) and (3) and (1) and (3), the generic DC voltage vector for positive, negative and bipolar pole distribution can be modeled as $\mathbf{V}_{p/n/b}$. The distribution of bipolar loads is a form of splitting single phase voltages which are 180 degrees out of phase with reference to the neutral line and no current flows in the neutral cable. Furthermore, as the electrical network is usually multicore, the cable conductance for all the three cables between node i and j is the same, i.e., $\mathbf{G} = \mathbf{G}_{+/N/-}$. As such, the power flow model for a 2-phase bipolar DC network, analogous to power flow for AC networks, can be expressed as (4).

$$\begin{bmatrix} 2\mathbf{I} & -\mathbf{I} & \mathbf{I} \\ -\mathbf{I} & 2\mathbf{I} & \mathbf{I} \\ \mathbf{I} & \mathbf{I} & 2\mathbf{I} \end{bmatrix} \begin{bmatrix} \mathbf{I}_p \\ \mathbf{I}_n \\ \mathbf{I}_b \end{bmatrix} = \begin{bmatrix} \mathbf{G} & \mathbf{0} & \mathbf{0} \\ \mathbf{0} & \mathbf{G} & \mathbf{0} \\ \mathbf{0} & \mathbf{0} & \mathbf{G} \end{bmatrix} \begin{bmatrix} \mathbf{V}_p \\ \mathbf{V}_n \\ \mathbf{V}_b \end{bmatrix} \quad (4)$$

where \mathbf{I} is the identity matrix. $\mathbf{I}_{p/n/b}$ and $\mathbf{V}_{p/n/b}$ represent the current and voltage vectors of positive, negative and bipolar load in the bipolar DC system, respectively. \mathbf{G} represents the conductance matrix with the conventional representation.

Unique to DC power systems, direct integration of DC energy storage system is plausible and the network can be operated in grid islanded mode under certain situations [13]. Unlike transmission level, at the distribution level, in carrying out power flow analysis, the primary known parameter of DC power sources is its voltage value. The power output is unknown [11], [13]. Consequently, it is necessary to incorporate such phenomenon into (4). As such, the power flow model in (4) is decomposed to its load nodes and source nodes in (5) and (6) with the voltage measurement as the main parameter for the DC energy sources. The detailed description of decomposing (4) to (5) and (6) is provided in Appendix A.

$$\begin{bmatrix} 2\mathbf{I} & -\mathbf{I} & \mathbf{I} \\ -\mathbf{I} & 2\mathbf{I} & \mathbf{I} \\ \mathbf{I} & \mathbf{I} & 2\mathbf{I} \end{bmatrix} \begin{bmatrix} \mathbf{I}_p \\ \mathbf{I}_n \\ \mathbf{I}_b \end{bmatrix} = \begin{bmatrix} \mathbf{G}_L & \mathbf{0} & \mathbf{0} \\ \mathbf{0} & \mathbf{G}_L & \mathbf{0} \\ \mathbf{0} & \mathbf{0} & \mathbf{G}_L \end{bmatrix} \begin{bmatrix} \mathbf{V}_p \\ \mathbf{V}_n \\ \mathbf{V}_b \end{bmatrix} + \mathbf{F}(\mathbf{V}_s) \quad (5)$$

$$\mathbf{F}(\mathbf{V}_s) = \sum_{i=0, n+1}^m \begin{bmatrix} \mathbf{G}_{s,p,i} & \mathbf{0} & \mathbf{0} \\ \mathbf{0} & \mathbf{G}_{s,n,i} & \mathbf{0} \\ \mathbf{0} & \mathbf{0} & \mathbf{G}_{s,b,i} \end{bmatrix} \begin{bmatrix} \mathbf{V}_{s,p,i} \\ \mathbf{V}_{s,n,i} \\ \mathbf{V}_{s,b,i} \end{bmatrix} \quad (6)$$

where $[\mathbf{I}_p \ \mathbf{I}_n \ \mathbf{I}_b]_L^T$ and $[\mathbf{V}_p \ \mathbf{V}_n \ \mathbf{V}_b]_L^T$ represent the steady state load current model and network nodal voltage. \mathbf{I} represents the identity matrix. $[\mathbf{V}_{s,p,i} \ \mathbf{V}_{s,n,i} \ \mathbf{V}_{s,b,i}]^T$ represents the voltage level of the source node ' i ' where ' i ' = 0 or ' $n + 1$ ' to ' m '. $\mathbf{V}_{s,i}$ represents the pole type voltage source ' i '

vector where ' i ' = 0 or from ' $n + 1$ ' to ' m ' and ' j ' = p, n, b i.e. $\mathbf{V}_{s,p,0} = [V_{p,0} \ \dots \ V_{p,0}]^T$.

As DC sources are integrated at both the positive rail and negative rail, the source conductance matrix can be re-expressed as $\mathbf{G}_{s,l} = \mathbf{G}_{s,p,i} = \mathbf{G}_{s,n,i} = \mathbf{G}_{s,b,i}$. The load conductance matrix is represented as $\mathbf{G}_L = \mathbf{G}_1 - \sum_{i=0, n+1}^m \mathbf{G}_{s,i}$, with \mathbf{G}_1 represents the conventional representation of self-conductance and cross-conductance of each distribution cable excluding the sources and their network conductance, i.e. $g_{ij} = g_{ji}$ for $i \neq j$. $g_{ii} = -\sum_{j=1}^n g_{ij}$, for $1 < i < n$ and $1 < j < n$. The diagonals of the source conductance matrix $\mathbf{G}_{s,l}$, represents the cross-conductance of the distribution cable between the source and the load nodes, i.e. $g_{ik} = g_{ki} = 0$ for $i \neq k$, with $1 < k < n$, i representing the load node and l the source node and $g_{ii} = g_{il}$, with $1 < i < n$ and $l = 0$ or $n + 1 < l < m$.

B. Load Model

DC loads are usually integrated with power electronics converters which behave like a constant power load [33]. While there are different load models in the literature [34], their behavior is complex in nature and they do not have reactive power, this paper uses the polynomial active power ZIP load model to model the DC loads [35]. The load model can be defined as (7).

$$P = P_0(a_0 + a_1V + a_2V^2) \quad (7)$$

where P and V represent the input power and voltage of the load and P_0 , a_0 , a_1 and a_2 are the coefficients the parameters of the model which depends on the actual load composition and load study.

In this paper, the load model is a voltage-dependent load model as described in [36]. Based on the ZIP load model in (7), it can be reduced to (8) such that it is a linearized voltage-dependent load with $a_0 = 0$. The equation can be represented in linear algebraic form as (9)

$$I = \frac{P}{V} = P_0\left(\frac{a_0}{V} + a_1 + a_2V\right) \quad (8)$$

$$\begin{bmatrix} \mathbf{I}_p \\ \mathbf{I}_n \\ \mathbf{I}_b \end{bmatrix}_L = \begin{bmatrix} \mathbf{P}_0\mathbf{a}_{2,p} & \mathbf{0} & \mathbf{0} \\ \mathbf{0} & \mathbf{P}_0\mathbf{a}_{2,n} & \mathbf{0} \\ \mathbf{0} & \mathbf{0} & \mathbf{P}_0\mathbf{a}_{2,b} \end{bmatrix} \begin{bmatrix} \mathbf{V}_p \\ \mathbf{V}_n \\ \mathbf{V}_b \end{bmatrix}_L + \begin{bmatrix} \mathbf{P}_0\mathbf{a}_{1,p} \\ \mathbf{P}_0\mathbf{a}_{1,n} \\ \mathbf{P}_0\mathbf{a}_{1,b} \end{bmatrix} \quad (9)$$

where $\mathbf{P}_0\mathbf{a}_{2,p/n/b}$ and $\mathbf{P}_0\mathbf{a}_{1,p/n/b}$ represent the matrices of the linearized load parameters for a positive, negative and bipolar role distribution load, respectively.

III. OPTIMIZATION-BASED MODELING

A binary integer load distribution model is developed to model the distribution of unipolar DC loads to either the positive or negative distribution pole of the 2-phase bipolar DC network. It is used with the power flow model to develop system voltage unbalance and power loss model for multi-objective optimization for the planning of 2-phase bipolar DC network.

A. Binary Load Distribution Model

In the 2-phase network, while a bipolar load is distributed by the bipolar pole, the unipolar loads can be distributed to either of the positive or negative pole distribution pole. As

voltage unbalance occurs due to the serious asymmetrical loading of the unipolar loads, the unipolar loads are re-distributed into 2 sets of load at roughly similar power levels defined as \mathbf{I}_u and \mathbf{I}_v such that serious asymmetrical loading does not occur as shown in Fig. 2.

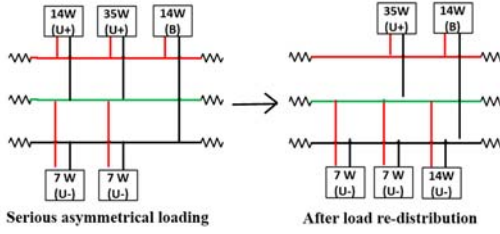

Fig. 2. System diagram of load distribution for 2-phase DC network.

As the load re-distribution involves 2 distribution poles, a binary integer is used to model the selection. By convention, a binary integer of 1 implies the distribution of the load current to the positive pole while a binary integer of 0 implies the distribution of the load current to the negative pole. As such, in the positive distribution pole, a binary integer of 1 on the current set \mathbf{I}_u to the positive pole implies a binary integer of 0 on the current set \mathbf{I}_v . The opposite is true for the negative rail. In vector form, the binary distribution vector \mathbf{X} on one of the current set vectors, \mathbf{I}_u and \mathbf{I}_v , implies the distribution vector of $(\mathbf{1} - \mathbf{X})$ onto the other set. The resulting unipolar load vector across the positive and negative distribution pole can be defined as the following (10) and (11), respectively.

$$\mathbf{I}_p = \mathbf{X}\mathbf{I}_u + (\mathbf{1} - \mathbf{X})\mathbf{I}_v \quad (10)$$

$$\mathbf{I}_n = (\mathbf{1} - \mathbf{X})\mathbf{I}_u + \mathbf{X}\mathbf{I}_v \quad (11)$$

Equations (10) and (11) can be re-expressed into linear algebraic form in (12). The linear algebraic equation is a linear dependent function of the distribution binary vector \mathbf{X} .

$$\begin{bmatrix} \mathbf{I}_p \\ \mathbf{I}_n \\ \mathbf{I}_b \end{bmatrix}_L = \begin{bmatrix} \mathbf{I}_v \\ \mathbf{I}_u \\ \mathbf{I}_b \end{bmatrix} + \begin{bmatrix} \mathbf{I} & -\mathbf{I} \\ -\mathbf{I} & \mathbf{I} \\ \mathbf{0} & \mathbf{0} \end{bmatrix} \begin{bmatrix} \text{diag}(\mathbf{I}_u) & \mathbf{0} \\ \mathbf{0} & \text{diag}(\mathbf{I}_v) \end{bmatrix} \begin{bmatrix} \mathbf{I} \\ \mathbf{I} \end{bmatrix} [\mathbf{X}] \quad (12)$$

where \mathbf{I} is the identity matrix. $\mathbf{I}_{p/n/b}$ are current vectors representing the positive, negative and bipolar pole load current. \mathbf{I}_u and \mathbf{I}_v are the load current vectors representing two sets of roughly similar power levels. \mathbf{X} is the independent vector representing the binary load distribution selection of 1 and 0. 1 represents the selection of the \mathbf{I}_u and \mathbf{I}_v to be distributed to the positive rail while 0 represents the distribution to the negative rail.

B. System Power Loss Model

Without the loss of generality, the system power loss model for bipolar DC network is modeled as the summation of the squares of the distributed load currents with the network resistance. Mathematically, it can be represented in linear algebraic form as (13)

$$\mathbf{P}_L = \begin{bmatrix} \mathbf{I}_+ \\ \mathbf{I}_N \\ \mathbf{I}_- \end{bmatrix}_L^T \begin{bmatrix} \mathbf{G}_L & \mathbf{0} & \mathbf{0} \\ \mathbf{0} & \mathbf{G}_L & \mathbf{0} \\ \mathbf{0} & \mathbf{0} & \mathbf{G}_L \end{bmatrix}^{-1} \begin{bmatrix} \mathbf{I}_+ \\ \mathbf{I}_N \\ \mathbf{I}_- \end{bmatrix}_L \quad (13)$$

where $[\mathbf{I}_+ \ \mathbf{I}_N \ \mathbf{I}_-]_L^T$ represents the load nodes network current, respectively, and \mathbf{G}_L as the same representation in (5).

Substituting (1) to (3) and (10) to (12), the system level

power loss model (13) is simplified to a binary integer quadratic model as shown in (14) with the matrices described in (15). Vector \mathbf{X} represents the binary distribution of the unipolar loads. The derivation of (14) is shown in Appendix B.

$$\mathbf{P}_L[\mathbf{X}] = \mathbf{X}^T \mathbf{A} \mathbf{X} + \mathbf{B} \mathbf{X} + \mathbf{C} \quad (14)$$

$$\mathbf{A} = [\mathbf{D}\mathbf{F}]^T \mathbf{R} [\mathbf{D}\mathbf{F}], \mathbf{B} = 2[\mathbf{D}\mathbf{E}]^T \mathbf{R} [\mathbf{D}\mathbf{F}], \mathbf{C} = [\mathbf{D}\mathbf{E}]^T \mathbf{R} [\mathbf{D}\mathbf{E}]$$

$$\mathbf{D} = \begin{bmatrix} \mathbf{I} & \mathbf{0} & \mathbf{I} \\ -\mathbf{I} & \mathbf{I} & \mathbf{0} \\ \mathbf{0} & -\mathbf{I} & -\mathbf{I} \end{bmatrix}, \mathbf{E} = \begin{bmatrix} \mathbf{I}_v \\ \mathbf{I}_u \\ \mathbf{I}_b \end{bmatrix}, \mathbf{R} = \begin{bmatrix} \mathbf{G}_L & \mathbf{0} & \mathbf{0} \\ \mathbf{0} & \mathbf{G}_L & \mathbf{0} \\ \mathbf{0} & \mathbf{0} & \mathbf{G}_L \end{bmatrix}^{-1} \quad (15)$$

$$\mathbf{F} = \begin{bmatrix} \mathbf{I} & -\mathbf{I} \\ -\mathbf{I} & \mathbf{I} \\ \mathbf{0} & \mathbf{0} \end{bmatrix} \begin{bmatrix} \text{diag}(\mathbf{I}_u) & \mathbf{0} \\ \mathbf{0} & \text{diag}(\mathbf{I}_v) \end{bmatrix} \begin{bmatrix} \mathbf{I} \\ \mathbf{I} \end{bmatrix},$$

C. System Voltage Unbalance Model

System voltage unbalance represents the degree of asymmetrical loading in the 2-phase network. The system voltage unbalance is calculated by taking the summation of the square difference of both positive and negative distribution pole load voltages as shown in (16). In the case of symmetrical voltage, the difference is zero. In vector form, it is represented in (17)

$$V_{un} = \sum_{i=1}^n \left[(V_{p(i)} - V_{n(i)})^2 \right] \quad (16)$$

$$\mathbf{V}_{un} = (\mathbf{V}_p - \mathbf{V}_n)^T (\mathbf{V}_p - \mathbf{V}_n) \quad (17)$$

Reducing (17) using (1) to (3), (17) can be simplified to a binary integer quadratic expressed as (18) with the matrices described in (15) and (19). The detailed derivation of (19) is described in Appendix C.

$$\mathbf{V}_{un}[\mathbf{X}] = \mathbf{X}^T \mathbf{J} \mathbf{X} + \mathbf{K} \mathbf{X} + \mathbf{L} \quad (18)$$

$$\mathbf{J} = [\mathbf{G}\mathbf{R}\mathbf{F}]^T [\mathbf{G}\mathbf{R}\mathbf{F}], \mathbf{K} = 2[\mathbf{G}\mathbf{R}\mathbf{E}]^T [\mathbf{G}\mathbf{R}\mathbf{F}],$$

$$\mathbf{L} = [\mathbf{G}\mathbf{R}\mathbf{E}]^T [\mathbf{G}\mathbf{R}\mathbf{E}], \mathbf{H} = \begin{bmatrix} 3\mathbf{I} & -3\mathbf{I} & \mathbf{0} \\ \mathbf{0} & \mathbf{0} & \mathbf{0} \\ \mathbf{0} & \mathbf{0} & \mathbf{0} \end{bmatrix} \quad (19)$$

D. Flag Model

In analyzing the solutions, there are two cases which do not provide a unique answer, such that the binary vector \mathbf{X} and $(\mathbf{1} - \mathbf{X})$ gives the same results. The mathematical representation can be expressed as (20) and is used as a constraint function in the optimization algorithm.

Case 1): As the current set vectors, \mathbf{I}_u and \mathbf{I}_v are interchangeable, without fixing the \mathbf{I}_u or \mathbf{I}_v , the binary vector \mathbf{X} and $(\mathbf{1} - \mathbf{X})$ gives the same results. As a result, a constraint is proposed such that the first unipolar load of \mathbf{I}_u is distributed in the positive rail. This fixes the starting value of the distribution vector \mathbf{X} to 1 which solves the problem of interchangeable current sets.

Case 2): The second case is when a system network node has the same load model in the set \mathbf{I}_u and \mathbf{I}_v . One example of such a case is when node is distributing only bipolar loads. As a result, the selection of 1/0 of the unipolar load current set affects the accuracy of the results as both gives the same value. Hence, to solve this problem, a constraint of value 1 is proposed at the node when the case of the same load model is identified in the system.

$$\mathbf{H}[\mathbf{X}] = \begin{cases} 1, & \text{case 1 or 2 identified} \\ 0, & \text{else} \end{cases} \quad (20)$$

IV. MULTI-OBJECTIVE OPTIMIZATION METHOD

A. Multi-Objective Weighted Sum Method

This paper proposes a multi-objective optimization (MOO) method for simultaneously minimizing the power loss and voltage unbalance. The objective is to minimize the two indices, the system power loss and the system voltage unbalance index through weighted sum of them. The constraint taken is the flag model which discusses the cases when the dependent variable does not output a unique value.

In the weighted sum approach, weights are attached to each of the individual objective function. The functions of the attached weights are to normalize the indices to its per-unit value and to represent their relative importance with respect to each index.

In addition, a scaling factor is added to the system power loss objective. A large scaling factor implies that the system power loss is a large multiplier of the normalized value of the system power loss. It should be noted that the use of DC systems for distribution is mainly for higher energy efficiency and a large scaling factor implies high system inefficiency. The objective and constraints functions are formulated as (21) and (22), respectively.

$$\mathbf{G}[\mathbf{X}] = \min \frac{\alpha_1 * w_1}{n_1} \mathbf{P}_L[\mathbf{X}] + \frac{w_2}{n_2} \mathbf{V}_{un}[\mathbf{X}] \quad (21)$$

$$\text{s.t.} \quad \mathbf{H}[\mathbf{X}] \quad (22)$$

where $\mathbf{G}[\mathbf{X}]$ represents the MOO function and $w_1, n_1, \mathbf{P}_L[\mathbf{X}]$ and $w_2, n_2, \mathbf{V}_{un}[\mathbf{X}]$ represents the weight, normalised value and the model for system power loss and system voltage unbalance respectively. α_1 represents the scaling factor of the system power loss to indicate an efficient system design.

The values used for normalizing the system power loss and the system voltage unbalance model, n_1 and n_2 are 15% of the rated load power and the number of nodes, respectively. The weight is set as 0.5 to illustrate the equal weighting of the considerations during power system planning of the bipolar 2-phase network. The scaling factor is selected to be within a conservative range from 0.8 to 2 to illustrate an energy efficient DC system design.

To solve a multi-objective programming model, another popular method is multi-objective evolutionary algorithms such as NSGA-II [37] and MOEA/D [38]. However, these algorithms usually need a very large number of generation and population number, thus considerable computing time; besides, they usually provide inconsistent solutions for multiple runs due to the random factors involved. Therefore, this paper uses the weighted-sum method.

B. Solution Algorithm

In solving for the MOO model, the problem is divided into two parts. The first part is to obtain the load currents by formulating the matrices and solve the power flow equations for the bipolar DC network. The second part is to use the load current values and form the system power loss and voltage unbalance model and solve the MOO model with the constraint function using the flag model. The flowchart of the described solution process is shown in Fig. 3 and commercial

solvers such as IBM ILOG CPLEX can be used in practice.

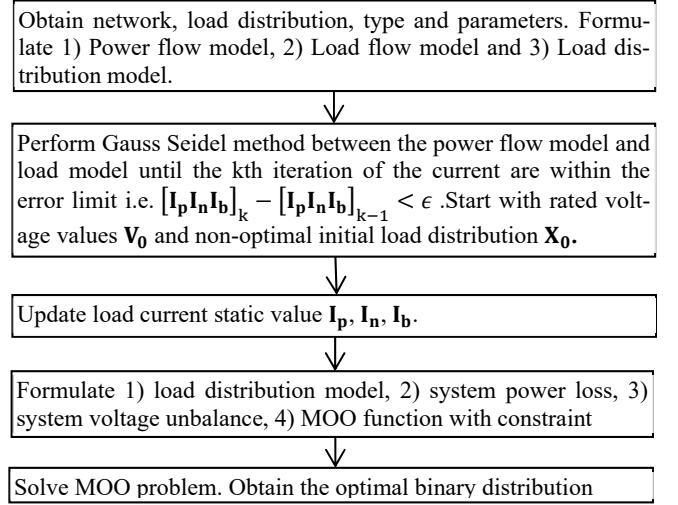

Fig. 3. Solution flowchart

V. SIMULATION RESULTS

A. Case Study: DC LED Lighting Radial Network

One distribution network example that exhibits a highly resistive network, high voltage unbalance and a relatively non-negligible voltage drop is the retrofitted extra-low voltage DC LED lighting system for high-rise buildings [12]. The DC LED lighting system can also be integrated with DERs to form a non-observable distribution network [13]. Subsequently, the DC LED lighting load is used as the main load model for the case studies. The DC LED lighting uses OSRAM DURIS S5 LEDs of array 7 series by 6 parallel, of total 7W, powered by the RECOM RCD-24 or RCD-48 DC driver. The empirical data measurement of the DC LED lighting load is given in Fig. 4.

Using the linearized load model as the basic model, variations of unipolar or bipolar DC loads are obtained by varying the input power P_0 variable. The parameters of the different loads are given in Appendix D.

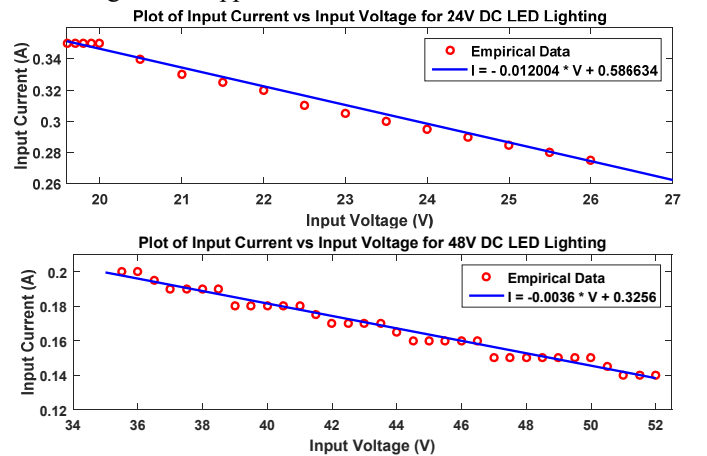

Fig. 4. Plot of 7W load model for a) 24V DC LED lighting and b) 48V DC LED lighting

B. Power Flow Modeling Verification

The first case study is a 15-node 2-phase bipolar DC LED

lighting radial network. The load model and electrical network parameters are shown in Appendix D. The electrical system diagram and load distribution are shown in Fig. 5.

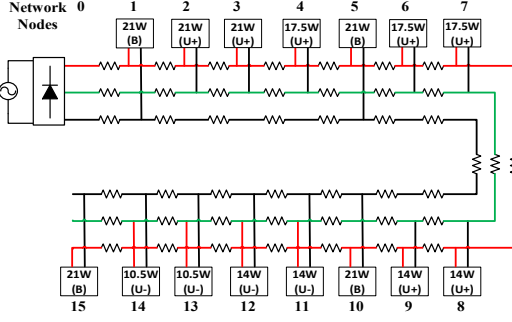

Fig. 5. System Diagram of Bipolar DC Radial 15-Bus Network

Two types of simulation are carried out for this case study. The first is the verification of the power flow mathematical model against the Matlab Simulink simulation model as the benchmark, and the second is the comparison of voltage balancing strategies with existing methodologies, which is discussed in the next sub-section.

TABLE I: ERROR COMPARISON OF NODE VOLTAGE VALUES

Error (10^{-5} V DC)			Error (10^{-5} V DC)		
Node	$V_{p(i)}$	$V_{n(i)}$	Node	$V_{p(i)}$	$V_{n(i)}$
0	0	0	8	9.3207	9.2614
1	8.5828	8.1210	9	9.3328	8.9309
2	8.9763	8.6374	10	9.3243	8.5707
3	9.0695	8.4539	11	9.3135	9.5083
4	8.1938	8.9050	12	9.3054	9.4903
5	9.2132	8.7084	13	9.2372	8.6925
6	9.2542	7.5335	14	9.3039	9.2151
7	9.2140	8.6492	15	9.2725	9.2937

In the verifying the power flow mathematical model, the initial binary distribution is used. Table I shows that the nodal voltage error between the mathematical model and the Matlab Simulink simulation model is within an order magnitude of 10^{-5} . It can be shown in Fig. 6 that the phase voltages are not balanced under the initial binary distribution. The distribution voltage used is 24V DC. Consequently, the following is seen: 1) The proposed power flow model is highly accurate, and 2) The voltage unbalance for each load node is not consistent across the system, as seen in Fig. 6. The extra-low DC voltage LED lighting system is a suitable case study for the mathematical model verification and voltage balancing strategy comparison as the voltage drop across the system is non-negligible, up to 15% pu drop.

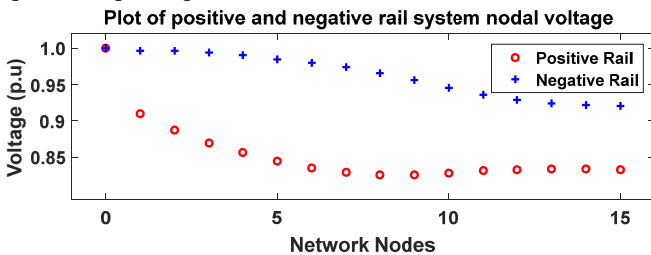

Fig. 6. Plot of phase node voltage in an unbalanced 15-bus network

C. Voltage Balancing Strategies Comparison

The same linear network is used to compare the voltage balancing strategies between the proposed model-based opti-

mization methodology and existing methodologies. The linear network is used because in existing methodologies, iterative methodology is used and is only suitable when the power flow is observable. The iterative algorithm of [5] and [12] are briefly described in Table II and III respectively.

TABLE II: VOLTAGE BALANCING ALGORITHM USING NEUTRAL CURRENT

Algorithm 1: Minimize absolute value of neutral current

Label Network Nodes: 0 to n

Start: Node n

Distribute the last load to the positive rail

While (Node \neq 1)

If (neutral cable current is positive),

Distribute the next load to the negative rail

Minus the value of the neutral cable current

Else

Distribute the next load to the positive rail

Add the value of the neutral cable current

End

Node = Node - 1

End

TABLE III: VOLTAGE BALANCING ALGORITHM USING NODAL VOLTAGE

Algorithm 2: Distribute the loads based on voltage level

Label Network Nodes: 0 to n

Start: Node n

Distribute the last load to the positive rail

While (Node \neq 1)

If (positive phase voltage > negative phase voltage),

Distribute the next load to the positive rail

Re-calculate the phase voltages

Else

Distribute the next load to the negative rail

Re-calculate the phase voltages

End

Node = Node - 1

End

For the proposed model-based optimization approach, the values used for normalizing, n_1 and n_2 , are 38.325 and 15, respectively for the discussed linear network case study. The weight is set as 0.5 to illustrate the equal weighting of the considerations during power system planning of the bipolar 2-phase network. The scaling factor is selected to be within a conservative range from 0.8 to 2.

The compared voltage balancing strategies are as follows: Case 1) Proposed MOO method with the following weights, $w_1, w_2 = 0.5$ and $0.8 < \alpha_1 < 2$. Case 2) Base case study. Case 3) Backward forward sweep based on the absolute value of the rated current in the neutral wire [5]. Case 4) Backward forward sweep based on network voltage with consideration of network impedance [12]. Case 5) MOO with the following weights, $w_2 = 0, w_1, \alpha_1 = 1$. Note that Case 1 represents a reasonable weightage for the power system planning while Case 5) represents when only the system power loss is considered.

TABLE IV: BINARY DISTRIBUTION VECTOR OF THE 5 CASES

Node	Cases					Node	Cases				
	1)	2)	3)	4)	5)		1)	2)	3)	4)	5)
1	1	1	1	1	1	9	1	1	1	1	1
2	1	1	1	1	1	10	1	1	1	1	1
3	0	1	0	0	0	11	0	0	0	1	0
4	1	1	1	1	1	12	0	0	1	0	0

5	1	1	1	1	1	13	1	0	0	0	1
6	0	1	0	1	0	14	1	0	1	1	1
7	0	1	1	0	1	15	1	1	1	1	1
8	1	1	0	0	0	-	-	-	-	-	-

TABLE V: COMPARISON TABLE OF INDICES FOR 15 BUS NETWORK

Cases	Power Loss (15)		Voltage Unbalance (18)	
	(W)	(p.u)	-	(p.u)
1)	27.0744	0.7064	0.1822	0.0121
2)	34.4801	0.8997	120.2442	8.0163
3)	27.3073	0.7125	13.6397	0.9093
4)	27.2310	0.7105	7.1299	0.4753
5)	27.0490	0.7058	2.1790	0.1453

Table IV shows the binary load distribution solutions of the 5 abovementioned cases and Table V compares the system power loss and system voltage unbalance values of the corresponding cases. Fig 7 shows the balanced nodal voltages of the 2 phases after voltage balancing and Fig. 8 shows the plot of the indices of the load distribution solutions.

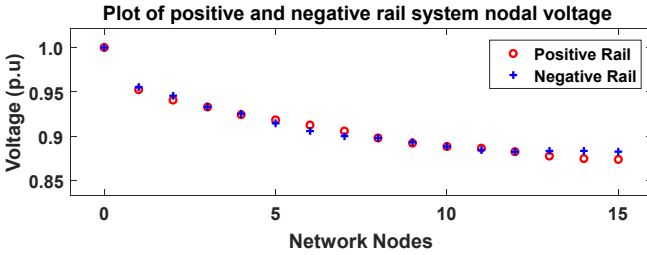

Fig. 7. Plot of phase node voltage in a balanced 15-bus network

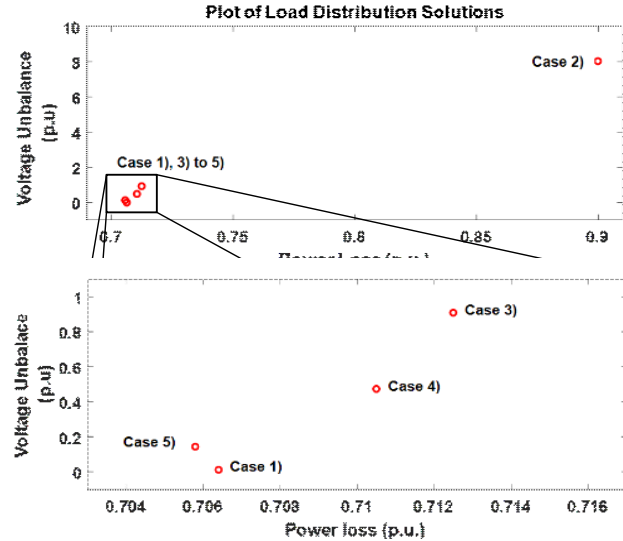

Fig. 8. Comparison plot of voltage balancing solutions

D. Case Study: A Larger 33-Bus System

The power flow model and proposed voltage balancing methodology are then tested on a larger system, a 33-bus system, using DC LED lighting system as the case study. The 33-bus system is used to illustrate the effects of non-observable power flow such that iterative methods are not easily applied and the effects of large systems on the voltage balancing proposed methodology. The 33-bus system single line diagram, load distribution and load power are shown in Fig. 9. The load to load distance is set at 5m. The electrical network details are the same as the linear system.

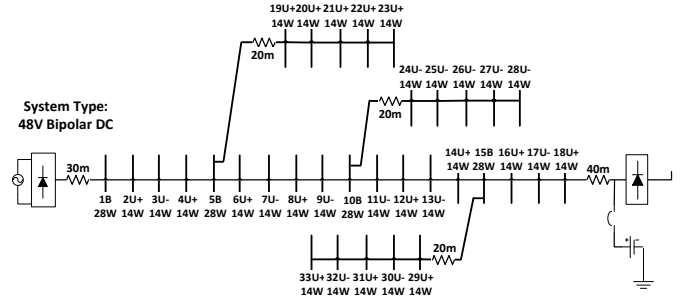

Fig. 9. System Diagram of Bipolar DC Radial 33-Bus Network

TABLE VI: ERROR COMPARISON OF NODE VOLTAGE VALUES

Node	Error (10^{-4} V DC)		Node	Error (10^{-4} V DC)	
	$V_{p(i)}$	$V_{n(i)}$		$V_{p(i)}$	$V_{n(i)}$
0	0	0	17	1.5230	1.1700
1	1.3565	0.5737	18	1.3918	1.0210
2	1.5814	0.6681	19	2.9464	0.5410
3	1.7639	0.7837	20	3.1094	0.4594
4	1.9680	0.8561	21	3.2316	0.3984
5	2.1301	0.9494	22	3.3130	0.3577
6	2.0862	1.1428	23	3.3537	0.3373
7	2.0005	1.3571	24	1.3301	2.7007
8	1.9362	1.5287	25	1.2472	2.8665
9	1.8300	1.7213	26	1.1851	2.9906
10	1.7450	1.8714	27	1.1438	3.0734
11	1.7614	1.8118	28	1.1231	3.1147
12	1.7990	1.7098	29	2.1177	1.4934
13	1.7945	1.6289	30	2.1587	1.5371
14	1.8113	1.5054	31	2.2210	1.5380
15	1.7860	1.4030	32	2.2415	1.5598
16	1.6757	1.2759	33	2.2834	1.5389

The nodal voltage errors of the 33-bus system are shown in Table VI where it can be seen that the mean error between the mathematical model and the Matlab Simulink simulation model is within an order magnitude of 10^{-4} . This validates again the very high accuracy of the proposed power flow model for 2-phase bipolar DC network.

TABLE VII: COMPARISON TABLE OF INDICES FOR 33 BUS NETWORK

Node	1	2	3	4	5	6	7	8	9	10	11
Case 1	1	1	1	0	1	1	0	1	1	1	0
Case 2	1	1	0	1	1	1	0	1	0	1	0
Node	12	13	14	15	16	17	18	19	20	21	22
Case 1	1	0	1	1	1	0	1	0	0	1	0
Case 2	1	0	1	1	1	0	1	1	1	1	1
Node	23	24	25	26	27	28	29	30	31	32	33
Case 1	1	0	0	1	0	1	0	0	1	0	1
Case 2	1	0	0	0	0	0	1	0	1	0	1

TABLE VIII: COMPARISON TABLE OF INDICES FOR 33 BUS NETWORK

Cases	Power Loss (15)		Voltage Unbalance (18)	
	(W)	(p.u)	-	(p.u)
1	53.3198	1.0664	1.4350	0.0435
2	69.1298	1.3826	181.4156	5.4974

TABLE IX: COMPARISON TABLE OF INDICES FOR 33 BUS NETWORK

Case Study	15-Bus System	33-Bus System
Computational Time	0.20 s	31132.75 s

The proposed MOO methodology formulates the problem into mixed integer quadratic problem (MIQP). It is well known that MIQP has a computational complexity which grows exponentially with the number of optimization variables [39]. The simulation uses the values of $w_1, w_2 = 0.5$, $\alpha_1 =$

1, $n_1 = 50$ and $n_2 = 33$.

The compared performances of the binary distribution solution are as follows: Case 1) Proposed MOO method with the following weights, $w_1, w_2 = 0.5$, $\alpha_1 = 1$, $n_1 = 50$ and $n_2 = 33$; Case 2) Base case study. Table VII shows the binary distribution solutions while Table VIII compares the system power loss and system voltage unbalance values of the corresponding cases. Table IX compares the computational time in the voltage balancing planning for a 15-bus and 33-bus system. Using the 33-bus system as the case study, it can be seen from Table VIII and Table IX that the proposed model-based MOO method has successfully shown that the voltage across the 2-phase bipolar DC network is balanced and can be carried out with reasonably fast solution speed (note that the proposed method is mainly for system analysis and planning studies, so the computational time is not a major concern as long as the solution can be obtained in a tolerable time, e.g., several hours). Fig. 10 shows the nodal voltages of the balanced 33-bus 2-phase DC network.

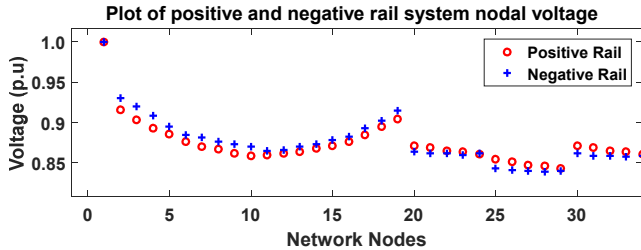

Fig. 10. Plot of phase node voltage in a balanced 33-bus network

VI. DISCUSSION AND CONCLUSION

This paper presents a power flow model for 2-phase bipolar DC power system and a model-based optimization methodology for designing 2-phase bipolar DC power system. The power flow modeling methodology considers the single-line modeling for the cables in the 2-phase DC network, the distribution of the load and formulates the power flow model. The model is iterated using the Gauss Seidel algorithm and shows highly accurate results compared to the Matlab Simulink results. Together with the power flow model and a binary load distribution model, a multi-objective weighted sum optimization problem based on system power loss and system voltage unbalance is formulated as a binary integer quadratic problem.

According to the simulation results, the following conclusion can be drawn:

- 1) The proposed power flow model is highly accurate with an error of 10^{-4} V DC against the Matlab Simulink nodal voltages. Compared with the existing iterative methods, the proposed power flow method is able to model the nodal voltages with high accuracy of order of magnitude of 10^{-4} error without having to determine the parent and child nodes in a multiple DC power sources complex network as seen in the 33-bus case study.
- 2) In comparing between existing and proposed model-based voltage balancing strategies, the proposed methodology can reduce system voltage unbalance by up to 95%. As existing methodologies are based on iterative methods, the 15-bus radial network is used as the case study. The

improvement of the results is due to the consideration of i) the effects of voltage drop from the distribution of bipolar DC loads and ii) the consideration of voltage balancing at the whole system level. The proposed methodology is then applied to a 33-bus system and is able to reduce voltage unbalance tremendously.

- 3) The proposed voltage balancing methodology is then extended to a 33-bus unobservable power network case study. The proposed model-based MOO method has successfully shown that the voltage across the 2-phase bipolar DC network is balanced and can be carried out with reasonably fast solution speed.
- 4) Comparing the MOO solutions of the 15-bus radial network, the power loss index of the network between cases 1) and 5) of Table V does not vary significantly. This is seen in the 15-bus radial network that before and after carrying MOO, the power loss reduces by 15%. However, comparing between MOO and power loss single optimization, the power loss reduces by less than 0.1% but the voltage unbalance doubles as seen in Table V. This is due to the presence of an upper bound to minimizing system power loss which arises from the rationale of energy efficient system design in using DC distribution. In the situation when the scaling factor α_1 is larger than 2, it implies that the DC power distribution system is inefficient. One possible way to improve efficiency is to increase the DC distribution voltage such that the system power loss lies within the normalized value as designed.

The proposed power flow modeling is also able to provide an overall view of the DC power systems for further network optimization to be carried out in the design and planning stage. It is able to be integrated with emerging technological advances such as direct integration of DC energy storage systems, direct connection and disconnection of DC energy sources and improve the time series power flow analysis together with the consideration of droop control and virtual impedance.

The proposed voltage balancing method is a planning tool to improve on voltage balancing and system efficiency of bipolar DC networks and it depends heavily on the assumption made in the bipolar DC network modelling. It can be applied in a design and planning of such a network, such as DC LED lighting system design and residential DC buildings network. Some of the future works can include voltage balancing of bipolar DC network with multiple single phase DC source integration and unequal node to node resistances in future DC residential networks. The proposed method can be further extended and modified to account for the abovementioned future works.

APPENDIX

A. Power Flow Model

Consider power flow nodal based linear equations.

$$\mathbf{I} = \mathbf{YV} \quad (\text{A-1})$$

Separating the source and load nodes in the main equation, the source admittance matrix, \mathbf{Y}_S , corresponds to the impedance between sources and the load network.

$$\mathbf{I}_L + \mathbf{I}_S = \mathbf{Y}_1 \mathbf{V}_L + \mathbf{Y}_S \mathbf{V}_S \quad (\text{A-2})$$

At distribution level, the source current is not always readily available but it can be determined by modeling the node load voltages with a high degree of accuracy. Consequently, the source current component is removed.

$$\mathbf{I}_L = \mathbf{Y}_1 \mathbf{V}_L + \mathbf{Y}_S \mathbf{V}_S \quad (\text{A-3})$$

Re-expressing the load impedance matrix, \mathbf{Y}_1 , as the sum of source and load impedance, \mathbf{Y}_L and \mathbf{Y}_S , the equation can be decomposed into the following equation.

$$\mathbf{I}_L = (\mathbf{Y}_L + \mathbf{Y}_S) \mathbf{V}_L + \mathbf{Y}_S \mathbf{V}_S \quad (\text{A-4})$$

B. System Power Loss Model

The system power loss is modeled as (13). Taking the definition of current as the summation of load type currents in (1) to (3), (13) can be decomposed in (B-1) with the terms represented in (15)

$$\mathbf{P}_L = \left(\mathbf{D} \begin{bmatrix} \mathbf{I}_p \\ \mathbf{I}_n \\ \mathbf{I}_b \end{bmatrix} \right)^T \mathbf{R} \left(\mathbf{D} \begin{bmatrix} \mathbf{I}_p \\ \mathbf{I}_n \\ \mathbf{I}_b \end{bmatrix} \right) \quad (\text{B-1})$$

Substituting the load distribution model, (B-1) can be expressed as (B-2) with the terms represented in (15) and (19).

$$\mathbf{P}_L[\mathbf{X}] = (\mathbf{D}[\mathbf{E} + \mathbf{F}\mathbf{X}])^T \mathbf{R}(\mathbf{D}[\mathbf{E} + \mathbf{F}\mathbf{X}]) \quad (\text{B-2})$$

Upon expansion, (B-2) can be simplified to a binary integer quadratic model as shown in (B-3) and (14).

$$\mathbf{P}_L[\mathbf{X}] = \mathbf{X}^T \mathbf{A}\mathbf{X} + \mathbf{B}\mathbf{X} + \mathbf{C} \quad (\text{B-3})$$

C. System Voltage Unbalance Model

The voltage unbalance model is modeled as (17). Taking the definition of voltage as the potential difference between two voltage nodes, i.e., $V_p = V_+ - V_N$ and $V_n = V_N - V_-$, (17) can be decomposed in (C-1).

$$\mathbf{V}_{un} = (\mathbf{V}_+ - 2\mathbf{V}_N + \mathbf{V}_-)^T (\mathbf{V}_+ - 2\mathbf{V}_N + \mathbf{V}_-) \quad (\text{C-1})$$

Further reduction using the nodal analysis equations (1) to (3), (C-1) can be reduced to (C-2) with the assumption made that the cable is multi core and the node to node resistance is the same for each distribution cable, ie $\mathbf{G} = \mathbf{G}_+ = \mathbf{G}_N = \mathbf{G}_-$

$$\mathbf{V}_{un} = \left(3\mathbf{R}(\mathbf{I}_p - \mathbf{I}_n) \right)^T \left(3\mathbf{R}(\mathbf{I}_p - \mathbf{I}_n) \right) \quad (\text{C-2})$$

(C-2) can be linearly expressed as (C-3)

$$\mathbf{V}_{un} = \left(\mathbf{R}\mathbf{H} \begin{bmatrix} \mathbf{I}_p \\ \mathbf{I}_n \\ \mathbf{I}_b \end{bmatrix} \right)^T \left(\mathbf{R}\mathbf{H} \begin{bmatrix} \mathbf{I}_p \\ \mathbf{I}_n \\ \mathbf{I}_b \end{bmatrix} \right) \quad (\text{C-3})$$

Substituting the load distribution model, (C-2) can be expressed as (B-3) with the terms represented in (15) and (19).

$$\mathbf{V}_{un}[\mathbf{X}] = (\mathbf{R}\mathbf{H}[\mathbf{E} + \mathbf{F}\mathbf{X}])^T (\mathbf{R}\mathbf{H}[\mathbf{E} + \mathbf{F}\mathbf{X}]) \quad (\text{C-4})$$

Upon expansion and simplification, the model can be expressed as a binary integer quadratic model as shown in (C-5).

$$\mathbf{V}_{un}[\mathbf{X}] = \mathbf{X}^T \mathbf{J}\mathbf{X} + \mathbf{K}\mathbf{X} + \mathbf{L} \quad (\text{C-5})$$

D. Load and Electrical Network Parameters

TABLE X: LOAD PARAMETER VALUE FOR SIMULATION

Power (W)	P_0	a_0	a_1	a_2
28 (B)	4	0	-0.0036	0.3256
21 (B)	3	0	-0.0036	0.3256
7 (B)	1	0	-0.0036	0.3256
21 (U)	3	0	-0.012004	0.586634
17.5 (U)	2.5	0	-0.012004	0.586634

14 (U)	2	0	-0.012004	0.586634
10.5 (U)	1.5	0	-0.012004	0.586634
7 (U)	1	0	-0.012004	0.586634

TABLE XI: 2-PHASE DC ELECTRICAL NETWORK PARAMETERS

	Parameters		Values
	Electrical Network Properties	Cable Size	
Line Resistance			0.0074Ω/m
Length between Load Nodes			5m
Length between converter and first LED lighting (Radial Network)			20m
Derated Factor			0.8
Rated line voltage			24V DC

VII. REFERENCES

- [1] J. J. Justo, F. Mwasilu, J. Lee, and J.-W. Jung, "AC-microgrids versus DC-microgrids with distributed energy resources: A review," *Renewable and Sustainable Energy Reviews*, vol. 24, no. Supplement C, pp. 387-405, 2013/08/01/ 2013.
- [2] H. Kakigano, Y. Miura, and T. Ise, "Low-Voltage Bipolar-Type DC Microgrid for Super High Quality Distribution," *Power Electronics, IEEE Transactions on*, vol. 25, no. 12, pp. 3066-3075, 2010.
- [3] M. Noritake, T. Iino, A. Fukui, K. Hirose, and M. Yamasaki, "A study of the safety of the DC 400 V distribution system," in *Telecommunications Energy Conference, 2009. INTELEC 2009. 31st International*, 2009, pp. 1-6.
- [4] G. Byeon, T. Yoon, S. Oh, and G. Jang, "Energy Management Strategy of the DC Distribution System in Buildings Using the EV Service Model," *IEEE Transactions on Power Electronics*, vol. 28, no. 4, pp. 1544-1554, 2013.
- [5] G.-H. Gwon, C.-H. Kim, Y.-S. Oh, C.-H. Noh, T.-H. Jung, and J. Han, "Mitigation of voltage unbalance by using static load transfer switch in bipolar low voltage DC distribution system," *International Journal of Electrical Power & Energy Systems*, vol. 90, pp. 158-167, 9/ 2017.
- [6] K. T. Mok, M. H. Wang, S. C. Tan, and S. Y. R. Hui, "DC Electric Springs - A Technology for Stabilizing DC Power Distribution Systems," *IEEE Transactions on Power Electronics*, vol. 32, no. 2, pp. 1088-1105, 2017.
- [7] J. M. Guerrero, J. C. Vasquez, J. Matas, L. G. d. Vicuna, and M. Castilla, "Hierarchical Control of Droop-Controlled AC and DC Microgrids - A General Approach Toward Standardization," *IEEE Transactions on Industrial Electronics*, vol. 58, no. 1, pp. 158-172, 2011.
- [8] S. Anand, B. G. Fernandes, and J. Guerrero, "Distributed Control to Ensure Proportional Load Sharing and Improve Voltage Regulation in Low-Voltage DC Microgrids," *IEEE Transactions on Power Electronics*, vol. 28, no. 4, pp. 1900-1913, 2013.
- [9] C. Li, S. K. Chaudhary, M. Savaghebi, J. C. Vasquez, and J. M. Guerrero, "Power Flow Analysis for Low-Voltage AC and DC Microgrids Considering Droop Control and Virtual Impedance," *IEEE Transactions on Smart Grid*, vol. 8, no. 6, pp. 2754-2764, 2017.
- [10] B. Kroposki, R. Lasseter, T. Ise, S. Morozumi, S. Papanthassiou, and N. Hatziaargyriou, "Making microgrids work," *IEEE Power and Energy Magazine*, vol. 6, no. 3, pp. 40-53, 2008.
- [11] G. W. Chang, S. Y. Chu, and H. L. Wang, "An Improved Backward/Forward Sweep Load Flow Algorithm for Radial Distribution Systems," *Power Systems, IEEE Transactions on*, vol. 22, no. 2, pp. 882-884, 2007.
- [12] S. H. Chew, K. J. Tseng, and H. T. Nguyen, "An energy efficient 48Vdc bipolar ELVDC LED lighting system in a high-rise building," in *2015 IEEE 11th International Conference on Power Electronics and Drive Systems*, 2015, pp. 35-40.
- [13] S.H.Chew *et al.*, "Design Considerations for ELVDC Power Distribution System Integrated Directly with DC Energy Sources for LED Lighting in High-Rise Built Environment," in *Telecommunications Energy Conference (INTELEC), 2015 IEEE 37th International Conference on*, 2015.
- [14] S. Anand and B. G. Fernandes, "Reduced-Order Model and Stability Analysis of Low-Voltage DC Microgrid," *IEEE Transactions on Industrial Electronics*, vol. 60, no. 11, pp. 5040-5049, 2013.
- [15] J. Han *et al.*, "Modeling and Analysis of a Low-Voltage DC Distribution System," *Resources*, vol. 4, no. 3, 2015.

- [16] N. H. van der Blij, L. M. Ramirez-Elizondo, M. Spaan, and P. Bauer, "A State-Space Approach to Modelling DC Distribution Systems," *IEEE Transactions on Power Systems*, pp. 1-1, 2017.
- [17] N. H. v. d. Blij, L. M. Ramirez-Elizondo, M. T. J. Spaan, and P. Bauer, "Symmetrical Component Decomposition of DC Distribution Systems," *IEEE Transactions on Power Systems*, vol. PP, no. 99, pp. 1-1, 2017.
- [18] G. Yunjie, L. Wuhua, and H. Xiangning, "Analysis and Control of Bipolar LVDC Grid With DC Symmetrical Component Method," *IEEE Transactions on Power Systems*, vol. 31, no. 1, pp. 685-694, 2016.
- [19] L. Mackay, R. Guarnotta, A. Dimou, G. Morales-España, L. Ramirez-Elizondo, and P. Bauer, "Optimal Power Flow for Unbalanced Bipolar DC Distribution Grids," *IEEE Access*, vol. PP, no. 99, pp. 1-1, 2018.
- [20] Y. K. Tan and K. J. Tseng, "Low-Voltage, DC Grid-Powered LED Lighting System with Smart Ambient Sensor Control for Energy Conservation in Green Building," in *Smart Grid Infrastructure & Networking*: McGraw Hill, 2013, pp. 227-248.
- [21] D. L. Gerber, V. Vossos, W. Feng, C. Marnay, B. Nordman, and R. Brown, "A simulation-based efficiency comparison of AC and DC power distribution networks in commercial buildings," *Applied Energy*, 2017/06/12/ 2017.
- [22] L. Tao and A. Domijan, "On power quality indices and real time measurement," *IEEE Transactions on Power Delivery*, vol. 20, no. 4, pp. 2552-2562, 2005.
- [23] A. v. Joanne and B. Banerjee, "Assessment of voltage unbalance," *IEEE Transactions on Power Delivery*, vol. 16, no. 4, pp. 782-790, 2001.
- [24] P. Prabhakaran and V. Agarwal, "Mitigation of voltage unbalance in a low voltage bipolar DC microgrid using a boost-SEPIC type interleaved dc-dc compensator," in *2016 IEEE 2nd Annual Southern Power Electronics Conference (SPEC)*, 2016, pp. 1-6.
- [25] J. Lago and M. L. Heldwein, "Operation and Control-Oriented Modeling of a Power Converter for Current Balancing and Stability Improvement of DC Active Distribution Networks," *IEEE Transactions on Power Electronics*, vol. 26, no. 3, pp. 877-885, 2011.
- [26] S. Rivera and B. Wu, "Electric Vehicle Charging Station With an Energy Storage Stage for Split-DC Bus Voltage Balancing," *IEEE Transactions on Power Electronics*, vol. 32, no. 3, pp. 2376-2386, 2017.
- [27] T. Jung, G. Gwon, C. H. Kim, J. Han, Y. Oh, and C. H. Noh, "Voltage Regulation Method for Voltage Drop Compensation and Unbalance Reduction in Bipolar Low-Voltage DC Distribution System," *IEEE Transactions on Power Delivery*, vol. PP, no. 99, pp. 1-1, 2017.
- [28] M. Chindris, A. Cziker, A. Miron, H. Balan, and A. Sudria, "Propagation of unbalance in electric power systems," in *2007 9th International Conference on Electrical Power Quality and Utilisation*, 2007, pp. 1-5.
- [29] D. Thukaram, J. Jerome, and C. Surapong, "A robust three-phase state estimation algorithm for distribution networks," *Electric Power Systems Research*, vol. 55, no. 3, pp. 191-200, 2000/09/01/ 2000.
- [30] M. F. AlHajri and M. E. El-Hawary, "Exploiting the Radial Distribution Structure in Developing a Fast and Flexible Radial Power Flow for Unbalanced Three-Phase Networks," *IEEE Transactions on Power Delivery*, vol. 25, no. 1, pp. 378-389, 2010.
- [31] F. Gao and S. Bozhko, "Modeling and Impedance Analysis of a Single DC Bus-Based Multiple-Source Multiple-Load Electrical Power System," *IEEE Transactions on Transportation Electrification*, vol. 2, no. 3, pp. 335-346, 2016.
- [32] W. Caisheng and M. H. Nehrir, "Analytical approaches for optimal placement of distributed generation sources in power systems," *IEEE Transactions on Power Systems*, vol. 19, no. 4, pp. 2068-2076, 2004.
- [33] A. Emadi, A. Khaligh, C. H. Rivetta, and G. A. Williamson, "Constant power loads and negative impedance instability in automotive systems: definition, modeling, stability, and control of power electronic converters and motor drives," *Vehicular Technology, IEEE Transactions on*, vol. 55, no. 4, pp. 1112-1125, 2006.
- [34] A. Arif, Z. Wang, J. Wang, B. Mather, H. Bashualdo, and D. Zhao, "Load Modeling - A Review," *IEEE Transactions on Smart Grid*, vol. PP, no. 99, pp. 1-1, 2017.
- [35] A. Bokhari *et al.*, "Experimental Determination of the ZIP Coefficients for Modern Residential, Commercial, and Industrial Loads," *IEEE Transactions on Power Delivery*, vol. 29, no. 3, pp. 1372-1381, 2014.
- [36] J. R. Martí, H. Ahmadi, and L. Bashualdo, "Linear Power-Flow Formulation Based on a Voltage-Dependent Load Model," *IEEE Transactions on Power Delivery*, vol. 28, no. 3, pp. 1682-1690, 2013.
- [37] Y. Xu, X. Xie, Z. Y. Dong, D. J. Hill, and R. Zhang, "Risk-averse multi-objective generation dispatch considering transient stability under load model uncertainty," *IET Generation, Transmission & Distribution*, vol. 10, no. 11, pp. 2785-2791, 2016.
- [38] Y. Xu, Z. Y. Dong, K. Meng, W. F. Yao, R. Zhang, and K. P. Wong, "Multi-Objective Dynamic VAR Planning Against Short-Term Voltage Instability Using a Decomposition-Based Evolutionary Algorithm," *IEEE Transactions on Power Systems*, vol. 29, no. 6, pp. 2813-2822, 2014.
- [39] D. Axehill, "Integer quadratic programming for control and communication," Department of Electrical Engineering, Linköping University, 2008.



Benjamin Si Hao Chew (S'14) received the B.E. (Hons.) degree in electrical (power) engineering from Nanyang Technological University of Singapore, Singapore in 2014. He is currently pursuing the Ph.D. degree in electrical engineering at the School of Electrical and Electronic Engineering, Nanyang Technological University, Singapore. His current research interests include design and planning of efficient and reliable power system applied to DC bipolar network, DC nanogrid and

renewable energy systems.



Yan Xu (S'10-M'13) received the B.E. and M.E. degrees from South China University of Technology, Guangzhou, China in 2008 and 2011, respectively, and the Ph.D. degree from The University of Newcastle, Australia, in 2013. He is now the Nanyang Assistant Professor at the School of Electrical and Electronic Engineering, Nanyang Technological University, Singapore. He was previously with University of Sydney, Australia. His research interests include power system stability and control, microgrid and multi-energy network, and data-analytics for smart grid applications.



Qiuwei Wu (M'08-SM'15) obtained the B. Eng. and M. Eng. in Power System and Its Automation from Nanjing University of Science and Technology, Nanjing, China, in 2000 and 2003, respectively. He obtained the PhD degree in Power System Engineering from Nanyang Technological University, Singapore, in 2009. He was a senior R&D engineer with VESTAS Technology R&D Singapore Pte Ltd from Mar. 2008 to Oct. 2009. He has been working at Department of Electrical Engineering, Technical

University of Denmark (DTU) since Nov. 2009 (PostDoc Nov. 2009-Oct. 2010, Assistant Professor Nov. 2010-Aug. 2013, Associate Professor since Sept. 2013). He was a visiting scholar at Department of Industrial Engineering & Operations Research (IEOR), University of California, Berkeley, from Feb. 2012 to May 2012 funded by Danish Agency for Science, Technology and Innovation (DASTI), Denmark. He has been a visiting professor named by Y. Xue, an Academician of Chinese Academy of Engineering, at Shandong University, China, since Nov. 2015. His research interests are smart grids, wind power, electric vehicle, active distribution networks, electricity market, and integrated energy systems. He is an Editor of *IEEE Transactions on Smart Grid* and *IEEE Power Engineering Letters*. He is also an Associate Editor of *International Journal of Electrical Power and Energy Systems* and *Journal of Modern Power Systems and Clean Energy*.