

Organic Rankine cycle unit for waste heat recovery on ships (PilotORC)

Final report

Report

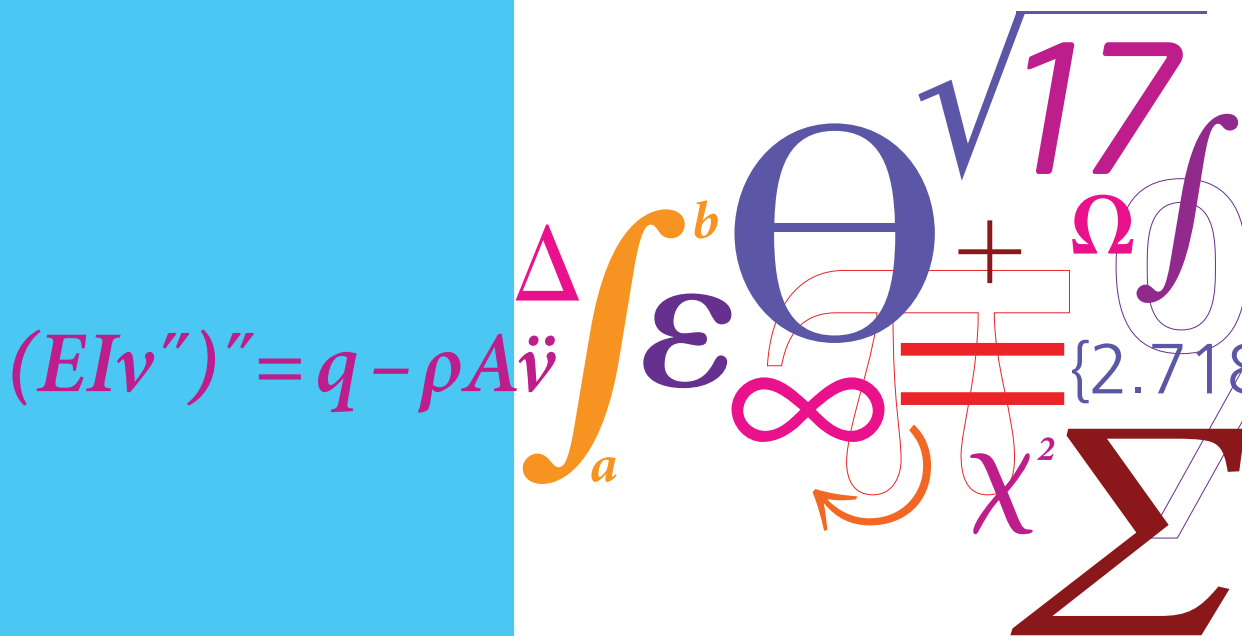

Fredrik Haglind
 Maria E. Mondejar
 Jesper G. Andreasen
 Leonardo Pierobon
 Andrea Meroni

Contents

Project summary	3
1 Introduction	4
1.1 Background	4
1.2 Objectives and deliverables of the project	5
1.3 Outline of the report	5
2 Onboard testing of the ORC unit	6
2.1 Assessment of condenser design	6
2.1.1 Printed circuit heat exchangers	6
2.1.2 Increase of the condenser pressure	7
2.2 Characteristics of the ORC power system	7
2.3 Measurement devices	7
2.4 Measurement results and model validation	9
2.5 Experiences gained from testing of the ORC unit	10
3 Potential of ORC power systems for WHR on ships	12
3.1 Evaluation of retrofitting potential	12
3.1.1 Case 1: Retrofit of ORC unit utilizing jacket water and lubrication oil heat	12
3.1.2 Case 2: Retrofit of ORC unit utilizing service steam	13
3.1.3 Case 3: ORC unit utilizing service steam on new-building	15
3.1.4 Economic analysis	15
3.1.5 Other case studies carried out in the project	17
3.2 Development of ORC unit models	19
3.3 Development of radial turbine model	20
3.4 Development of models for property prediction of new working fluids	20
3.5 Evaluation of working fluids for onboard ORC units	21
3.5.1 Low temperature ORC (jacket cooling water)	21
3.5.2 High temperature ORC (jacket cooling water and service steam)	22

4	Dissemination	23
4.1	Scientific journals	23
4.2	Conference contributions	23
4.3	Magazines	23
4.4	Multimedia	24
4.5	Project collaborations	24
4.6	Teaching	24
5	Conclusions	26
	References	28

Project summary

The project PilotORC was aimed at evaluating the technical and economic feasibility of the use of organic Rankine cycle (ORC) units to recover low-temperature waste heat sources (i.e. exhaust gases, scavenge air, engine cooling system, and lubricant oil system) on container vessels. The project included numerical simulations and experimental tests on a 125 kW demonstration ORC unit that utilizes the waste heat of the main engine cooling system on board one of Mærsk's container vessels.

During the design of the demonstration ORC unit, different alternatives for the condenser were analyzed in order to minimize the size of the heat exchanger area. Later on the ORC unit was successfully installed on board, and it has been working uninterruptedly since, demonstrating the maturity of the ORC technology for maritime applications. During the onboard testing, additional measuring devices were installed on the unit and experimental data at design and off-design conditions were collected.

Several simulation models were developed in order to evaluate alternative integrations of the ORC units with different sources and configurations. The developed models allowed for the study of different ORC configurations at design and off-design conditions, the simulation of radial-inflow turbines, and the prediction of thermophysical properties of alternative working fluids. The models for the ORC unit were validated with the collected experimental data.

The validated models were used to evaluate the retro-fitting potential of using ORC units for maritime applications, and the relevance of this technology for new-building projects. Firstly, an evaluation of the waste heat resources available on board Mærsk containers fleet, and an estimation of the potential energy recovery by means of the ORC technology was performed. The estimations showed that significant fuel savings can be achieved. It was found that integrating ORC units with the jacket cooling water within the service steam circuit could enable payback periods of approximately 5 years and high fuel savings. Conversely, if the heat from the exhaust gases was recovered, the total power production of the ORC unit could cover 10 % of the main engine power. Larger energy savings, 10 - 15 %, could be expected if advanced design methods are employed.

1 Introduction

This report summarizes the findings of the project entitled 'Organic Rankine cycle unit for waste heat recovery on ships (PilotORC)'. The project was running in the period from 1st September 2015 to 28th February 2017, and the partners of the project were Mærsk Line and DTU Mechanical Engineering. Den Danske Maritime Fond and Mærsk Line funded the project.

1.1 Background

Mærsk Line has a target of achieving 60 % lower CO_2 emissions per container moved by 2020, relative to 2007 reference standards. This target will have a significant impact for the container fleet, since it is estimated that about 30 % of the cumulative power is installed on container ships. Regarding the total emissions of container ships, more than 70 % relate to the main propulsion engine, while auxiliary engines and boilers account only for 9 % and 6 %, respectively, of the yearly CO_2 emissions. Therefore technologies to reduce the emissions of propulsion engines can have a significant impact on the achievement of the emissions targets.

Waste heat recovery (WHR) technologies are an effective solution to reduce fuel consumption and CO_2 emissions, and are already being used today in some vessels, converting up to 8 % of the main engine brake power to electric power. The scavenge air and the exhaust gases have high temperatures in the range of 150 to 300 °C and both account for shares of waste heat of approximately 29 % of the total waste energy¹. The jacket water and lubricating oil represent 25 % and 18 % of the share, respectively. These waste heat sources, which are otherwise expelled by the main engine, can be exploited for WHR with a promising potential.

The organic Rankine cycle (ORC) technology is used for grid and local power generation from low- to medium-temperature heat sources such as renewable energy (e.g. biomass, concentrated solar power, geothermal) or industrial waste heat. These systems have recently gained interest as a suitable technology for WHR systems on board ships. The main reasons for this are the ability of ORC units to recover heat at low and medium temperatures with acceptable efficiencies, and their expected lower payback periods in maritime applications (as a consequence of the higher cost of power generation on board vessels, compared to the average onshore power cost). While on-going research shows a potential for this technology on board vessels, there is a lack of essential know-how and experience about the utilization of low-temperature waste heat on ships, and the potential fuel savings and reductions of pollutant emissions that can be achieved.

¹Assuming cooling to 160 °C for the exhaust gases.

1.2 Objectives and deliverables of the project

The project PilotORC was aimed at evaluating the technical and economic feasibility of the use of ORC units to recover low-temperature waste heat sources on container vessels. The project included the development of models and numerical simulations, and their validation through experimental tests on a 125 kW demonstration ORC unit installed on board one of Mærsk's container vessels. The main objectives of the project were to evaluate the retro-fitting potential of using ORC units, and the maturity of this technology for maritime applications.

The deliverables of the project are enumerated as follows ²:

1. Evaluation of the testing of the pilot ORC unit (see section 2)
2. Proposal on how to tune the control system of the pilot ORC unit
3. Estimation of Mærsk line fleet overall saving potential (not included in this version of the report)
4. Evaluation and recommendations of retro-fitting potential (see section 3.1)
5. Proposal on design and integration of ORC units in new-buildings (see section 3.1)
6. A numerical model for the simulation of radial turbines (see section 3.3)

1.3 Outline of the report

This final report starts with a brief explanation of the background that motivated the project PilotORC in section 1, and states the objectives and deliverables of the project. The work related to the installation of the pilot ORC unit is described in section 2. The work included the assessment of the condenser design during the commissioning of the unit and the validation of numerical models using the measured data. Additionally, some general considerations for future ORC installations are provided based on the experiences gained during the testing. In section 3 the potential of fuel savings for three relevant ORC unit integration options is evaluated. An overview of the developed WHR system models is given in section 3.2. The development of a model for the simulation of radial expanders for ORC units is presented in section 3.3, and the evaluation of alternative working fluids for onboard ORC units is presented in section 3.5 [1]. Finally, the dissemination activities of the project are enumerated in section 4 and the main conclusions of the project are summarized in section 5.

²During the course of the project, deliverable 2 was canceled, and deliverable 6 was added (explanations for these modifications have been provided in progress reports or previous communication with Den Danske Maritime Fond).

2 Onboard testing of the ORC unit

The onboard testing of the demonstration ORC unit, corresponding to Deliverable 1, consisted in supporting the ORC unit installation, collecting operational performance data by installing additional measurement devices, and studying the off-design operation of the unit.

2.1 Assessment of condenser design

One general issue regarding utilization of low temperature heat for electricity production is the size of the system. In this regard, an evaluation of alternative designs to reduce the size of the heat transfer equipment was carried out prior to the installation of the ORC unit, in order to optimize the unit design. This evaluation was presented in an extensive report [2], and only a brief summary is given here.

Results from the simulation for the optimization of the condenser size were in line with the proposed design, with a relative error in the heat duty of about 10%. Besides splitting the condenser into two smaller units working in parallel, two alternative options to reduce the size of the condenser were explored: i) the use of printed circuit heat exchanger (instead of flat plate heat exchangers) given their high compactness, and ii) the increase of the condensing pressure from 0.21 MPa to 0.31 MPa. The results of these two measures are discussed below.

2.1.1 Printed circuit heat exchangers

Printed circuit heat exchangers (PCHE) consist of a stack of plates, through which the hot and cold fluids flow in a counter flow arrangement. The plates are equipped with a number of offset strip fins with the purpose of augmenting the surface area and attaining larger heat transfer area-to-volume ratios (i.e., high compactness). This technology is available on the market.

The simulations performed in order to evaluate the use of PCHE as an alternative solution to the condenser design showed that with this solution the required heat transfer area could be 5% lower compared to the one of the flat plate heat exchanger. Moreover, the pressure drops on the hot and cold sides were also lower. It was also pointed out that the present design allowed for a reduction of more than 50% of the total volume. The cost of this heat exchanger type was found to be competitive with flat plate heat exchangers.

2.1.2 Increase of the condenser pressure

The second option consisted in increasing the condensing pressure, thus allowing reducing the required heat transfer area. However, with this measure the overall energy conversion efficiency drops. The results of the simulations showed that the active plate length and the heat transfer area could be halved if the condensing pressure increased from 0.21MPa to 0.31MPa. However, the net power output would drop by more than 20 %, and therefore this solution would not be recommendable from a thermodynamic perspective.

2.2 Characteristics of the ORC power system

The main characteristics of the pilot ORC unit related to this project can be found in Table 2.2.

Table 1: Main characteristics of the installed pilot ORC unit.

Vessel	Arnold Mærsk
ORC unit manufacturer	Calnetix (Mitsubishi Heavy Industries)
Date of commissioning	April 2016
Nominal power	125 kW
Heat source (temperature)	Jacket cooling water (85°C)
Heat sink (temperature)	Seawater (15-22°C)

2.3 Measurement devices

The installed ORC unit included a series of measurement devices that are used to monitor and control the operation of the unit. Most of these devices were logged by a programmable logic controller (PLC), which could be easily accessed on the unit in order to extract the operational data. Only the available flow meters on the heat source and sink were not logged. However, the available measurements were not sufficient for the complete test of the unit, which motivated the onboard installation of additional measurement devices necessary for the posterior validation of the simulation models.

Figure 1 represents a schematic diagram of the ORC unit, where all the mentioned measurement devices are marked. The additional measurement devices that were installed during the testing of the unit consisted of 11 thermocouples, and an ultrasonic flow meter, that were connected to a logging device. The existing devices that were not logged by the main PLC were also connected to the logger during the testing. The thermocouples were used to measure the temperature of the working fluid, jacket cooling water, and seawater in different points of the installation. The ultrasonic flow meter was utilized to measure the working fluid mass flow rate, and to validate the measurements of the flow meters in the source and sink.

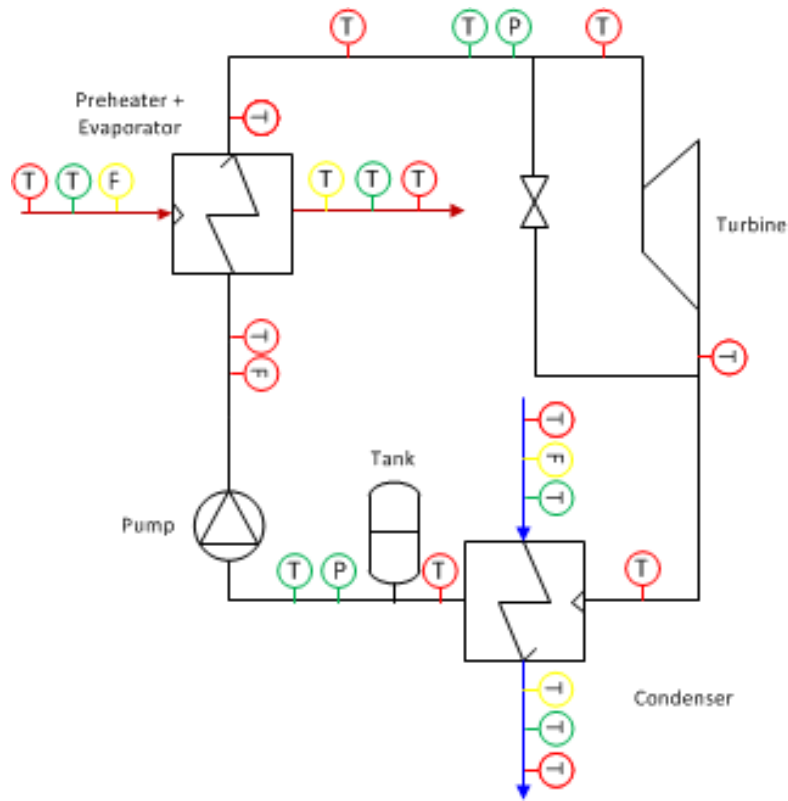

Figure 1: Schematic diagram of the ORC unit and the installed measuring devices. The measurement devices provided with the ORC unit and logged in the PLC are marked in green, while the measurement devices which are not logged are marked in yellow. The additional measurement devices that were installed during the onboard testing are marked in red.

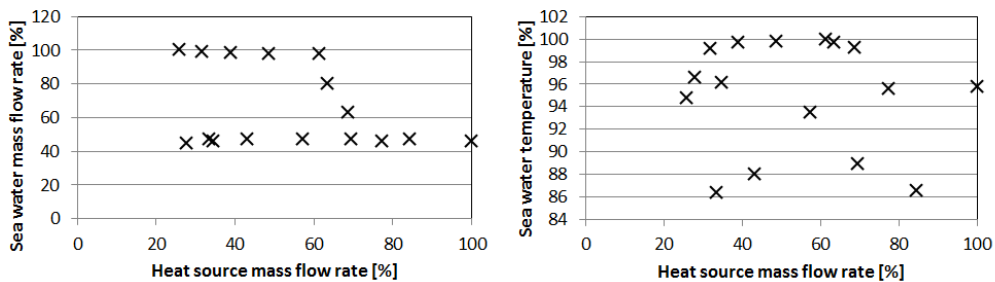

Figure 2: Ranges of the sea water mass flow rate and sea water temperature versus the heat source mass flow rate for the measured data.

2.4 Measurement results and model validation

The experimental data gathered for the pilot ORC unit was used to validate design and off-design models. An overview of the collected data is depicted in Figure 2. The heat source mass flow rate was varied by changing the power set point of the ORC unit and thereby controlling the hot water flow to the ORC unit. The sea water mass flow rate was varied by adjusting the rotational speed of the sea water pump. The sea water temperature varied according to the location of the ship.

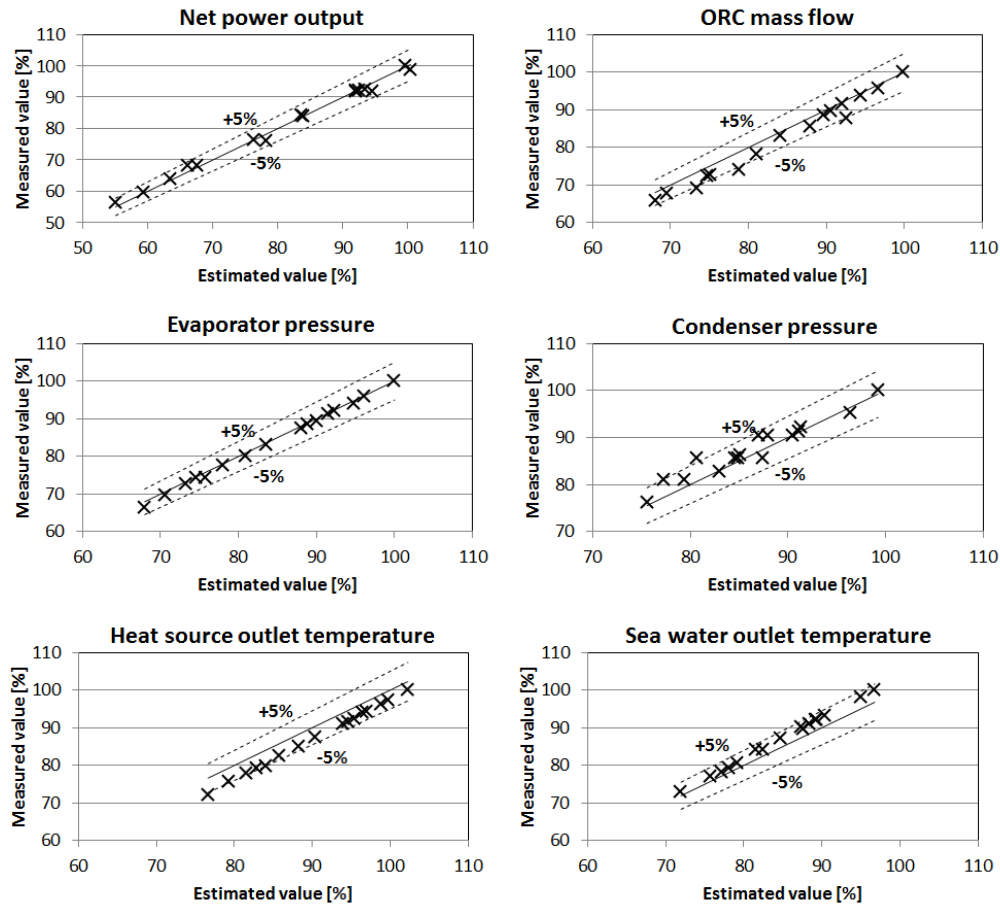

Figure 3: Validation of the numerical models based on the net power, ORC mass flow rate, evaporator pressure, condenser pressure, heat source outlet temperature, and sea water outlet temperature.

Figure 3 shows the results of the validation where the values of net power output, R245fa mass flow rate, evaporator pressure, condenser pressure, heat source outlet temperature, and sea water outlet temperature predicted by the numerical models are compared to measured values. The net power output is predicted with very good accuracy, within

± 5 %. For the ORC mass flow rate, evaporation and condensation pressures a few points are predicted with discrepancies above 5 %, however, the small absolute values of these properties tend to increase the relative deviations. The heat source outlet temperature and the sea water outlet temperature are over- and underpredicted, respectively, since the heat losses in the heat exchangers are not taken into account in the numerical models. The sea water outlet temperature is not a critical parameter, so a slight underprediction of this temperature is not an issue. For the heat source outlet temperature it is important to account for the additional heat (or temperature) loss due to heat transfer to the ambient when considering full scale implementation of ORC units for jacket water utilization. Not accounting for the heat losses from the evaporator, could result in a slight oversizing of the ORC unit. On the other hand, in full scale implementation of ORC units it is advantageous to insulate the evaporator to ensure maximum heat utilization. In case of insulated heat exchangers, it is expected that the numerical models estimates the heat source and sea water outlet temperatures with similar accuracies as the mass flow rate, evaporator and condenser pressures.

2.5 Experiences gained from testing of the ORC unit

In addition to the experimental data retrieved during the ORC unit tests, the following experiences were gained which are relevant for future ORC installations:

- ▷ For full scale integration of an ORC unit on the HT cooling water circuit, it is important to consider automatic regulation of the water flow to the ORC unit, the fresh water generator, and the LT cooling water circuit. In the current set-up, the only automatic valves are the ones governing the flow between the HT and LT cooling water circuits. The flows to the ORC unit and the fresh water generator are controlled by adjustment of manual valves. This works well for the current installation, since only a small part of the available heat in the HT water circuit is utilized, but for larger installations automatic valve regulation is desirable.
- ▷ Dynamic instabilities, likely induced by the pump speed control, were observed when operating the ORC unit at low power outputs. The first plot in Figure 4 shows how the power output of the ORC unit fluctuates even though the power set-point is constant. The second plot shows how the volume flow rate of R245fa fluctuates, while the third and fourth plot show fluctuations in the superheat degree and boiler pressure respectively. The net power output in Figure 4 is normalized using the power set point value, while the volume flow rate, superheat degree and boiler pressure are normalized using the average of the measured values in the depicted time span. The ORC unit controller is supposed to adjust the pump speed in order to maintain a constant superheat degree. However, the test results shows that it is incapable of this at low power outputs. In case the degree of

superheat reaches zero the unit must be shut-down to prevent damaging of the turbine blades due to liquid droplet formation at the turbine inlet. The current ORC unit operates primarily at power outputs close to the nominal value, but for larger installations low load operation will occur more often. It is therefore important to resolve the issues with the dynamic instabilities. Possibly, this can be done by tuning of the ORC unit control system.

- ▷ Insulation of the evaporator is relevant for larger installations, where all the available heat in the HT water circuit is utilized.
- ▷ Back-flushing of the condenser can be considered for easy cleaning of the heat transfer surfaces.

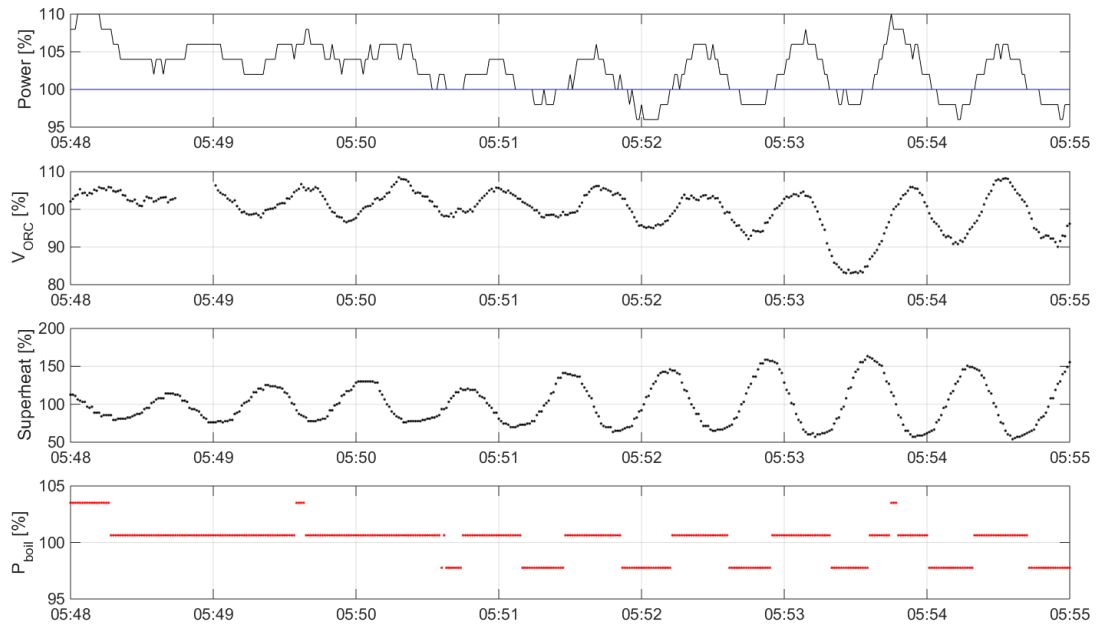

Figure 4: Dynamic instabilities observed on the net power output, the volume flow rate of working fluid, the superheating temperature, and the boiling pressure at low load operation.

3 Potential of ORC power systems for WHR on ships

In line with deliverables 3, 4 and 5, this section presents the performance estimations for three relevant ORC integration options. In the first case (case 1), the retrofitting of an ORC unit for utilization of jacket water and lubrication oil on a large container vessel with a 60 MW main engine was investigated. The installation of an ORC unit thereby enables the recovery of the low temperature heat sources which are challenging to exploit fully in conventional WHR systems due to their low temperature. In the second case (case 2), a full scale implementation of the unit was considered for a container vessel with an engine size around 65 MW. Instead of installing the ORC unit to utilize the jacket water heat only, the ORC unit was considered for installation in the service steam system, which would be redesigned to collect heat from the exhaust gases, scavenge air, and jacket water. In the third case (case 3), the installation of an ORC unit was considered for a new-building project with an engine size around 55 MW, where the engine tuning is selected in order to boost the WHR potential. The ORC unit installation on the service steam circuit was also considered for this case, since it represents a relevant option for a new ORC unit installation. The recovery potential of the ORC unit was compared to a state-of-the-art dual pressure SRC system.

The performance estimations were based on a design model which optimized the nominal power production for the ORC unit at a selected main engine load point (design point). Subsequently, the ORC unit performance was estimated at off-design conditions. All simulations were based on ISO ambient conditions. See Andreasen et al. [3] for details on the modeling procedure.

3.1 Evaluation of retrofitting potential

3.1.1 Case 1: Retrofit of ORC unit utilizing jacket water and lubrication oil heat

This retrofit case considered a scenario where the jacket water and lubrication oil heat is utilized in an ORC unit for electrical power generation. A sketch of the ORC system is shown in Figure 5 (left). The modeling conditions for the ORC unit are listed in Table 2. The ORC unit utilizes the same fluid as the demonstration ORC unit of this project (R245fa). The lubrication oil temperature was assumed to be above 50 °C at main engine loads above 25 %, and the heat demand for the fresh water generator was assumed to be 400 kW. The working fluid was therefore assumed to be heated to 50 °C at all loads (only loads above 25% were considered). The 400 kW of heat for the fresh water generator was subtracted from the jacket water heat.

The performance curves of the ORC unit, considering the design conditions at 100 %, 75 %, and 50 % main engine load, are shown in Figure 5 (right). When the engine operated at loads higher than the design point of the ORC unit, the power output was maintained at a constant value equal to the design point power. The design at 100 % main engine load enables power production up to 400 kW, while the design at 50 % load

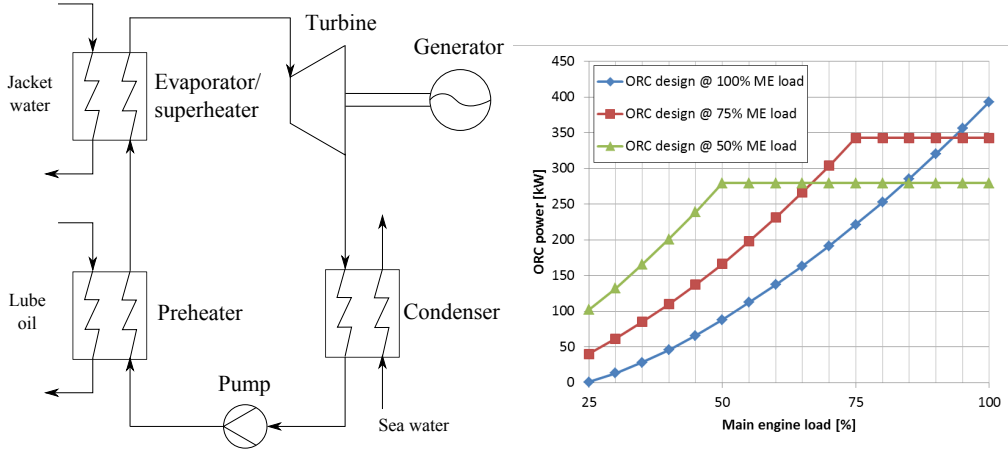

Figure 5: Sketch of ORC unit utilizing jacket water and lubrication oil (left) and ORC unit performance curve (right).

Table 2: Modeling conditions for ORC unit utilizing jacket water and lubrication oil.

Parameter	Value
Pump isentropic efficiency [%]	70
Turbine isentropic efficiency [%]	90
Boiler pinch point [°C]	5
Relative pressure drops in heat exchangers [%]	3
Generator efficiency [%]	93
Condensation temperature [°C]	35

enables the highest production at low engine loads.

3.1.2 Case 2: Retrofit of ORC unit utilizing service steam

This retrofit case considered a scenario where the service steam boiler is expanded to include feed water preheating with jacket water and scavenge air heat. Furthermore, the existing exhaust gas boiler is expanded by the installation of additional boiler tubes. A sketch of the steam circuit is depicted in Figure 6. The ORC unit layout is without recuperator corresponding to the layout of the demonstration unit. The modeling conditions for the ORC unit are listed in Table 3. The fluid used in this case was cyclopentane.

Figure 7 shows the total steam production from the exhaust gas boiler and the performance of two different ORC units designed at 50 % main engine load. In one case, the ORC unit utilizes all the steam (no service steam demand), while in the other case 2.4 t/h of service steam is assumed to be used for heating demands.

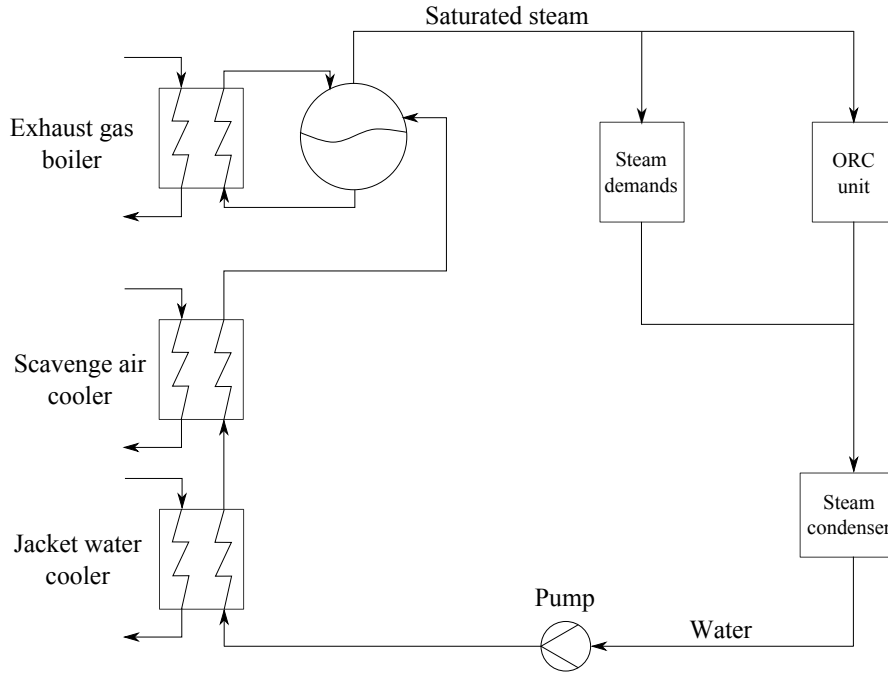

Figure 6: ORC unit integration in the service steam circuit.

Table 3: Modeling conditions for ORC unit utilizing service steam.

Parameter	Value
Steam circuit	
Heat capacity exhaust gases [kJ/(kg K)]	1.06
Heat capacity of scavenge air [kJ/(kg K)]	1.02
Steam pressure [bar]	7
Exhaust gas boiler feed water approach temperature difference [°C]	10
Exhaust gas boiler pinch point [°C]	20
ORC unit (cyclopentane)	
Pump isentropic efficiency [%]	70
Turbine isentropic efficiency [%]	90
Boiler pinch point [°C]	20
Relative pressure drops in heat exchangers [%]	3
Generator efficiency [%]	93
Condensation temperature [°C]	35

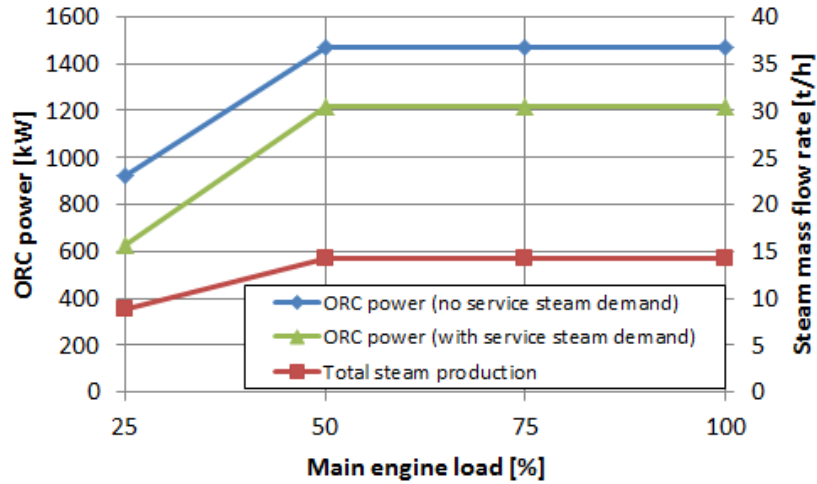

Figure 7: Steam mass flow rate and ORC unit power production.

3.1.3 Case 3: ORC unit utilizing service steam on new-building

This case considered a new-building scenario where an ORC unit is integrated in the service steam circuit. The sketch in Figure 6 and the modeling conditions in Table 3 apply again for this case. The ORC unit results were compared to the state-of-the-art dual pressure steam Rankine cycle (SRC). See Andreasen et al. [3] for details on the SRC unit. The two WHR units were considered for low pressure selective catalytic reduction (LP SCR) engine tuning, which enables high temperature exhaust gases.

The performance curves for the SRC and the ORC units are displayed in Figure 8. For both systems 2 t/h of service steam is extracted for heating purposes. The three curves for each of the WHR units indicate the influence of selecting the design point at either 100 %, 75 %, or 50 % main engine load. The net power outputs of the WHR units are largest at the design point, and in order to maximize the waste heat utilization the design point should be selected at a load point corresponding to typical operation of the engine. The performance curves illustrate that the SRC unit is able to recover more energy than the ORC unit, however, the ORC unit design is simpler, and does not include a low pressure boiler, a superheater, a turbine with multiple inlets, or a very low condenser pressure.

3.1.4 Economic analysis

The economic performance of the four WHR units (ORC units for case 1-3 and the SRC unit for case 3) presented above was estimated assuming that the electricity produced replaces four-stroke auxiliary engine production (fuel consumption: 210 g/kWh). The

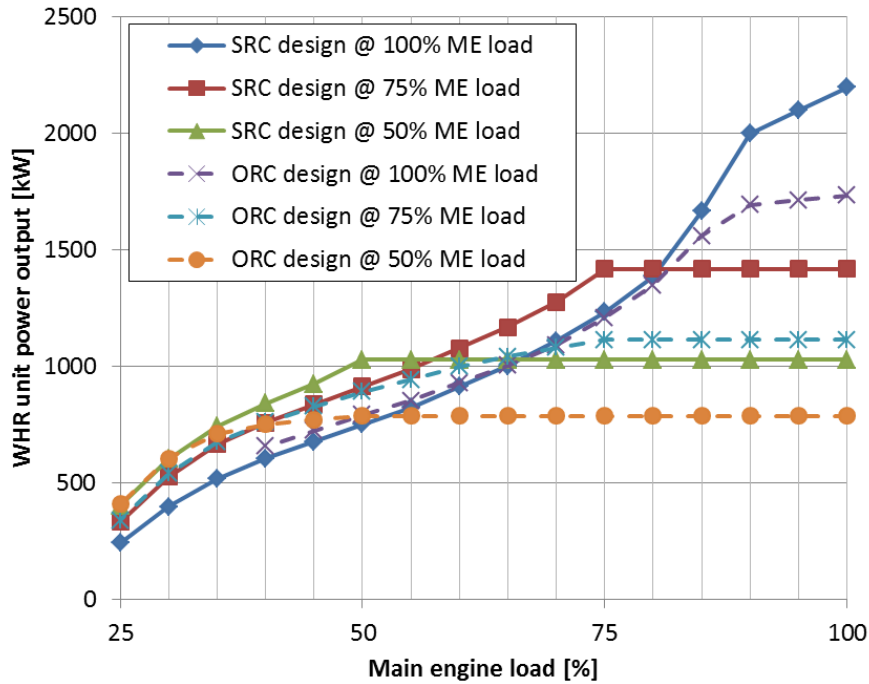

Figure 8: SRC and ORC unit power production for three different design points.

vessels were assumed to operate 6500 hours per year following the load profile shown in Figure 9. The selected design point for all four WHR units was at 50 % main engine load. This design point gives the best economic performance for the assumed main engine load profile. For the ORC unit in case 1 these assumptions resulted in an estimated annual electricity production of 1.5 GWh. The electricity production for the ORC unit considered in case 2 the electricity production was 6.9 GWh. In case 3 the ORC and SRC units enabled a yearly electricity production of 4.6 and 5.6 GWh respectively.

The payback periods of the four different WHR units are displayed in Figures 10 and 11 for varying fuel price and specific cost of installation. The specific prices of the ORC unit considered in case 1 are larger than the other cases due to the lower power production. Figure 12 shows a comparison of the payback period for the four WHR units with an assumed specific cost of 3000 \$/kW. At a fuel price of 300 \$/ton the payback periods are between 8 and 9 years, while at a fuel price of 500 \$/ton the payback periods are around 5 years. According to Quoilin et al. and [4] and Lemmens [5] the cost at 3000 \$/kW is representative of ORC units in the power range of 100 – 1000 kW used for WHR. For higher nominal power outputs the specific cost typically drops, while it increases at lower power outputs. The fuel prices of 300 \$/ton and 500 \$/ton correspond to current (spring 2017) prices for HFO and 0.1 % sulfur fuel respectively [6]. The lowest payback periods are obtained for the ORC units considered for installation in case 2 and 3. The SRC unit produces more power than the ORC units but the higher cost has a negative

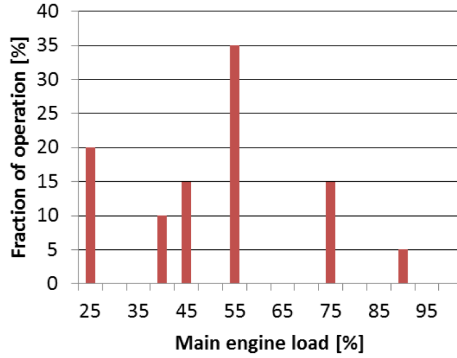

Figure 9: Assumed main engine load profile

effect on the payback period. The highest payback periods are reached for the ORC unit considered in case 1.

3.1.5 Other case studies carried out in the project

Besides the cases mentioned above the integration of ORC systems directly with the exhaust gases was also considered [3, 7]. A case study based on a 4500 TEU container vessel with a 23 MW WHR tuned engine, showed that the implementation of ORC technology compared to the state-of-the-art dual pressure SRC system enabled significant benefits, thanks to the higher performance at low load and the possibility of reaching higher turbine efficiency. In case the engine used a 3 wt% sulfur fuel the utilization of the exhaust gases was constrained due to a minimum boiler temperature limitation, in order to avoid acid corrosion, and high service steam demands. In this scenario an ORC unit using the working fluid MM reached the highest power outputs at low main engine loads, while the SRC system performed better at high engine loads. When the engine used a 0.5 wt% sulfur fuel, the minimum boiler temperature constraint was relaxed and the service steam demand reduced. This enabled the ORC unit using cyclopentane to reach higher performance than the SRC system for all engine loads. All WHR units experienced a significant improvement in performance when the sulfur content in the fuel was reduced. The ORC unit using MM increased the design point power by 33 %, while the design point power of the SRC system increased by 19 %.

In the review paper by Mondejar et al. [7], fuel savings of 10 % were estimated in case an ORC unit was installed to utilize the exhaust gases and jacket water from the 4500 TEU vessel considering an LP SCR tuned engine using a 0.1 wt% sulfur fuel. Even larger energy savings, 10 – 15 %, can be expected in case advanced design methods are employed, for example combined optimization of engine tuning and WHR system and optimization of WHR system performance considering the operational profile of the ship.

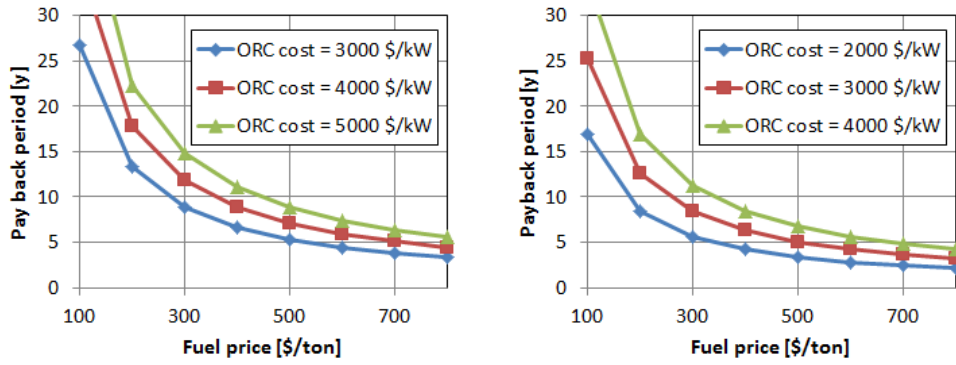

Figure 10: Payback period as a function of fuel price for the ORC unit from case 1 (left) and the ORC unit from case 2 (right).

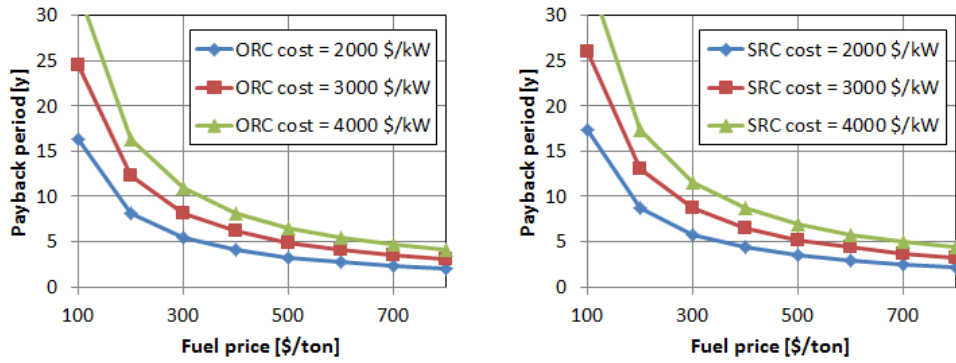

Figure 11: Payback period as a function of fuel price for the ORC (left) and SRC (right) units from case 3.

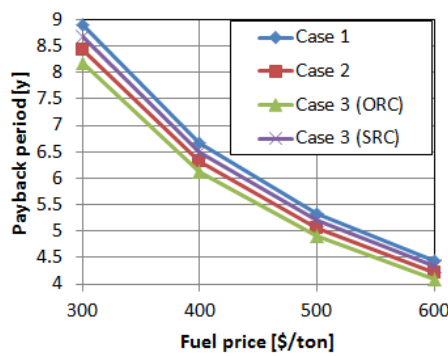

Figure 12: Comparison of payback periods for the four WHR units with specific cost of 3000 \$/kW.

3.2 Development of ORC unit models

During the project several models were developed for the prediction of ORC unit performance at design and off-design conditions for various heat sources [3]. These models were validated with the experimental data from the onboard testing of the demonstration unit. Models were also developed for state-of-the-art dual pressure steam Rankine cycle (SRC) units [3]. In case of exhaust gas utilization, the SRC unit models were used as a reference for which the ORC unit performance results were compared. The SRC unit models were validated with experimental sea trial data [3]. Most of the models were developed in Matlab. See Table 4 for an overview of the available options for selecting the type of WHR unit, the heat source and the control strategy. An Excel model was developed for the pilot ORC unit utilizing jacket water. The Excel model enables easy sharing of ORC models with industrial partners.

Table 4: Available options in Matlab models.

WHR system	Heat source	Control strategies (ORC only)
<ul style="list-style-type: none"> ▷ Simple ORC unit ▷ Recuperated ORC unit ▷ Dual pressure SRC unit ▷ Single pressure SRC unit 	<ul style="list-style-type: none"> ▷ Jacket water (HT cooling water) ▷ Scavenge air heat ▷ Exhaust gas ▷ Exhaust gas and preheating with jacket water ▷ Service steam 	<ul style="list-style-type: none"> ▷ Constant degree of superheat ▷ Constant degree of superheat + ORC unit bypass for controlling heat input ▷ Constant degree of superheat + boiler pressure control with throttle ▷ Constant boiler feed temperature ▷ Constant boiler feed temperature + boiler pressure control with throttle ▷ Constant turbine inlet temperature ▷ Constant heat source outlet temperature

3.3 Development of radial turbine model

State-of-the-art waste heat recovery systems aboard large ships employ turbo-expanders to achieve the best possible performance of the unit. Turbines with radial-flow configuration are used in turbochargers and power turbines and are a competitive technology in small-scale ORC power systems. These reasons brought to the development of a radial turbine numerical model that, thanks to its inherent versatility, can be used for the analysis and design of optimal waste heat recovery systems.

The model, named TURAD, resolves energy, mass, and momentum equations in order to provide temperature, pressure and velocity field at the different turbine stations (nozzle inlet/outlet, rotor inlet/outlet). TURAD was written in Matlab language and was based on a mean-line approximation, meaning that the balance equations are solved along the mean streamline of the flow. A publication presenting this model [8] will be submitted soon for publication in a scientific journal.

The model can run in two different modes: *analysis* and *design*. In the former, the user can specify turbine inlet total temperature, total pressure, pressure ratio, mass flow rate and other parameters related to flow and geometry conditions. TURAD yields thermodynamic conditions, velocity triangles, loss breakdown and turbine efficiency as output. In the *design* mode, the model is coupled to an external optimizer with the aim to determine the combination of input flow and geometric parameters that maximize the efficiency of the machine given the thermodynamic and flow conditions at the inlet.

TURAD employs a set of empirical loss correlations in order to estimate the losses in the different turbine parts (nozzle, vaneless space, rotor). These correlations have been validated over a wide range of turbines types and configurations from the literature.

The thermodynamic properties of the working fluid are computed by means of state-of-the-art equations of state (available in Refprop or CoolProp).

The model was validated against the data of the turbine described by McLallin and Haas (1980). The efficiency was predicted within 0.32 %-points of the experimental data.

3.4 Development of models for property prediction of new working fluids

In order to evaluate the potential of new alternative working fluids two models were developed for the prediction of the thermophysical behavior of halogenated olefins. Halogenated olefins are currently pointed out as the new generation of working fluids (see Section 3.5), but due to their novelty there is still a lack of knowledge about their behavior. The models were published in a high impact factor journal [9] (see section 4). Two new publications exploring the uncertainty of the prediction of the thermophysical behavior of these new working fluids [10], and their potential in ORC power systems [11], are now under preparation.

3.5 Evaluation of working fluids for onboard ORC units

The selection of the working fluid of organic Rankine cycle (ORC) power systems is essential for the optimization of their operation, and depends primarily on the operating temperatures and their capacity. New regulations targeting organic substances with undesirable environmental features have recently added on to the already strict criteria of flammability and toxicity hazards that ruled the choice of working fluid.

As a consequence, an assessment on working fluids for organic Rankine cycles on board vessels was carried out by DTU. The assessment report aimed to provide a concise view of the current panorama of working fluids. In this sense, the recent regulations were discussed, the market trends of working fluids price was evaluated, and alternative working fluids for ORC units, for both low and high temperature applications, were analyzed. This assessment was presented in an extensive report [1], and only a brief summary is given here.

Due to the recent amendment of the European F-gas regulation to the Montreal Protocol, the use of hydrofluorocarbons (HFCs) on ORC power systems will be restricted in a near future within the UN countries. This phase out of HFCs will increase dramatically their market price over the next few years, and will push industry towards the replacement of HFCs by new working fluids.

Under this context the availability of new working fluids for ORC units was evaluated from both thermodynamic and economic stand points, by using the developed tools described in section 3.2. The currently available replacements for HFCs can be classified into two groups: hydrofluoroolefins (HFOs) and natural refrigerants. These two options are briefly described as follows, depending on their suitability for the studied low and high temperature applications.

3.5.1 Low temperature ORC (jacket cooling water)

The potential working fluids for their use in ORC units operating at low temperatures (e.g., jacket cooling water) were presented as replacements of R245fa, which is a common HFC in use for ORC units and is being used in the demonstration unit on board Arnold Mærsk.

In the case of HFOs, R1234zeZ presented the best prospects for replacement, with the only inconvenience of a higher price of the working fluid. In the case of natural refrigerants, several hydrocarbons (e.g., cis-2-butene, neopentane) yielded similar operational conditions as those of R245fa, although precautions due to their high flammability need to be evaluated.

3.5.2 High temperature ORC (jacket cooling water and service steam)

The suitability of working fluids for high temperature applications is dominated by hydrocarbons, which have low prices but impose important safety constraints due to their high flammability. These considerations could increase the total installation cost, and therefore their economic viability should be carefully assessed by considering the additional safety costs. Siloxanes were also proposed as a feasible option for high temperature applications, since they have generally lower flammability, although the operating pressures could be significantly lower than those of hydrocarbons, which would require a re-design of the cycle components.

4 Dissemination

The results of this project were disseminated to both the scientific community and the industry by means of publications in high impact factor journals, contributions to conferences, and magazines of relevance in the shipping sector. These contributions are enumerated as follows.

4.1 Scientific journals

- ▷ Maria E. Mondejar, Stefano Cignitti, Jens Abildskov, John M. Woodley, Fredrik Haglind, Prediction of properties of new halogenated olefins using two group contribution approaches, *Fluid Phase Equilibria* 433 (2017), 79-96, (See [here](#)).
- ▷ J. G. Andreasen, A. Meroni, F. Haglind, A comparison of organic and steam Rankine cycle power systems for waste heat recovery on large ships. *Energies*, 10(4), 547 (2017), 1-23, (See [here](#)).
- ▷ M. E. Mondejar, J. G. Andreasen, L. Pierobon, U. Larsen, M. Thern, F. Haglind, A review on the use of organic Rankine cycle power systems on large ships. Submitted to *Renewable and Sustainable Energy Reviews*.
- ▷ C. Rechter, A. Meroni, G. Persico, F. Haglind, Evaluation of loss correlations for radial turbines operating with organic fluids. To be submitted to *Applied Energy*.
- ▷ M. E. Mondejar, S. Cignitti, J. Frutiger, J. Abildskov, G. Sin, J. M. Woodley, F. Haglind, Uncertainty on the prediction of the thermophysical behavior of new halogenated working fluids. Under preparation.
- ▷ M. E. Mondejar, S. Cignitti, J. Abildskov, J. M. Woodley, F. Haglind, Potential of new halogenated olefins as working fluids for organic Rankine cycles. Under preparation.

4.2 Conference contributions

- ▷ Pilot demonstration of a 110 kW organic Rankine cycle unit for marine engine waste heat recovery, Kick-off for Transport DTU, 1 June 2016. Poster.

4.3 Magazines

- ▷ Fragtskib producerer el af motorens spildvarme, DTU homepage (See [here](#)).
- ▷ Fragtskib producerer el af motorens spildvarme, re-published in *Teknisk Nyt* (See [here](#)).

- ▷ Nyt DTU-Mærsk-projekt med stort energi-sparepotentiale, Søfart.
- ▷ På vej til en grønnere skibsfart, Dynamo (magazine published by DTU, reaching many stakeholders in the Danish maritime industry) (See here, and here).
- ▷ På vej til en grønnere skibsfart, re-published in Maskinmesteren (See here).
- ▷ Mærsk-skib udnytter motorspildvarme, Maritime Danmark (See here).

4.4 Multimedia

- ▷ Project webpage: www.pilotorc.mek.dtu.dk.

4.5 Project collaborations

- ▷ Green Ship of the Future, Regional ECOFeeder project: (<http://greenship.org/project/regionalecofeeder>) Knowledge about ORC systems for maritime applications have been shared with industrial partners through participation in the ECOFeeder project. The numerical models developed in the project have been used to estimate the potential of installing ORC systems on the ECOfeeder [12].

4.6 Teaching

Results of the project have been disseminated to students at DTU through a course and projects. In the course "41422 Applied Engineering Thermodynamics" results of the project were communicated to the students when lecturing about the utilization of low-temperature heat sources for power generation.

Different advanced power cycles for the utilization of waste heat on ships were investigated in two Bachelor of Engineering student projects entitled "Low temperature waste heat recovery using absorption based power cycles" and "Co-generation of cooling and electricity from marine engine waste heat". A master thesis entitled "Development of a radial turbine model for small-scale organic Rankine cycle applications" aiming at developing a numerical model for the expander suited in the ORC unit installed on the vessel considered in the PilotORC project was carried out. A special course project entitled "Technologies for fuel consumption reduction onboard ships" assessed the applicability of fuel saving technologies (including ORC) for different ship types. Additionally, the ORC unit design and off-design models developed in the PilotORC project have been reused and extended in a master thesis entitled "Design and optimization of flexible ORC unit for waste heat recovery on board LNG-fuelled vessels".

Furthermore, up to now, the measuring equipment, which was funded by Den Danske Maritime Fond and used in the project by DTU for taking measurements on-board the vessel, has been re-used in the following projects: "Advanced Thermodynamic Methods

for Utilization of Industrial Energy Saving Potentials” (PhD project), ”Process Integration and Optimisation of Heat Recovery Loops” (master thesis project), ”Investigation of integrated operation of solar collectors, ground water heat pump and storage” (master thesis project), ”Energy analysis and optimization of processes in the metal industry” (master thesis project), and ”Modelling and optimization of heat transfer equipment in the dairy industry” (bachelor thesis project).

5 Conclusions

This final report presents the main activities carried out in the project PilotORC, and summarizes the main results and achievements. The project was aimed at evaluating the technical and economic feasibility of the use of organic Rankine cycle units for waste heat recovery on container vessels. The project included the development of simulation models and the experimental testing of a demonstration 125 kW ORC unit installed on board one of Mærsk's container vessels. The following main conclusions can be drawn from the realization of this project:

- ▷ The demonstration ORC unit was successfully installed on Arnold Mærsk, and has been in uninterrupted operation since April 2016. The testing of the unit, which consisted in the installation and logging of additional measurement devices and study of part-load operation, was completed. The test data was used to successfully validate numerical models of ORC units, which were subsequently used to estimate the potential of future ORC unit installations. Based on the operational experience gained during the testing, it was advised that automatic HT flow control, dynamic instabilities during low power operation, evaporator insulation, and back-flushing for condenser cleaning, are considered for possible future large scale ORC unit installations.
- ▷ A challenge on the design of ORC units for low temperature heat recovery is the size of the heat exchanger, in particular, the condenser. Besides splitting the condenser into two smaller condensers working in parallel, two alternative options were explored. The first, consisting in the use of printed circuit heat exchangers, offered a more compact condenser at a similar cost of that of standard plate heat exchangers. The second option, consisting in increasing the condensing pressure, was able to reduce the condenser size notably but it was not recommended because it reduces the net power production of the ORC unit.
- ▷ The estimations of the potential of installing ORC units for waste heat recovery showed that significant fuel savings can be achieved. For an ORC unit utilizing the jacket water and lubrication oil heat from a 60 MW engine the annual electricity production was estimated at 1.5 GWh. By integrating the ORC unit on an expanded version of the service steam circuit, the annual electricity production was estimated to be 6.9 GWh for a 65 MW engine (retrofit) and 4.6 GWh for a 55 MW engine (new-building with LP SCR tuned engine). Integrating ORC units in the service steam circuit represents a promising option for waste heat recovery enabling low payback periods (≈ 5 years for a 500 \$/t fuel price) and high fuel savings.
- ▷ In case the ORC unit is used to recover directly the heat from the exhaust gases, the unit is capable of higher fuel savings compared to the state-of-the-art dual pressure steam Rankine cycle. Generally, the ORC unit was found to be beneficial

compared to the dual pressure SRC system due to higher performance at low load and the possibility of reaching higher turbine efficiency. Especially, when a low-sulfur fuel is used, the potential of using WHR technology is large. When changing the sulfur content in the fuel from 3 wt% to 0.5 wt% the design power output of an ORC unit using the working fluid MM was estimated to increase by 33 %. The highest WHR potential was found in case a 0.1 wt% sulfur fuel was used in a LP SCR tuned engine. For such a scenario, the electricity produced by an ORC unit using cyclopentane as a working fluid was estimated to be around 10 % of the power production of the main engine. Considering further developments in ORC unit design techniques, for example combined engine tuning and WHR unit design, the electricity production could potentially be 10 – 15 % of the main engine power.

- ▷ A model for the design and analysis of radial-inflow turbines was developed in the Matlab language and it was validated considering a number of well-documented experimental test cases from the open literature. The numerical tool can be employed for a wide range of applications, including turbochargers and ORC power systems.
- ▷ An evaluation of alternative working fluids for ORC unit on board vessels was carried out. The recent regulations governing the phase out of working fluids with undesirable environmental features could reduce the availability of hydrofluorocarbons and increase their cost notably, thus affecting the overall viability of ORC units. The main alternative working fluids, hydrocarbons and hydrofluoroolefins, would require a re-evaluation of the ORC unit viability due to their high flammability, or high price, respectively. However, both alternatives could be good options for retrofitting, as almost no cycle modifications would be needed.

References

- [1] M. E. Mondejar, J. G. Andreasen, F. Haglind, Assessment of working fluids for organic rankine cycle power systems.
- [2] L. Pierobon, M. E. Mondejar, J. G. Andreasen, F. Haglind, Integration of the ORC pilot unit onboard Axel Mærsk: Condenser sizing and integration.
- [3] J. G. Andreasen, A. Meroni, F. Haglind, A comparison of organic and steam Rankine cycle power systems for waste heat recovery on large ships, *Energies* 10(4),547 (2017) 1–23.
- [4] S. Quoilin, M. V. D. Broek, S. Declaye, P. Dewallef, V. Lemort, Techno-economic survey of Organic Rankine Cycle (ORC) systems, *Renewable and Sustainable Energy Reviews* 22 (2013) 168–186.
- [5] S. Lemmens, Cost engineering techniques and their applicability for cost estimation of organic Rankine cycle systems, *Energies* 9 (7).
- [6] Platts, McGraw Hill Financial, www.bunkerworld.com/prices/, [accessed: 06/08/2015].
- [7] M. Mondejar, J. G. Andreasen, L. Pierobon, U. Larsen, M. Thern, F. Haglind, A review on the use of organic Rankine cycle power systems on large ships, Submitted to *Renewable and Sustainable Energy Reviews*.
- [8] C. Rechter, A. Meroni, G. Persico, F. Haglind, Evaluation of loss correlations for radial turbines operating with organic fluids, To be submitted to *Applied Energy*.
- [9] M. E. Mondejar, S. Cignitti, J. Abildskov, J. M. Woodley, F. Haglind, Prediction of properties of new halogenated olefins using two group contribution approaches, *Fluid Phase Equilibria* 433 (2017) 79–96.
- [10] M. E. Mondejar, S. Cignitti, J. Frutiger, J. Abildskov, G. Sin, J. M. Woodley, F. Haglind, Uncertainty on the prediction of the thermophysical behavior of new halogenated working fluids, Under preparation.
- [11] M. E. Mondejar, S. Cignitti, J. Abildskov, J. M. Woodley, F. Haglind, Potential of new halogenated olefins as working fluids for organic rankine cycles, Under preparation.
- [12] 2,500 TEU Regional ECOFeeder, Green Ship of the Future.

DTU Mechanical Engineering
Department of Mechanical Engineering
Technical University of Denmark

Nils Koppels Allé, Bld. 403
DK- 2800 Kgs. Lyngby
Denmark
Tlf. (+45) 4525 4131
(+45) 4588 4325

www.mek.dtu.dk