



Supporting power balance in Microgrids with Uncertain Production using Electric Vehicles and Indirect Control

Banis, Frederik; Guericke, Daniela; Madsen, Henrik; Poulsen, Niels Kjølstad

Published in:
IFAC-PapersOnLine

Link to article, DOI:
[10.1016/j.ifacol.2019.08.238](https://doi.org/10.1016/j.ifacol.2019.08.238)

Publication date:
2019

Document Version
Peer reviewed version

[Link back to DTU Orbit](#)

Citation (APA):
Banis, F., Guericke, D., Madsen, H., & Poulsen, N. K. (2019). Supporting power balance in Microgrids with Uncertain Production using Electric Vehicles and Indirect Control. *IFAC-PapersOnLine*, 52(4), 371-376. <https://doi.org/10.1016/j.ifacol.2019.08.238>

General rights

Copyright and moral rights for the publications made accessible in the public portal are retained by the authors and/or other copyright owners and it is a condition of accessing publications that users recognise and abide by the legal requirements associated with these rights.

- Users may download and print one copy of any publication from the public portal for the purpose of private study or research.
- You may not further distribute the material or use it for any profit-making activity or commercial gain
- You may freely distribute the URL identifying the publication in the public portal

If you believe that this document breaches copyright please contact us providing details, and we will remove access to the work immediately and investigate your claim.

Supporting power balance in Microgrids with Uncertain Production using Electric Vehicles and Indirect Control^{*}

Frederik Banis, Daniela Guericke, Henrik Madsen, Niels Kjølstad Poulsen^{*}

^{*} DTU Compute, Technical University of Denmark

Abstract: In Microgrids with uncertain production storages are valuable assets to facilitate system stabilization. Consequently, electric vehicles (*EVs*) are promising for providing prosumer services. EVs are assets driven by human behavior, consequently they can rarely be directly controlled. However, indirect control approaches are considered promising regarding their integration into system controls. In this paper we consider a hierarchy of optimized system controls including indirect control approaches in order to leverage flexibility potential associated with EVs.

Keywords: Predictive Control, Indirectly Controlled Systems, Electric Vehicles

1. INTRODUCTION

Small grid compartments referred to as Microgrids (MGs) combined with higher shares of Renewable Energy Sources (RES) require sufficient operational flexibility when aiming for the participation in energy markets. Energy market participation can be achieved when considering aggregation of Distributed Energy Resources (DER) by the *Aggregator* entity Morales et al. (2014). Failure to meet accepted market commitments lead to the application of penalties; accordingly, avoiding such costs is beneficial from the Aggregator perspective.

Storage capacities acting as Prosumers offer degrees of freedom and are therefore valuable assets in the operational scheme. We hereby consider Electric Vehicles (EVs) as uncertain storage capacities. In order to leverage flexibility in conjunction with EVs, Indirect Control (IC) enables MG-controller to activate this flexibility by means of economical incentives. Doing so is advantageous in terms of applicability, due to that Direct Control (DC) requires bi-directional communication and reduces flexibility for the EV owner compared to IC Madsen et al. (2014). IC however is associated with drawbacks such that the response of the activated prosumer side is both uncertain by means of dynamics and magnitude Olivier Corradi and Henning Ochsensfeld (2011). The introduction of appropriate models that enable the estimation of the consumptive response behavior is therefore central to the IC approach.

In related publications game theory based approaches are often considered. An example is Nwulu and Xia (2017). This paper considers an optimal control theory based approach. Similarly as to outlined in Liu and Yu (2016), we consider a charging behavior model throughout this paper. In contrast to this publication, we do not emphasize the derivation of a proper model but focus on the control hierarchy and data management. A more technical approach

to the topic can be found in Flocha et al. (2016). Both Salinas et al. (2013) and Jin et al. (2017) examine multi-objective approaches. Knudsen and Rotger-Griful (2015) utilize a two-stage Model Predictive Control (MPC) approach combining two demand-response (DR) schemes: event-based DR and price-based DR. They however focus on slower dynamics and hourly sampling rate of the controllers.

In this paper we focus on activation of the EVs in times of critical operating situations. We consider this in the context of a control hierarchy composed of a planning problem and real-time control problem. We focus on the real-time problem including a re-dispatch layer, adaptive disturbance rejection controller and an indirect controller. We implement a temporal clustering approach of estimated price-sensitivity models which allow for the ongoing improvement of model accuracy and consideration of temporal variability of the system.

The rest of the paper is organized as follows. Section 2 introduces the considered control structure and indirect control approach. In section 3 we present numerical results. We close with section 4 discussing the findings and future improvements.

2. METHODOLOGY

We consider the structure of optimization routines and controllers as depicted in fig. 1 on the following page. These layers constitute the Microgrid controller, see fig. 2 on the next page.

The EMS derives a dispatch schedule considering the largest share of information available to the MG-controller. The solution to this problem is used by the Aggregator entity to derive bids into markets. When bids are accepted the agreed quantities are binding and results in a commitment of the aggregator and its actor, the MG. Disability to fulfill the commitment lead to application of penalties.

^{*} This work has been supported by *ENERGINET.DK* under the project microgrid positioning - *uGrip* and the *CITIES* project.

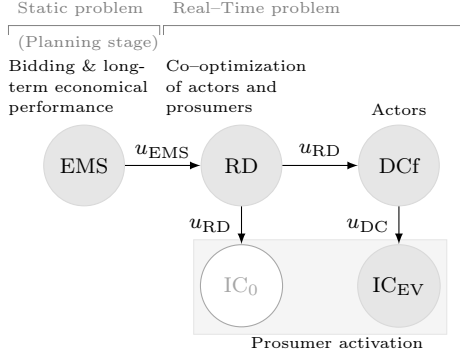

Fig. 1. Dataflow overview: Optimal input sequence u_{EMS} (Energy Management System) is passed to the real-time control routines: The re-dispatch co-optimizes both directly and indirectly controllable units. The solution u_{RD} is passed to Direct Control and Indirect Control routines.

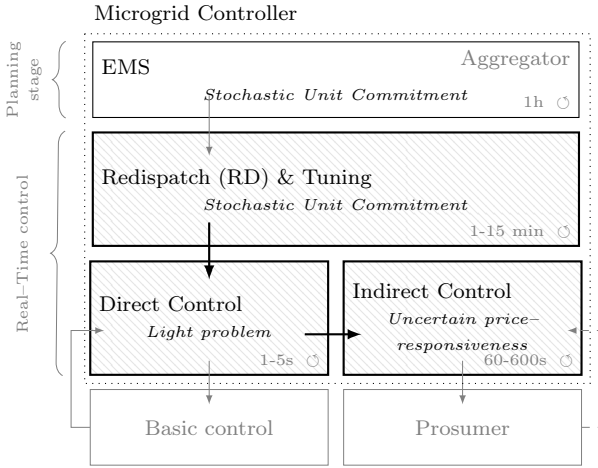

Fig. 2. Control hierarchy. We focus on the highlighted control routines. The Re-dispatch problem derives economically optimal input sequences taking the estimated price-sensitivity of the EVs for the currently active cluster into account.

Consequently, the solution u_{EMS} is treated as reference in subsequent layers in the control hierarchy.

During real-time optimization of an MG with considerable share of Renewable Energy Sources we are faced with the need to properly incorporate predictions with sufficient temporal window as well as providing well-informed decisions. These have to be derived with a chosen sampling rate such that we compensate for disturbances sufficiently well. These requirements result in the splitting of the real-time optimization routines by sampling rate in fast routines and slow routines. The slow routines encompass the re-dispatch (RD) layer and the Indirect Control (IC) layer; both layers are sampled considerably slower compared to the Direct Control (DC) layer. Sampling rates are hereby determined given the considered system dynamics and disturbance characteristics.

As DC control problem example we choose in this paper frequency stabilization, this layer is sampled in the magnitude of a few seconds — depending on the system dynamics and disturbance characteristics.

Energy Management System (EMS) is formulated as Stochastic Program (SP) and consequently treats uncertainty using a scenario based approach. It derives optimal bids to various electricity markets and derives a dispatch schedule for the next 24 hours ahead of time. As stochastic processes we consider uncertain production quantities, uncertain consumption quantities and market prices. See Section 2.1.

Re-dispatch (RD) derives control decisions based on real-time operational requirements, considering economical measures and/or risk based measures. See Section 2.2.

Direct Control (DC) we consider applicable for fast dynamics Madsen et al. (2014), such as frequency stabilization. See Section 2.3.

Indirect Control (IC) we consider for the activation of flexibility in the Microgrid (MG) using economical incentives. See Section 2.4.

2.1 Energy Management System layer

The Energy Management System is not focus of this paper, for thoroughness we introduce this layer briefly below.

As first stage decisions we consider market bids into:

- Day-ahead (DA) market
- Real-Time (RT) market

As second stage decisions we consider scenarios of uncertain processes and the following variables:

- Generated power by conventional generators
- Curtailment of RES
- Storage charging/ discharging

This optimization problem then takes the general form of a two stage stochastic problem—or stochastic unit commitment problem—see Conejo et al. (2010); Pandzic et al. (2016):

$$\min_u c^T u + \sum_{\omega \in \Omega} \pi(\omega) q(\omega)^T y(\omega) \quad (1a)$$

$$\text{s.t. } Au = b \quad (1b)$$

$$T(\omega)u + W(\omega)y(\omega) = h(\omega) \quad \forall \omega \in \Omega \quad (1c)$$

$$u \geq 0 \quad (1d)$$

$$y(\omega) \geq 0 \quad \forall \omega \in \Omega \quad (1e)$$

The solution to this problem u is then denoted as u_{EMS} and passed as reference to the RD layer.

2.2 Re-Dispatch layer

The re-dispatch layer can be formulated in various ways; simplified we can state it with a focus either on economical optimality or robustness in the chosen decisions. The latter may be more important when dealing with a system in islanded operation and limited degrees of freedom in the decisions.

We consider a predictive economic re-dispatch with respect to active power balancing where we take both certain system units and uncertain system units into account. Hereby two cases are relevant, depending on whether a

system identification event (sys-id) is currently carried out:

- Parametric case (sys-id): The input to the indirectly controllable units \tilde{u} is fixed and enters the objective as parameter. Consequently only the input to the directly controllable units \bar{u} is available as degree of freedom.
- Co-optimized case (no sys-id): Both directly controllable unit input \bar{u} and indirectly controllable unit input \tilde{u} are available as degrees of freedom.

$$\min_{\hat{x}, u, \hat{y}} \sum_{k \in \mathcal{N}} c_{u,k} u_k + \rho_v v_k \quad (2a)$$

$$\text{s.t. } \hat{x}_{k+1} = A\hat{x}_k + Bu_k + G\hat{d}_k \quad (2b)$$

$$\hat{y}_k = C\hat{x}_k \quad (2c)$$

$$u_{\min} \leq u_k \leq u_{\max} \quad (2d)$$

$$\Delta u_{\min} \leq \Delta u_k \leq \Delta u_{\max} \quad (2e)$$

$$\hat{y}_{k,\min} \leq \hat{y}_k + v_k \quad (2f)$$

$$\hat{y}_{k,\max} \geq \hat{y}_k - v_k \quad (2g)$$

$$v_k \geq 0 \quad (2h)$$

$$G_{\parallel} u_k \leq h_{\parallel} \quad (2i)$$

The slack associated costs ρ_v hereby have to be dynamically determined or estimated. ρ_v are marginal costs of one unit of upper output reference (\hat{y}_{\max}) and lower output reference (\hat{y}_{\min}) violation. The disturbance vector \hat{d} contains the lumped active power disturbance estimate \hat{d}_0 which is derived at the ADRC layer using an extended state observer (ESO). \hat{d}_0 is assumed to be currently valid at call-time of the solver. The remaining disturbance terms are assumed to be provided by forecasting services.

The constraints equation (2i) include additional operative system equations.

The solution to this problem is then denoted as u_{RD} and passed as reference to both the ADRC and IC layer.

Co-optimization case c_u are hereby operative unit costs with respect to both price-insensitive and price-sensitive units:

$$c_u = [\tilde{c}_u \ \bar{c}_u] \quad (3)$$

Due to that the price-sensitive unit-response is uncertain, the corresponding unit cost \tilde{c}_u is uncertain. Equation (2i) in this case also contains the estimated operational requirements of the price-sensitive units.

2.3 Direct Control layer

We consider a classical quadratic regulation objective with input reference tracking. Using an Extended State Observer (ESO) the unknown residual d is estimated yielding the estimate \hat{d} . We account for it using an input disturbance model as outlined in Pannocchia and Rawlings (2003) — the controller in this form is often in literature referred to as Active Disturbance Rejection Controller (ADRC). The quadratic regulatory problem with input reference tracking term is then formulated as:

$$\min_{u, k} \|\hat{y} - \bar{y}\|_{W_y}^2 + (1 - \gamma) \|u_k - u_{\text{RD},k}\|_{W_u}^2 \quad (4)$$

$$\text{s.t. } \hat{x}_{k+1} = A\hat{x}_k + Bu_k + G\hat{d}_k \quad (5)$$

$$\hat{y}_k = C\hat{x}_k \quad (6)$$

$$u_{\min} \leq u_k \leq u_{\max} \quad (7)$$

$$\Delta u_{\min} \leq \Delta u_k \leq \Delta u_{\max} \quad (8)$$

$$G_k u_k \leq h_k \quad (9)$$

We consider the input reference sequence u_{RD} from the re-dispatch layer. This regulator formulation given sufficient degrees of freedom stabilizes system frequency whilst minimizing the deviation from the reference u_{RD} . Lack of freedom in both absolute controllable production capacity and available up-ramp or down-ramp results in system frequency deviations. Notice that we neglect a dedicated regularization term acting in the objective when $\gamma = 1$; this is due to that we rely on the ESO as means to smooth the control actions.

Frequency stabilization is a control problem potentially exhibiting fast dynamics — this is especially true when accounting for high penetration of RES. This problem consequently is required to be solved in real-time with sufficient sampling rates, consequently it has to remain light. The prediction horizon we account for at this level in the hierarchy is therefore limited, allowing for only limited inclusion of predictions.

An alternative regulation formulation can be found in Banis et al. (2018).

2.4 Indirect Control and System Identification layer

We adopt the economic Indirect Control objective as formulated in Olivier Corradi and Henning Ochsensfeld (2011):

$$\min_p \mathbb{E} \left[\sum_{k=0}^N \|\hat{z}_k - \bar{z}_k\|_w + \|p_k - \bar{p}_k\|_{\mu} \right] \quad (10a)$$

$$\text{s.t. } \hat{z}_{k+1} = f_c(p_k) \quad (10b)$$

$$\bar{z}_k = s(u_{\text{RD}}^*) \quad (10c)$$

$$w + \mu = 1 \quad (10d)$$

The estimated price sensitivity f_c in the currently active cluster c is hereby:

$$f_c(p_k) = \tilde{b}_c + \sum_{i=k}^N \tilde{H}_{c,i} p_k \quad (11)$$

f_c maps the price offer p_k to the estimated uncertain response. \tilde{b}_c denotes the uncertain baseline interaction, \tilde{H}_c denote the uncertain impulse response coefficients. Time-varying models can be estimated using for example an auto-regressive model with exogenous input (ARX) structure. Uncertainty is then approximated by aggregation and evaluation of model parameters in chosen temporal clusters. See Figure 3 as example. We chose daily meta clusters with hourly granularity in consecutive clusters in which we aggregate identified system response models, see fig. 4 on the following page.

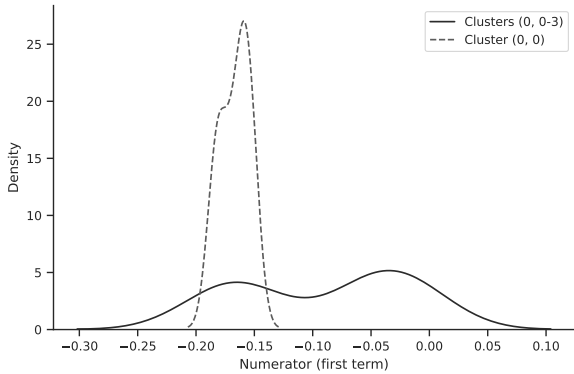

Fig. 3. Parameter density example: Choice of confidence interval allows for deriving uncertainty estimates for system operation.

Note that equation (11) on the previous page is the estimated uncertain response model available to the MG controller. See also Figure 6 as example.

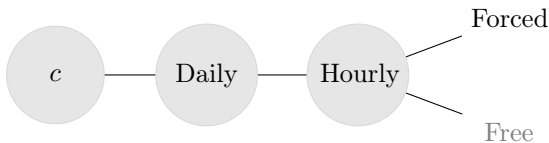

Fig. 4. Assumed sensitivity function clusters (highlighted). The free system trajectory is recorded for control and evaluation purposes.

System Identification We perform the system identification (ID) event conditionally whenever a price step is sent to the sensitive units exceeding a chosen threshold $\tau_{0,ID}$. This ID event is maintained until a chosen time $\tau_{1,ID}$ has passed. This latter time constant has to be large enough to allow for price-sensitive units to respond and settle according to the step in price. Due to this requirement of a constant price during the identification event, the re-dispatch layer is operated in parametric operation case throughout this period.

We limit the amount of considered models in each cluster — this introduces adaptive properties of the approach such that altered operating conditions are accounted for.

When maintaining the cluster size we can remove model parameters either biased or unbiased, the latter of which is often referred to as randomized forgetting. We choose a biased approach, in which the chosen cluster size is maintained by removing parameters with largest excursion with respect to the median once the cluster size is exceeded. This lead to a higher confidence in the uncertain system response due to that system responses that deviate the most from the median response are removed. See also Figure 7 as example for a case with substantial uncertainty in the estimated response.

3. NUMERICAL RESULTS

We consider a microgrid with one fully controllable unit modeled as first order linear time invariant system.

The load side includes 30 electrical vehicles (EVs) with an assumed individual nominal charge power of $3.6 \pm .05$ kW and individual charge capacity of $24.2 \pm .05$ kWh. The nominal consumption is assumed 216 kW, the EVs consequently account for half the overall nominal grid power. The active power interaction dynamics $f_{P,n}$ of each EV n are assumed as first order system with a time constant of $\tau = 180 \pm .05$ s. $f_{P,n}$ hereby maps the individual EVs active power grid interaction reference to the actual units active power grid interaction response.

In non-excited mode (price offer $p = 0$) the EVs expose the internal charge pattern over 24 hours and 7 days as illustrated in Figure 5: The highest overall State of Charge is in this example reached in the early morning hours whilst the lowest State of Charge is reached in the afternoon.

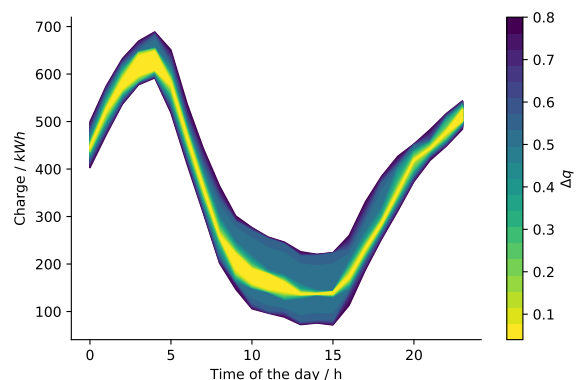

Fig. 5. Assumed aggregated internal State of Charge of all simulated EVs throughout a day considering 24 hours over 5 days. Δq hereby denotes the quantile range around median.

STARTED Consumer side price response The price mapping function equation (12) depicts the aggregated reduction in demand for a given price. This is a relationship chosen by the price-sensitive EV controllers. We assume a linear relationship with saturated bounds as load flexibility response in steady state, following the approach outlined in Halvgaard et al. (2013).

$$f_c(p) = -\frac{\bar{r}_c - \underline{r}_c}{\bar{p}_c - \underline{p}_c}(p - \underline{p}) + \bar{r}_c \quad (12)$$

The rebound effect hereby remains unaccounted for.

We test the identification pipeline in both one single cluster (0, 0) (corresponding to 12pm, day -1) and considering multiple clusters (0, 0-23) (corresponding to 12pm, day -1 until 23pm, day 0). See Figure 6 and Figure 7 respectively. As expected, the uncertainty is considerable when observing multiple clusters, supporting the approach of temporal clustering taking a baseline behavioral model into account.

STARTED Flexibility support We examine the utilization of the EVs to support power balance in a situation where an increased need for system flexibility can be anticipated by the Re-Dispatch layer. We assume this can be achieved, for example by observing previous system

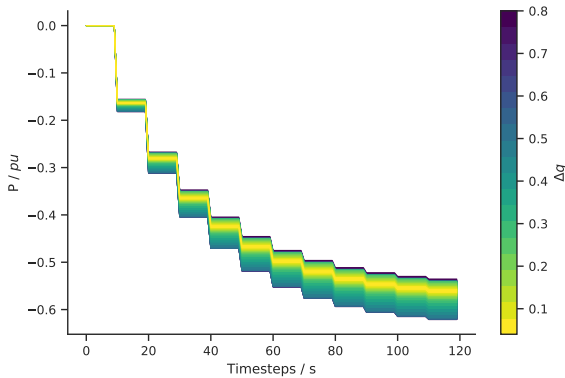

Fig. 6. Aggregated response when considering one cluster (here: cluster 0, 0).

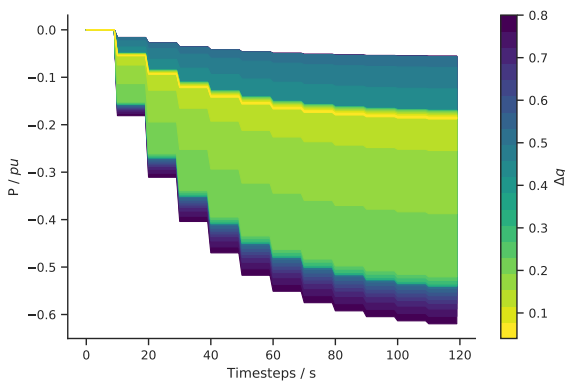

Fig. 7. Aggregated response when considering multiple clusters, here all hourly clusters of day 0.

behavior such as illustrated in Figure 5.

In this test case the available EVs can be activated such that the disturbance is to some degree compensated for, see Figure 9. In this example we compare the overall system response to this situation in the case where only Direct Control (DC) is available and in the case where both DC and Indirect Control (IC) are available.

In Figure 9 we simulate charge interaction changes. In this case the price signal is used to reduce the impact of steps in the disturbances.

4. DISCUSSION AND CONCLUSION

We aim to utilize a hierarchy of controllers with demand response activation capabilities to improve real-time system objectives such as frequency stabilization. Using online system identification techniques and model aggregation in temporal clusters we work towards inclusion for the temporal variability and uncertainty of a group of electric vehicles which are subject to a modeled stochastic behavior. Using biased forgetting with selected cluster sizes we improve model accuracy such that time-varying behavior in reoccurring clusters can be accounted for. Simulations show the potential of using price-sensitive system components with potentially fast dynamics such as EVs to support operational system objectives.

REFERENCES

- Banis, F., Guericke, D., Madsen, H., and Poulsen, N.K. (2018). Utilizing flexibility in Microgrids using Model Predictive Control. In *MedPower 2018*. Croatia.
- Conejo, A.J., Carrión, M., and Morales, J.M. (2010). Stochastic Programming Fundamentals. In *Decision Making Under Uncertainty in Electricity Markets*, International Series in Operations Research & Management Science, 27–62. Springer, Boston, MA.
- Flocha, C.L., Bellettib, F., Saxenac, S., Bayena, R.M., and Mouraa, S. (2016). Distributed Optimal Charging of Electric Vehicles for Demand Response and Load Shaping. In *54th IEEE Conference on Decision and Control, CDC 2015*, 7403254. doi: <https://doi.org/10.1109/CDC.2015.7403254>.
- Halvgaard, R., Poulsen, N.K., Madsen, H., and Jørgensen, J.B. (2013). Thermal storage power balancing with model predictive control. In *Control Conference (ECC), 2013 European*, 2567–2572. IEEE.
- Jin, M., Feng, W., Liu, P., Marnay, C., and Spanos, C. (2017). MOD-DR: Microgrid optimal dispatch with demand response. *Applied Energy*, 187, 758–776. doi: 10.1016/j.apenergy.2016.11.093.
- Knudsen, M.D. and Rotger-Griful, S. (2015). Combined price and event-based demand response using two-stage model predictive control. In *Smart Grid Communications (SmartGridComm), 2015 IEEE International Conference On*, 344–349. IEEE.
- Liu, P. and Yu, J. (2016). Charging behavior characteristic simulation of plug-in electric vehicles for demand response. In *2016 UKACC 11th International Conference on Control (CONTROL)*, 1–6. doi: 10.1109/CONTROL.2016.7737632.
- Madsen, H., Parvizi, J., Halvgaard, R., Sokoler, L.E., Jørgensen, J.B., Hansen, L.H., and Hilger, K.B. (2014). Control of Electricity Loads in Future Electric Energy Systems. *Handbook of Clean Energy Systems*, 6, 63.
- Morales, J.M., Conejo, A.J., Madsen, H., Pinson, P., and Zugno, M. (2014). *Integrating Renewables in Electricity Markets*, volume 205 of *International Series in Operations Research & Management Science*. Springer US, Boston, MA. doi:10.1007/978-1-4614-9411-9.
- Nwulu, N.I. and Xia, X. (2017). Optimal dispatch for a microgrid incorporating renewables and demand response. *Renewable Energy*, 101, 16–28. doi: 10.1016/j.renene.2016.08.026.
- Olivier Corradi and Henning Ochsensfeld (2011). *Integration of Fluctuating Energy by Electricity Price Control*. Master thesis, Technical University of Denmark, Copenhagen.
- Pandzic, H., Dvorkin, Y., Qiu, T., Wang, Y., and Kirschen, D.S. (2016). Toward Cost-Efficient and Reliable Unit Commitment Under Uncertainty. *IEEE Transactions on Power Systems*, 31(2), 970–982. doi: 10.1109/TPWRS.2015.2434848.
- Pannocchia, G. and Rawlings, J.B. (2003). Disturbance models for offset-free model-predictive control. *AICHE journal*, 49(2), 426–437.
- Salinas, S., Li, M., and Li, P. (2013). Multi-Objective Optimal Energy Consumption Scheduling in Smart Grids. *IEEE Transactions on Smart Grid*, 4(1), 341–348. doi: 10.1109/TSG.2012.2214068.

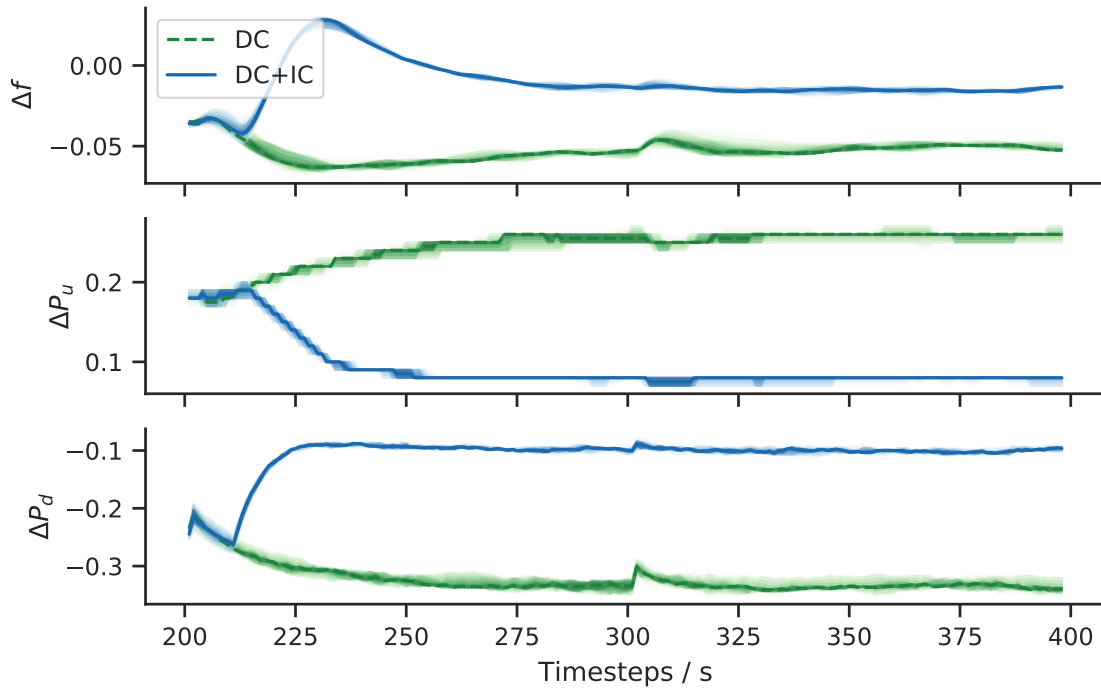

Fig. 8. Comparison of the controller performance without activated Indirect Control support (DC only) and with activated Indirect Control support (DC+IC). The disturbance step ΔP_d is partly compensated and consequently the required step in active power ΔP_u is reduced.

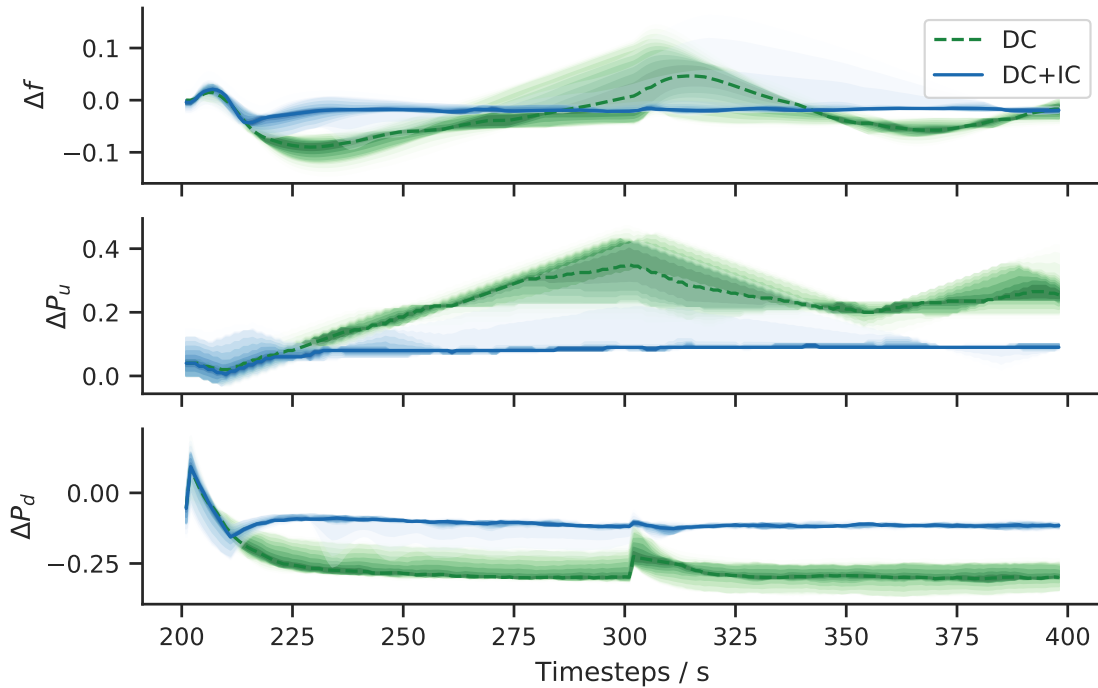

Fig. 9. Comparison of the controller performance without activated Indirect Control support (DC only) and with activated Indirect Control support (DC+IC): In this case the charge patterns of the EVs change throughout the simulation while the price signal is used to reduce the impact of disturbance steps.