



Loss optimizing low power 50 Hz transformers intended for AC/DC standby power supplies

Nielsen, Nils

Published in:

Nineteenth Annual IEEE Applied Power Electronics Conference and Exposition, 2004. APEC '04.

Link to article, DOI:

[10.1109/APEC.2004.1295843](https://doi.org/10.1109/APEC.2004.1295843)

Publication date:

2004

Document Version

Publisher's PDF, also known as Version of record

[Link back to DTU Orbit](#)

Citation (APA):

Nielsen, N. (2004). Loss optimizing low power 50 Hz transformers intended for AC/DC standby power supplies. In *Nineteenth Annual IEEE Applied Power Electronics Conference and Exposition, 2004. APEC '04.* (Vol. 1). IEEE. <https://doi.org/10.1109/APEC.2004.1295843>

General rights

Copyright and moral rights for the publications made accessible in the public portal are retained by the authors and/or other copyright owners and it is a condition of accessing publications that users recognise and abide by the legal requirements associated with these rights.

- Users may download and print one copy of any publication from the public portal for the purpose of private study or research.
- You may not further distribute the material or use it for any profit-making activity or commercial gain
- You may freely distribute the URL identifying the publication in the public portal

If you believe that this document breaches copyright please contact us providing details, and we will remove access to the work immediately and investigate your claim.

Loss Optimizing Low Power 50Hz Transformers Intended for AC/DC Standby Power Supplies

Nils Nielsen

Oersted • DTU, Technical University of Denmark, DTU, Building 325, DK-2800 Lyngby, Denmark

ABSTRACT

This paper presents the measured efficiency on selected low power conventional 50Hz/230V-AC transformers. The small transformers are intended for use in 1W@5V-DC series- or buck-regulated power supplies for standby purposes.

The measured efficiency is compared for cheap off-the-self transformer and for some which are optimized for a lower no-load loss. The optimization is done by simple and low cost means.

INTRODUCTION

This paper cover a selection of the research work performed to support the standby power supply project [1,2],[4-7], which is a cooperative project [8] between the Technical University of Denmark [3] and a number of industrial partners [8].

Usually there is no special attention on the no-load and load dependent losses in very small (0.25 - 5W) conventional 50Hz transformers. The focus is nearly always on the initial manufacturing costs and maybe on the size and weight for the final transformer. The cost for the energy consumed due to losses in the components life time, is normally ignored.

A typical off-the-shelf transformer which can deliver 2-3W output effect in a resistive load (e.g. one suitable for a 5V-DC@1W standby power supply) has a typical no-load loss which is in the range of 0.5W and up to around 1.5W. This comparably high no-load loss causes that the overall efficiency for the small AC-DC power supply never can be very high - especially not at light loads.

Due to this fact it's an obvious issue to have a closer look on the possibilities and, preferably any simple, methods to optimize the small conventional transformer for much lower losses. Especially it's interesting to investigate what happens to the price, size and weight for the optimized transformer.

- What happens if the transformer is optimized for high efficiency?

- Is it possible to make any essential improvements even by lowering the maximum core flux density B_{max} ?
- In that case by how much?
- Is more exotic core materials required to achieve any reasonable results?

As an result of these considerations, reasonable accurate and traceable measurement must be obtained on small transformers. Unfortunately these measurements is normally not available from the manufactures - maybe because they never measured them or just due to the low attention to the issue. Because of the mentioned fact, a big part of this research project was to produce accurate reference measurements, which should document how these small standard transformer "actually" is performing. The reference measurements is used as a data base for comparison of new (without 50Hz transformers) designs of very low power 1W, 230V-AC to 5V-DC power supplies, which are designed by using e.g. switch mode topologies. The measured reference data is used to support and ease comparison of any claimed improvements on these new power supply designs.

DISCUSSION

The transformer optimization is done by changing between the two core sheet material quality types (0.50mm, 0.35mm) and varying the B_{max} in three steps (0.50T, 0.75T, 1.00T). This paper covers only the result of comparisons of two types of transformer's, the off-the-shelf type and the best cost effective optimized one. Only the results from the final found and most optimal combination is documented here. The full optimization report is [6].

The most optimal combination is found to be a 0.35mm core sheet thickness and a B_{max} of 0.75T

The off-the-shelf type transformer uses a 1.7W/kg core material to form its core. Its core is a 0.50mm sheet iron material which is the industry's preferred (cheap) core material. An only marginally more expensive core material is used for design of the optimized transformers. This better material is a 0.35mm sheet core material, which is referred to as a 1W/kg material. The 1.7W/kg and 1W/kg refers AC-core losses per kilo core material at a sinus flux with a peak flux density B-max at 1Tesla.

A result from this research was that there is no reason at all to use the 1.7W/kg core sheet material - the no-load losses was as expected approximately twice the value as for the 1W/kg material, and the choose of an even lower 0.50T B-max showed that no reasonable reduction in no-load losses could be achieved. The reason was; it is very difficult to assemble the core parts to the required high precision (to avoid any residual air gaps) to have any benefit of the theoretical lower core losses.

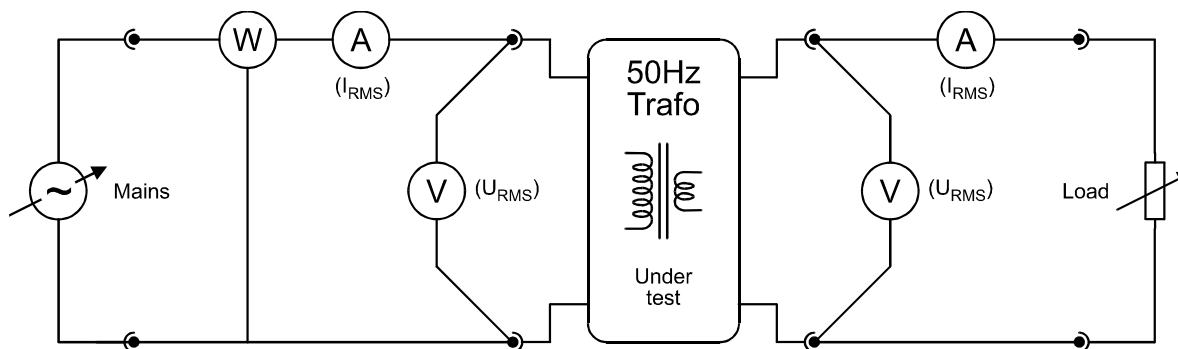

Figure 1 The Transformer Test Circuit

The measurement is made with as high quality as possible. The most raw-measurements is made with 0.1% accuracy. The overall target accuracy is $\pm 1\%$ or better. The primary (mains) voltage is provided by a controlled sinus voltage source (Hewlett Packard HP6843A). The input power is measured by a power analyzer (Voltech PM3000A). The currents and voltages is measured by precision instruments (Hewlett Packard HP34401A). All the relevant measurements is performed as 4-wire configuration as shown in figure 1.

The measurements is recorded on the cheap off-the-shelf transformers, and on the loss optimized transformer's which are special manufactured [5] for this research. The overall loss optimization is done with respect to both cost and selection of raw-materials. Please note, this research has not in mind to investigate what results that might be obtained by choosing exotic and expensive state-of-the art core materials. In any way, no special manufacturing methods or exotic core materials are used during the optimized transformer design.

Common for the optimized transformers is that the loss reduction is done by the expense of a higher raw-material usage. The special designed trans-formers is physically larger compared to the off-the-shelf transformers. The final loss optimized trans-former

uses a core with dimensions comparable to the core used in a 12VA off-the-shelf transformer. But the transformer manufacture has told that the final cost increase not might be more than 10-15% per item compared to the off-the-shelf transformer.

Comments to the measurements

The final no-load power loss for the optimized transformers is very sensitive to any unwanted scattered residual air gaps in the core. During the test manufacturing it has been evident that special attention must be taken to ensure these air gaps is avoided during the core assembly process.

The two optimized transformers mentioned in this paper shows a remarkable difference in the no-load losses even through they are identical when not loaded. As it can be seen in table 2 the primary inductance's differs a lot. The much lower primary inductance in one transformer causes a higher inductive current, which then causes an increased resistive loss in the primary winding.

Figure 1-4 shows the measurements for the selected transformers. Remark the curve for P.va.trafo and P.prim.trafo on figure 4 nearly is close to equal and thereby not very visible.

The Experimental Results (U-primary is 230V-AC)

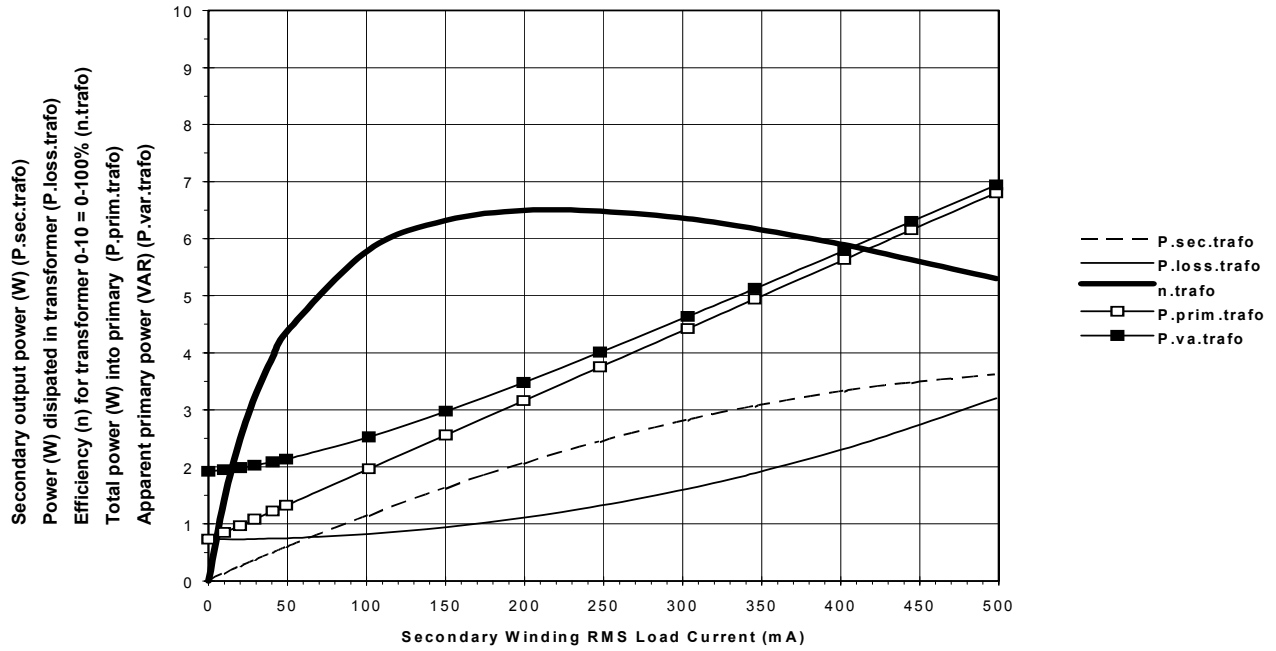

Figure 2 TR#1: A off-the-shelf transformer intended for a 5V-DC@1W series regulated power supply

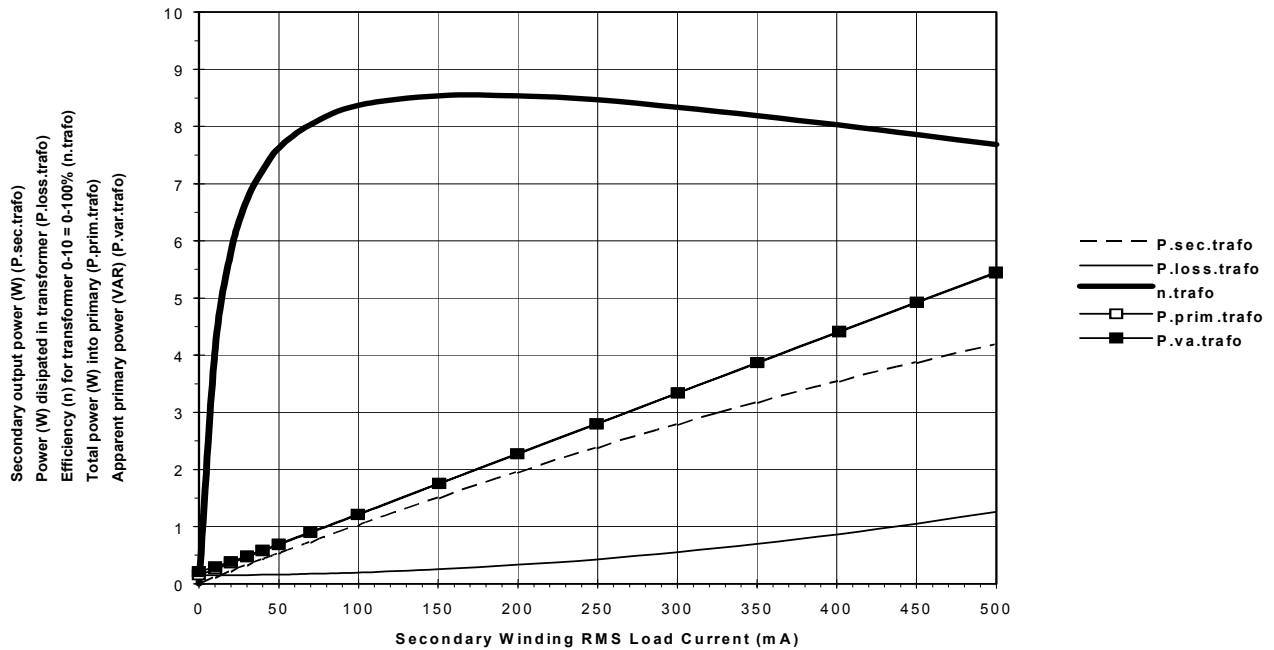

Figure 3 TR#2: The optimized transformer intended for a 5V-DC@1W series regulated power supply

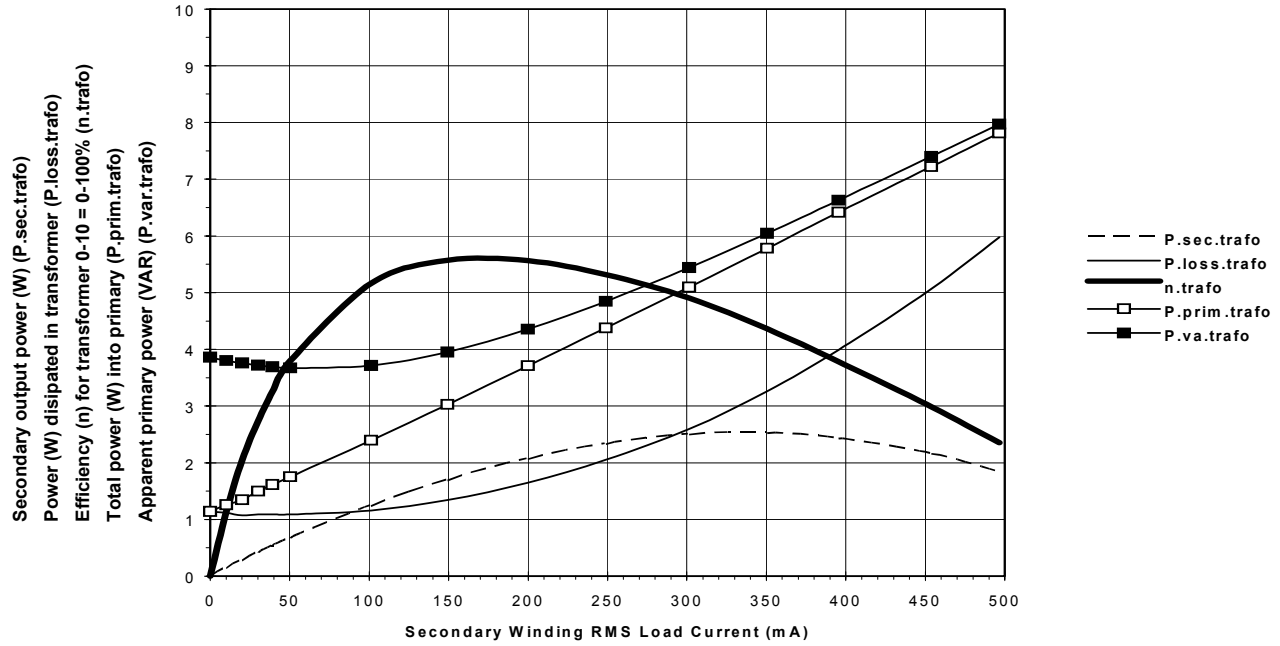

Figure 4 TR#3: The off-the-shelf transformer intended for a 5V-DC@1W buck based power supply

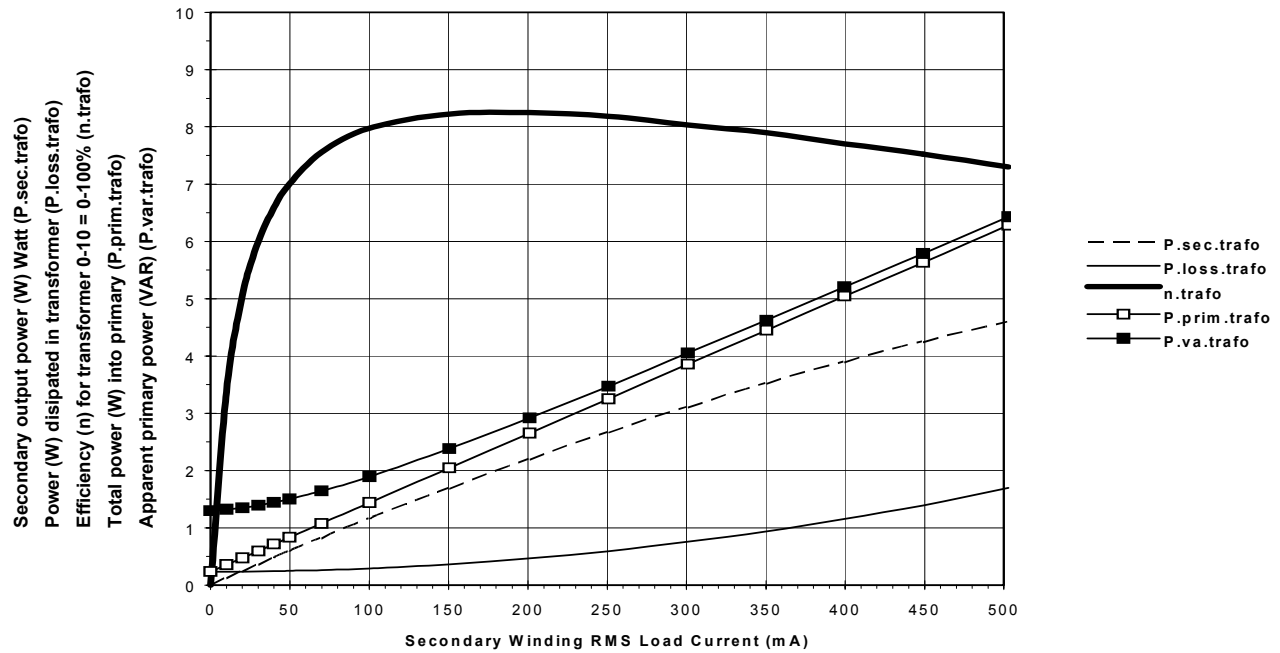

Figure 5 TR#4: The optimized transformer intended for a 5V-DC@1W buck based power supply

The Transformers:

TR#1: Type: DT1020001 [figure 2]
 Low cost off-the-shelf transformer
 Transformer is intended for an 1W / 5V-DC series regulated power supply

TR#2: Type: B075W10A [figure 3]
 Optimized low cost transformer
 intended for a 1W / 5V-DC series regulated power supply

TR#3: Type: DT1010101 [figure 4]
 Low cost off-the-shelf transformer
 intended for a 1W / 5V-DC buck regulated power supply

TR#4: Type: B075W10 [figure 5]
 Optimized low cost transformer
 intended for a 1W / 5V-DC buck regulated power supply

The Initial Measured Transformer Data:

	TR#1	TR#2	TR#3	TR#4
#M1 - Temp.	23°C	23°C	23°C	23°C
#M2 - Rp.dc	1539ohm	941.5ohm	1991ohm	949.2ohm
#M3 - Rs.dc	4.778ohm	2.311ohm	9.958ohm	2.915ohm
#M4 - Rs.ps.dc	9.115ohm	4.289ohm	17.43ohm	5.507ohm
#M5 - Lp	21.17H	218.8H	20.41H	63.45H
#M6 - Ls	90.80mH	973.6mH	125.9mH	295.9mH
#M7 - Ls.ps	5.550mH	3.904mH	6.715mH	5.158mH
#M8 - Us.EMF	12.21V	10.58V	14.09V	12.02V
#M9 - Us.nl	10.48V	9.403V	11.59V	11.26V
#M10 - Pp.nl	4.7288W	2.985W	4.619W	3.450W
#M11 - Pp.nol	729mW	151mW	1136mW	234mW
#M12 - n-ps	0.05288	0.04584	0.06102	0.05210
#M13 - Rs.ps.ac	10.25ohm	4.420ohm	19.33ohm	5.685ohm

Table 2 Comparison Of Measured Transformer Data

Transformer data as given by the manufacturer:

- #P1: Transformer reference name
- #P2: Rated output voltage
- #P3: No-load voltage (EMF-voltage)
- #P4: Rated load current
- #P5: Rated output effect
- #P6: No-load loss
- #P7: EI-core (type and dimensions)
- #P8: Overall moulded transformer weight



Figure 6 The Three Used Transformer sizes

	#1	#2	#3	#4
#P1	DT1020001	B075W10A	DT1010101	B075W10
#P2	9v	10.5V	9V	12V
#P3	12V	-	14V	-
#P4	333mA	267mA	267mA	267mA
#P5	3VA	(12VA)	2.4VA	(12VA)
#P6	<0.6W	<nothing	<0.7W	<nothing
#P7	EI38/13.6	EI48/20.5	EI30/15.5	EI48/20.5
#P8	148g	322g	96g	321g

Table 1 Comparison Of Manufacturer Data

Measured data for transformer:

- #M1: Core temperature (accuracy is $\pm 1^\circ\text{C}$)
- #M2: Primary winding resistance, Rp.dc
- #M3: Secondary winding resistance, Rs.dc
- #M4: Calculated sec. short circuit resistance, Rs.ps.dc (calculated by measured n.ps)
- #M5: Primary winding inductance, Lp (100Hz)
- #M6: Secondary winding inductance, Ls (100Hz)
- #M7: Secondary leakage inductance, Ls.ps (100Hz - with shorted primary)
- #M8: Secondary EMF voltage, Us.EMF (230V)
- #M9: Secondary nom. load voltage, Us.nl
- #M10: Primary nominal-load input power, Pp.nl
- #M11: Primary no-load input power, Pp.nol
- #M12: Measured Turns ratio ($n = n_s/n_p$), n.ps
- #M13: Measured secondary short circuit resistance Rs.ps.ac

Figure 7 shows the overall equivalent circuit for the transformer. $R_{p,dc}$ and $R_{s,ac}$ is the DC-copper resistance. $L_{p,l}$ and $L_{p,s}$ is primary and secondary

leakage inductance, only the effective one $L_{s,ps}$ as seen from the secondary is measured. R_m is the overall core losses. Finally TR is an ideal transformer.

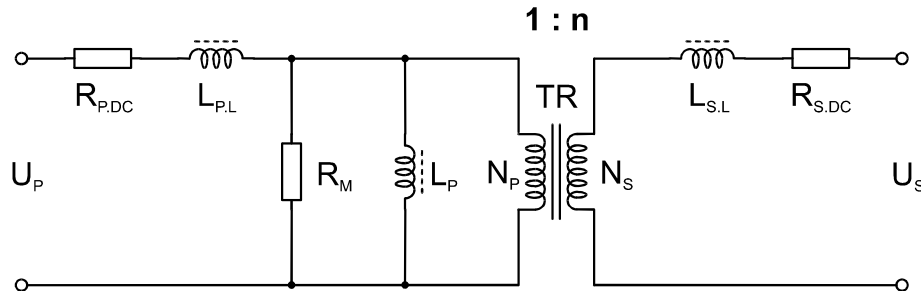

Figure 7 The Overall Transformer Equivalent Circuit

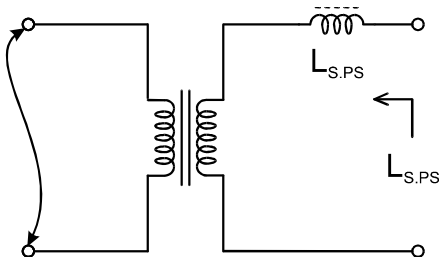

Figure 8 Measurement Of The Secondary Inductance

The same circuit shown as figure 8 with $L_{s,ps}$ replaced with $L_{s,ps,dc}$ is used for measuring the secondary short circuit resistance $L_{s,ps,dc}$.

CONCLUSION

The research confirms that losses can be reduced drastically compared to a conventional designed off-the-shelf 50Hz transformer. It is especially the no-load losses which can be reduced, and it can be done so without the use of any special core materials.

The no-load losses can easily be reduced around four times compared to an typical off-the-shelf transformer. The overall loss reduction is achieved only by using a lower B_{max} (0.75T) and a standard - but thinner iron core sheet material (0.35mm). Other values of B_{max} has been tested, but a B_{max} around 0.75T appears in more respects to be the most optimal choice.

A drawback for this principle of loss reduction is that it requires a larger core size, which means that the core weight and the overall cost also increases.

The final loss optimized transformer uses a core with dimensions comparable to the core used in a 12VA off-the-shelf transformer.

But a very important issue is, that the transformer manufacturer has told that the cost increase not might be more than 10-15% per transformer compared to the off-the-shelf transformer.

REFERENCES

1. N. Nielsen, "Standby Power Supply - An energy efficient mains driven ultra low power supply", (Danish original title: "Standby Power Supply - En energieffektiv netdrevne ultra laveffekts spaendingsforsyning"), Ph.D. Thesis, DTU, DK-2800 Lyngby, Denmark, 31 May 2000, 244 pages. (In Danish)
2. N. Nielsen, "An ultra low-power APDM-based switchmode power supply with very high conversion efficiency", Proceedings of the 16th IEEE Applied Power Electronics Conference, Anaheim, March 4-8, Vol. 1, pp. 81-87 (2001).
3. Technical University of Denmark - DTU, Anker Engelundsvej 1, DK-2800 Lyngby, Denmark., (<http://www.dtu.dk>).
4. Danish Energy Agency, Amaliegade 44, DK-1256 Copenhagen - K., (<http://www.ens.dk>)
5. Dantrafo A/S, Islandsvej 28, DK-8700 Horsens, Denmark, (<http://www.dantrafo.dk>).
6. N. Nielsen, "Reference Measurements On Conventional 50Hz SPS Topologies", (Danish original title: "Reference maalinge paa konventionelle 50Hz SPS topologier"), DTU, DK-2800 Lyngby, 15 July 1999, Denmark, 114 pages. (In Danish)
7. N. Nielsen, "Reference Measurements On SPS Ready Transformers", (Danish original title: "Reference maalinge paa SPS egnede 50Hz transformere"), DTU, DK-2800 Lyngby, 18 April 1999, Denmark, 125 pages. (In Danish).
8. The cooperative partners are: 1.) Bang & Olufsen, Peter Bangs Vej 15, DK-7600 Struer, Denmark, (<http://www.bang-olufsen.dk/>). 2.) Dantrafo A/S, Islandsvej 28, DK-8700 Horsens, Denmark, (<http://www.dantrafo.dk>). 3.) Electrolux Hot Tech-Center, Sjaellandsgade 2, DK-7000 Fredericia, Denmaek, (<http://www.electrolux.dk>).