



Power Management for Energy Systems

Hovgaard, Tobias Gybel

Publication date:
2013

Document Version
Publisher's PDF, also known as Version of record

[Link back to DTU Orbit](#)

Citation (APA):
Hovgaard, T. G. (2013). Power Management for Energy Systems. Sound/Visual production (digital)

General rights

Copyright and moral rights for the publications made accessible in the public portal are retained by the authors and/or other copyright owners and it is a condition of accessing publications that users recognise and abide by the legal requirements associated with these rights.

- Users may download and print one copy of any publication from the public portal for the purpose of private study or research.
- You may not further distribute the material or use it for any profit-making activity or commercial gain
- You may freely distribute the URL identifying the publication in the public portal

If you believe that this document breaches copyright please contact us providing details, and we will remove access to the work immediately and investigate your claim.



STANFORD
UNIVERSITY



Wind. It means the world to us.™



Power Management for Energy Systems

Tobias Gybel Hovgaard^{1,2}, Lars F. S. Larsen¹, Morten Skovrup³, Stephen Boyd⁴, and John B. Jørgensen²

1) Vestas Technology R&D, Aarhus N, Denmark.

2) Dept. of Applied Mathematics and Computer Science, Technical University of Denmark.

3) IPU Technology Development, Denmark.

4) Stanford University

*) In collaboration with: Danfoss A/S, Electronic Controls R&D, Denmark.

Challenge and Motivation

- **Wind power is the most important renewable energy source today.**
- **Goals for reduced CO2 emission, increased utilization of renewable energy, and phase out of fossil fuels.**
- **E.g. in Denmark: increase the share of wind power to 50% of the electricity consumption by 2020 and fully cover the energy supply by renewable energy by 2050.**
- **Wind power production fluctuates → flexible power consumption is needed (smart grid technologies).**

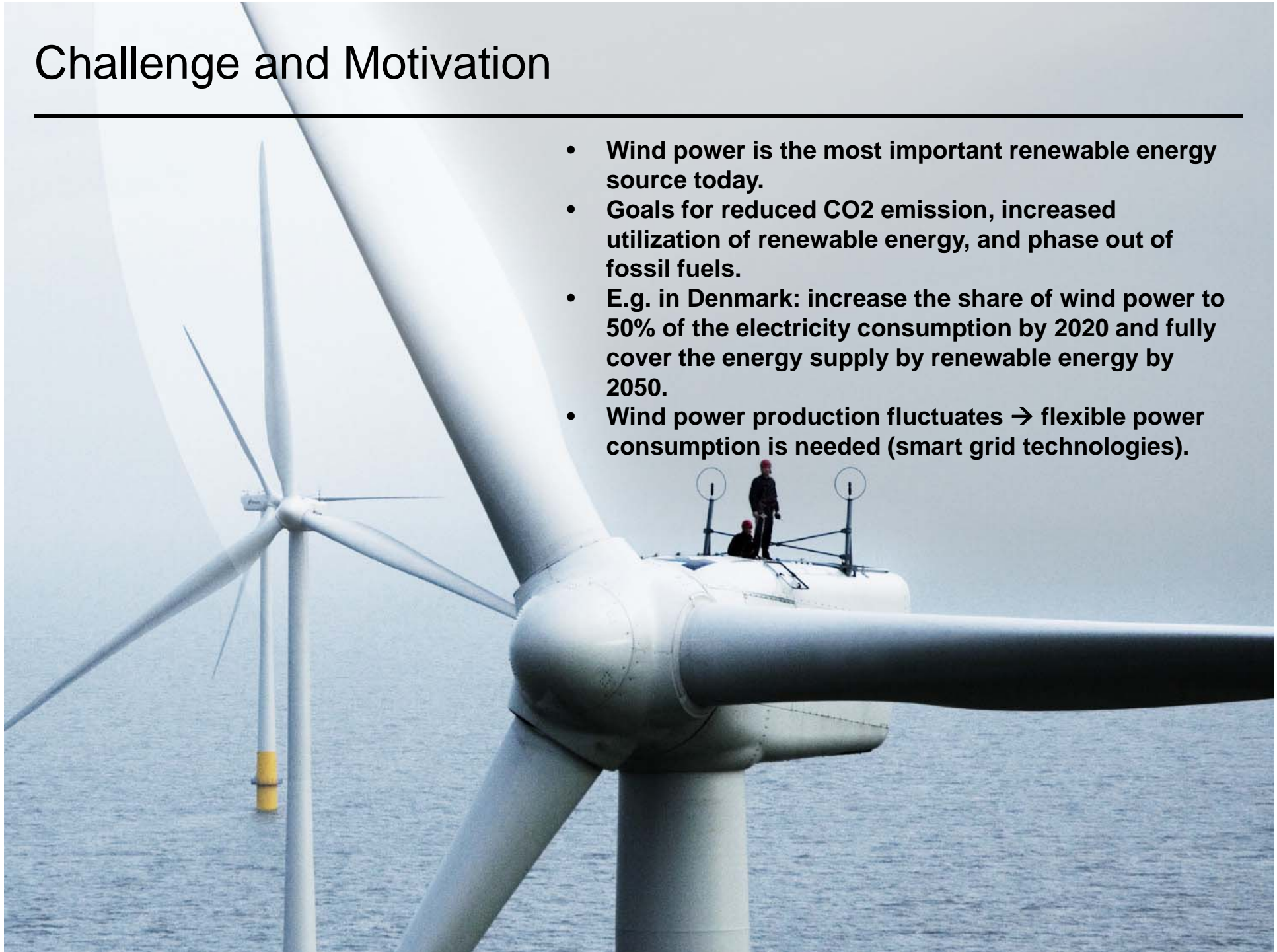

Intelligent load-shifting and scheduling by storing “coldness” for:

- Peak avoidance (foreseeing peaks can reduce dimensioning of the system)
- Minimal power consumption (Cooling at colder periods is more efficient)
- Minimal cost (Energy prices may vary over the day)
- Flexible consumption (More renewable energy calls for flexible power consumption)

Example: Drive from A to B with minimal fuel consumption.

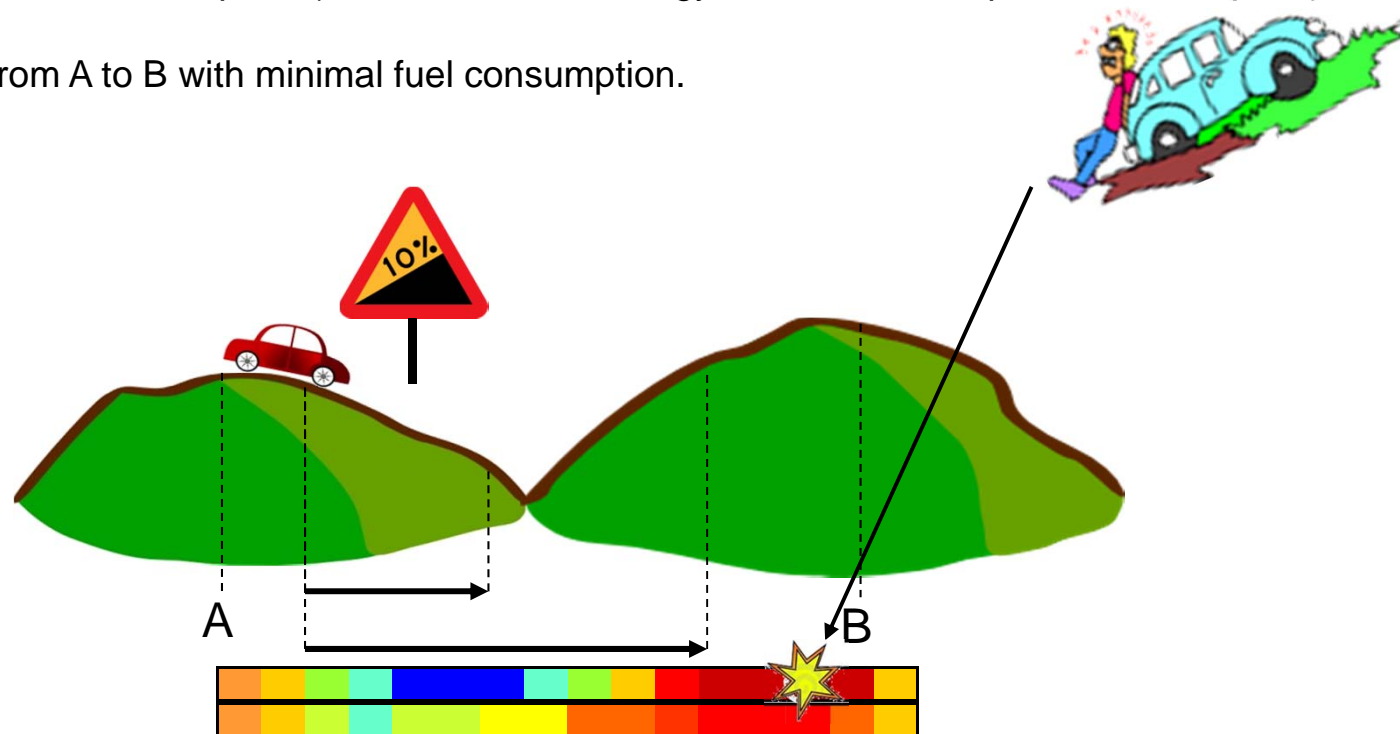

Example: Smart Grid (Flexible consumption).

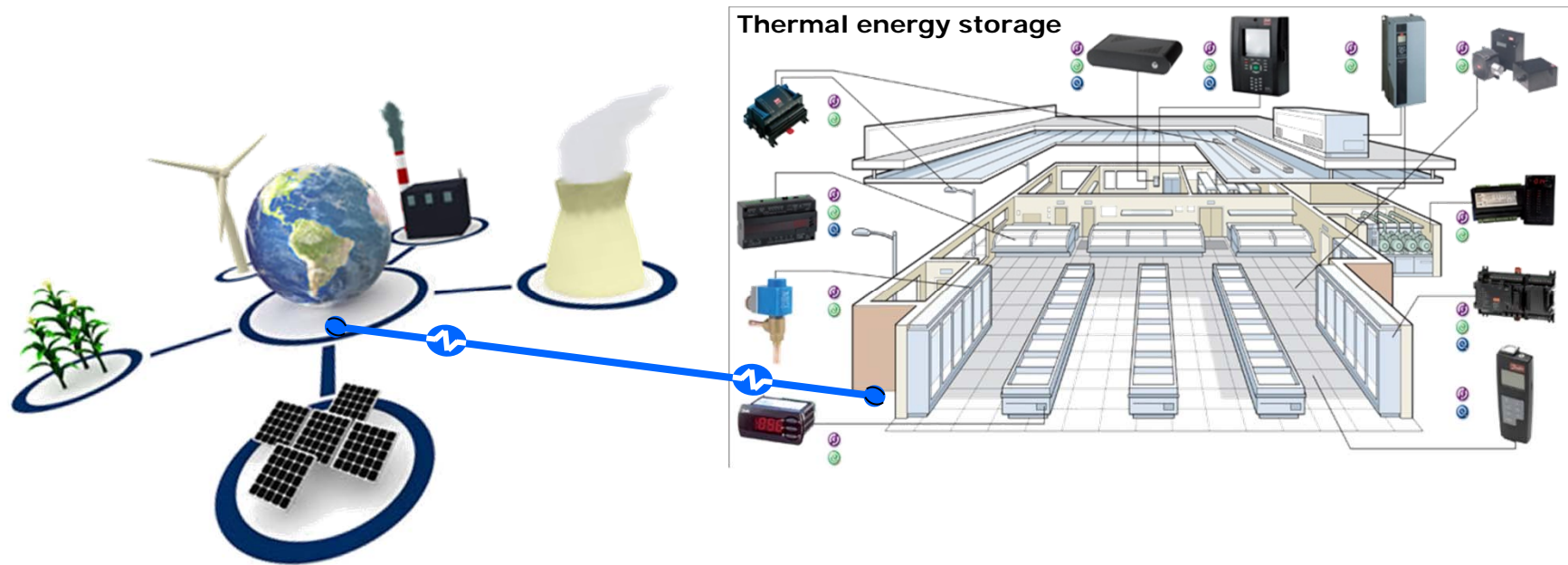

Example: Smart Grid (Flexible consumption).

Economic Model Predictive Control (MPC)
demonstrated on power distribution portfolio
including a cold storage with flexibility.

Presented at CDC 2010.

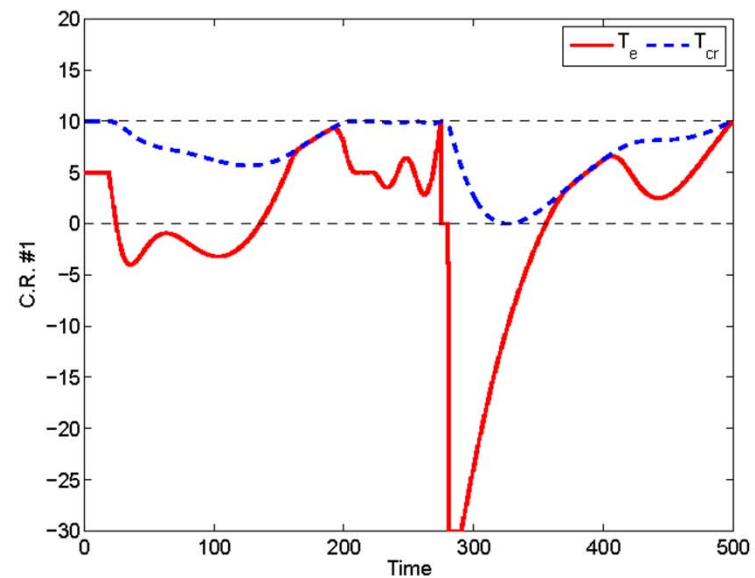
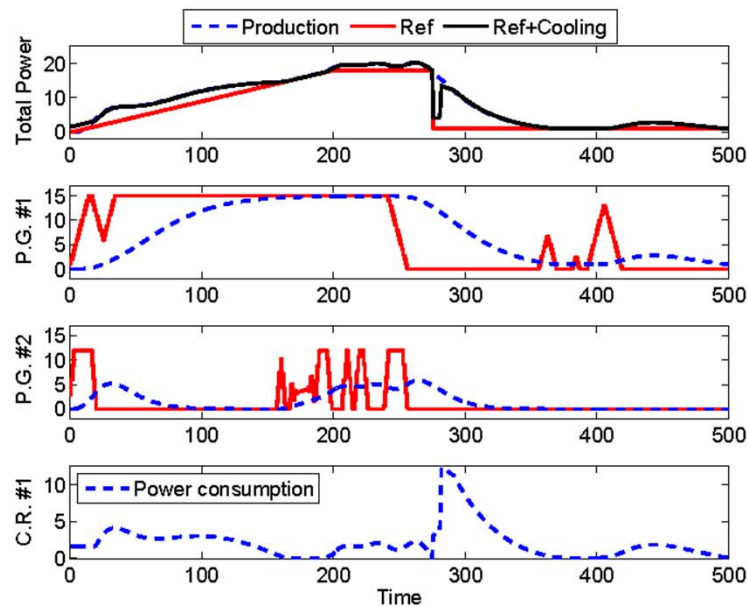

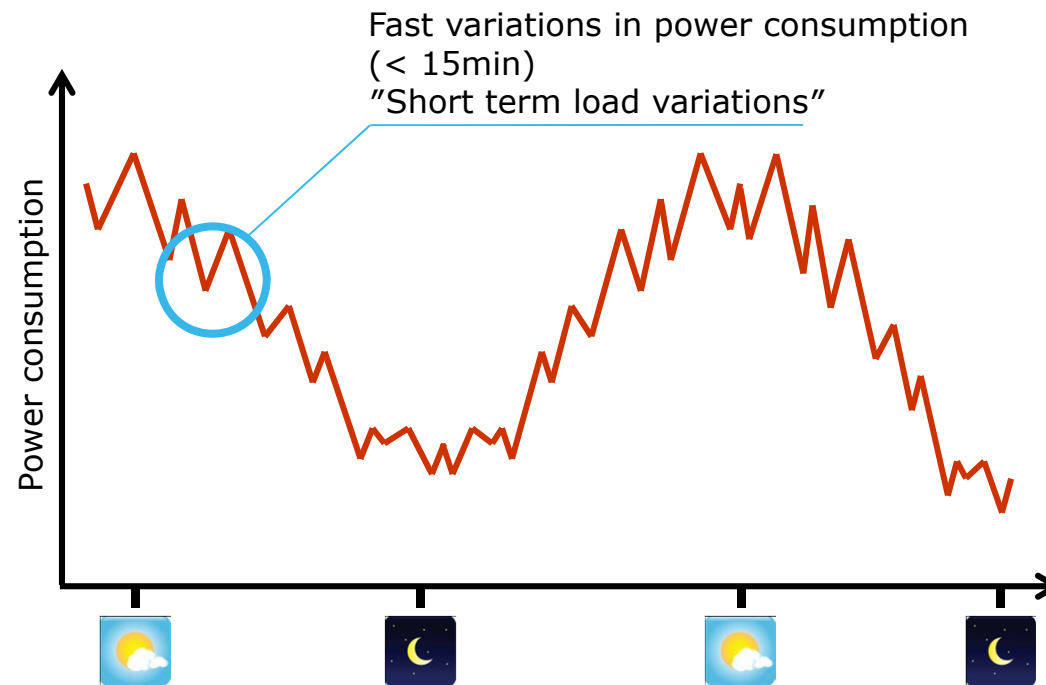

Challenge and Motivation



STANFORD
UNIVERSITY

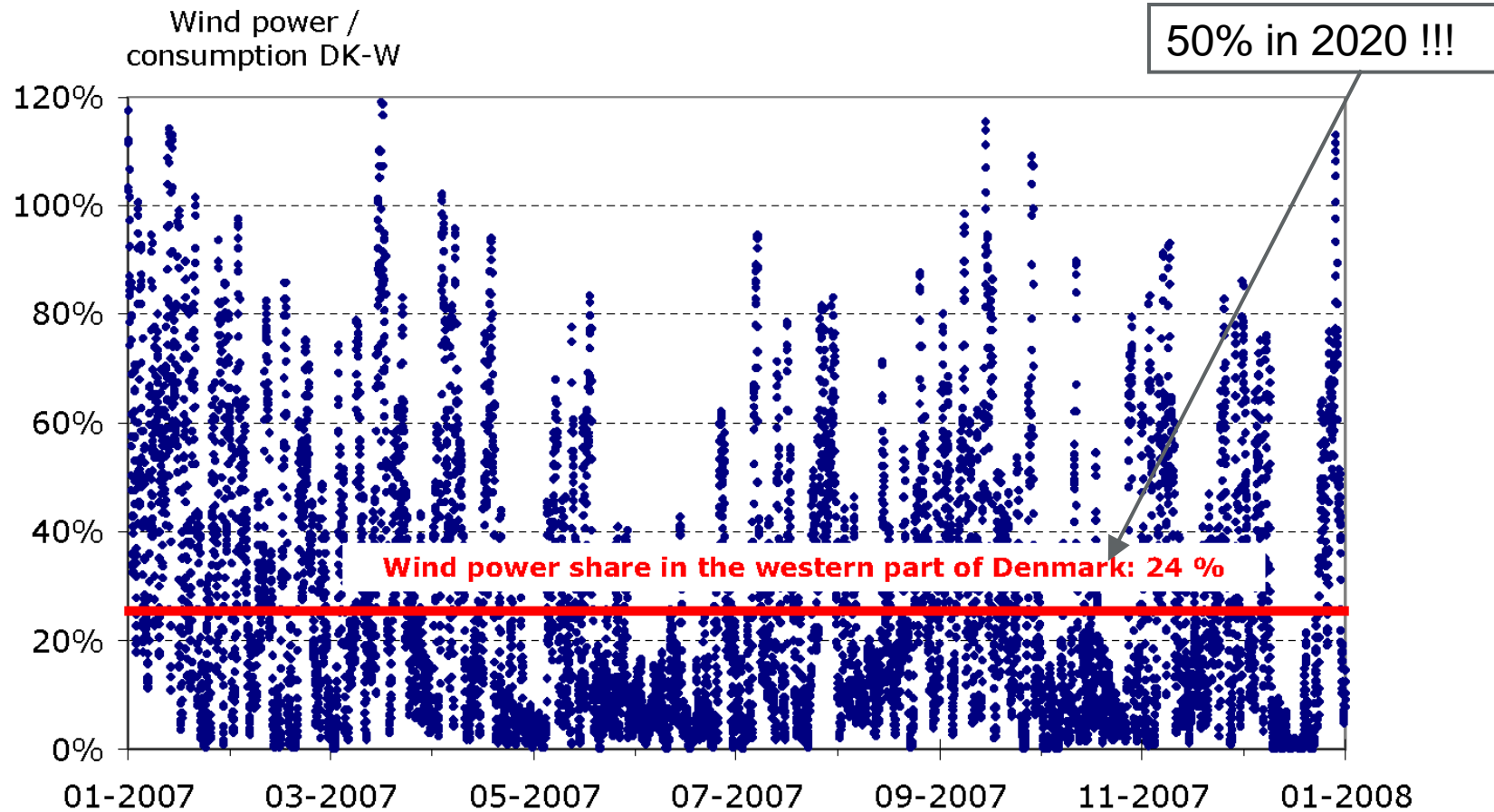

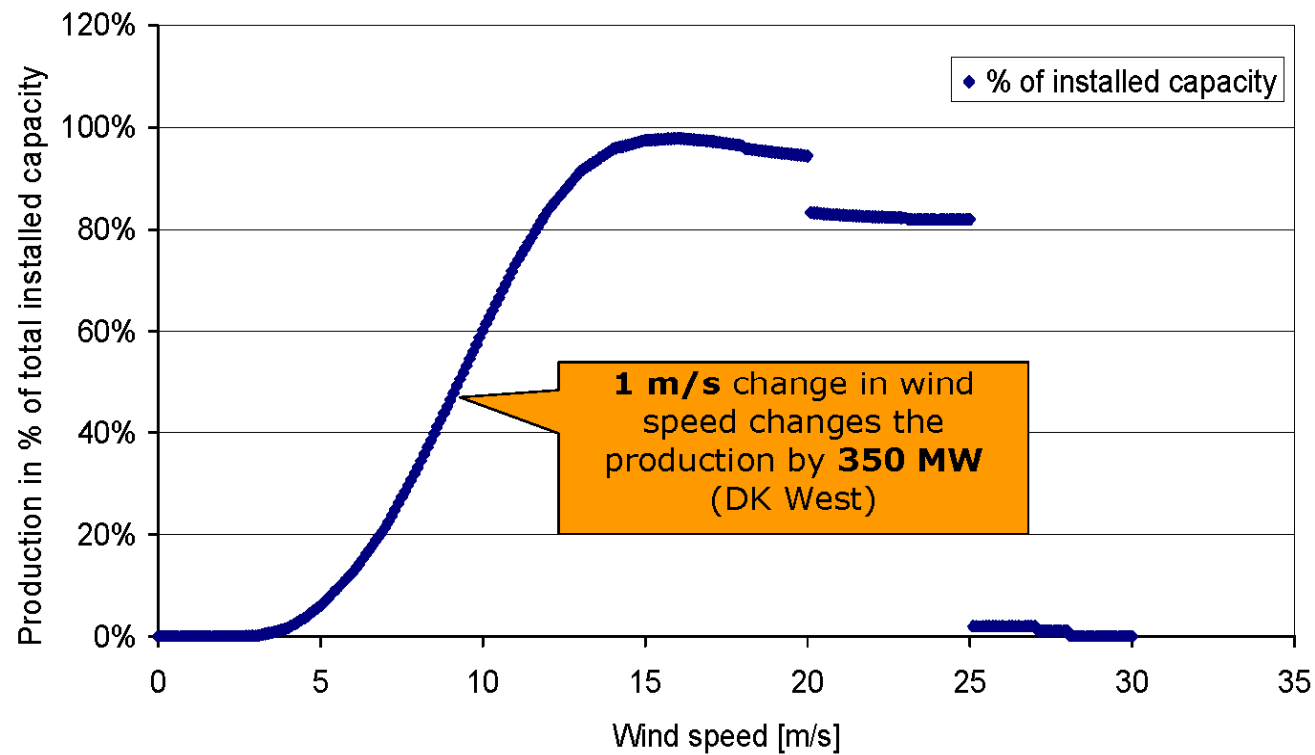

Regulating Power

A brief introduction:

- Ancillary service in order to balance production and consumption (stabilize frequency)
- Up-regulating power: increased production or decreased consumption
- Down-regulating power: decreased production or increased consumption
- Different types (amounts, activation times, automatic/manual)

Regulating Power

A brief introduction:

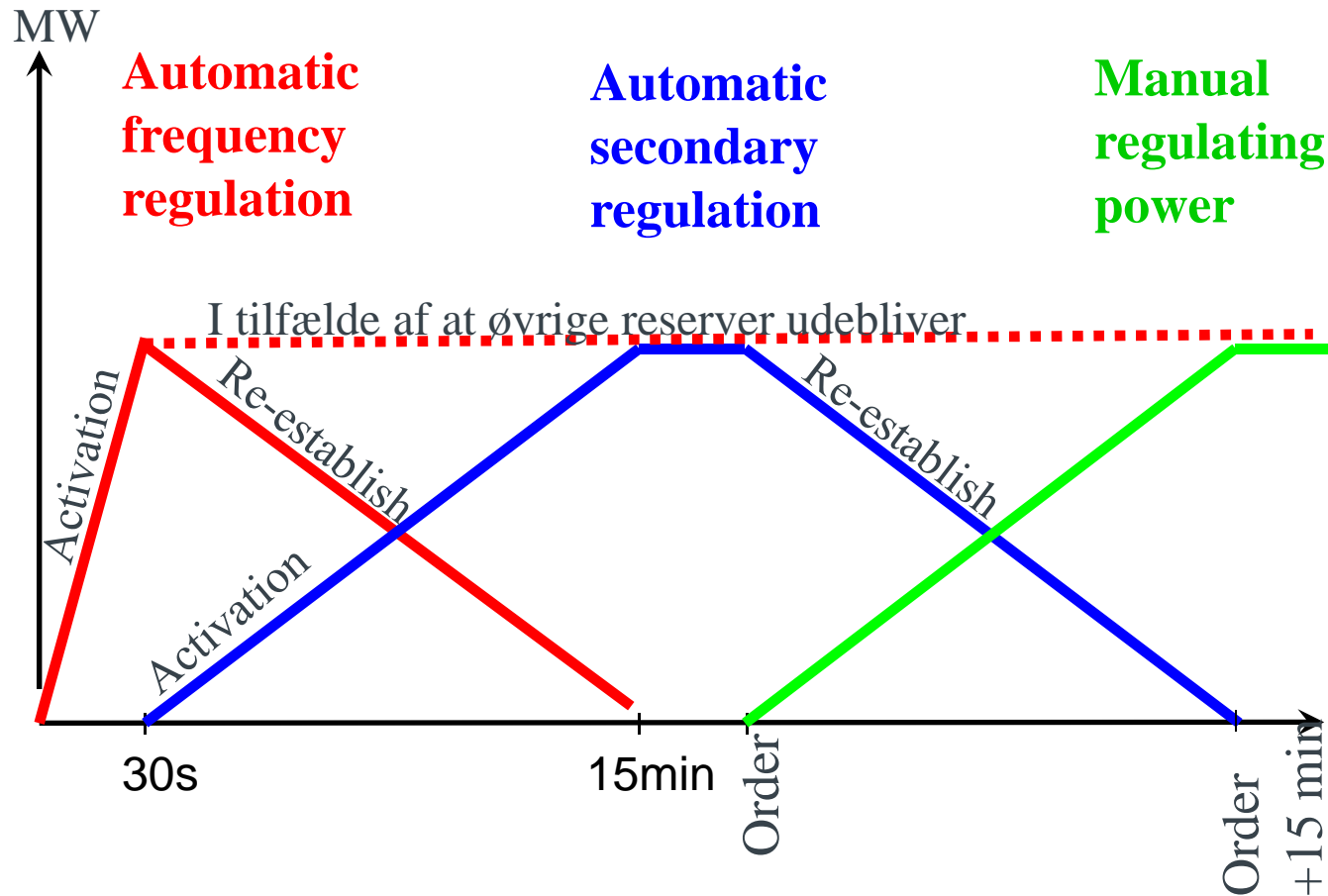

Regulating Power

Primary regulation:

- Automatic frequency dependent activation
- Uphold activated capacity for 15 min, re-establish in 15 min.
- No extra payment for activated power
- Availability payment independent of actual activation (non-symmetric up/down)

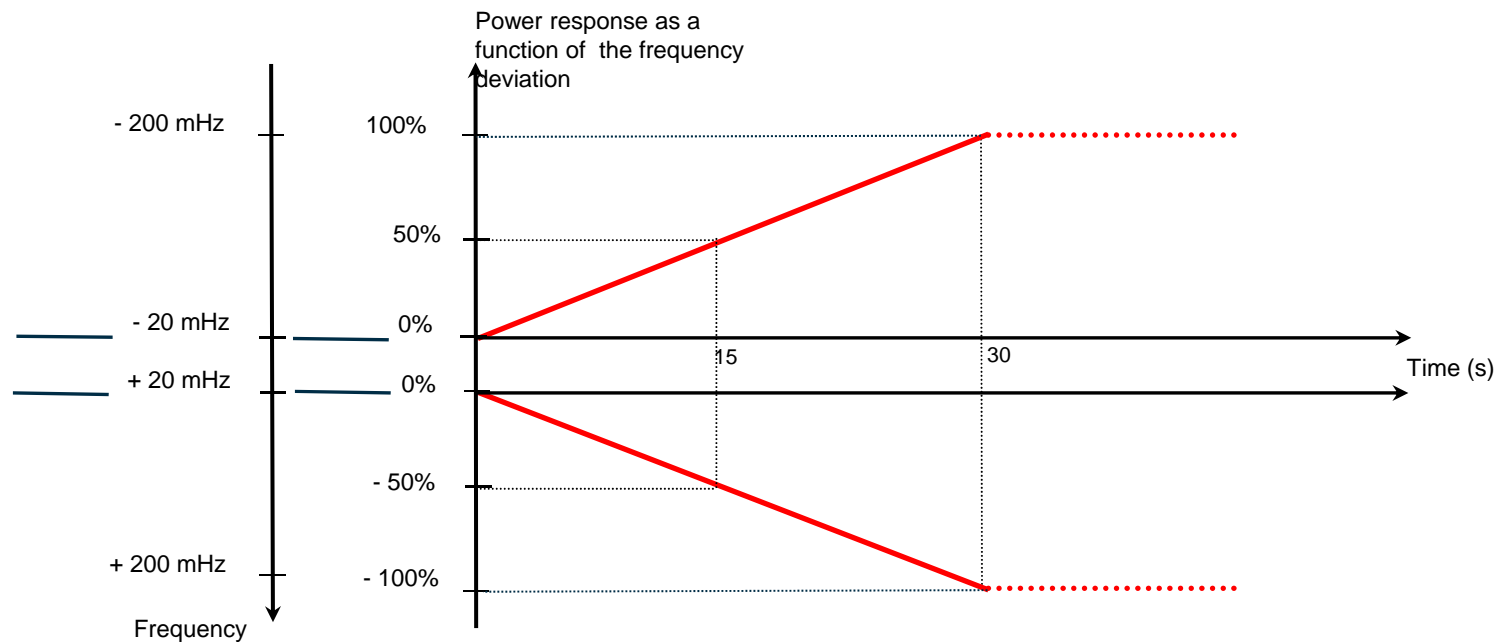

Flexible consumption with intelligent load-shifting and scheduling by storing energy in the form of “coldness”:

1. Utilize thermal mass in e.g. stored goods in supermarkets.
2. Food temperatures allowed to vary within defined limits.
3. Our studies reveal electricity cost savings up to 30%.

But:

1. Food temperatures unknown!
2. Vast variety of systems!
3. Little computational power!

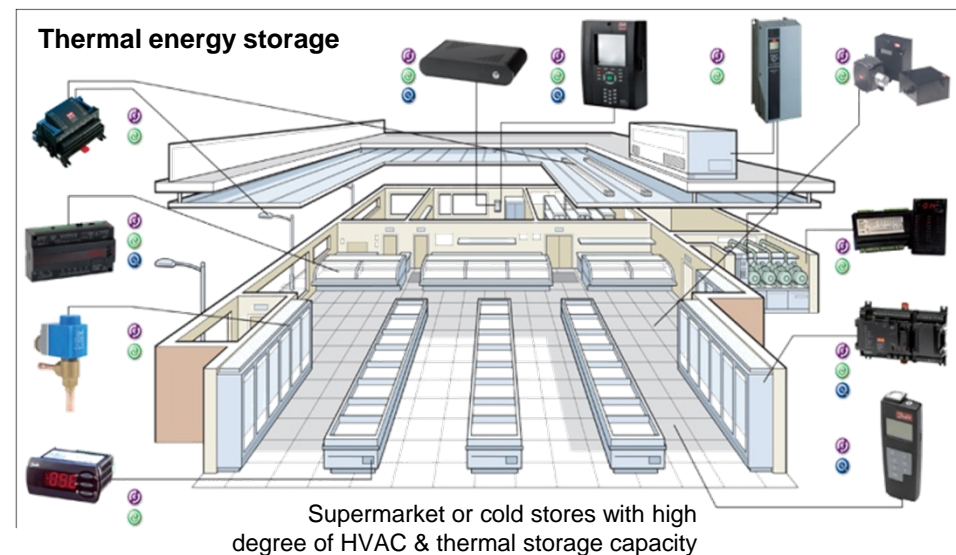

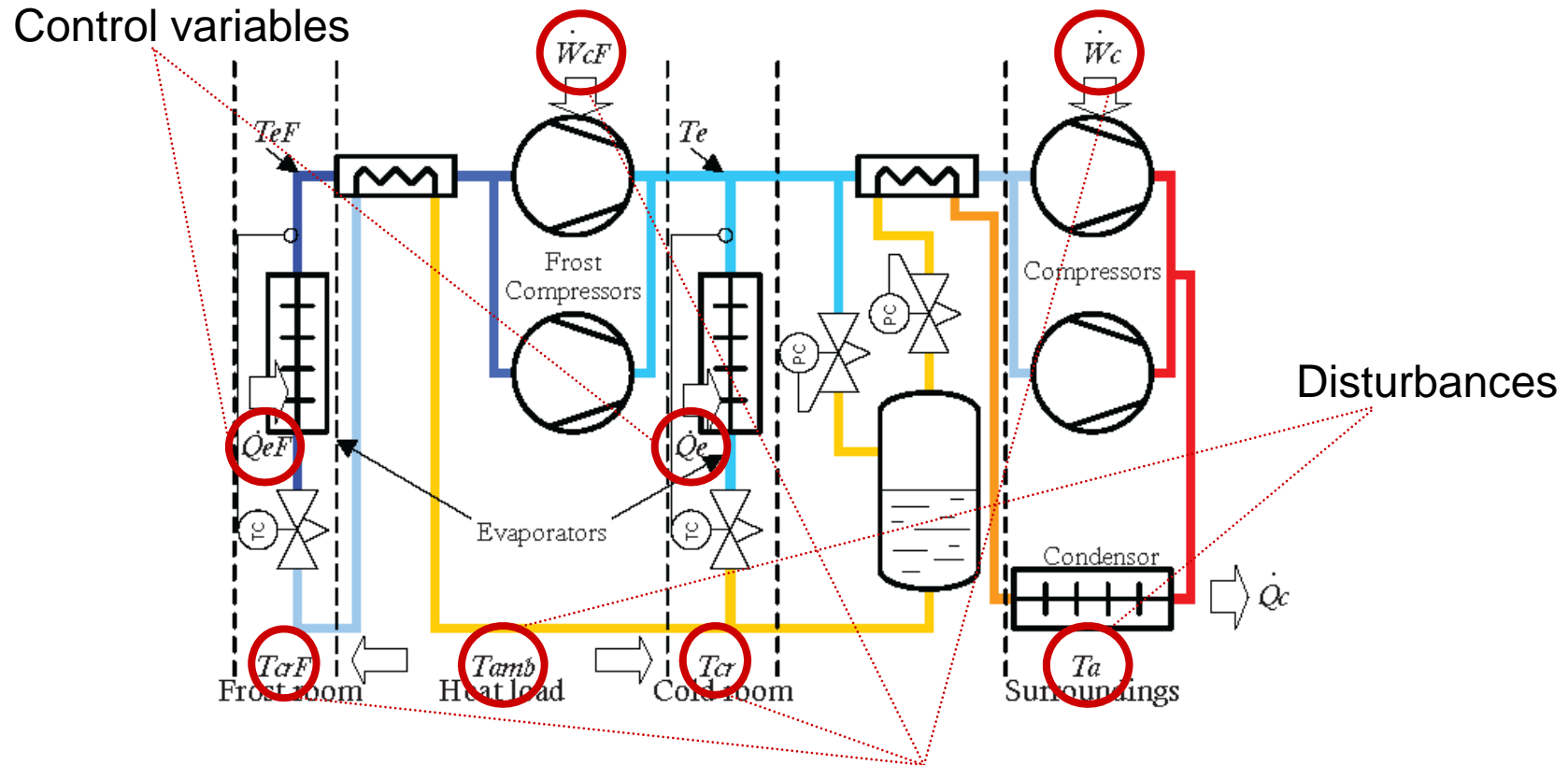

Economic Model Predictive Control (MPC)

Controller cost function:

- With e.g. for regulation:

MPC Control problem:

$$\Phi(x, u) = \sum_{k=0}^{N-1} L(x(k), u(k))$$

$$L(x, u) = \frac{1}{2} ((x - x_{sp})' Q (x - x_{sp}) + (u - u_{sp})' R (u - u_{sp}))$$

$$\min_u \Phi(x, u), \text{ s.t.}$$

$$x(k+1) = Ax(k) + Bu(k)$$

$$k = 0, \dots, N-1$$

$$g(x(k), u(k)) \leq 0$$

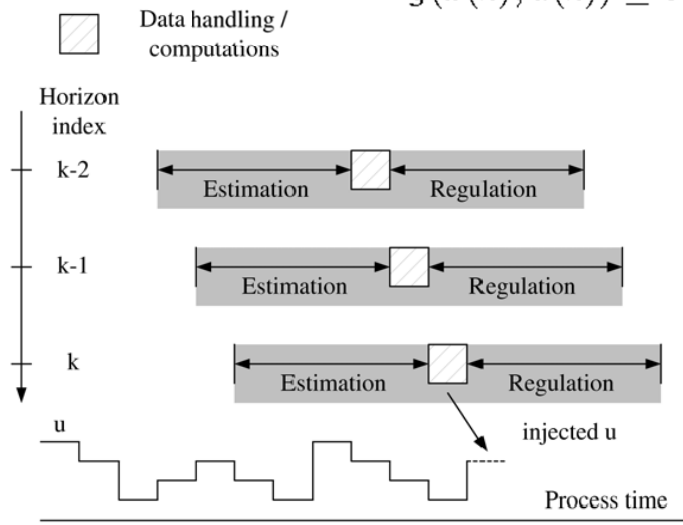
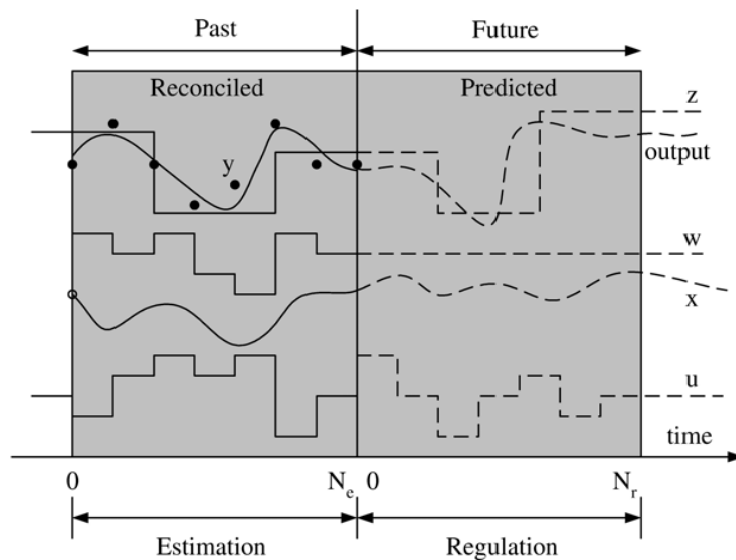

Economic Model Predictive Control (MPC)

- Solve an optimization problem at each sample.
 - Minimize an economic objective related to operation of the system.
 - Repeat in a receding horizon manner
-
- + Incorporates predictions of future prices, temperatures, etc.
 - + Handles constraints naturally.
 - + Intuitive formulation of the cost of operation into a control problem.
-
- Relies on a model of the system and predictions of the disturbances.
 - Can involve quite complicated numerical optimization problems.

Example: Uncertain predictions and models.

- Example: Drive from A to B with minimal fuel consumption. Stay on the road!

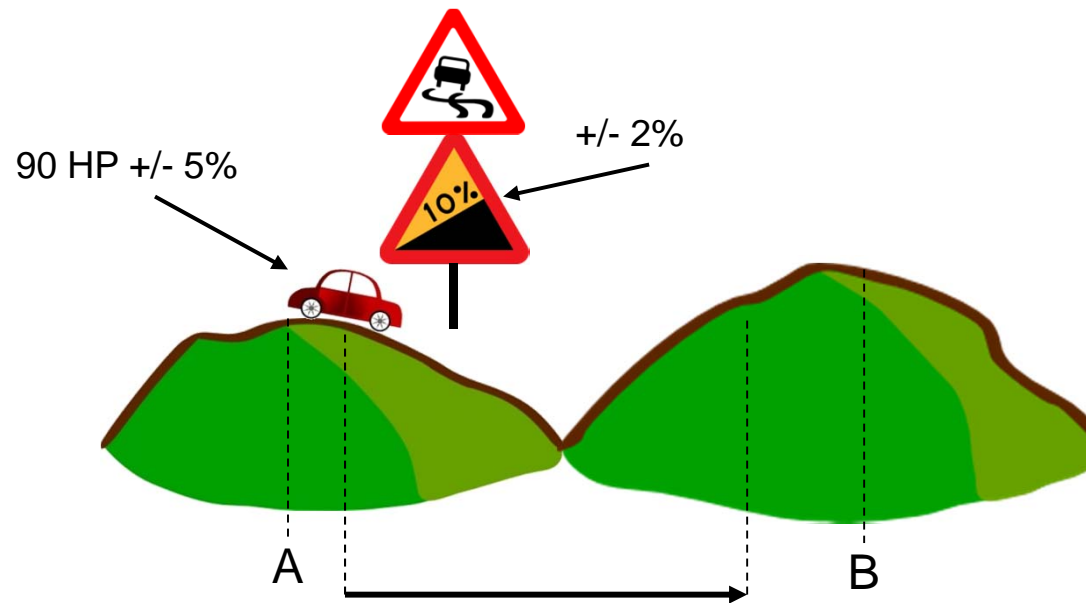

Example: Uncertain predictions and models.

Second Order Cone Programming (SOCP) for
uncertainties in Economic MPC problems.

Presented at CDC-ECC 2011

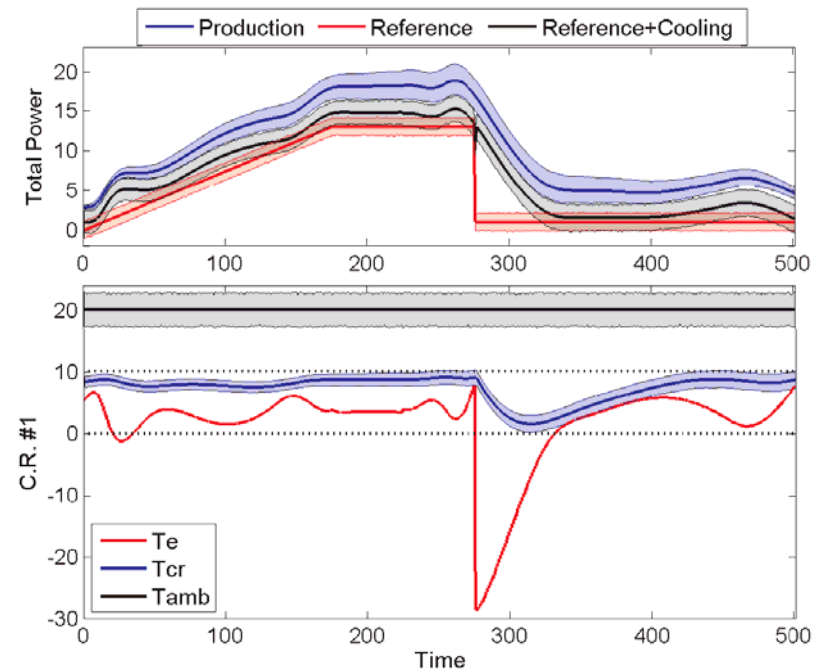
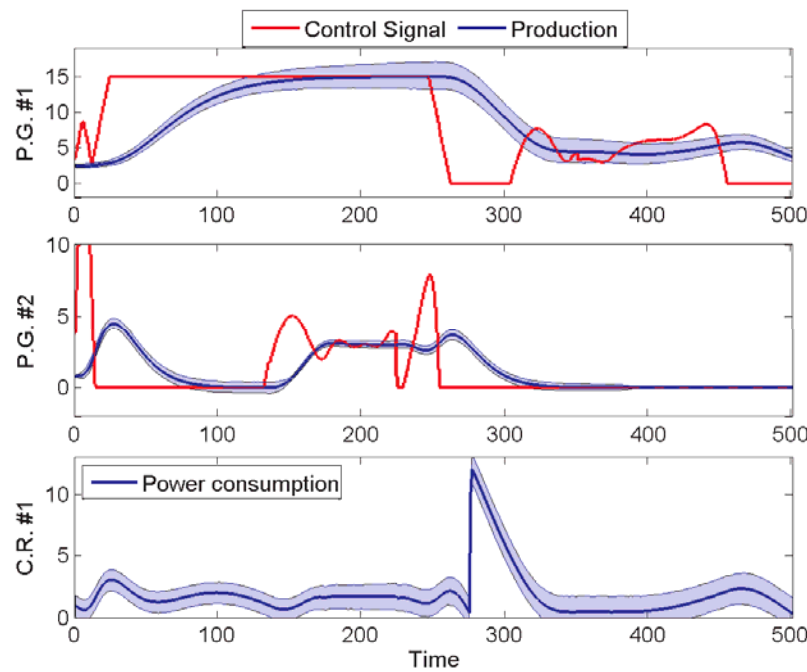

Overall setup

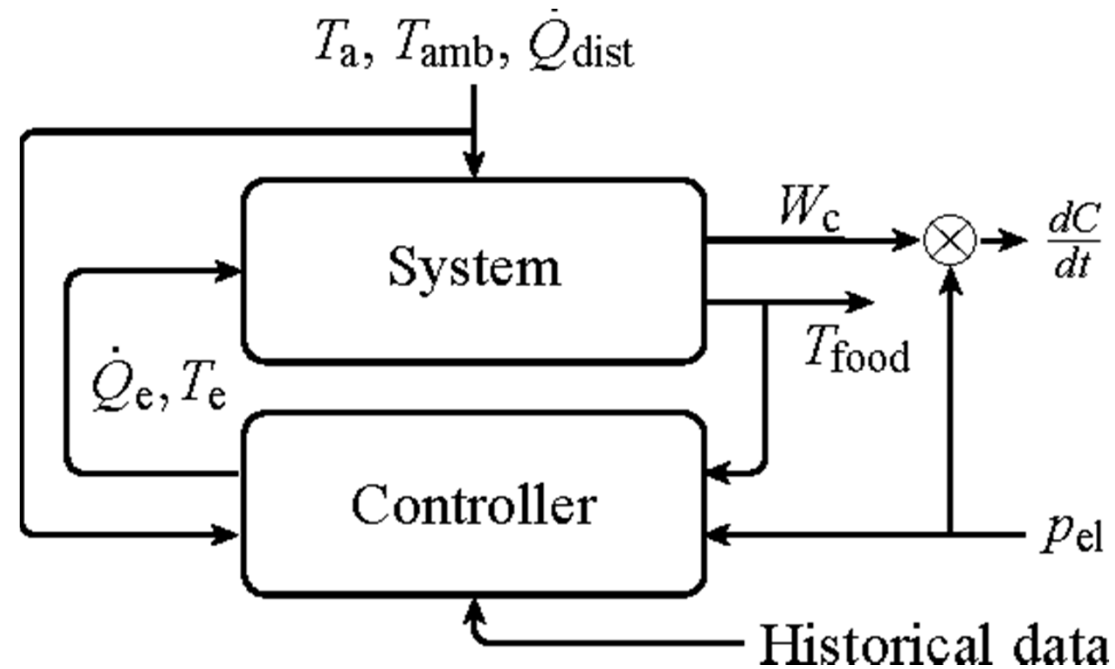

Simulations:

- Covering a full year (2010).
- Outdoor temperature from Denmark.
- Electricity prices from Nordpool.
- Uncertain heat load disturbances and thermal masses.
- Verified models from supermarket in operation in Denmark.

Implementation:

- Optimization problem solved iteratively
- Ultra fast solvers for real-time implementation.
- Soft constraints and back-off for robustness.
- Predictors trained on historical data (previous three years).

Temperature profile

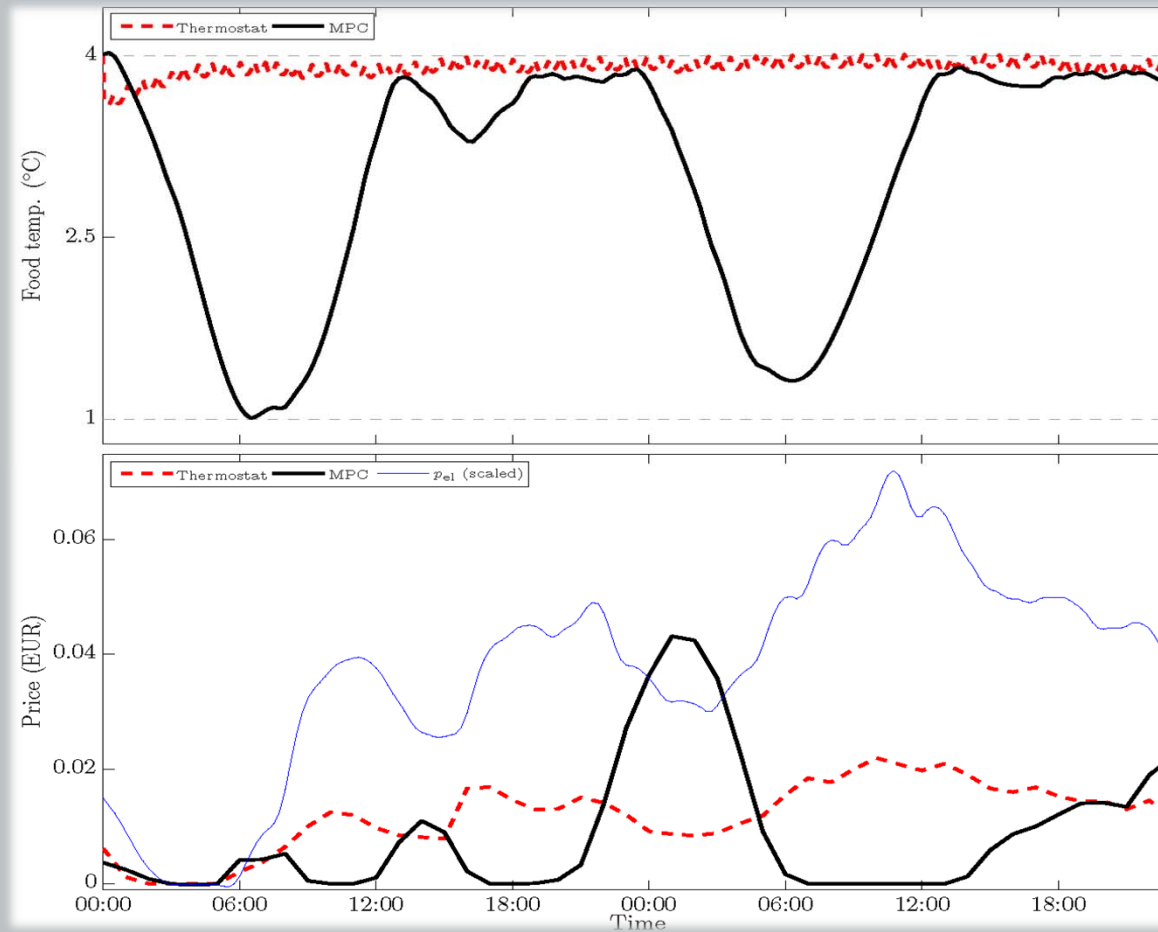

Demand response

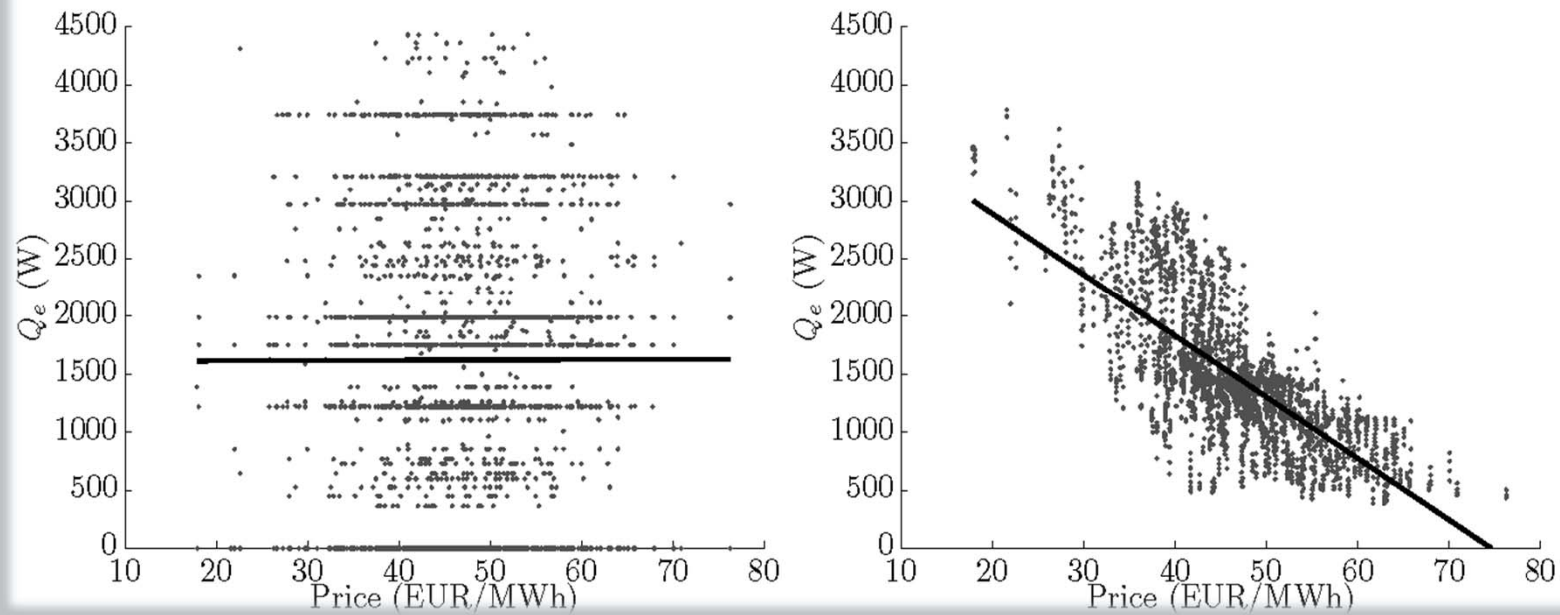

Temperature distributions

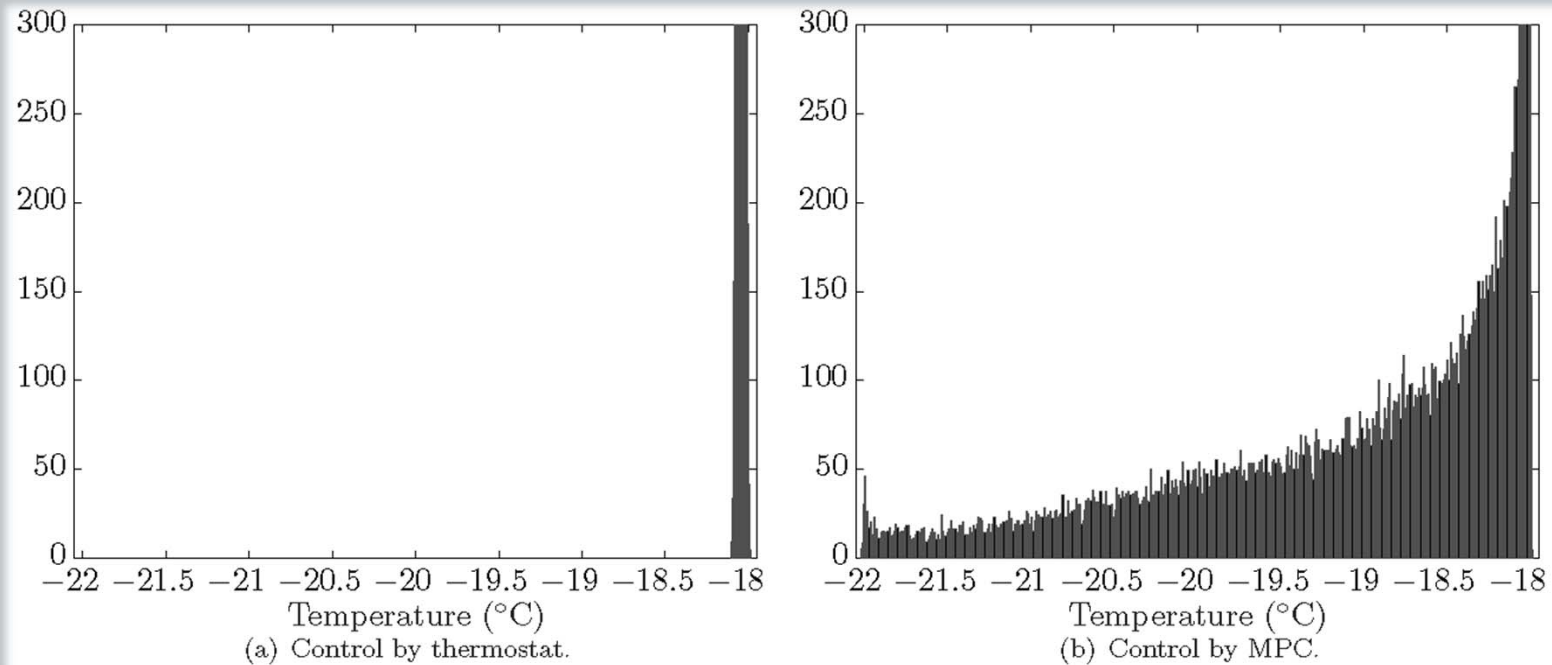

Price distributions

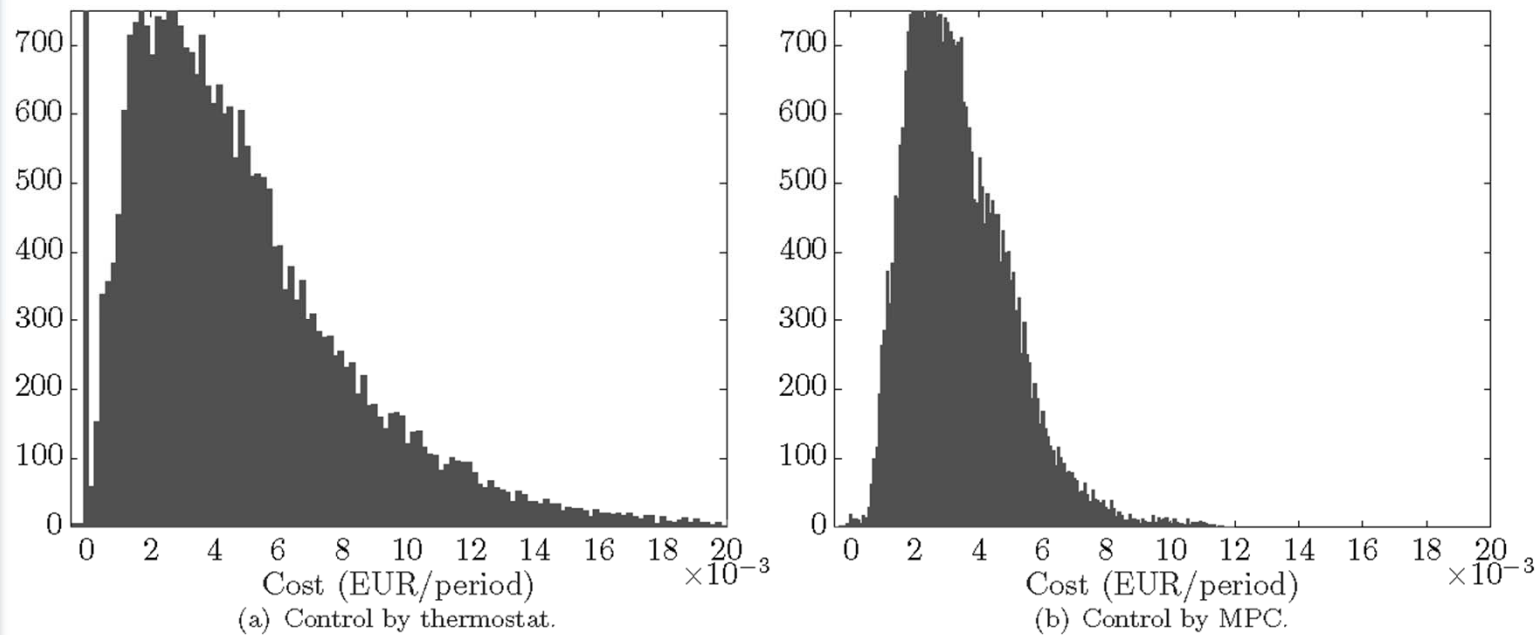

Key findings:

- Cost savings around 30 %
- Potential for additional savings by offering regulating power.
- Very simple predictors are sufficient.
- Prescient simulation improves total cost with less than 2%.
- Closed-loop performance is quite robust against variations in model parameters.

Additional results include:

- Robustness investigations:
 - Advanced method with known probability distributions for the uncertainty.
 - Simpler version with back-off tuned to make constraint violations very infrequent.
- Modeling of dynamical systems for optimization and MPC purposes.
- Analysis of “active thermal mass” in foodstuffs.
- Experiments, identification, and validation on real systems in the lab.
- Investigation of optimization methods for industrial applications:
 - Standard linear and non-linear solvers.
 - Simplified problem formulations for linear solvers.
 - Dedicated fast embedded optimization techniques.

Co-control of wind power plant and flexible power consumers:

- We prove a potential for combining
 - wind speed forecasts,
 - control of wind turbines
 - and control of flexible power consumers (e.g. chains of supermarkets).
- Goals:
 - Improve integrability (grid friendliness) of wind power to the grid.
 - Obey tight grid codes.
 - Reject disturbances from wind speed changes with minimal power loss.
 - Avoid expensive energy storage solutions.

Co-control of wind power plant and flexible power consumers:

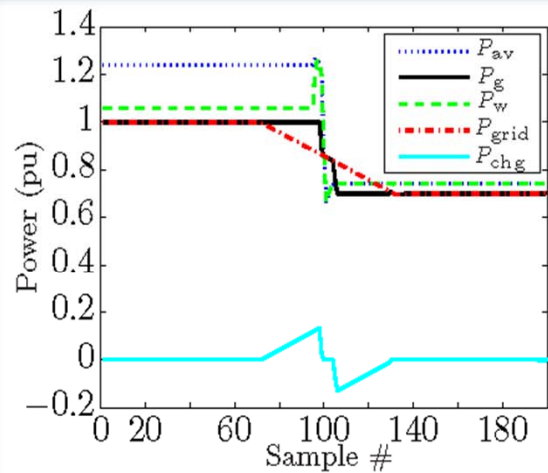

(a) Power flows normalized by P_{rated} .

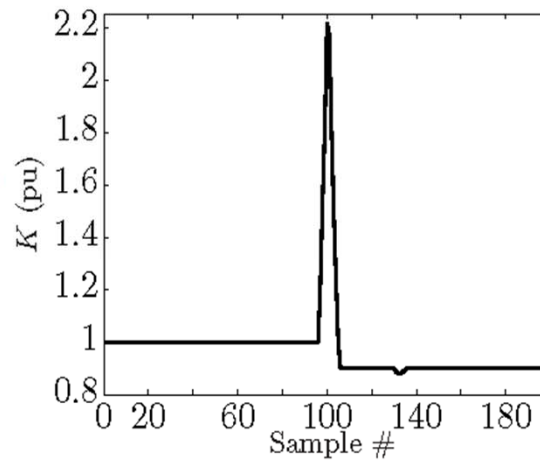

(b) Kinetic energy, $K(t)/K_{\text{rated}}$.

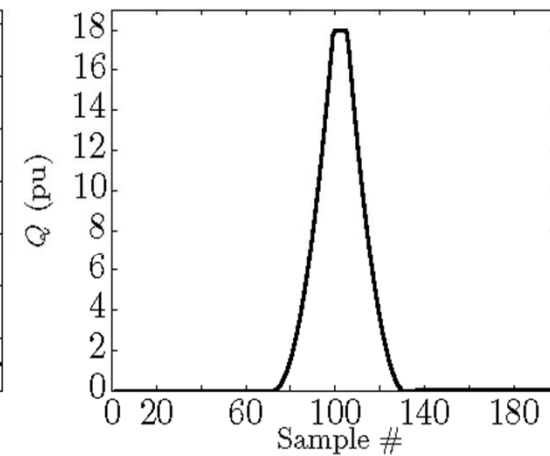

(c) State of charge, $Q(t)/P_{\text{rated}}$.

Co-control of wind power plant and flexible power consumers:

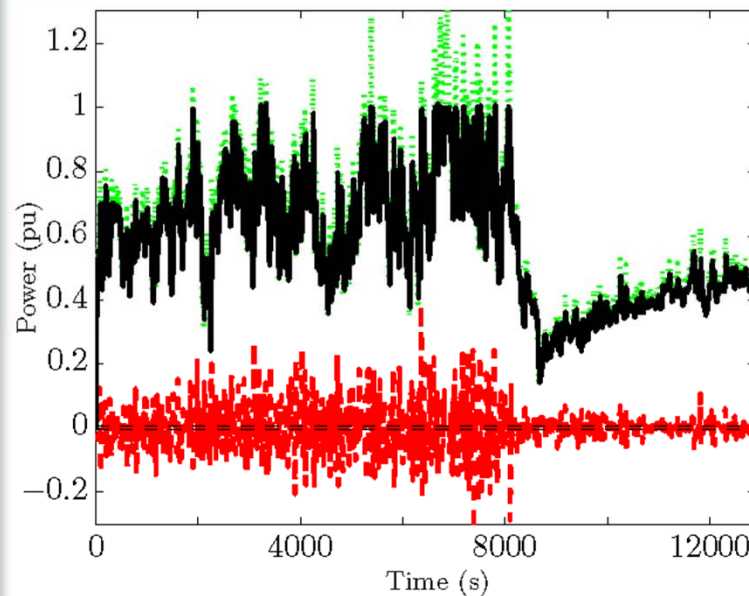

(c) Nominal controller: P_{grid} (solid black), $\max P_{\text{av}}$ (dotted green), and $\Delta P_{\text{grid}}/\text{sample}$ (dashed red).

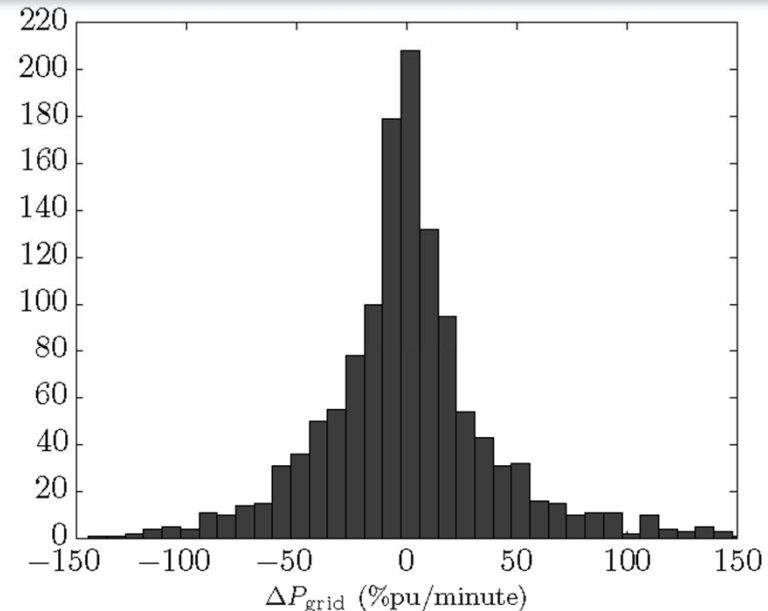

(d) Nominal controller: Power gradient in per cent of rated power per minute.

Nominal controller with real wind scenario

Co-control of wind power plant and flexible power consumers:

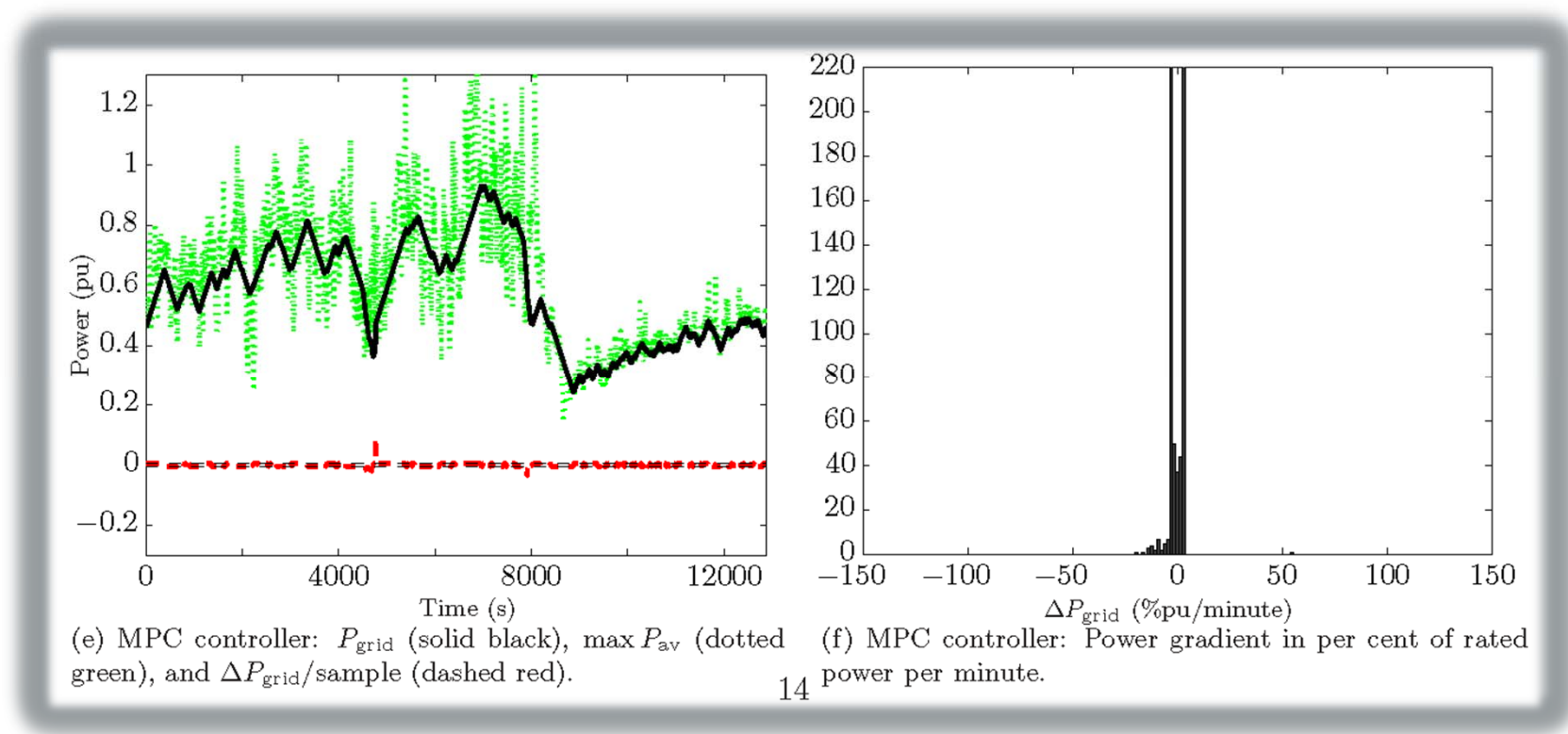

MPC controller with real wind scenario

Findings in project:

1. Investigations and proof-of-concept for flexible power consumption in industrial refrigeration by use of Economic MPC.
2. Enabling load-shifting strategies and regulating power services with significant cost reductions.
3. Challenges in MPC for industrial systems tackled:
 - Model accuracy, computational load, predictions, etc.
4. Synergy and co-control potential with wind energy revealed.

Some selected references:

1. Hovgaard, T.G., Larsen, L.F.S., Edlund, K. and Jørgensen, J.B. (2012). *Model predictive control technologies for efficient and flexible power consumption in refrigeration systems*. Energy 44(1), 105-116.
2. Hovgaard, T.G., Larsen, L.F.S., Jørgensen, J.B., and Boyd, S. (2013). *Nonconvex model predictive control for commercial refrigeration*. International Journal of Control. In press.
http://www.stanford.edu/~boyd/papers/noncvx_mpc_refr.html
3. Hovgaard, T.G., Boyd, S., and Jørgensen, J.B., (2013). *Model predictive control for wind power gradients*. Submitted to: International Journal of Control.
http://www.stanford.edu/~boyd/papers/wind_gradients_cvx.html

The Vestas logo is displayed in white, italicized font against a blue sky background with wispy clouds. The logo consists of the word "Vestas" followed by a registered trademark symbol (®).

Wind. It means the world to us.™

Thank you for your attention Questions?

The authors gratefully thank Danfoss Electronic Controls R&D, Refrigeration and Air-conditioning, Nordborgvej 81, DK-6430 Nordborg, Denmark for their contributions and support.

Copyright Notice

The documents are created by Vestas Wind Systems A/S and contain copyrighted material, trademarks, and other proprietary information. All rights reserved. No part of the documents may be reproduced or copied in any form or by any means - such as graphic, electronic, or mechanical, including photocopying, taping, or information storage and retrieval systems without the prior written permission of Vestas Wind Systems A/S. The use of these documents by you, or anyone else authorized by you, is prohibited unless specifically permitted by Vestas Wind Systems A/S. You may not alter or remove any trademark, copyright or other notice from the documents. The documents are provided "as is" and Vestas Wind Systems A/S shall not have any responsibility or liability whatsoever for the results of use of the documents by you.