



Developing an interface between MCNPX and McStas for simulation of neutron moderators to be applied at ESS

Lauritzen, Bent; Nonbøl, Erik; Klinkby, Esben Bryndt; Willendrup, Peter Kjær; Filges, Uwe

Publication date:
2013

Document Version
Publisher's PDF, also known as Version of record

[Link back to DTU Orbit](#)

Citation (APA):

Lauritzen, B., Nonbøl, E., Klinkby, E. B., Willendrup, P. K., & Filges, U. (2013). Developing an interface between MCNPX and McStas for simulation of neutron moderators to be applied at ESS. Sound/Visual production (digital)

General rights

Copyright and moral rights for the publications made accessible in the public portal are retained by the authors and/or other copyright owners and it is a condition of accessing publications that users recognise and abide by the legal requirements associated with these rights.

- Users may download and print one copy of any publication from the public portal for the purpose of private study or research.
- You may not further distribute the material or use it for any profit-making activity or commercial gain
- You may freely distribute the URL identifying the publication in the public portal

If you believe that this document breaches copyright please contact us providing details, and we will remove access to the work immediately and investigate your claim.

Developing an interface between MCNPX and McStas for simulation of neutron moderators to be applied at ESS

Bent Lauritzen
Erik Nonbøl
Esben Klinkby
Peter Willendrup
Uwe Filges

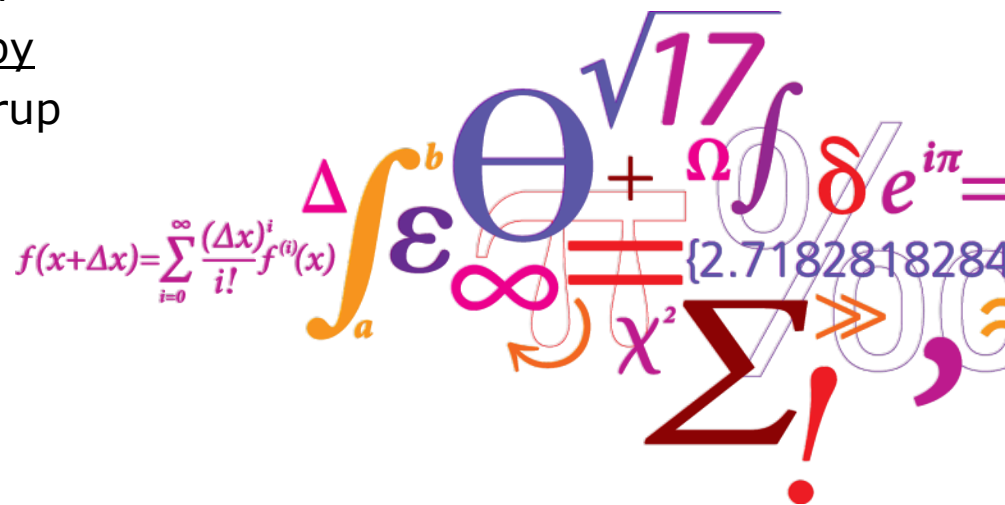

Outline

- **ESS concept**

- **McStas/MCNPX**

- **Explored interfaces between McStas/MCNPX**
 - Tally fit
 - Ptrac
 - SSW/SSR
 - Compile
 - Supermirror

- **Validation**
 - First results

- **Prospects**

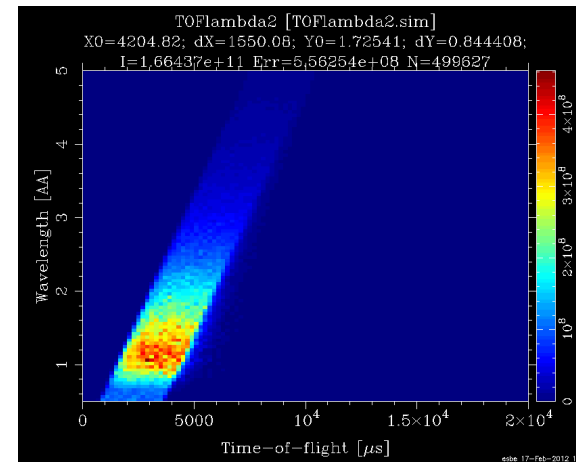

The ESS Headlines

- ESS will be the world's best source of slow neutrons by 2025
- ESS will produce its first neutrons in 2019
- ESS will cost 1479 M€₂₀₀₈ to construct



ESS will be different

- Sustainability & Environmental Responsibility
- Harness Innovations
- Excellent researcher support
- Person-centred
- Prepare for the future
- “More than simply neutrons”

ESS has got the Partners

Sweden, Denmark and Norway
50% of construction costs - 1479

17 Partners today

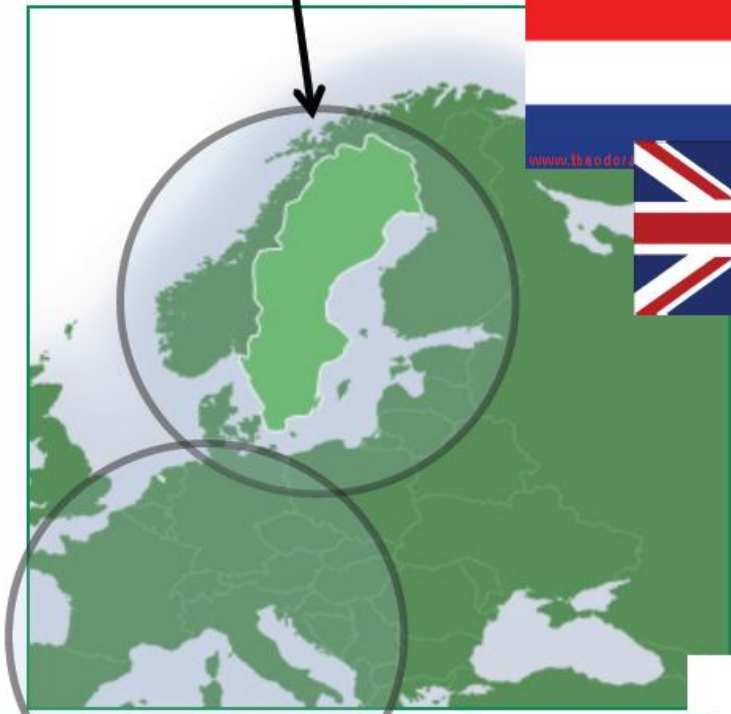

Spain,
Poland



Czech Republic,
Slovakia, Iceland & UK



the ... g 50%

The view to the South-East in 2025



ESS – some numbers

- Superconducting Proton Linear Accelerator
 - 2.5 GeV Proton Energy
- 50mA (2mA) peak (average) proton current
 - 357 kJ/pulse $9.1 \cdot 10^{14}$ protons/pulse
- 2.86 msec pulse length $4.0 \cdot 10^{16}$ neutrons/pulse
 - 14 Hz pulse frequency
- 71.4 msec periods between pulses
 - 5MW proton beam power
- Single Target Station
 - Rotating Tungsten, helium cooled
- 22 instruments
 - High reliability, low losses



1 metre

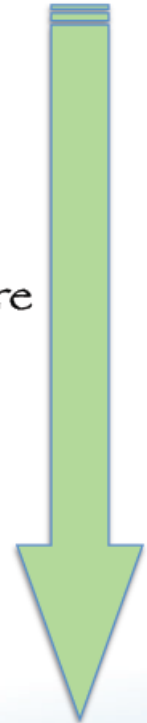

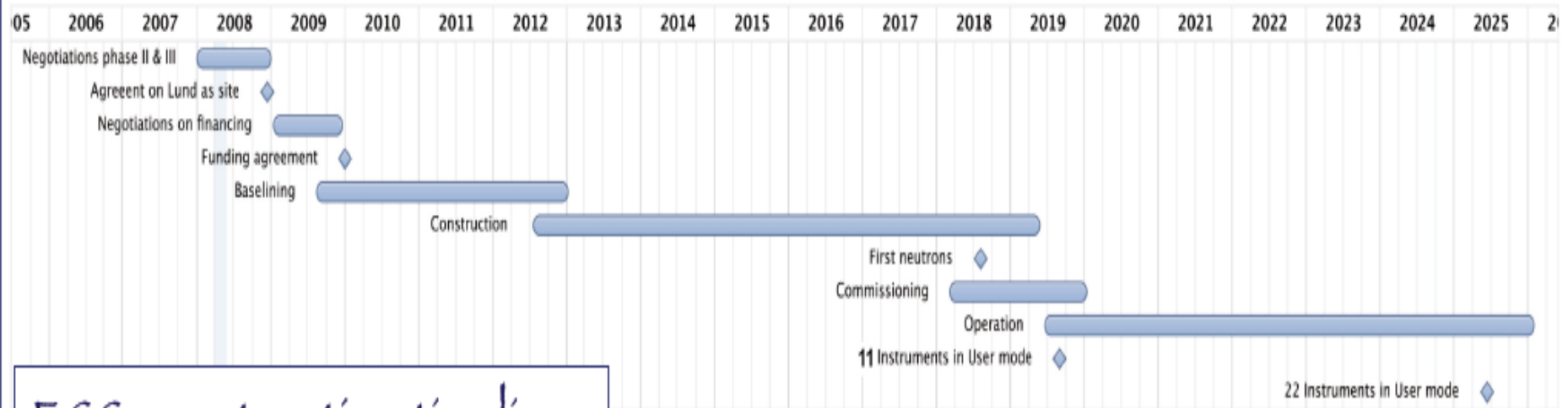

ESS construction timeline



EUROPEAN
SPALLATION
SOURCE

Target Station W/He/H₂

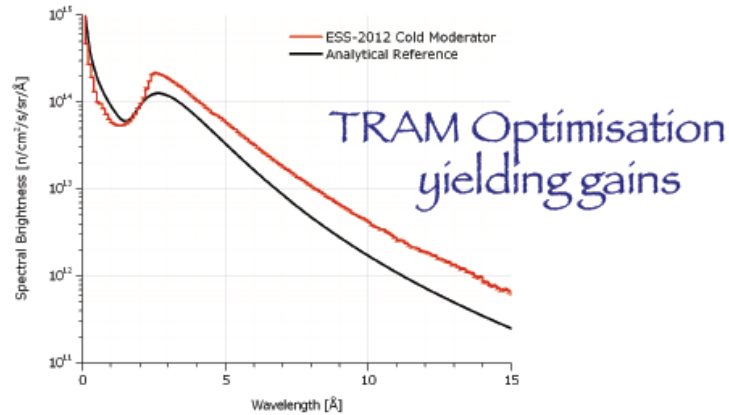

Target monolith during target change

Tungsten target wheel

Moderator-reflector plug

Accelerator proton beam window

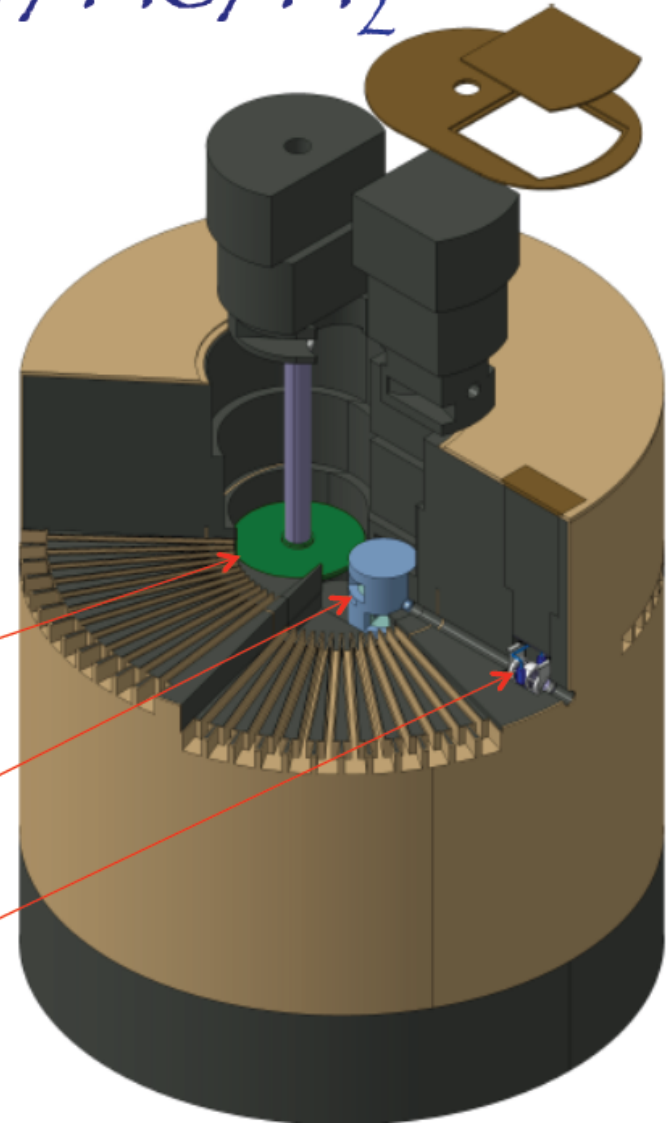

ESS design concepts

- *Scientific performance* is limited:
 - by the achievable *resolution*, which is limited:
 - by the *number neutrons* available $\sim 4 \times 10^{16}$ n/pulse
- 5MW proton beam power, ensures that the ESS is “top of the pops”
- Question: How to cool 5MW hitting $\sim 6\text{mm}^2$?
- Answer : Helium cooled, rotation tungsten wheel.

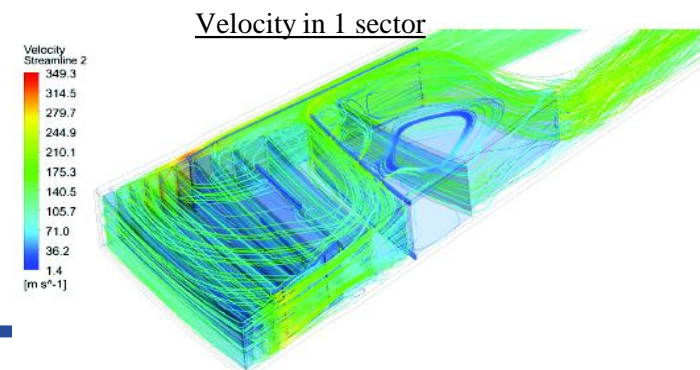
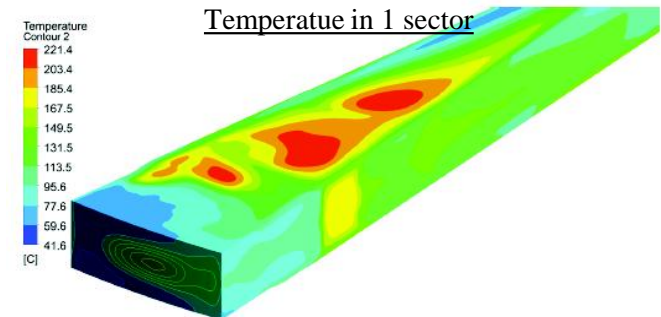
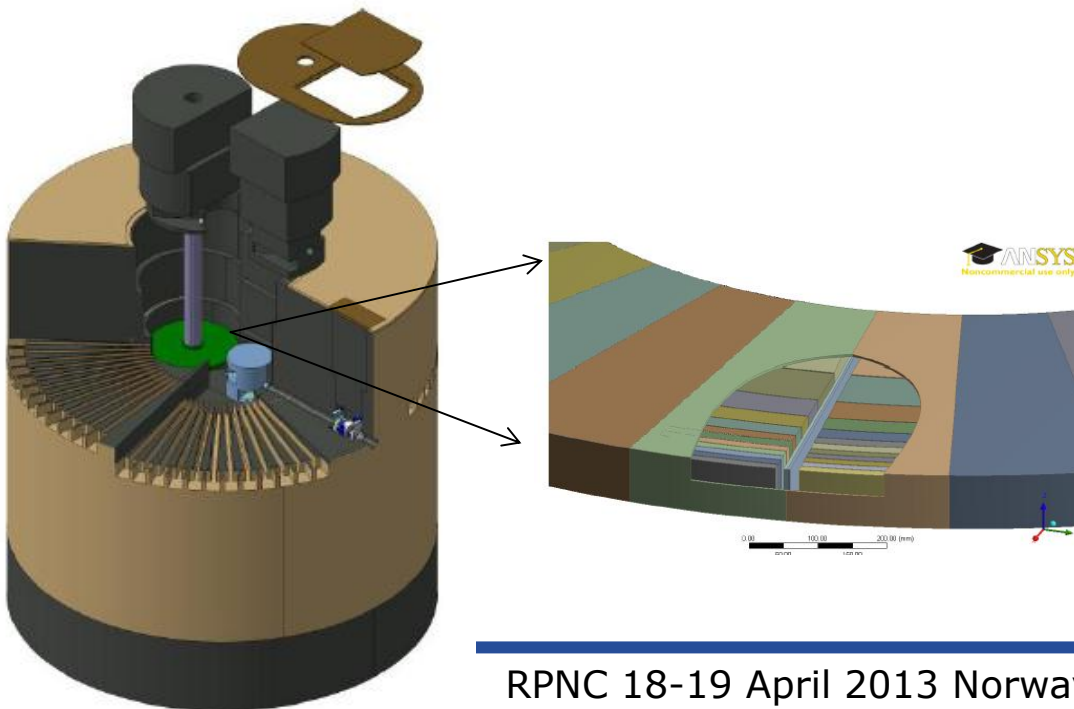

ESS Target station: Monolith

Monolith:
7000 t, 12 x 10 m

Target wheel (7 t, replaced every ~ 5 y)
Diameter 1.5 m, rotating 30 rpm

Moderator-reflector plug (10 t, replaced every ~ 1 y, shown in position ready for vertical extraction)

Accelerator proton beam window
(replaced every ~ 6 months)

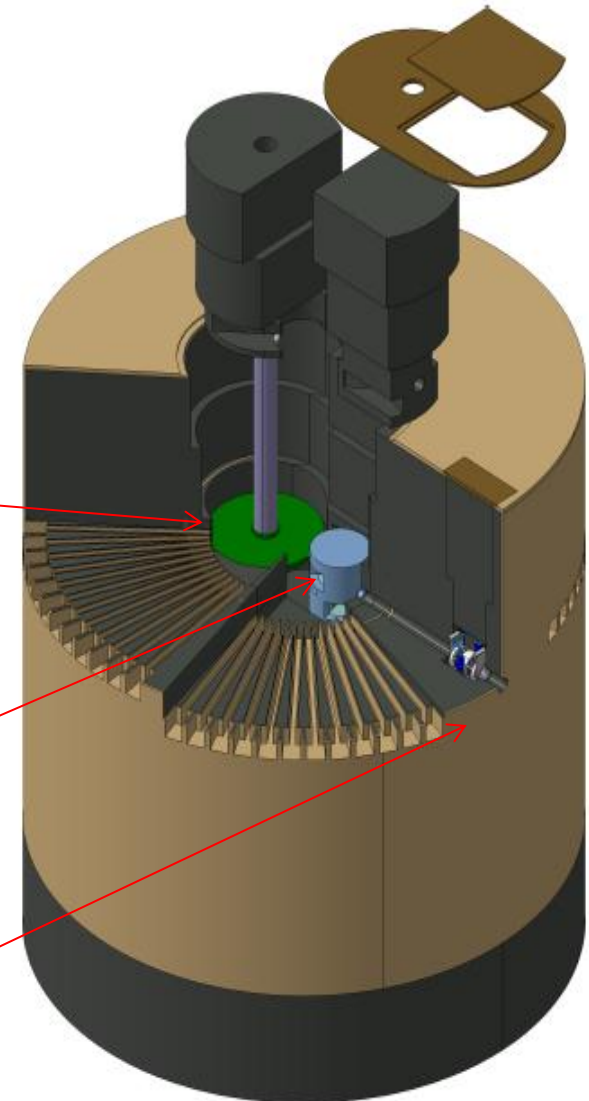

General layout of shielding monolith

Housing for target drive and bearing

Dimension according to current baseline

Access to PMR plug

Shutter drives

Proton beam

5° beam line separation

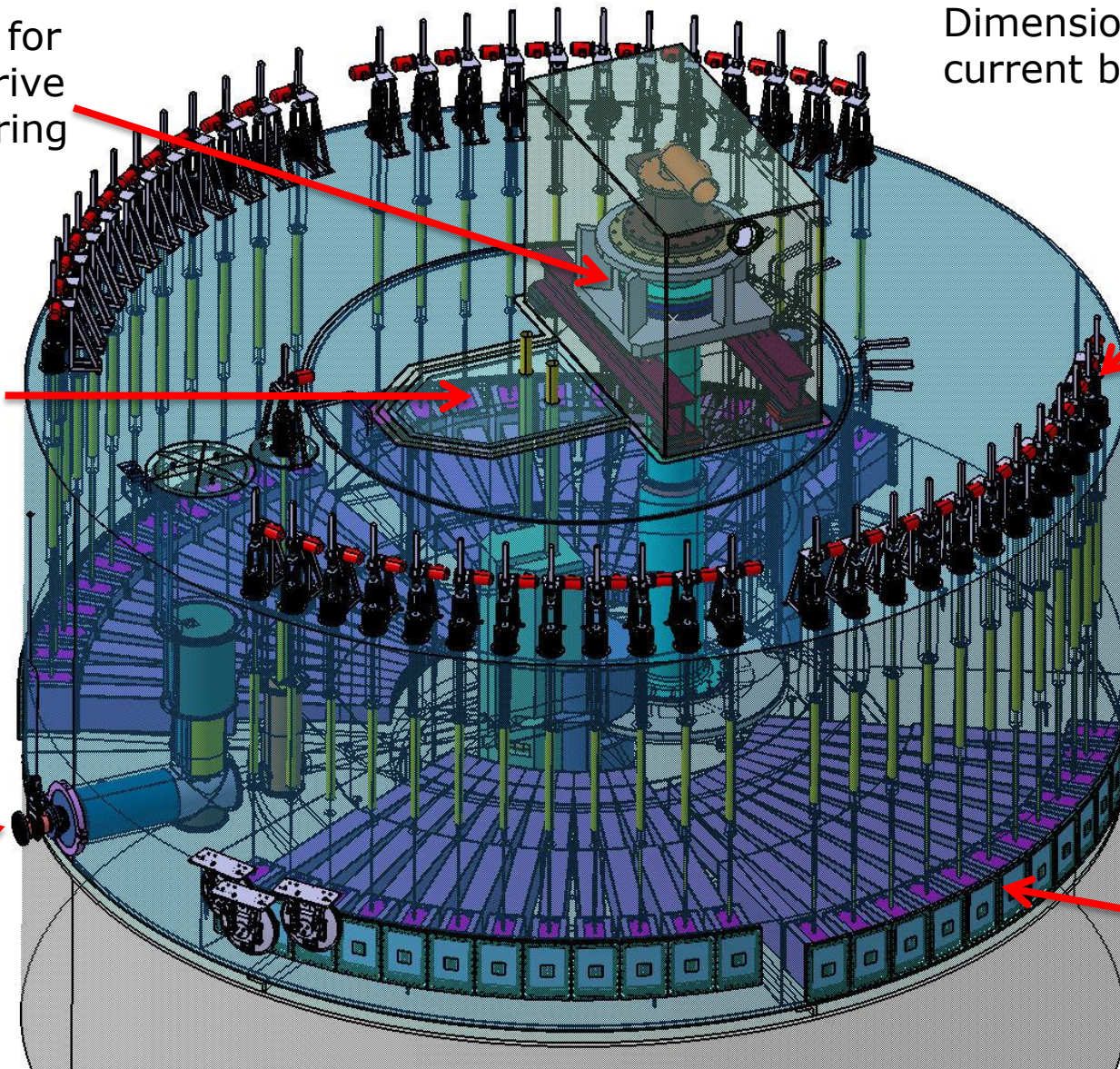

Target station design

Target station modeled with MCNPX

- Spallation takes place in rotating tungsten target
- The scale of the objects under study dictates the use of cold neutrons ($\sim 1-10\text{meV}$)
- Neutrons are moderated in H_2 and H_2O for cold and thermal neutrons

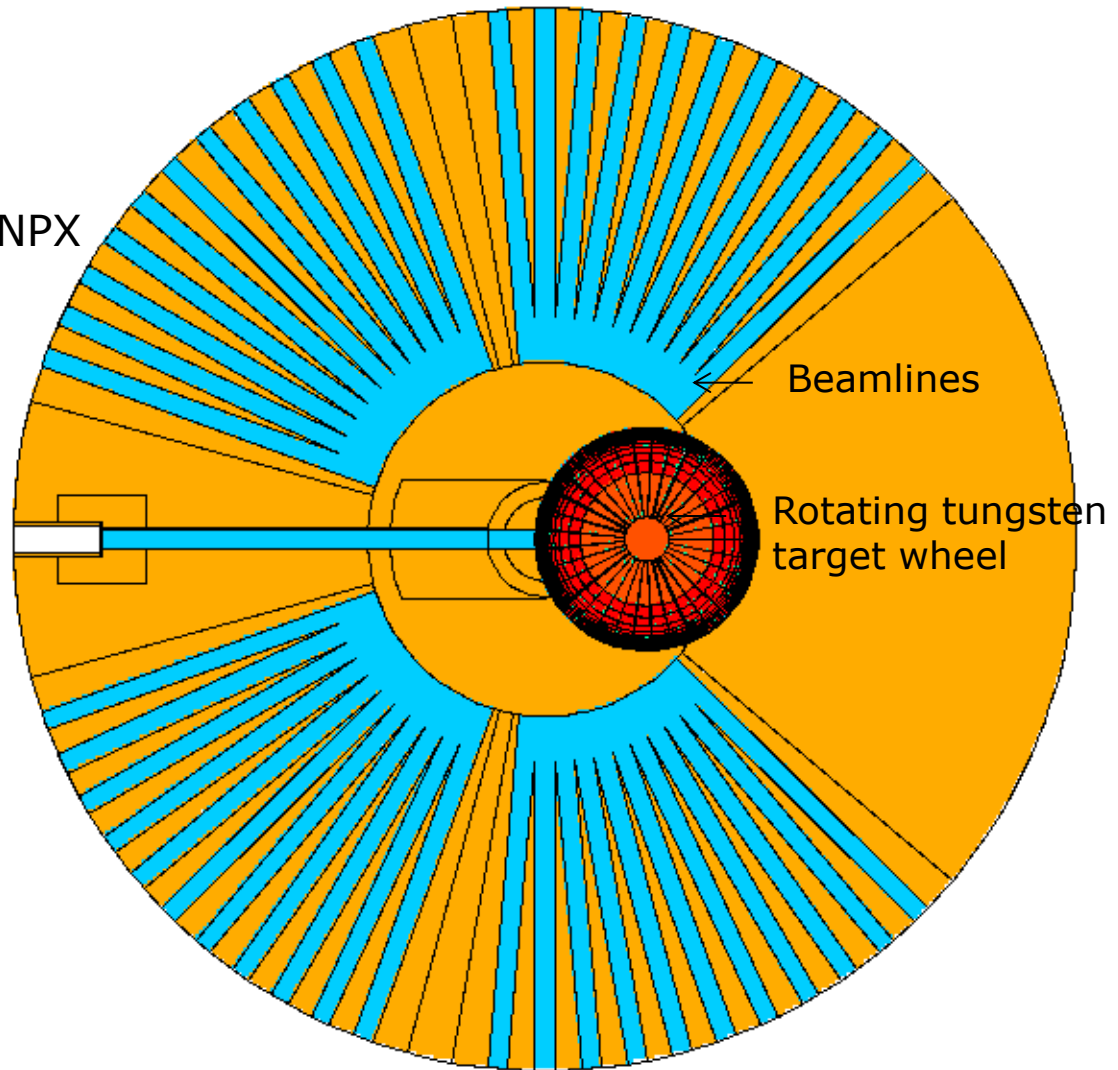

Target wheel spallation material	W
Target wheel coolant	He

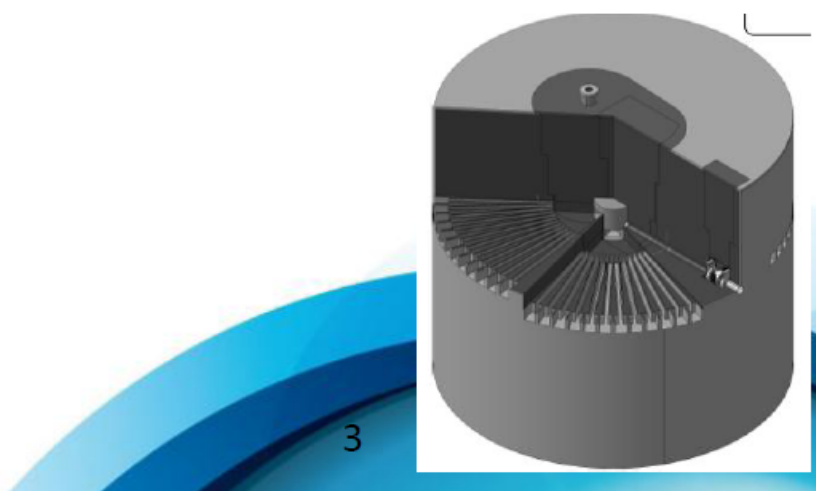
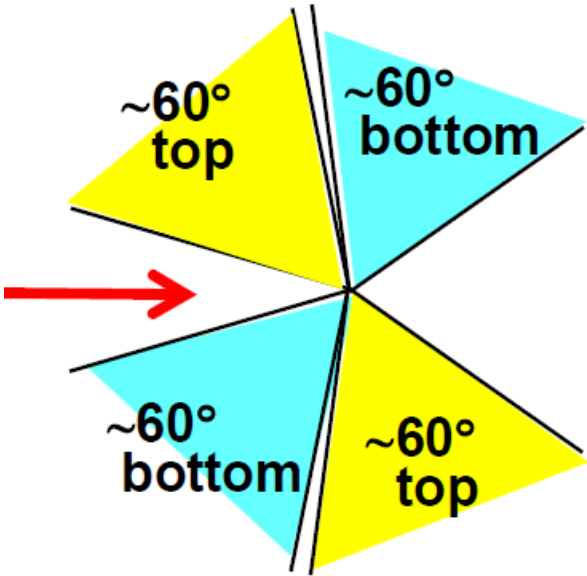
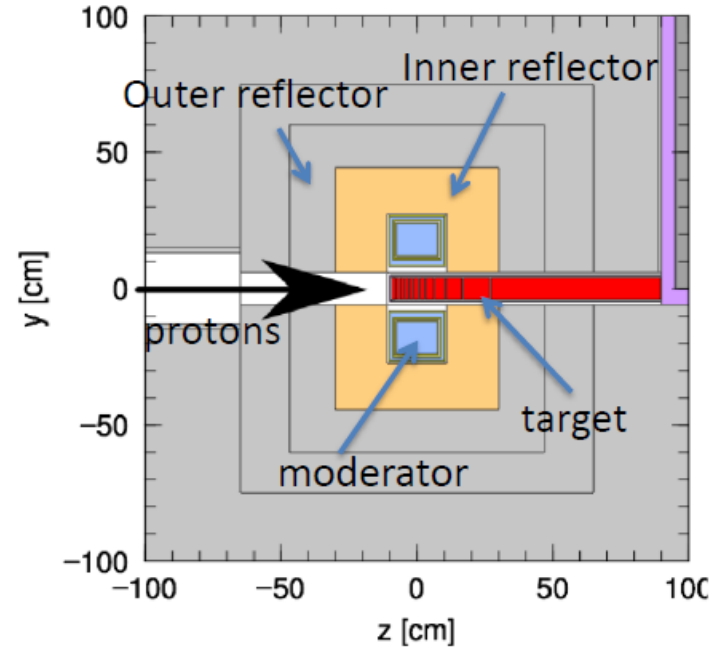
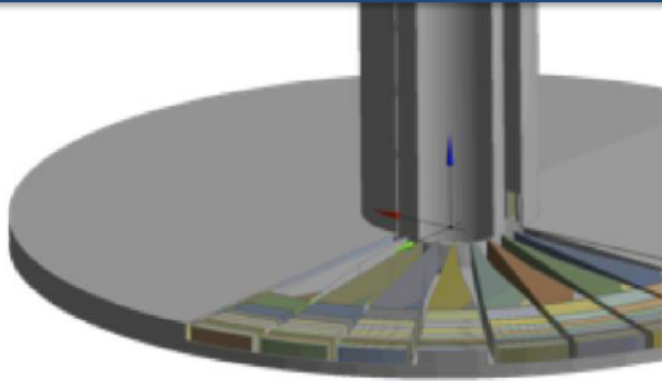

ESS design: target-moderator-reflector system

Bi-spectral moderator:
 H_2O thermal and liquid H_2 at 20 K

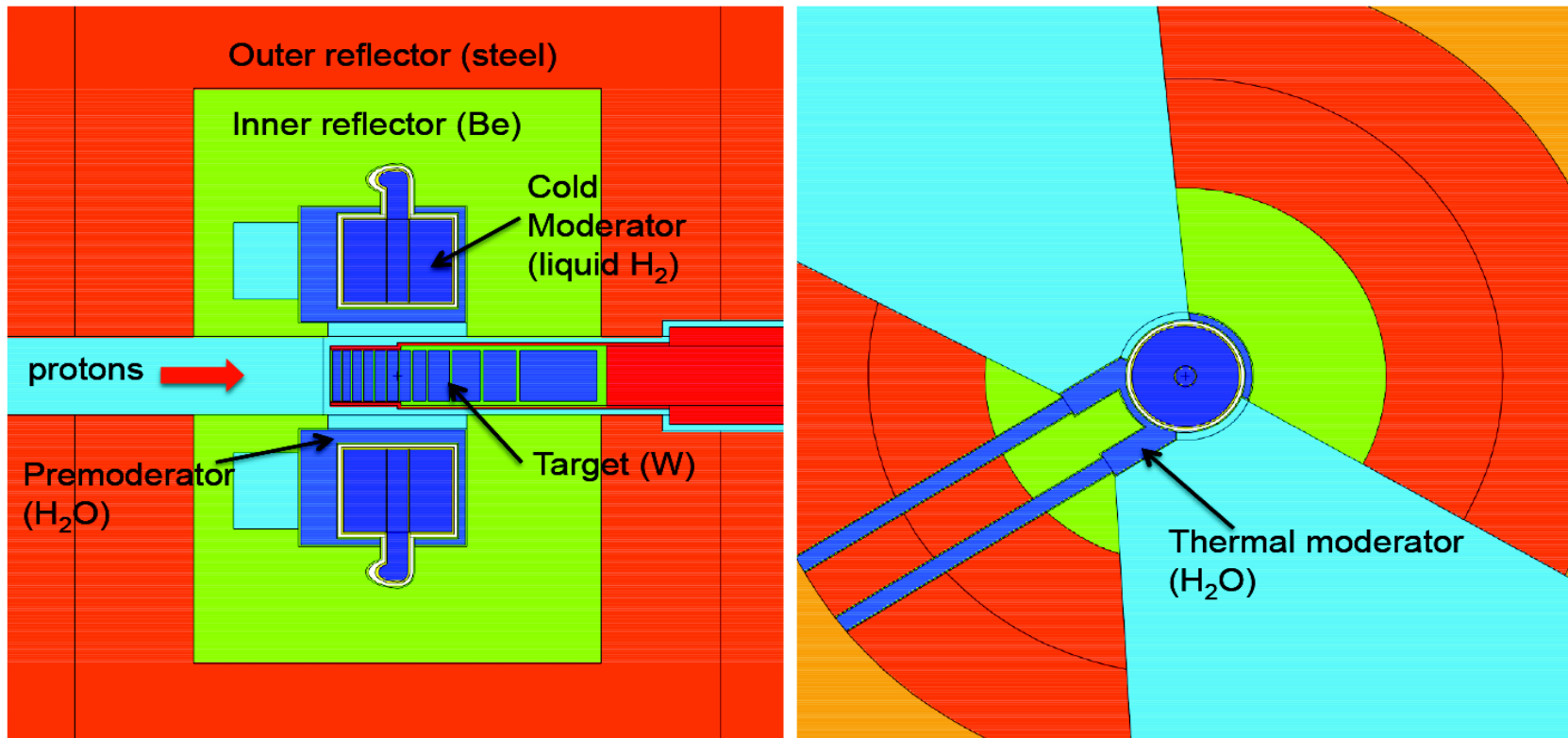

Outline

- ESS concept

- **McStas/MCNPX**

- Explored interfaces between McStas/MCNPX
 - Tally fit
 - Ptrac
 - SSW/SSR
 - Compile
 - Supermirror

- **Validation**
 - First results

- **Prospects**

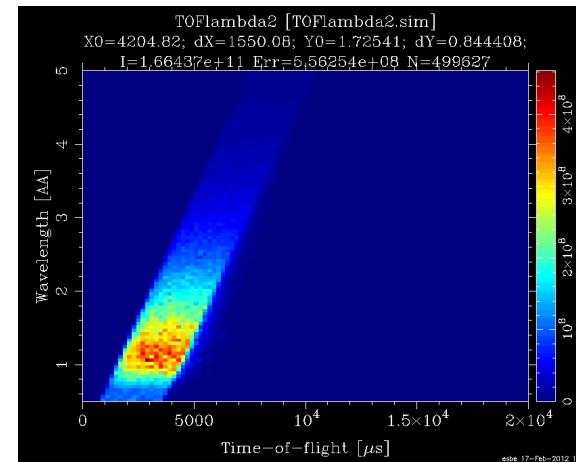

McStas Introduction

- Flexible, general simulation utility for neutron scattering experiments.
- Original design for Monte carlo Simulation of triple axis spectrometers
- Developed at RISØ DTU, KU, PSI and ILL, Grenoble.
- V. 1.0 by K Nielsen & K Lefmann (1998)
- Currently 2.5+1 people full time plus students



GNU GPL License
Open Source

Project website at

<http://www.mcstas.org>

neutron-mc@risoe.dk mailinglist

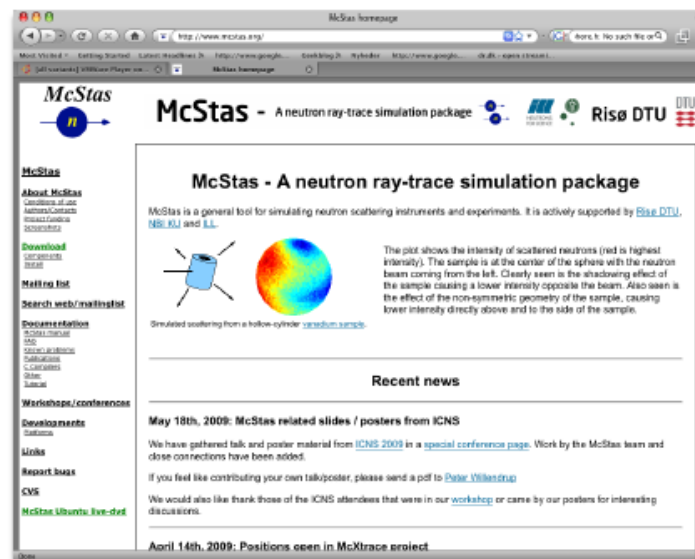

- Synergy, knowledge transfer, shared infrastructure

McStas Introduction

- Used at all major neutron sources (or instrumentation efforts)



World leading in neutron Monte Carlo
McStas



What is McStas used for?

- Instrumentation
- Virtual experiments
- Data analysis
- Teaching

(KU 2005-2011)

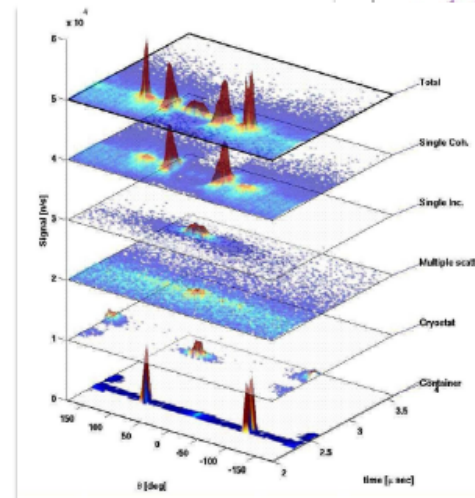
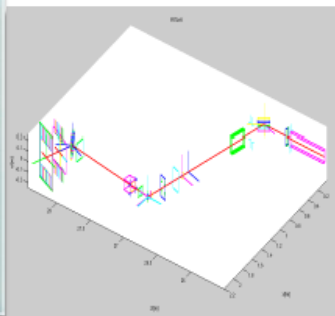
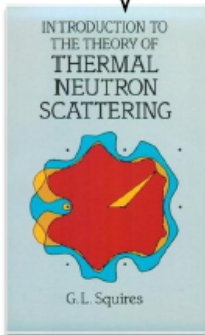
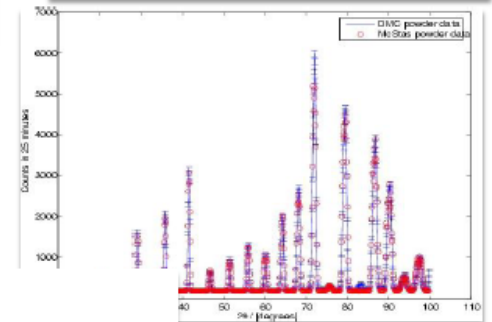
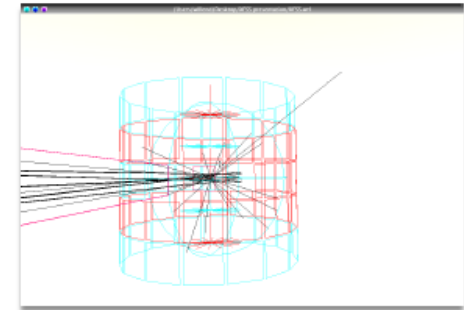
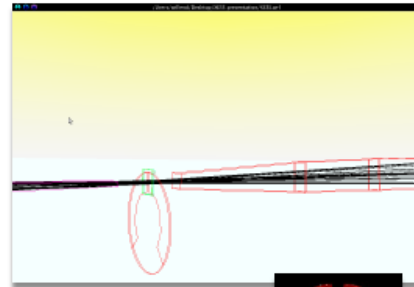

A few facts about physics in McStas

- Under usual circumstances, the **source** for us effectively means **the moderator surface**
- Moderator described via analytical expressions of neutron velocities etc. (fitted spectra) or or direct input of events via tally-ptrac files from MCNP/X (or similar in case of Tripoli4)
- Our neutrons are typically “statistical events” meaning not single neutron particles, but rather “**neutron rays**” with a given weight
- Cold and thermal neutrons are described *very* well, including
 - **Coherent** and incoherent scattering (possibility to move particle<->wave)
 - Elastic and inelastic scattering
- Structure and dynamical properties of matter in different states are well described, e.g. liquids/amorpheus, powders, single crystals, small angle scattering
- We handle structures of “any shape”

MCNP/X and related codes, “shortcomings”

(- for our use: effective production of cold-thermal neutrons)

- Mainly focused on high energy neutrons (extrapolations apply in many cases)
- Coherent scattering (Bragg etc.) from atomic planes is not implemented.
- -> Accurate simulation of alternatives for e.g. geometry and materials that interact with the moderated neutrons is currently not possible.

Reasons for interfacing MCNPX and McStas 1(2)

- Simulations of target-moderator-reflector systems at spallation sources are normally carried out with Monte Carlo codes such as MCNPX. Neutrons are slowed down from being fast at formation in the spallation target to thermal or cold at the beam extraction guides
- Since MCNPX is mainly used for fast and thermal neutrons it lacks description of coherent scattering (neutron wave interaction with crystal planes) being important at cold conditions (20 K)
- Simulations of neutron transport from moderator through beamlines to instruments are performed by ray tracing codes like McStas allowing for coherent scattering
- Coupling of the 2 codes typically is obtained by analytical fits of MCNPX neutron spectra at the moderator surface to McStas. It has been done with success but has the limitation not to allow re-entrance of neutrons to the MCNPX regime

Reasons for interfacing MCNPX and McStas 2(2)

- A more direct coupling is necessary for accurate simulation of e.g.
 - complex moderator geometry
 - gamma background radiation in and along beamlines and near instruments
 - interference between beamlines
 - shielding requirements along neutron guides

Simulations which all demand possibility for re-entrance of neutrons from McStas to MCNPX for calculating absorption of neutrons and gamma production along the beamlines

Below will be shown different approaches for a more direct coupling between the codes

Outline

- ESS concept
- McStas/MCNPX
- **Explored interfaces between McStas/MCNPX**
 - Tally fit
 - Ptrac
 - SSW/SSR
 - Compile
 - Supermirror
- **Validation**
 - First results
- **Prospects**

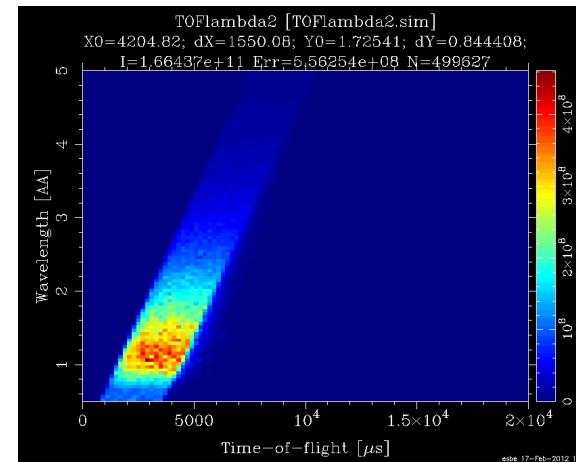

Tally fitting (present default approach)

1. Neutron spectrum calculated with MCNPX at the moderator surface
2. Spectrum is approximated by Maxwellian fits which serves as input to McStas.



Con's

- Correlations (e.g. E, pos, angles) unaccounted for
- Write out at 1 surface only
- No re-entry (format is write-only)



Pro's

- Fast - MCNPX calculation done once-and-for-all
- Avoids licensing issues

Ptrac

- MCNPX can output an ascii file containing individual neutron states: pos, angles, energy, time & weight
- The McStas component: *MCNP_Virtual_Input* converts the neutron state into McStas readable and works as a source



Con's

- ascii file enormous: ~0.2kB/evt
- Write out at 1 surface only
- No re-entry (format is write-only)
- Cannot run MPI



Pro's

- Correlations conserved (e.g. E,pos)
- Fast

```

Ptrac format
.....
3000      2      10      179
100       2       0
          0.00000E+00 0.28640E+00
0.43531E+00 -0.10000E+01
0.00000E+00 0.00000E+00
0.10000E+00 0.10000E+01
0.33356E-02
          3000      3      110      179
10        2       0
          -0.20000E+00 0.28640E+00
0.43531E+00 -0.10000E+01
0.00000E+00 0.00000E+00
0.10000E+00 0.10000E+01
0.40028E-02
          3000      4      120      179
100       2       0
          -0.40000E+00 0.28640E+00
0.43531E+00 -0.10000E+01
0.00000E+00 0.00000E+00
0.10000E+00 0.10000E+01
0.46699E-02
          3000      5      130      179
.....

```

SSW/SSR

- **S**ource **S**urface **W**rite/**R**ead in MCNPX stops/starts simulations at a given (set of) surface(s)
- The neutron state is written to binary file (SSW) on these surfaces when stopped. MCNPX can later continue the simulation by reading SSW=(SSR) and use it as source
- New McStas components:
 - ➔ *MCNP_Virtual_ss_Input* & *MCNP_Virtual_ss_Output* read MCNPX output(SSW), perform McStas calculation and write SSW to be read by MCNPX input(SSR)
 - Neutron propagation started in MCNPX, continued in McStas is finalizing in MCNPX

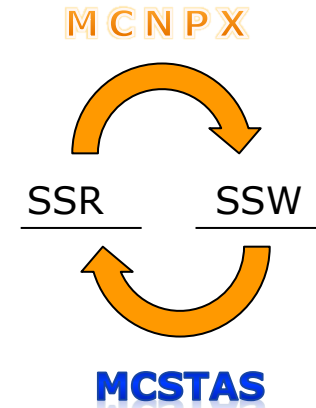



Binary file

- Write out at selected surfaces only
- Has not (yet) been tested with MPI



All McStas functionality usable

- Re-entry supported
- Correlations conserved (e.g. E,pos)

Combined compilation

METHOD

- McStas surface flag introduced in MCNPX
- Neutron crossing McStas surface causes initiation of McStas simulation, based on neutron state.
- Updated neutron state returned to MCNPX

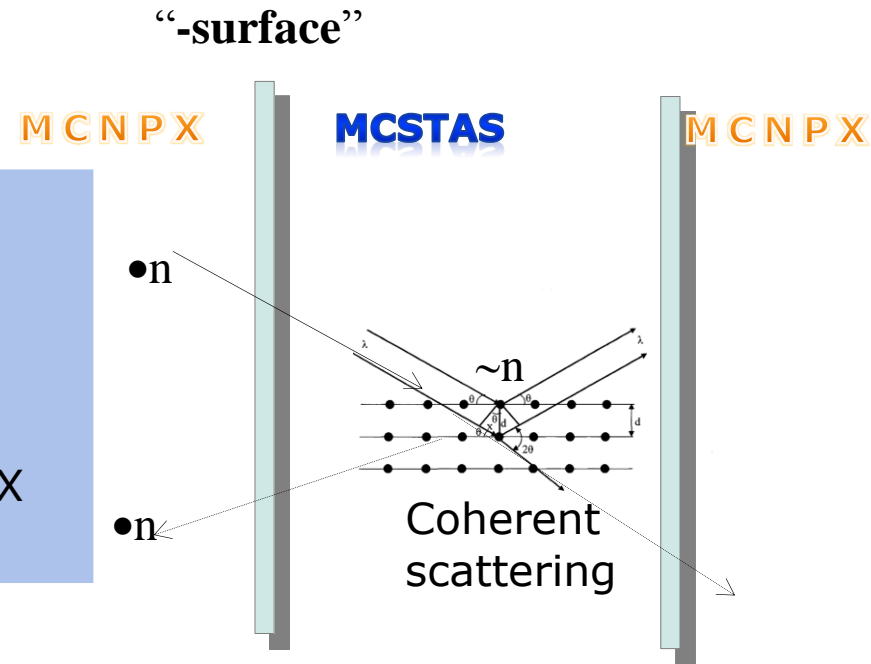

in MCNPX input file:

```

.....
-110 PX -0.2
-120 PX -0.4
.....

```



Technically difficult to make general

- Licensing issue
- Slow: MCNPX called for each neutron



Potentially very flexible (but not yet fully developed)

- All McStas functionality usable
- Re-entry supported
- Correlations conserved (e.g. E,pos)

Supermirror

➤ Existing implementation, introducing McStas inspired supermirrors as a surface card in MCNPX (Gallmeier et al, Nuc.Tech. 168(3))

➤ Reflectivity $R=R_0$ *if $Q < Q_c$*

➤ $R=R_0/2\{1- \tanh[(Q -mQ_c)/W]\}\{1-a(Q -Q_c)\}$ *if $Q > Q_c$*

➤ Ported to MCNPX 2.7, but not yet validated



Doesn't scale: workload per functionality significant. Only McStas mirrors ported

- Licensing issue



Re-entry supported

- Correlations conserved (e.g. E,pos)
- Avoids intermediate files and multiple codes

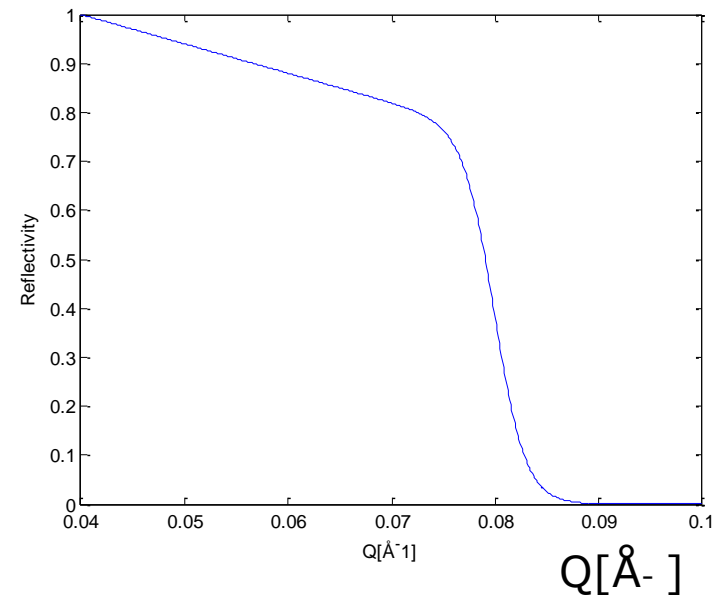

Cross comparison

	Re-entry neutrons	Speed	Single neutron trace	Require License	Comments
Tally	No	Fast*	No	Yes/No	Should try to determine validity at least once
Ptrac	No	Fast*	Yes	Yes	Somewhat outdated by SSW/SSR
SSW/SSR	Yes	Fast*	Yes	Yes	Promising...
Compile	Yes	Slow	Yes	Yes	Generalizes poorly (auto gen c-code hacks)
Supermirror	Yes	Slow	yes	yes	Generalizes poorly

*) The computational heavy MCNP/X calculation can be performed once-and-for-all

Outline

- ESS concept
- McStas/MCNPX
- Explored interfaces between McStas/MCNPX
 - Tally fit
 - Ptrac
 - SSW/SSR
 - Compile
 - Supermirror
- **Validation**
 - First results
- Prospects

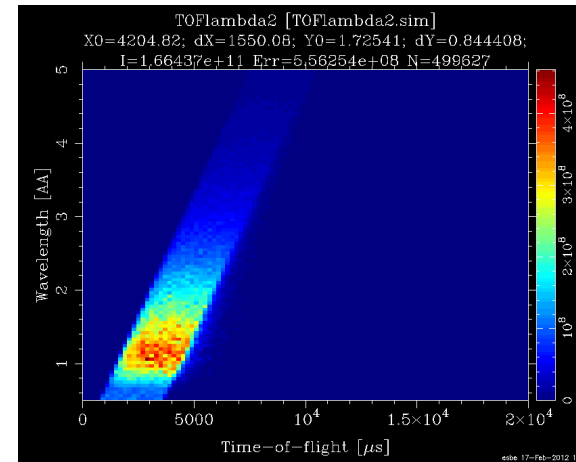

Validation setup

Strategy: consider dummy geometry, where the correct result is obvious:

- 20meV neutrons generated at disk and aimed 45 degree toward a perfectly reflecting 'guide wall' 1 cm away (in y)
- At z=4cm: check what comes through
- Assume vacuum in guide so that transport in McStas MCNPX should be identical

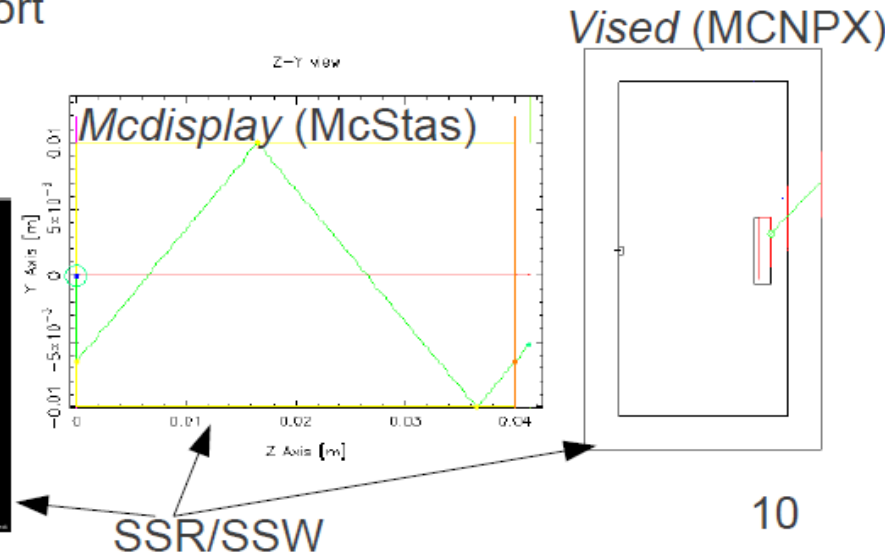
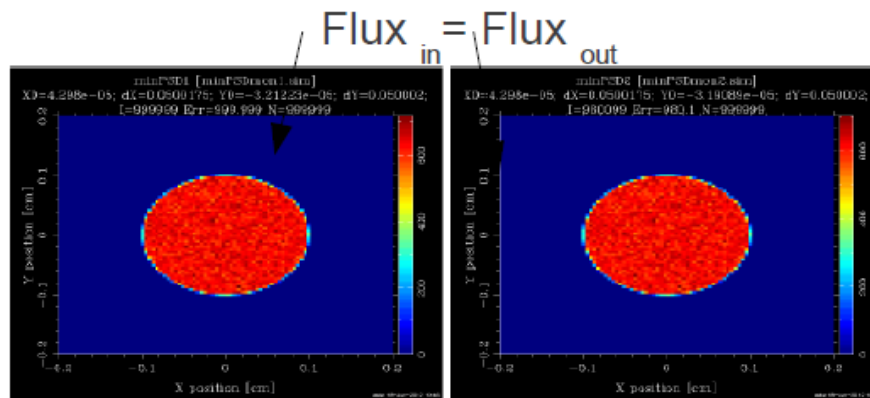
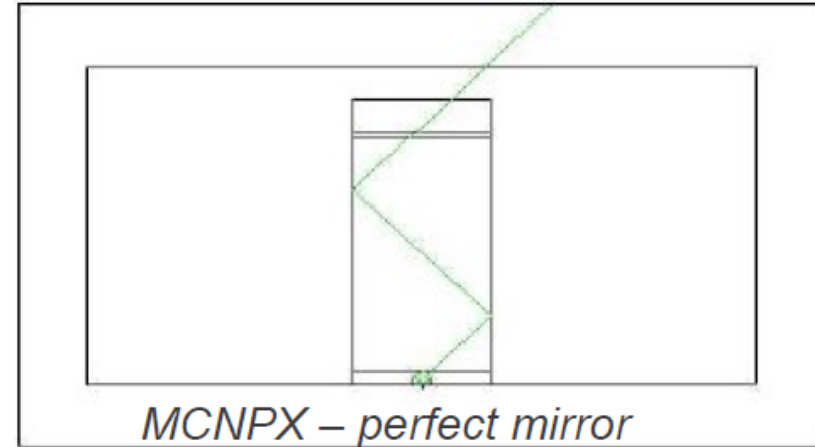

Validation results

Surface current at guide exit

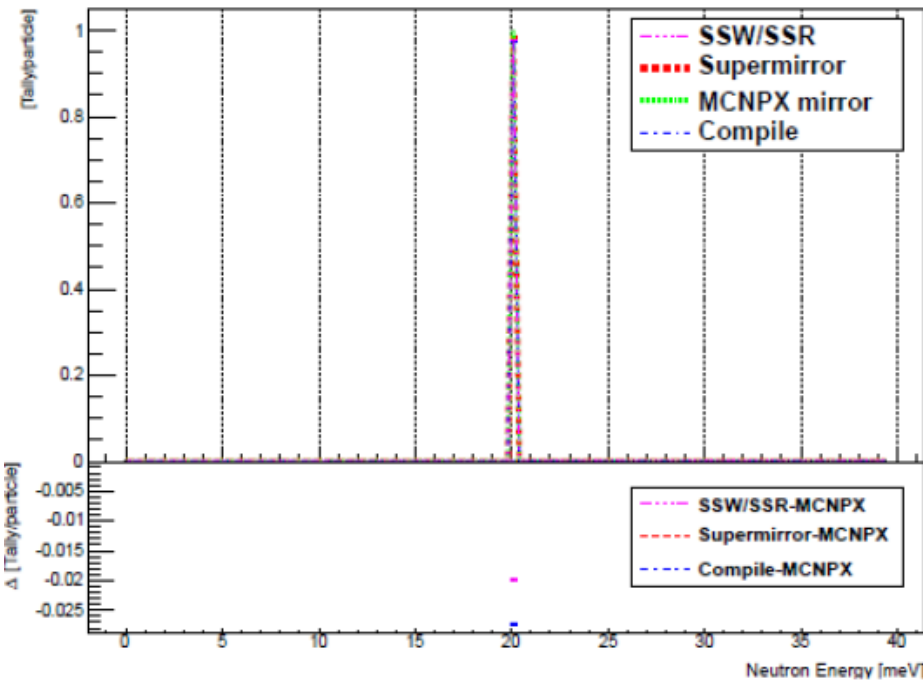

Surface current at guide exit

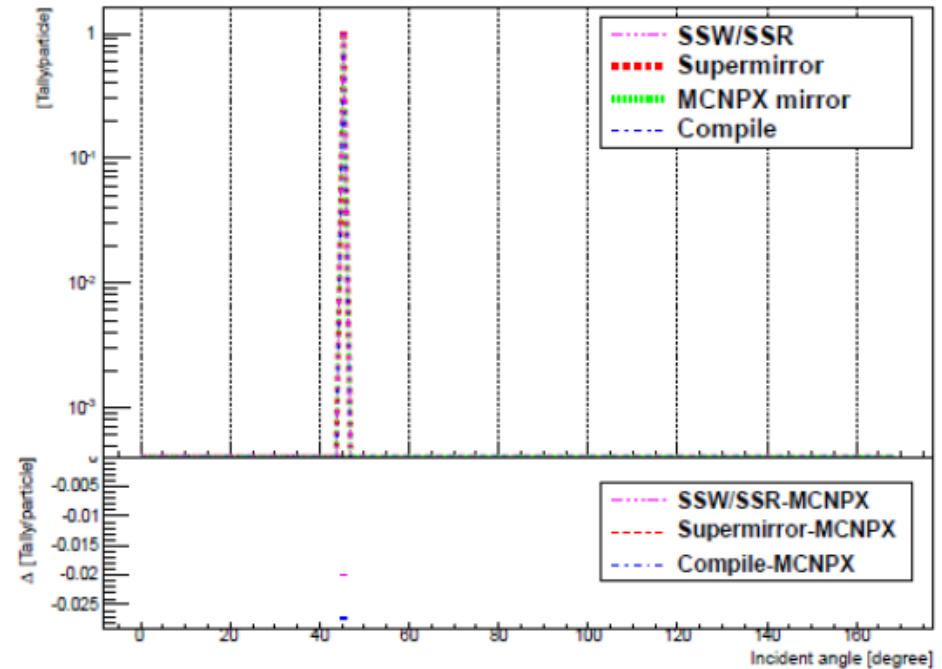

For all interfaces:

→ Neutron energy and angle conserved (45degree, scattered twice) ✓

Validation results

For fun: repeat after filling the guide with air

Surface current at guide exit

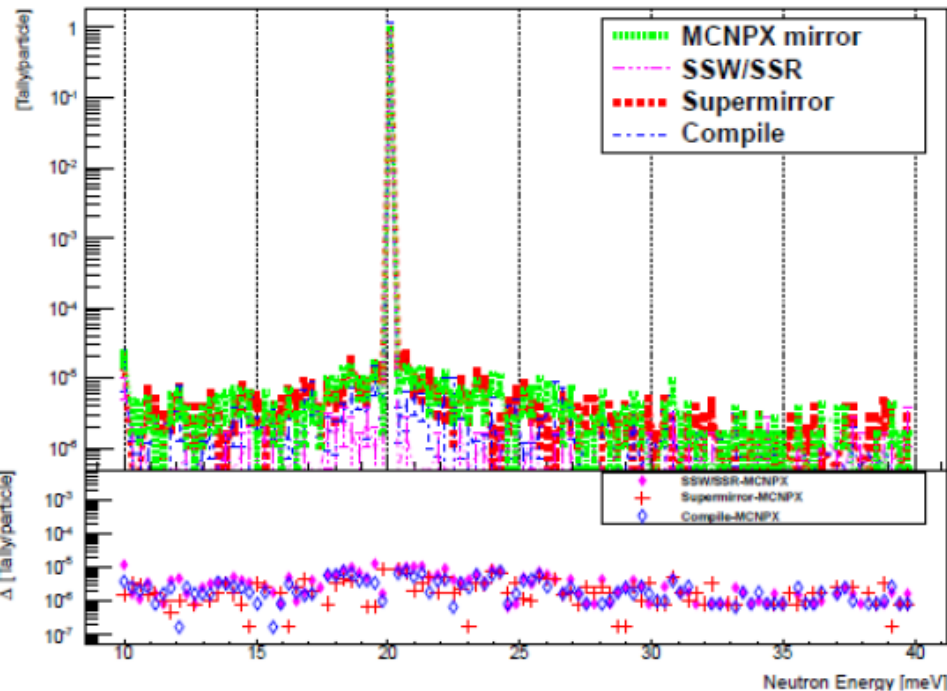

Surface current at guide exit

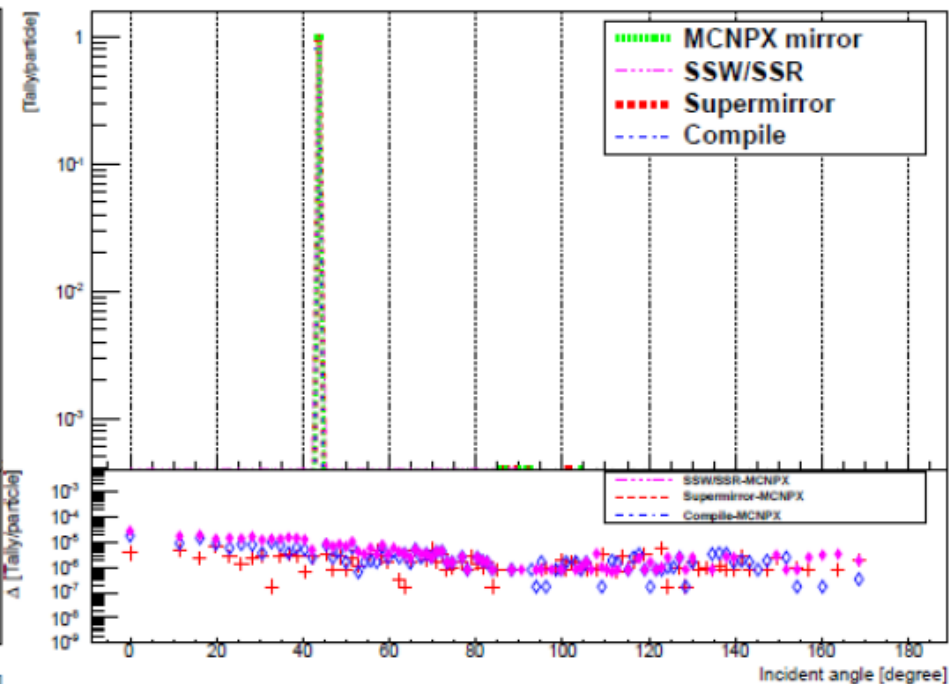

At first glance, the tails in SSW/SSR histograms surprised me. However, the tails are due to backscattering in the air outside the “McStas world”

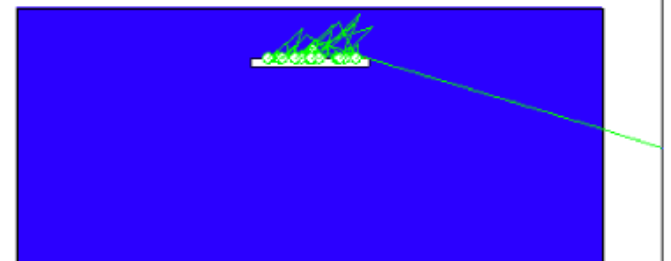

Prospects

- A preliminary validation of the MCNPX/McStas interface SSW/SSR, Compile and Supermirror has been made
- The validation will be continued with comparison between measurements and simulations at PSI
- The developed interfaces will be used for studying advanced moderator designs for ESS, where the intensity is, the moderator will be renewed every 1-2 years