



## Simulation-Based Planning of Optimal Conditions for Industrial Computed Tomography

Reisinger, S.; Kasperl, S.; Franz, M.; Hiller, Jochen; Schmid, U.

*Published in:*

International Symposium on Digital Industrial Radiology and Computed Tomography

*Publication date:*

2011

*Document Version*

Publisher's PDF, also known as Version of record

[Link back to DTU Orbit](#)

*Citation (APA):*

Reisinger, S., Kasperl, S., Franz, M., Hiller, J., & Schmid, U. (2011). Simulation-Based Planning of Optimal Conditions for Industrial Computed Tomography. In *International Symposium on Digital Industrial Radiology and Computed Tomography* (Vol. MO.3.1) <http://www.dir2011.com/>

---

### General rights

Copyright and moral rights for the publications made accessible in the public portal are retained by the authors and/or other copyright owners and it is a condition of accessing publications that users recognise and abide by the legal requirements associated with these rights.

- Users may download and print one copy of any publication from the public portal for the purpose of private study or research.
- You may not further distribute the material or use it for any profit-making activity or commercial gain
- You may freely distribute the URL identifying the publication in the public portal

If you believe that this document breaches copyright please contact us providing details, and we will remove access to the work immediately and investigate your claim.

# Simulation-Based Planning of Optimal Conditions for Industrial Computed Tomography

S. REISINGER<sup>\*</sup>, S. KASPERL<sup>\*</sup>, M. FRANZ<sup>\*</sup>, J. HILLER<sup>\*\*</sup>, U. SCHMID<sup>\*\*\*</sup>

<sup>\*</sup>Fraunhofer Development Center for X-ray Technology (EZRT)

(Dr.-Mack-Str. 81, 90762 Fürth, Germany)

<sup>\*\*</sup>Technical University of Denmark

<sup>\*\*\*</sup>Otto-Friedrich University of Bamberg, Germany

**Abstract.** We present a method to optimise conditions for industrial computed tomography (CT). This optimisation is based on a deterministic simulation. Our algorithm finds task-specific CT equipment settings to achieve optimal exposure parameters by means of an STL-model of the specimen and a raytracing method. These parameters are positioning and orientation of the specimen, X-ray tube voltage and prefilter thickness.

## 1. Introduction

The accuracy of manufacturing technology is getting more and more important in modern industry. To control production processes exact measurements of quality and reliability of parts to be produced are essential. For this purpose optical and tactile measurement systems can be used. Only parts of the specimen which are accessible from the outside can be measured non-destructively. A method to resolve this problem is the computed tomography (CT). This imaging technique is able to display the entire specimen being tested including inner structures. Hence inner geometries can be examined and measured.

The limitations of CT are essentially given by the maximum size of specimen and the maximum X-ray path length. The maximum size of the specimen is dependent on the traverse path of the three components of a CT system: X-ray tube, turntable and detector. The maximum X-ray path length is dependent on tube parameters like maximum voltage, current and prefilter. Compared to CT in the medical sector the industrial CT covers a wide range of different specimen. These specimen differ in size from some millimetres to many metres and in material from homogeneous metals to inhomogeneous composite materials like plastic connectors. Hence new parameters must be determined for each task. Until now finding optimal parameters for a CT measurement is bound to personal knowledge. To enable unskilled users to achieve good image quality various approaches were introduced.

Another method to define optimal conditions for X-ray imaging is given by mathematical models [1]. However it is not easy to map a complex system like CT into some simple formulas. According to [2] it is necessary to adapt the exposure time of each projection to the X-ray path length  $x$  to achieve a constant signal-to-noise ratio (SNR). Hereby additional expenses appear by a necessary bright image for each projection. [3] determines the optimal geometric magnification considering the effects of X-ray source distribution, imaging task, X-ray scatter, and image detective quantum efficiency (DQE).

Our approach is to estimate the parameters by a simulation which maps the whole CT imaging process. This deterministic simulation is based on the raytracing approach.

The remainder of this paper is organised as follows: The principles of cone beam computed tomography are presented in section 2. Section 3 describes the idea of the deterministic CT simulation. In section 4 we introduce our method to find optimal CT parameters. Results of this implementation are discussed in section 5. Finally section 6 gives a conclusion and future prospects to this subject.

## 2. Cone beam computed tomography

The CT uses the ability of specimens to attenuate the X-ray beams dependent on their density and thickness. In cone beam CT the specimen is rotated in the radiation field of an X-ray source. A flat panel detector is used to measure the intensity distribution of the radiation after passing the specimen. This process is done for a large number (typically between 800 and 1600) of directions (typically within  $360^\circ$ ). With the data of these projections a 3D reconstruction can be performed.

In comparison to medical applications the industrial CT has some major differences. In the medical sector the specimen (a human) has a relatively uniform size (1.5 - 2.0 m) and composition ( $\approx 63\%$  water, bones, soft tissue and few heavy elements). The industrial CT covers a wide range of variable components. These components differ in size and material composition from small plastic connectors used in the electronic industry to large and heavy metal engine blocks or rotor blades.

Compared to medical CT where X-ray tube and detector rotate around the object (human) in the industrial domain X-ray tube and detector are fixed while the specimen is rotating within the cone beam. Figure 1 shows the setup of a cone beam CT typically used in the industrial sector.

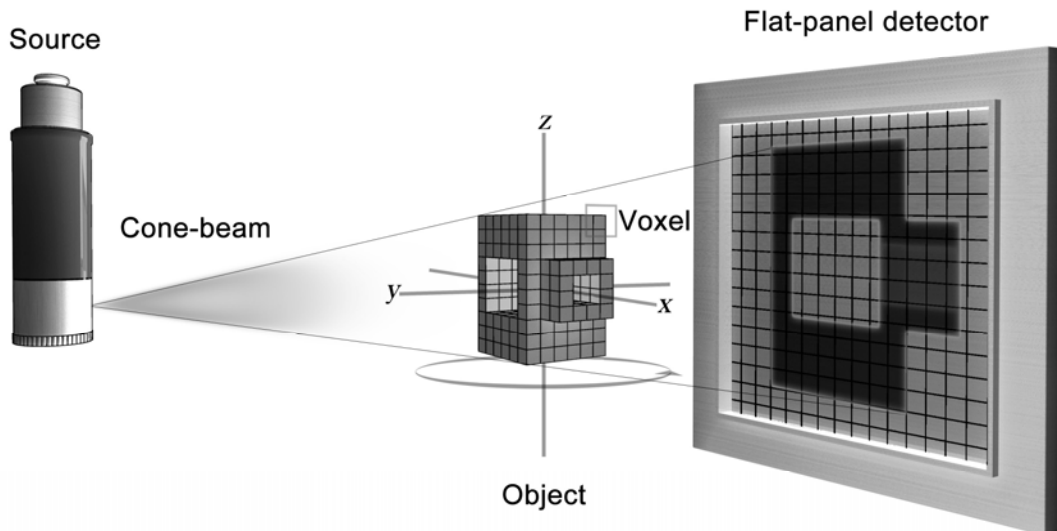
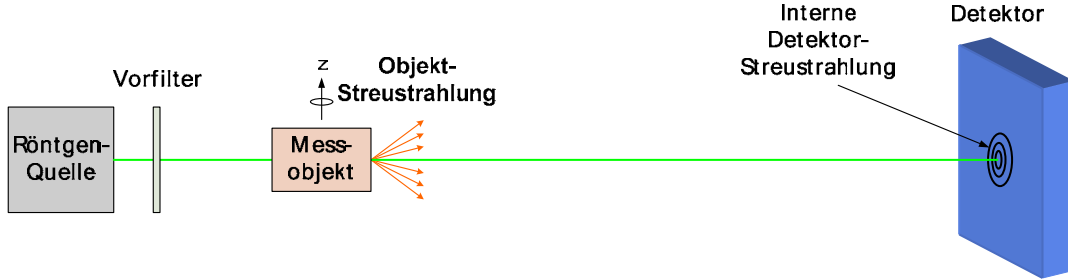

**Figure 1.** Principle of a cone beam CT system.

Typical application areas of industrial CT are locating defects (like air inclusions) within component parts, visualisation and measuring of internal structures and the determination of material characteristics.

### 3. Deterministic CT simulation

To map the whole CT imaging process a deterministic simulation can be used. Therefore Fraunhofer EZRT developed the analytical simulation software Scorpius XLab<sup>®</sup> [4].



**Figure 2.** Principle of the deterministic CT simulation.

The simulation is based on the raytracing approach (Figure 2). The pixel value for each detector pixel  $\bar{P}$  of a virtual detector is given by

$$\bar{P} = \sum_i \bar{N}(E_i) \cdot \bar{QE}(E_i) \cdot \Delta E, \quad \text{with} \quad (1)$$

$$\bar{N}(E_i) = \bar{N}_0(E_i) \cdot e^{-\sum_{n=1}^k \mu_n(E_i) \cdot x_n}, \quad (2)$$

where  $\bar{QE}(E_i)$  is the energy dependent quantum detection efficiency of a simulated detector type [5],  $\Delta E$  is the sampling interval of the X-ray spectra,  $\bar{N}_0$  is the source spectra,  $k$  is the number of objects with a specific material and  $\mu, x$  is the way of a photon inside the specimen and  $\mu$  is the (energy- and material-dependent) linear attenuation coefficient.

### 4. Principle of the Method

Our method is planning the optimal conditions for industrial computed tomography based on the CT simulation introduced in section 3. As input parameters the user passes the ranges of the parameters. This means minimum and maximum tube voltage, minimum and maximum translation position of tube, turntable and detector. In addition the user sets the available prefilter material(s) and thicknesses and an STL (Surface Tessellation Language)-model of the specimen. The next step is to find optimal conditions for the given setup.

#### 4.1 Positioning of the specimen

This part of the calculation sets the specimen to an optimal position between tube and detector and estimates an optimal amplification respectively

$$m = \frac{FDD}{FOD}, \quad (3)$$

where  $FDD$  is the distance between tube (focus) and detector and  $FOD$  is the distance between tube and specimen (object). An optimal setup is illustrated in Figure 3. The best amplification is received for a translation between tube and detector. This is achieved by two conditions. First the full area of the detector should be used and second for each projection position the whole specimen must be projected onto the detector with an

additional space between projection and the border of the detector to receive  $I_0$ -pixels. This means pixels which get the intensity for an X-ray path length of  $x = 0$ .

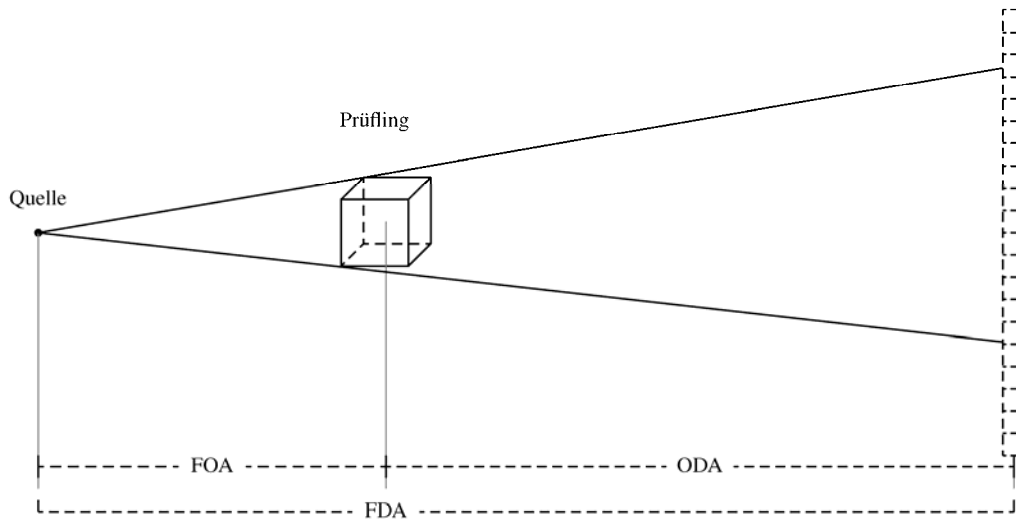

**Figure 3.** Illustration of the optimal amplification.

#### 4.2 Orientation of the specimen

The maximum size of specimen and the maximum X-ray path length determine the limitations of CT. According to the Beer-Lambert law (4) the attenuation of photons traversing material increases exponentially with the length of the object.

$$I = I_0 \cdot e^{-\mu \cdot x}, \quad (4)$$

where  $I$  is the resulting intensity after traversing the  $x$  which is proportional to the pixel value  $\bar{P}$  described in equation (1).

Hence the most important step of optimisation is to find an orientation to minimise the X-ray path length  $x$ . For each projection of a whole CT measurement the X-ray path length should be limited. Excessive attenuation of the X-ray intensity effected by a long X-ray path length cause artefacts within projections. Therefore three approaches were implemented. All of them are based on the generation and evaluation of length images. This means an image containing information of the X-ray path length  $x$  within the specimen on the path of a virtual photon on its way from source to detector. The aim is to find the orientation where the maximum  $x$  is minimised for all projections (typically 800 - 1600) of a whole CT scan.

##### 4.2.1 Orientation by bounding box

An approach to minimise the X-ray path lengths is to set the specimen orientation with the maximum length along the rotation axis. An unsophisticated way to find this orientation is given by a bounding box. However only the outermost points of the object are included which causes a disadvantage. The internal composition of the specimen isn't taken into account. Moreover, the orientation is limited to the three principal axes, see Figure 4 left.

##### 4.2.2 Orientation by inertia tensor

The inertia tensor is an alternative to include the internal structures of the testee. The inertia tensor of a rigid body provides its moments of inertia. The moment of inertia of a body is dependent on its geometric form, the mass distribution and additionally on the rotation axis. It is evaluated by:

$$J = \sum_i g_i r_i^2 \quad (5)$$

$J$  is the moment of inertia,  $g_i$  the mass of a single mass point and  $r_i$  the distance of mass point to rotation axis. Due to the squared distance  $r_i^2$  mass points far away from the rotation centre have a great impact on the moment of inertia. Based on its inertia the body is tilted in such a way that the axis of the maximum moment of inertia is set along the rotation axis. Compared to the orientation by a bounding box the complete structure is taken into account and inner structures are considered. The disadvantage of this approach is given by mass points which get an increasing weighting with ascending distance  $r$ . Hence points with a great distance  $r$  get overestimated.

#### 4.2.3 Orientation by random sampling

To solve the aforementioned problems all single points of the specimen must be taken into account with the same weighting. A way of resolving this is to evaluate length images directly. Our third approach is to sample the object uniformly to get the best orientation. Therefore we use the algorithm described by [6] to generate uniformly-distributed random unit quaternions, see Figure 4 right.

The disadvantage of this approach is the high computing time compared to 4.2.1 and 4.2.2. Furthermore it is not trivial to predict the number of necessary positions to achieve a satisfying result. Infinite computation time would produce definitely a perfect result.

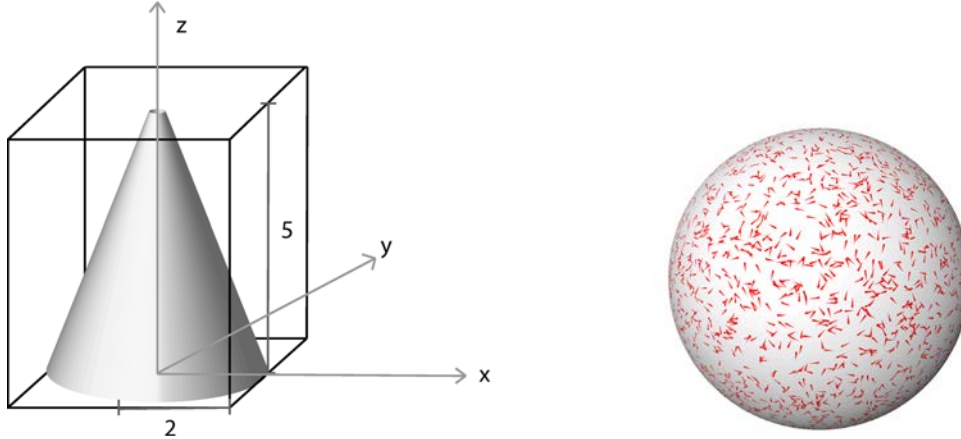

**Figure 4.** Bounding box of a cone (left). Right: visualisation of random sampling.

#### 4.3 X-ray tube voltage

A X-ray projection is influenced by a couple of factors like noise or artefacts. Hence it is important to choose suitable parameters to minimise these factors. Too low intensity causes noisy projections, too high leads to low-contrast projections. The intent of an optimal X-ray tube voltage is to get projections with a minimum intensity above some threshold value.

We divide the source spectrum into some energy ranges to sample it. The intensity of the pixel produced by the maximum X-ray path length is given by

$$I_{\min} = \sum_{i=0} \bar{N}_i \cdot e^{-\mu_i \cdot x_{\max}} \cdot E_i \cdot \overline{QE}(E_i), \quad (6)$$

where  $I_{\min}$  is the intensity for the deposited energy for the detector pixel with the least intensity caused by the maximum X-ray path length  $x_{\max}$ .  $E_i$  is the energy range,  $N_i$  the number of photons of the respective energy range and  $\mu_i$  the resulting absorption

coefficient of current energy and material to be tomographed. Note that the maximum X-ray path length  $x_{\max}$  depends on the orientation calculated in section 4.2.

The resulting contrast-ratio normed to [0, 1] is given by:

$$K = \frac{I_{\min}}{I_0}, \quad (7)$$

$K$  describes the ratio of minimum intensity  $I_{\min}$  and intensity  $I_0$  for a X-ray path length of  $x = 0$ . According to [7] the optimal contrast is given for a ratio  $K = 0,1$ . Figure 5 shows the influence of increasing X-ray tube voltage on contrast  $K$  for an aluminium phantom with various path lengths. Consequential it is obvious that an increasing tube voltage leads to ascending contrast  $K$ . For an energy range between 20 keV and 200 keV the contrast  $K$  is plotted. In this example at about 140 kV we have  $K = 0,1$  for 3 cm Al.

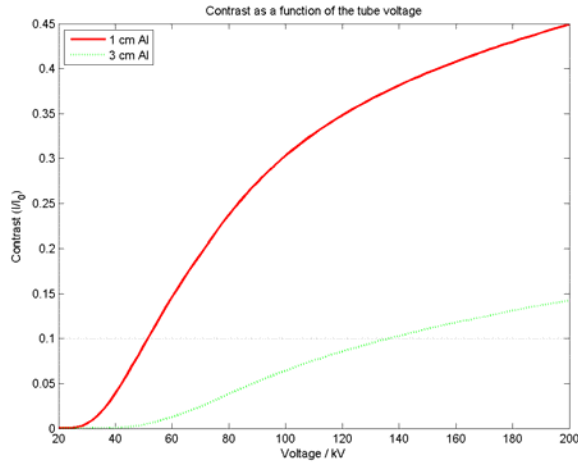

**Figure 5.** Influence of increasing X-ray tube voltage to contrast. The green dashed line points to a X-ray path length  $x = 3$  cm and the red solid line to a length  $x = 1$  cm through an aluminium phantom.

### 4.3 Prefilter

If the maximum available tube voltage is not sufficient to achieve a certain contrast-ratio a prefilter should be used. The resulting intensity caused by the the maximum X-ray path length and the deployed prefilter is therefore given by

$$I_{\min} = \sum_{i=0} \bar{N}_i \cdot e^{-\mu_{i,S} \cdot x_S} \cdot e^{-\mu_{i,P} \cdot x_P} \cdot E_i \cdot \overline{QE}(E_i), \quad (8)$$

where  $\mu_{i,S}$  describes the absorption coefficient of the specimen,  $x_S$  the maximum X-ray path length,  $\mu_{i,P}$  the absorption coefficient of the prefilter and  $x_P$  the prefilter thickness.

Figure 6 shows the influence of increasing prefilter thickness on contrast. The figure illustrates, that a increasing copper-prefilter thickness leads to ascending value of  $K$ . Here a 80 kV spectrum with a varying prefilter thickness (0 – 10 mm) is simulated. About 1 mm copper-prefilter is necessary to reach a  $K = 0,1$  for 3 cm Al.

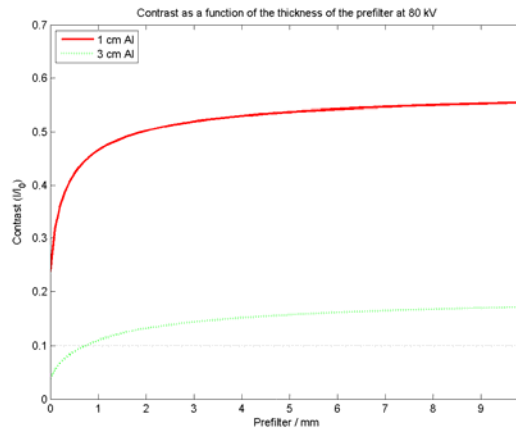

**Figure 6.** Influence of increasing prefilter thickness to contrast.

## 5. Results

Based on the fact that the intensity of photons traversing material decreases exponential with the length through to object by the Beer-Lambert law (4) the orientation has a significant impact on the question whether a specimen can be tomographed or not. Hence the main attention of our algorithm is to calculate the best orientation. As discussed in section 4 the three approaches implemented to achieve the best orientation have various disadvantages. Only the method described in section 4.2.3 achieves definitely a perfect result. The disadvantage of this approach is the long runtime compared to the other methods caused by a great number of length images of various orientations. Moreover it is not trivial to predict the number of orientations to achieve a satisfying result. This number of necessary orientations could be generated using the moment of inertia in section 4.2.2. The herewith calculated central principals axis of inertia leads to an advice on the complexity of a body. The more equal these prinicipals the less positions are necessary to generate a satisfying result.

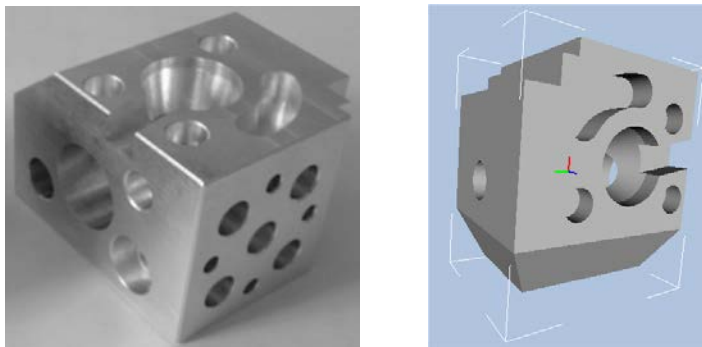
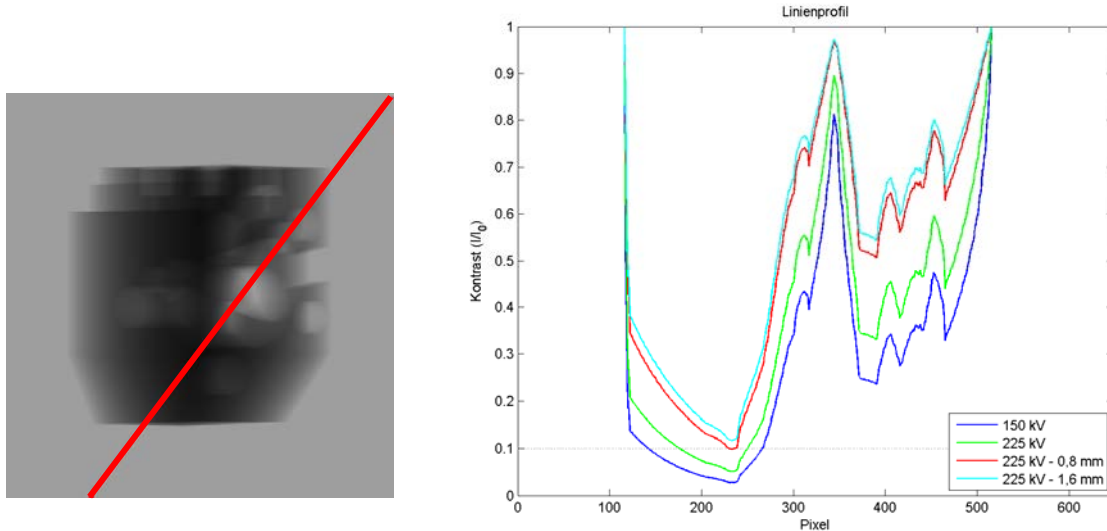

**Figure 7.** Aluminium-Cube. Size: 46 x 39 x 31 mm<sup>3</sup>. Right after optimization of the orientation.

To test the implementation of our idea to optimise conditions for industrial CT we set up experiments with a real CT system. Therefore we calculated an optimal setup with our algorithm and used these data for a real CT measurement. As specimen we used a cube made up of aluminium (Figure 7). This sample offers geometries which appear typically in the application area of industrial computed tomography. For the maxima tube voltage a limit of 225 kV was given. We simulated a CT with varying parameter setups to show the influence of tube voltage and prefilter on projections. Our algorithm calculates an optimal setup of 225 kV tube voltage and 0,8 mm copper prefilter. The best orientation on the rotary plate (using the approach in section 4.2.3) is shown in Figure 7.



Additionally to this setup we simulated projections with less tube voltage (150 kV), an optimal tube voltage with a missing prefilter and a projection with excessive prefilter thickness, see Figure 8. The simulated parameter predictions could be confirmed by a real CT of the aluminium cube. But some more investigations should be done for the fixed value  $K \approx 0.1$  in the standard [7] for the different measuring tasks.



**Figure 8.** Intensity profiles for varying tube voltages/prefilters extracted along the red line in the projection image left.  $K \approx 0.1$  is reached at 225 kV and 0,8 mm copper prefilter.

## 6. Conclusions and outlook

In this paper a new method to optimise conditions for industrial computed tomography (CT) is described. This optimization is based on an analytical simulation model. You could download a free trial version of Scorpius XLab<sup>®</sup> at

<http://www.iis.fraunhofer.de/bf/xrt/ctundmess/xlab/>

The main benefits of our implementation are given by the short computing time which ranges from some seconds to a few minutes. Furthermore no CT system is needed. Finding optimal parameters for a CT measurement by an unskilled user could require up to some hours on a CT system thus generating high costs.

Future work regarding the approach introduced are the optimization of additional parameters like tube current, exposure time or the number of angle steps.

## References

- [1] M. Mangard, P. Hammersberg, Optimal conditions for x-ray imaging by mathematical simulation, Review of Progress in Quantitative Nondestructive Evaluation 2000, 665-672.
- [2] A. F. J. Hofmann, A wall-thickness-based method of adaptive integration time determination for x-ray computed tomography, NDT& E International 39 (2006) 668-674
- [3] J. H. Siewerdsen, D. A. Jaffray, Optimization of x-ray imaging geometry with specific application to flat-panel cone-beam computed tomography, Medical Physics 27 (8) (2000) 1903-1914.
- [4] Wenig P., Kasperl S., Examination of the Measurement Uncertainty on Dimensional Measurements by X-ray Computed Tomography, In Proc: 9th ECNDT, Berlin, Germany, 2006
- [5] M. J. Yaffe, J. A. Rowlands, X-ray detectors for digital radiography, Phys. Med. Biol. 42.
- [6] J. J. Kuffner, Effective sampling and distance metrics for 3d rigid body path planning, Proceedings of the 2004 IEEE, International Conference on Robotics & Automation.
- [7] DIN, Deutsches Institut für Normierung e.v., Zerstörungsfreie Prüfung- durchstrahlungsverfahren - Computertomographie (Entwurf), DIN EN 16016-1, DIN EN 16016-2, DIN EN 16016-3, DIN EN 16016-4.