



Channel Measurements for a Optical Fiber-Wireless Transmission System in the 75-110 GHz Band

Pang, Xiaodan; Yu, Xianbin; Zhao, Ying; Deng, Lei; Zibar, Darko; Tafur Monroy, Idelfonso

Published in:

2011 Asia-Pacific, MWP/APMP Microwave Photonics, 2011 International Topical Meeting on & Microwave Photonics Conference

Link to article, DOI:

[10.1109/MWP.2011.6088659](https://doi.org/10.1109/MWP.2011.6088659)

Publication date:

2011

[Link back to DTU Orbit](#)

Citation (APA):

Pang, X., Yu, X., Zhao, Y., Deng, L., Zibar, D., & Tafur Monroy, I. (2011). Channel Measurements for a Optical Fiber-Wireless Transmission System in the 75-110 GHz Band. In *2011 Asia-Pacific, MWP/APMP Microwave Photonics, 2011 International Topical Meeting on & Microwave Photonics Conference* (pp. 21-24). IEEE. <https://doi.org/10.1109/MWP.2011.6088659>

General rights

Copyright and moral rights for the publications made accessible in the public portal are retained by the authors and/or other copyright owners and it is a condition of accessing publications that users recognise and abide by the legal requirements associated with these rights.

- Users may download and print one copy of any publication from the public portal for the purpose of private study or research.
- You may not further distribute the material or use it for any profit-making activity or commercial gain
- You may freely distribute the URL identifying the publication in the public portal

If you believe that this document breaches copyright please contact us providing details, and we will remove access to the work immediately and investigate your claim.

Channel Measurements for a Optical Fiber-Wireless Transmission System in the 75-110 GHz Band

Xiaodan Pang¹, Xianbin Yu¹, Ying Zhao^{1,2}, Lei Deng^{1,3}, Darko Zibar¹ and Idelfonso Tafur Monroy¹

¹Department of Photonics Engineering, Technical University of Denmark, Kgs. Lyngby, DK 2800, Denmark

²Department of Electronic Engineering, Tsinghua University, Beijing 100084, China

³Wuhan National Laboratory for Optoelectronics, College of Optoelectronics Science and Engineering, HuaZhong University of Science and Technology, Wuhan 430074, China

E-mail: xipa@fotonik.dtu.dk

Abstract— We report on measured optical fiber W-band wireless channel characteristics such as frequency response, channel loss and fading, directivity, channel capacity and phase noise. Our proposed system performs a sextuple frequency up-conversion after 20 km of fiber transmission, followed by a W-band wireless link. Our experimental measurements are intended to provide engineering rules for designing hybrid multi-gigabit W band transmission links.

Keywords— millimeter wave communication, radio-over-fiber, microwave photonics, fiber-optic communication

I. INTRODUCTION

The demand of high capacity wireless communication links is exponentially increasing due to its cost-effectiveness, quick setup and easy upgradable nature, and its suitability for convergence with photonic transmission technology. [1]. In order to realize the seamless convergence of wireless and fiber-optic networks, the capacity of wireless transmission needs to be increased to keep the pace with high-speed fiber-optic communication systems. Therefore, millimeter wave (mm-wave) technology is of great interest as one of the promising approaches to satisfy the high capacity requirement for the future wireless access networks. By definition, the mm-wave covers the frequency range from 30 GHz up to 300 GHz. However, the frequency bands less than 100 GHz have already been allocated for various applications, resulting in limited unlicensed bandwidth left for wireless transmission [2]. The applications and use of the 60 GHz band have been so far well studied and reported in the many literatures, e.g. [3]-[5]. Nevertheless, the under-exploited higher frequency range from 100 GHz to 300 GHz is becoming a timely relevant research topic due to its capability to offer an even wider bandwidth for even faster gigabit-class wireless access rate. Recently, many efforts have contributed to achieving data transmission in the 100 GHz wireless systems, including mm-wave generation and modulation using different techniques, transmission performance tests and analysis [6]-[8]. Most of these work, although they provide details of their experimental configurations, there is less or limited reported details and studies on the wireless channel characteristics, with less studies considering the composite optical fiber-wireless

channel. In particular, due to the atmosphere absorption and the free space fading effect of mm-wave carrier, the mm-wave wireless transmission distance is highly limited. In this context, the well-known radio-over-fiber (RoF) technology, which combines optical and wireless techniques, provides a good solution to increase the coverage while maintaining the mobility of the broadband services in the local area networking scenarios.

In this paper, we experimentally demonstrate a RoF system with a 75-100 GHz (W-band) wireless transmission link. K-band RF signal, generated and modulated with data signal, and then up-converted to W-band by a 6-time frequency multiplier. Using this method, we do not need W-band amplifiers at the transmitter and receiver as we target short range high capacity wireless link with potential reduced complexity. The characteristics of the wireless link are tested and analyzed in terms of frequency response, phase noise, emission distance, directivity, etc. These characteristics are used as basic-considerations for the optimum design of our W-band wireless link. Furthermore, up to 500 Mbps amplitude shift keying (ASK) data traffic transmission over 20 km optical fiber and 50 cm W-band wireless link is used for our experimental demonstrations and analysis.

II. EXPERIMENT SETUPS

Fig. 1 shows the schematic diagram of our experimental setup of a radio-over-fiber system including an additional W-band wireless link. At the transmitter, by using a pulse pattern generator (PPG) and a vector signal generator (VSG), a 12.5-18.4 GHz (K-band) RF signal carrying a pseudo random bit sequence (PRBS) with a word length of 2^7-1 is generated. This signal is then modulated onto a 1550 nm lightwave at a Mach-Zehnder modulator (MZM), which is biased at the linear quadrature point. After 20km non-zero dispersion shifted fiber (NZDSF) and an Erbium-doped fiber amplifier (EDFA), the RF signal is recovered by a photodiode (PD). After a K-band power amplifier, a sextuple millimeter source (Agilent E8257DS15) is used to up-convert the K-band signal into the W-band. A wireless link is established between a pair of waveguide horn antennas with the gain of approximately

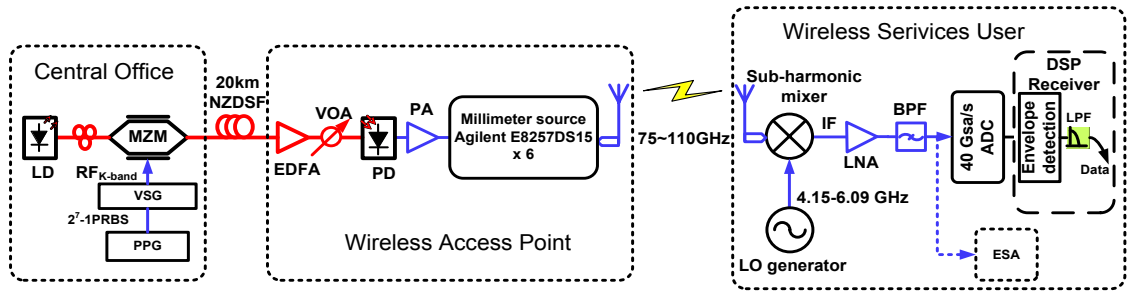

Fig. 1. Experimental setup for a radio-over-fiber system plus a W-band wireless link (LD: laser diode, VOA: variable optical attenuator, PA: power amplifier, LNA: low noise amplifier)

24 dBi. The receiving antenna is directly connected to a sub-harmonic mixer for frequency down-conversion. The local oscillator (LO) signal is 18 times multiplied in the sub-harmonic mixer and then mixed with the received W-band signal. In this way, the received W-band signals are down-converted to the intermediate frequency (IF) at the output of the sub-harmonic mixer. A linear low noise amplifier (LNA) is placed after the mixer to amplify the IF signal. Furthermore, a narrow band pass filter (BPF) is used to filter out-band noise. The IF signal is sampled by a 40 GSa/s analog digital converter (ADC), and then demodulated by a digital signal processing (DSP) based receiver using envelop detection scheme.

In order to characterize the W-band wireless channel, two subsystems are built as shown in Fig. 2. The characteristics measurements of the 100 GHz wireless analogue channel are performed in Fig. 2 (a). The K-band RF signal is directly up-converted into W-band by using the millimeter wave source. After transmitting over the wireless channel, the signal is again down-converted to IF. Subsequently, the characteristics of the IF signal such as signal power, spectrum, and phase noise are analyzed by using an electronic spectrum analyzer (ESA). In that case, we focus on testing the wireless channel in terms of wireless transmission loss, antennas directivity, and the RF carrier frequency, thus data traffic and fiber transmissions are not introduced in our sub-setup system. After that, the wireless transmission performance is tested based on the second subsystem, as shown in Fig. 2 (b). The link transmission

performance under different data rates (1 Gbps, 800 Mbps, 500 Mbps and 312.5 Mbps) and wireless distances is analyzed.

III. EXPERIMENT RESULTS

A. Wireless channel properties

Fig. 3 shows the W-band channel response by measuring the received IF power as a function of signal frequency in terms of different wireless distances. We can see that in general, the received power decreases with the increase of RF frequency in a given distance. It also shows that when the two horn antennas are placed close to each other and the wireless distance is assumed to be zero, the received power is significantly decreased in certain RF frequencies. This phenomenon is caused by the multipath destructive interference effect occurring inside the two antennas' horns.

The 100 GHz wireless channel loss as a function of distance is measured and shown in Fig. 4. In this measurement, the RF frequency from the signal synthesizer is 16.6 GHz, which corresponds to 99.6 GHz W-band frequency after sextuple up-conversion. The RF frequency from the signal synthesizer is 16.6 GHz, which corresponds to 99.6 GHz W-band frequency after sextuple up-conversion. Moreover, the LO frequency at the receiver is 5.48GHz, and then 18 times up converted to 98.64 GHz in the sub-harmonic mixer, which results in an IF frequency of 960MHz. In the experiment, the power of 16.6 GHz RF signal and the LO are set to 0dBm and +13dBm, respectively. Moreover, the LO frequency at the receiver is 5.48 GHz, and then 18 times up converted to 98.64 GHz in the sub-harmonic mixer, which results in an IF frequency of 960 MHz. The power of 16.6 GHz RF signal and the LO are set to 0 dBm and +13 dBm, respectively. Because of the complexity of directly measuring the W-band signal power, the IF power at the receiver is measured based signal power, the IF power at the receiver is measured based on the linear performance of the LNA. We set the received power at 0 cm wireless distance as the reference level. It can be seen that there is around 17 dB loss when the wireless distance is 1 m. When the distance goes up to 4 m, around 33 dB channel loss is observed. It should be noted that during this test we optimally align two antennas to obtain the maximum received

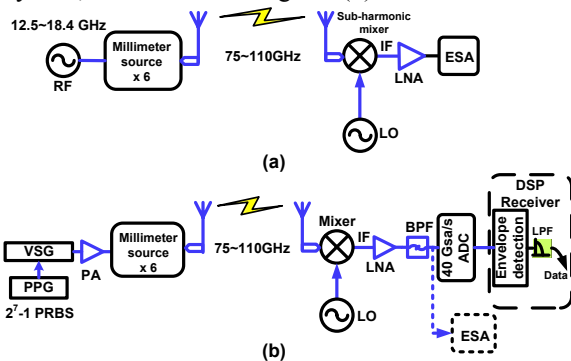

Fig. 2. Schematics of subsystems: (a). W-band analogue channel characteristics test; (b). wireless link transmission test

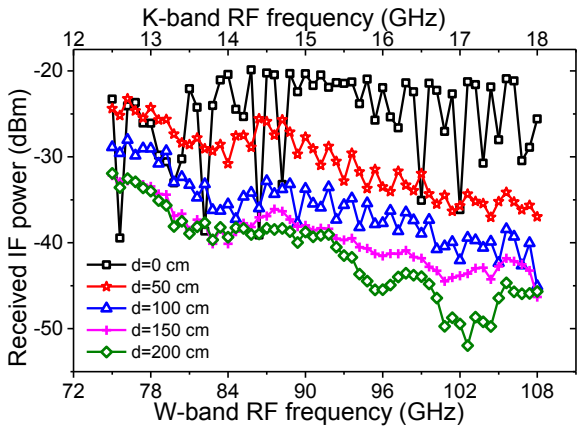

Fig. 3. The W-band channel frequency response in terms of different wireless distances.

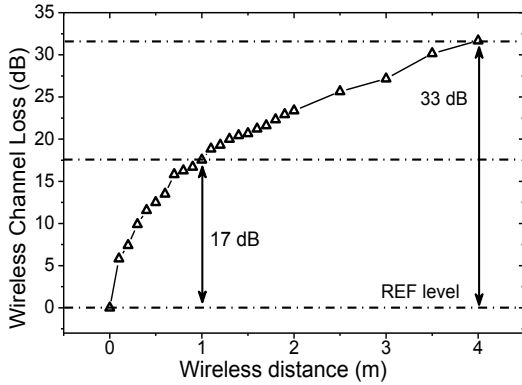

Fig. 4. Received signal power versus wireless distance ($RF_{W\text{-band}} = 99.6\text{GHz}$)

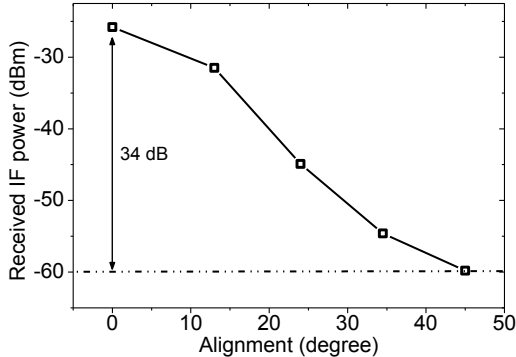

Fig. 5. Received signal power versus alignment between sending and receiving antennas (Source power = 0dBm, $RF_{W\text{-band}} = 99.6\text{GHz}$)

power at every measured distance, and the received power becomes more sensitive to the antenna directivity as the distance increasing.

Fig. 5 shows the impact of the directivity between the transmitting and receiving antennas on the received power. In this measurement the distance between the two antennas is fixed at 40 cm and only the alignment angle between the axes of two antenna's horns is changed. It is observed that the ultimate performance of the wireless link is extremely related to the optimum of alignment. From the figure it can be seen

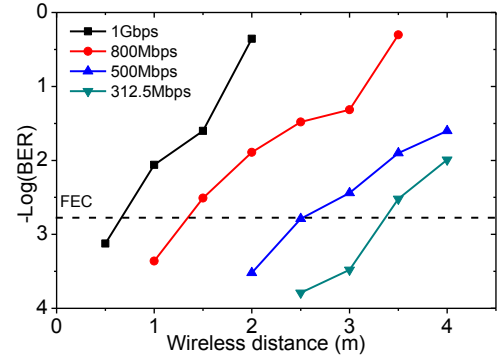

Fig. 6. Measured bit error rate performance against the wireless distance without optical links

that when the alignment angle is increased from 0° to 45° , the power penalty in received signal is around 34 dB.

The transmission performance of the wireless channel is evaluated based on the subsystem in Fig. 2(b). According to the Fig. 3, the mixer has the best frequency response when the input RF frequency is 14.6 GHz, which corresponds to the W-band frequency of 87.6 GHz. Moreover, the LO frequency is set to 4.813 GHz, which results in an output IF of 960 MHz (for 1 Gbps transmission, LO frequency is set to 4.803 GHz, the corresponding IF is 1140 MHz). However, the transmitted data rate is therefore limited by the narrow bandwidth of the receiver mixer. Fig. 6 shows the measured bit error rate (BER) performance under different data rates and the wireless distances between the antennas. We began our measurement from 50 cm distance, at which error free demodulations were achieved at data rates of 800 Mbps and lower, while 1 Gbps transmission had a BER of 7.5×10^{-4} . Assuming the forward error correction (FEC) limit of 2×10^{-3} , transmissions at all the measured bit rates are well below this limit. In the experiment, $\sim 10^5$ sampled bits were used to analyze the BER performance offline. Meanwhile, we can notice that as the distance and bit rate increase, the BER performance goes worse.

B. Transmission performance of the RoF system

After characterizing the wireless channel properties and the data transmission performance of the W-band wireless link, a RoF experimental system is conducted. The wireless distance is fixed at 50 cm and the alignment of antenna's horns is also optimized during our measurement. The 20km NZDSF with 4.6dB insertion loss is used to minimize the impact of fiber dispersion on the up-converted mm-wave signals. The output signal from the VSG is of 14.6GHz and 0 dBm power. To estimate the transmission performance, we firstly measure the phase noise of both the 14.6 GHz source signal and the up-converted 87.6 GHz signal using a W-band ESA, which is calibrated by taking into account the specifications of the down-conversion mixer. The received 87.6 GHz spectrum and the phase noise measurements are shown in Fig. 7. It shows that there is approximately 25 dBc Hz^{-1} difference between the received signal and the source from 100 Hz to 100 kHz, which is due to the frequency nonlinear up-/down-conversions, fiber transmission and phase noise of the LO signal. The phase

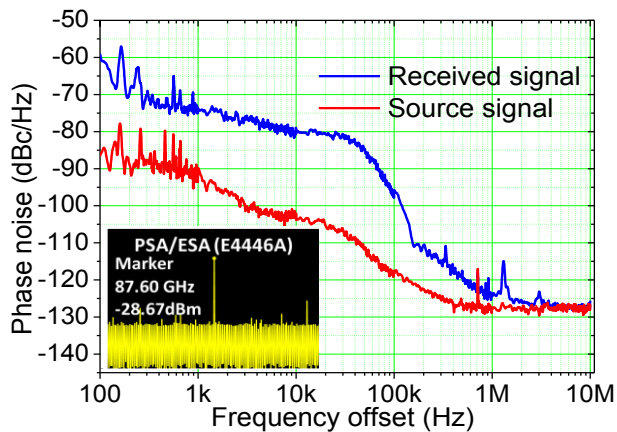

Fig.7. Measured upper sideband phase noise of the 14.6 GHz source and up-converted 87.6 GHz signals

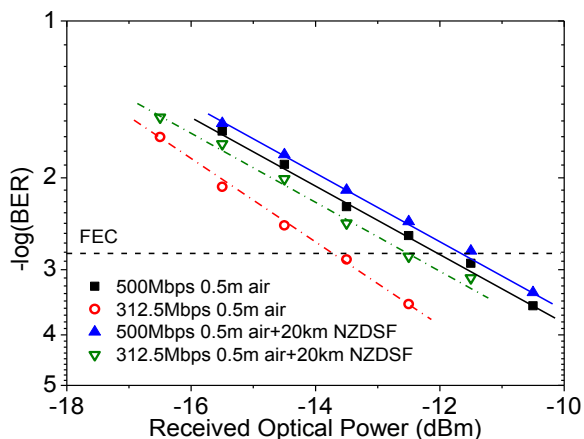

Fig.8. Measured bit error rate for 500 Mbps and 312.5 Mbps in both with and without 20 km fiber link transmissions

noise level of the received signal is below $-60 \text{ dBc}\cdot\text{Hz}^{-1}$ between 100 Hz and 1 kHz and well below $-70 \text{ dBc}\cdot\text{Hz}^{-1}$ above 1 kHz. This phase noise floor is considerably well for data transmission [9]-[10].

The hybrid optical fiber wireless system transmission is demonstrated using the same input K-band RF signal (14.6 GHz, corresponding to 87.6 GHz wireless signal) with the previous transmission test in the subsystem Fig. 2.(b). In the experiment, the wireless distance is set to be fixed at 50cm. The BER performance as a function of the received optical power for 500 Mbps and 312.5 Mbps data rates in both with and without 20 km fiber transmission (B2B) are shown in Fig. 8. Again, considering the FEC limit of 2×10^{-3} , for both B2B and fiber transmission at both tested data rates, the BER performances are all well below this limit. Furthermore, it can be observed that there is approximately 1 dB receiver power penalty between optical back-to-back and 20km NZDSF transmission with 0.5m wireless transmission link at the FEC limit.

IV. CONCLUSION

In this paper, we present an experimentally measured hybrid optical fiber-wireless transmission system with an additional millimeter wave wireless link operating at 75-100 GHz frequency band. Detailed characteristics of a W-band optical fiber wireless in terms of frequency response, emission distance, and antennas' directivity are tested, in order to estimate the channel performance for data transmission. For wireless transmission without optical fiber, 3.5 m for 312.5 Mbps and less than 1 m for 1 Gbps wireless 100 GHz transmission are successfully demonstrated to achieve BER performance below the FEC limit. Furthermore, by employing RoF technology, 500 Mbps composite transmission performance over 20 km NZDSF plus a W-band wireless channel is also presented. Our results show the importance of characterizing the hybrid optical fiber-wireless channel for 75-110 GHz operation and prove the potential applications of such wireless access systems in broadband short range wireless communications.

REFERENCES

- [1] T. Kleine-Ostmann, T. Nagatsuma, "A Review on Terahertz Communications Research," *J of Infrared, Millimeter, and Terahertz Waves*, Vol. 32, Issue 2, pp. 143-171, 2011
- [2] J. Wells, "Faster than fiber: the future of multi-Gb/s wireless," *IEEE Microwave Magazine*, vol. 10, no.3, pp. 104-112, 2009
- [3] M. Beltrán, J. B. Jensen, X. Yu, R. Llorente, I. T. Monroy, "60 GHz DCM and BPSK Ultra-Wideband Radio-over-Fiber with 5 m Wireless Transmission at 1.44 Gbps", *ECOC 2010, Paper Th.9.B.3*.
- [4] H.S. Chung, S.H. Chang, J.D. Park, M.J. Chu, K. Kim "Transmission of Multiple HD-TV Signals over a Wired/Wireless Line Millimeter-Wave Link with 60 GHz", *J. Lightw. Technol.* vol. 25, no. 11, pp. 3413-3418, 2007
- [5] C. T. Lin, J. Chen, P.T. Shih, W.J. Jiang, S. Chi, "Ultra-High Data-Rate 60 GHz Radio-Over-Fiber Systems Employing Optical Frequency Multiplication and OFDM Formats", *J. Lightw. Technol.* vol. 28, no. 16, pp. 2296-2306, 2010
- [6] C. W. Chow, F. M. Kuo, J. W. Shi, C. H. Yeh, Y. F. Wu, C. H. Wang, Y. T. Li, and C. L. Pan, "100 GHz ultra-wideband (UWB) fiber-to-the-antenna (FTTA) system for in-building and in-home networks," *Opt. Express*, vol.18, pp. 473-478, 2010
- [7] A. Hirata, M. Harada, T. Nagatsuma, "120-GHz wireless link using photonic techniques for generation, modulation, and emission of millimeter-wave signals", *J. Lightw Technol.*, vol. 21, pp. 2145-2153, 2003
- [8] R. Sambaraju, J. Herrera, J. Martí, D. Zibar, A. Caballero, J.B. Jensen, I.T. Monroy, U. Westergren, A. Walber "Up to 40 Gb/s Wireless Signal Generation and Demodulation in 75-110 GHz Band using Photonic Technique", *MWP 2010*, post deadline paper 1
- [9] Rotholz, E. "Phase noise of mixers", *Electronics Letters*, vol. 20, issue 19, pp. 786-787, 1984
- [10] G. Qi, J. Yao, J. Seregelyi, S. Paquet, C. Belisle, X. Zhang, K. Wu, R. Kashyap, "Phase-Noise Analysis of Optically Generated Millimeter-Wave Signals With External Optical Modulation Techniques," *J. Lightw. Technol.* vol. 24, no. 12, pp. 4861-4875, 2006