



Membrane Assisted Enzyme Fractionation

Yuan, Linfeng

Publication date:
2011

[Link back to DTU Orbit](#)

Citation (APA):
Yuan, L. (2011). *Membrane Assisted Enzyme Fractionation*. DTU Chemical Engineering.

General rights

Copyright and moral rights for the publications made accessible in the public portal are retained by the authors and/or other copyright owners and it is a condition of accessing publications that users recognise and abide by the legal requirements associated with these rights.

- Users may download and print one copy of any publication from the public portal for the purpose of private study or research.
- You may not further distribute the material or use it for any profit-making activity or commercial gain
- You may freely distribute the URL identifying the publication in the public portal

If you believe that this document breaches copyright please contact us providing details, and we will remove access to the work immediately and investigate your claim.

Membrane Assisted Enzyme Fractionation

Linfeng Yuan

Ph.D. Thesis

September 2011

DEPARTMENT OF CHEMICAL AND BIOCHEMICAL
ENGINEERING (KT)

TECHNICAL UNIVERSITY OF DENMARK (DTU)

Supervisors:

Gunnar Jonsson and John Woodley (DTU)

Lars Korsholm and Sune Jakobsen (Novozymes A/S)

Acknowledgements

This Ph.D. project was performed in close cooperation between the Department of Chemical and Biochemical Engineering at the Technical University of Denmark and the Recovery Pilot Plant at Novozymes A/S under the supervision of Professor Gunnar Jonsson, Professor John Woodley, Lars Korsholm and Sune Jakobsen.

I acknowledge Novozymes Bioprocess Academy for their financial support. I would also like to acknowledge and thank the following people.

First of all, I wish to express thanks to my main supervisor Gunnar Jonsson, for his competent guidance, invaluable advice and great patience. I appreciate his kindness and helpfulness. I am grateful for having such opportunity to start learning membrane technology from scratch under his supervision. I would also like to thank my co-supervisor John Woodley at DTU for his practical advice and help, for his encouragement and for being a continuous source for discussion. My thanks also go to my two co-supervisors Lars Korsholm and Sune Jakobsen from Novozymes for always being helpful and for their valuable discussion and input into this thesis.

Then I would like to thank people at the Recovery Pilot Plant for their generous helps and for the interesting chats at the coffee machine. I would also like to thank my colleagues in DTU PROCESS and CAPEC for their support, encouragement and friendship.

Thanks go to my parents for their unconditional love and endless support. Thanks for being who you are, far from mainstream. Finally to my wife Yiting, I express my heartfelt thanks and love for her great understanding, patience and love; and for the sacrifices made which have allowed me to pursue this project through to the end.

Abstract

Purification of proteins is an increasingly important process for the biotechnology industry. Separation of the desired high value protein from other proteins produced by the cell is usually attempted using a combination of different chromatographic techniques. These techniques separate mixtures of proteins on the basis of their charge, degree of hydrophobicity, affinity or size. Adequate purity is often not achieved unless several purification steps are combined thereby increasing cost and reducing product yield. Conventional fractionation of proteins using ultrafiltration membranes is limited to the variation in size of the proteins and a reasonable separation factor can be observed only when the size difference is in the order of 10 or more. This is partly caused by concentration polarization and membrane fouling which hinders an effective separation of the proteins. Application of an electric field across the porous membrane has been demonstrated to be an effective way to reduce concentration polarization and membrane fouling. In addition, this technique can also be used to separate the proteins based on difference in charge, which to some extent overcome the limitations of size difference.

In this thesis, separations using crossflow electro-membrane filtration (EMF) of amino acids, bovine serum albumin (BSA) and industrial enzymes from Novozymes were performed. The main objective of this study was to investigate the technological feasibility of EMF in the application of industrial enzyme fractionation, such as removal of a side activity from the main enzyme activity.

As a proof-of-concept, amino acids were used as model solution to test the feasibility of EMF in the application of amphoteric molecule separation. A single amino acid was used to illustrate the effect of an electric field on the transport of a charged amino acid; the mass transport can be enhanced or decreased enormously when an electric field is applied in the same direction with convective transport or opposite to the direction of convective transport. Water splitting caused by limiting current density situation was observed at polarity +UF- (anode at ultrafiltration membrane side) due to the depletion of ions in the permeate compartment. By applying the electric field in UF filtration, it was possible to uncouple the transport between the charged Glutamic acid (Glu) and neutral Leucine (Leu) due to the fact that mass transport of Glu was enormously decreased because of electrophoretic force and that of Leu was not affected. The separation performance can be tuned by choosing different combinations of current density and TMP. The highest selectivity value (Leu separation from Glu) was achieved at nearly 90 in the condition of 60 A/m² current density and

TMP 0.3bar. The effect of electric field was also investigated and verified with EMF filtration of BSA solution. EMF filtration of BSA both with ultrafiltration (UF) membrane and more open microfiltration (MF) membrane was studied and compared with normal UF and MF filtration in terms of flux and transmission. It was found that the flux and BSA transmission can be well manipulated and predicted based on the knowledge of solution pH and the polarity of electric field. However, the membrane-protein and protein-protein interactions caused by electrostatic interactions have to be taken into account and should be considered for optimization purpose.

Finally the separation experiments with a binary mixture of Lipase (LP) and Phospholipase (PLA) were performed. Results have shown that separation of LP (side activity) from PLA (main activity) which is not possible to achieve with normal MF has been successfully performed with EMF filtration using MF membrane. The highest selectivity value (LP separation from PLA) of around 5 was obtained when operating with EMF. The effects of feed concentration, solution pH, property of porous membrane TMP and electric field strength have been investigated in the EMF experiments. It has been found that the separation performance in terms of selectivity and Lipase purity in permeate was dependent on the feed concentration, solution pH and membrane properties. The effects of increasing electric field strength and TMP on the separation performance were very small in the investigated range. The mass transport of each enzyme can be well explained by the Extended-Nernst-Planck equation. Better separation was observed at lower feed concentration, higher solution pH in the investigated range and with a polysulfone (PS) MF membrane. It can be concluded that EMF has been successfully demonstrated for the separation of enzymes which normal pressure-driven membrane process could not achieve. However, in order to achieve better separation a holistic optimization procedure is needed for future work.

Resumé

Oprensning af proteiner er en proces i stadigt stigende vigtiggrad for den bioteknologiske industri. Separering af det ønskede protein af høj værdi fra andre proteiner, produceret at cellen sker oftest ved en kombination af forskellige kromatografiske teknikker. Disse separerer blandinger af proteiner på basis af ladninger, grad af hydrofobicitet eller molekylær størrelse. Tilstrækkelig renhed opnås ofte kun ved kombination af adskillige rensningstrin, hvorfor de samlede omkostninger stiger og produktudbyttet falder. Konventionel fraktionering af proteiner ved brug af ultrafiltreringsmembraner er begrænset til forskelle i størrelse af proteinerne, og en rimelig separationsfaktor kan kun opnås når størrelsesforskellen proteinerne imellem er en faktor 10 eller mere. Dette skyldes til dels polarisation af koncentration og tilsmudsning af membranens overflade, hvilket forhindrer en effektiv separation. Anvendelse af et elektrisk felt henover den porøse membran har vist sig en effektiv måde at reducere koncentrationspolarisationen og membrantilsmudsningen. Derudover kan denne teknik også bruges til at separere proteiner med forskellige ladninger, hvilket til en hvis grad overvinder begrænsningerne i størrelsesforskel.

I denne afhandling er undersøgt separation af aminosyrer, bovine serum albumin (BSA) og industrielle enzymer fra Novozymes ved brug af crossflow electro-membrane filtration (EMF). Hovedformålet med studiet var at undersøge den teknologiske muliggørelse af EMF indenfor industriel enzymfraktionering, såsom fjernelse af sideaktiviteter fra hovedaktivitet.

Som proof-of-concept, blev aminosyrer brugt som modelopløsning til at teste muliggørelse af EMF i forbindelse med amfoterisk molekylseparation. En enkelt aminosyre blev brugt til at illustrere effekten af et elektrisk felt på transporten af en ladet aminosyre. Massetransporten kan forøges eller mindskes kraftigt når en elektrisk felt virker i samme retning som, eller modsatrettet, den konvektive transport. Vanddeling forårsaget ved grænsende strømdensitet blev observeret ved polaritet $+UF^-$ (anode ved membransiden), forårsaget af udtømmningen af ioner i permeatsiden. Ved anvendelse af et elektrisk felt i ultrafiltreringen, var det muligt at afkoble transporten imellem det ladede molekyle Glu og det uladede Leu, grundet en enorm mindskelse i transporten af Glu som følge af elektroforetiske kræfter. Separationen kan indstilles ved valg af forskellige kombinationer af strømdensitet og det trans-membrane tryk (TMP). Den største selektivitet (Leu ift. Glu) blev næsten 90 ved 60 A/m² strømdensitet og 0.3 bar TMP. Effekten af det elektriske felt blev også undersøgt og verificeret ved EMF af BSA-opløsning. EMF af BSA med UF og de mere åbne MF-

membraner blev undersøgt og sammenlignet med konventionel UF og MF i form af flux og gennemtrængning. Det blev fundet, at fluxen og gennemtrængningen kan manipuleres og forudsiges baseret på kendskab til pH og polaritet af det elektriske felt. Membran-protein og protein-protein interaktioner som følge af elektrostatiske kræfter skal dog tages i behold, og bør udnyttes i forbindelse med optimering.

Endelig har separationseksperimenter med binære blandinger af lipase (LP) og phospholipase (PLA) vist, at det er muligt at isolere LP (sideaktivitet) fra PLA (hovedaktivitet) ved brug af EMF med MF-membraner, hvilket ikke er muligt med normal MF. Den største selektivitet (LP ift. PLA) blev observeret til ca. 5. Effekterne af fødekonzentration, pH, membrankarakteristika, TMP og elektrisk feltstyrke er ligeledes undersøgt. Det er vist, at separationen, i form af selektivitet og lipaserenhed, afhænger af fødekonzentration, pH og membrankarakteristika. Elektrisk feltstyrke og TMP bidrager i mindre grad til separationen end de øvrige faktorer. Massetransporten af hvert enzym kan vel karakteriseres ved den udvidede Nernst-Planck-teori. En bedre separation blev observeret ved lavere fødekonzentration, højere pH og med en polysulfon-MF-membran. Det kan konkluderes, at EMF succesfuldt har separeret proteiner, som normale tryk-drevne membraner ikke kan opnå. For at opnå en endnu bedre separation er det nødvendigt at antage en holistisk optimeringsprocedure for fremtidigt arbejde.

Contents

Preface

1	Literature review.....	1
1.1	Enzymes and their production.....	1
1.1.1	Conventional enzyme purification technologies and challenges	7
1.2	Membrane technology in enzyme production and challenges	11
1.3	Pressure-driven membrane technology for protein/enzyme separation	12
1.3.1	General concepts and definitions of crossflow membrane filtration	13
1.3.2	Protein separation by microfiltration	20
1.3.3	Protein separation by ultrafiltration	21
1.3.4	Protein separation by nanofiltration.....	24
1.4	Membrane chromatography and its application to protein separation	24
1.5	Electro-membrane filtration and its application to protein separation.....	28
1.6	Conclusions	33
2	Experimental and theoretical	35
2.1	Materials.....	35
2.2	Analyses	37
2.2.1	Analytical methods	37
2.2.2	Separation performance evaluation.....	38
2.3	Theoretical aspects	39
2.4	Experimental set-up.....	44
3	Electro-ultrafiltration of amino acids.....	47
3.1	Introduction	47
3.2	Materials and methods.....	49
3.2.1	Charge characteristics of amino acid	49
3.2.2	Experimental procedure	51
3.3	Results and discussion.....	52
3.3.1	Operation of system using NaCl	52
3.3.1.1	Effects of polarity and current density on permeate conductivity change.....	53

3.3.1.2	Effect of TMP on permeate conductivity change	54
3.3.2	EMF of single amino acids	55
3.3.2.1	Negatively charged Glu	56
3.3.2.2	Positively charged Lys.....	59
3.3.2.3	Relation between flux and polarity.....	62
3.3.3	EMF separation of amino acids	64
3.3.3.1	EMF and UF in the application of amino acids separation	66
3.3.3.2	Studies of the parameters influencing separation	67
3.3.3.2.1	Permeate conductivity and permeate pH.....	69
3.3.4	Electro-diafiltration.....	70
3.4	Conclusions	71
4	EMF of bovine serum albumin	73
4.1	Introduction	74
4.2	Materials and Methods	74
4.2.1	UF filtration experiments	75
4.2.2	EUF filtration experiments.....	76
4.2.3	MF filtration experiments	76
4.2.4	EMF filtration Experiments	76
4.3	Results and discussion.....	77
4.3.1	Filtration with UF membrane.....	77
4.3.1.1	UF filtration of BSA	77
4.3.1.1.1	Flux and rejection change as function of TMP and time.....	78
4.3.1.2	EUF of BSA.....	80
4.3.1.2.1	Effects of electric field and feed pH on flux and rejection.....	82
4.3.1.3	UF Membrane fouling tendency after each experiment	91
4.3.1.4	Summary.....	92
4.3.2	Filtration with MF membrane	93
4.3.2.1	MF of BSA	93
4.3.2.1.1	Flux and rejection change as function of time and TMP.....	94
4.3.2.1.2	Effect of solution pH on flux and rejection	98
4.3.2.1.3	Effect of MF operation manner on flux and rejection	101
4.3.2.2	EMF of BSA	106

4.3.2.2.1	Effects of electric field and feed pH on flux and rejection.....	107
4.3.2.3	MF Membrane fouling tendency after each experiment.....	115
4.3.2.4	Summary.....	117
4.4	Conclusions	117
5	EMF of industrial enzymes.....	119
5.1	Introduction	119
5.2	Materials and Methods	124
5.3	Results and discussion.....	125
5.3.1	Single enzyme filtration.....	125
5.3.1.1	PLA filtration.....	126
5.3.1.1.1	Effect of TMP on flux and transmission.....	126
5.3.1.1.2	Effect of solution pH on flux and transmission.....	129
5.3.1.1.3	Effect of electric field on transmission and flux.....	131
5.3.1.1.4	Effect of batch variations on flux and transmission during EMF filtration.....	133
5.3.1.1.5	Solubility issue at low pH.....	135
5.3.1.2	LP filtration.....	136
5.3.1.2.1	Effect of TMP on flux and transmission.....	136
5.3.1.2.2	Effect of solution pH on flux and transmission.....	140
5.3.1.2.3	Effect of feed concentration on flux and transmission	142
5.3.2	Summary	143
5.3.3	Separation of PLA and LP	144
5.3.3.1	PS membrane	145
5.3.3.1.1	Separation of PLA and LP by MF filtration	145
5.3.3.1.2	Separation of PLA and LP by EMF.....	148
5.3.3.2	Cellulose based membrane	159
5.3.3.2.1	Hydrosart membrane in MF and EMF filtration.....	159
5.3.4	Summary	176
5.4	Conclusions	177
6	General discussion and future work	179
6.1	Conclusions	179
6.2	Recommendations for future work.....	182
7	Appendixes	187

7.1	Appendix 1	187
7.2	Appendix 2	189
7.3	Appendix 3	191
7.4	Appendix 4	192
7.5	Appendix 5	194
7.6	Appendix 6	195
7.7	Appendix 7	197
7.8	Appendix 8	200

List of Figures

Figure 1.1 General scheme of the downstream processing in biotechnology.....	4
Figure 1.2 Downstream processing scheme applied in the production of bulk industrial enzymes[5]	6
Figure 1.3 Industrial-scale halide salt crystallization of subtilisin [12].....	9
Figure 1.4 Diagrammatic representation of gel chromatography	10
Figure 1.5 General scheme of crossflow membrane filtration.....	14
Figure 1.6 Diagrammatic of batch concentration mode.....	15
Figure 1.7 Diagrammatic of continuous concentration mode.....	16
Figure 1.8 Definitions in crossflow filtration: (A) basic parameters; (B) membrane geometries; (C) characterizing the permeation of soluble components [26]	18
Figure 1.9 Principle of membrane chromatography [79].....	25
Figure 1.10 Comparison of solute transport between column chromatography and membrane chromatography [74].....	26
Figure 1.11 Principle of MF/UF in the presence of electric field [95]	29
Figure 1.12 Principle of the electrophoretic membrane contactor [109]	32
Figure 2.1 Structure of polysulfone unit	37
Figure 2.2 Structure of cellulose unit.....	37
Figure 2.3 The comparison of schematic representation of the solute and ions transport (A)at the beginning and (B) end of EMF [102].....	41
Figure 2.4 Experimental batch-wise EMF set-up in the study [2,118].	45
Figure 3.1 Relative fraction of Glu as function of the solution pH	50
Figure 3.2 Relative fraction of Leu as function of the solution pH	50
Figure 3.3 Relative fraction of Lys as function of the solution pH	51
Figure 3.4 Permeate conductivity changes in the permeate reservoir at different current densities, polarities and at constant TMP 0.6bar during EMF of NaCl.....	54
Figure 3.5 Permeate conductivity changes in the permeate reservoir at different TMP, polarities and at constant current density during EMF of NaCl.....	55
Figure 3.6 (A)Permeate concentration and (B)feed concentration of Glu with and without the application of electric field at different polarity, feed pH at 7 ± 0.5 during EMF of Glu.....	57
Figure 3.7 Conductivity and pH changes in the permeate compartment both at polarity +UF- and -UF+ during EMF of Glu	58
Figure 3.8 Lys concentration changes measured from the permeate and electrolyte compartment with and without the application of electric field at polarity +UF- at constant TMP 0.28 bar, feed pH at 7.2 ± 0.2	60
Figure 3.9 Lys concentration changes measured from permeate, feed and electrolyte compartments with and without the application of electric field at polarity -UF+ at constant TMP 0.28bar, feed pH at 7-9.5	60
Figure 3.10 Conductivity and pH changes in permeate compartment during EMF of Lys.....	61

Figure 3.11 Variations of the resulting voltage in different operation conditions during EMF of Glu and Lys at current density 40A/m^2	62
Figure 3.12 Flux change by applying electric field both at polarity +UF- and -UF+ during EMF of Glu-	63
Figure 3.13 Flux change by applying electric field both at polarity +UF- and -UF+ during EMF of Lys+	64
Figure 3.14 Schematic presentation of main transport phenomena taking place during EMF separation of Glu and Leu	65
Figure 3.15 The permeate concentrations of Glu and Leu obtained without and with electric field applied at polarity +UF-, pH of feed solution stayed at 6.6 ± 0.2	66
Figure 3.16 The concentration change of Leu and Glu in permeate compartment at different combinations of current and TMP at polarity +UF-	68
Figure 3.17 Changes of concentration ratio relative to the original feed concentrations of Leu and Glu during electrodiafiltration at polarity +UF-	70
Figure 4.1 Zeta-potential of BSA as function of solution pH [126]	74
Figure 4.2 Permeation flux and permeate concentration of BSA as function of TMP from Exp. Nr.A during UF of BSA	78
Figure 4.3 Permeate flux and permeate concentration of BSA at TMP 1.37bar from Exp Nr.B during UF of BSA	79
Figure 4.4 Comparison of the permeate flux obtained at different feed pH during UF of BSA	83
Figure 4.5 Comparison of the permeate flux changes obtained at different feed pH during EUF of BSA at polarity +UF-	84
Figure 4.6 Comparison of the rejections obtained at different feed pH during UF of BSA	85
Figure 4.7 Comparison of the rejections obtained at different feed pH during EUF of BSA at polarity +UF-	86
Figure 4.8 Comparison of the permeate flux obtained from different feed pH during UF of BSA	87
Figure 4.9 Comparison of the permeate flux changes obtained from different feed pH during EUF of BSA at polarity -UF+	88
Figure 4.10 Comparison of the rejections obtained at different feed pH during UF of BSA	89
Figure 4.11 Comparison of the rejections obtained from different feed pH during EUF of BSA at polarity -UF+	90
Figure 4.12 Comparison of the UF membrane fouling tendency of each experiment by comparing the water permeability before and after each experiment	91
Figure 4.13 Permeation flux and permeate concentration of BSA as function of TMP during MF of BSA	94
Figure 4.14 Rejection calculated at 3 selected TMP from Exp. Nr.1 during MF of BSA	95
Figure 4.15 Permeate flux and concentration change as function of time at two constant TMPs during MF of BSA	96
Figure 4.16 Comparison of the rejections obtained from two constant TMPs during MF of BSA	97
Figure 4.17 Comparison of the permeate flux obtained at different feed pH during MF filtration of BSA	98
Figure 4.18. Comparison of the solute flux obtained at different feed pHs during MF of BSA	99

Figure 4.19 Comparison of BSA rejections obtained at different feed pHs during MF of BSA.....	100
Figure 4.20 Comparison of the permeate flux and permeate concentration of BSA obtained from different feed pH at two constant TMPs during MF of BSA operated without permeate circulation	102
Figure 4.21 Comparison of rejections obtained at different feed pHs, constant TMP 0.6 bar during MF of BSA operated without permeate circulation	104
Figure 4.22 Comparison of rejections obtained at different feed pHs, constant TMP 1.2 bar during MF of BSA operated without permeate circulation	105
Figure 4.23 Comparison of the measured and calculated permeate BSA concentration obtained at different feed pHs during EMF of BSA at polarity +MF-	107
Figure 4.24 Comparison of the permeate flux obtained at different feed pH during MF and EMF of BSA at polarity+MF- of BSA	109
Figure 4.25 Comparison of BSA rejections obtained at different feed pH during MF and EMF of BSA at polarity+MF-	111
Figure 4.26 Comparison of the measured and calculated permeate BSA concentration obtained at different feed pHs during EMF filtration of BSA at polarity -MF+	112
Figure 4.27 Comparison of the permeate flux obtained at different feed pHs during MF and EMF of BSA at polarity-MF+	113
Figure 4.28 Comparison of BSA rejections obtained at different feed pHs during MF and EMF of BSA at polarity-MF+	114
Figure 4.29 Comparison of MF membrane fouling tendency of each experiment by comparing the water permeability before and after each experiment	116
Figure 5.1 The operation boundary for EMF and normal membrane filtration for enzyme/protein separation	120
Figure 5.2 Two ways of operating the separation dependent on which compartment the target protein transported (A) side activity (S.D) collected in permeate (B) main activity (M.D) collected in permeate	121
Figure 5.3 Average molecular charge of PLA and LP as function of solution pH (calculated by Novozymes internal software)	122
Figure 5.4 Operation pH selection based on the solute flux of LP and PLA as function of pH by EMF	123
Figure 5.5 (A)The transmission of PLA and (B) permeate flux at 25min of each TMP obtained during MF of 15g/L PLA	127
Figure 5.6 (A)Transmission of PLA and (B) permeate flux obtained at different solution pH during 2 hours' MF of 15g/L PLA at constant TMP 0.35bar.....	130
Figure 5.7 (A)Transmission of PLA and (B) permeate flux obtained from MF filtration with and without electric field, initial feed concentration 15g/L, pH 5, TMP at 0.35bar.....	132
Figure 5.8(A)Permeate flux and (B) transmission comparison obtained from two different Batches of PLA during EMF of PLA, experiments were run with the same initial feed concentration 15g/L, feed pH 5, TMP 0.35bar and 1364V/m with polarity -MF+	134

Figure 5.9 (A) Permeate flux and (B) transmission improvement by addition of 5mM Na ₂ SO ₄ , experiments were ran with the same initial feed concentration 15g/L (stock solution from Batch A), feed pH 5, TMP 0.35bar and 1364V/m with polarity –MF+	136
Figure 5.10 (A) Transmissions and (B) permeate flux during the step-up and step-down MF experiments, feed concentration 2g/L LP	137
Figure 5.11 (A) Permeate flux and (B) transmission of PLA obtained during conventional MF filtration of 2g/L LP at pH 7	140
Figure 5.12 (A) Transmission of LP and (B) Permeate flux obtained at two pHs during MF of LP, initial feed concentration 2g/L, TMP at 0.3bar	141
Figure 5.13 Effects of feed concentration on (A) Permeate flux and (B) transmission during MF of LP at TMP 0.3bar, pH 7	143
Figure 5.14 (A) Permeate flux and (B) PLA and LP transmissions obtained from the MF of PLA and LP, initial feed concentration 21.8g/L (PLA+LP) with 23.2% LP, pH 5, TMP 0.35bar	146
Figure 5.15 Selectivity obtained during the MF of PLA and LP, initial feed concentration 21.8g/L (PLA+LP) with 23.2% LP, pH 5, TMP 0.35bar	147
Figure 5.16 Effect of electric field on flux during EMF of PLA and LP (.....	148
Figure 5.17 Effect of electric field on transmission EMF of PLA and LP	149
Figure 5.18 Comparison of the selectivity obtained during MF and EMF of PLA and LP.....	150
Figure 5.19 Effect of feed concentration on flux during EMF of PLA and LP	151
Figure 5.20 Effect of feed concentration on transmission during EMF of PLA and LP	152
Figure 5.21 Effect of feed concentration on solute flux of PLA and LP during EMF operation ...	153
Figure 5.22 Effect of feed concentration on selectivity during EMF of PLA and LP	154
Figure 5.23 Effect of PLA batch variation on permeate flux during EMF of PLA and LP.....	155
Figure 5.24 Effect of PLA batch variation on transmissions during EMF of PLA and LP	156
Figure 5.25 Effect of PLA batch variation on solute flux during EMF of PLA and LP.....	157
Figure 5.26 Effect of PLA batch variation on selectivity during EMF of PLA and LP	158
Figure 5.27 Comparison of the flux obtained during MF of PLA and LP using GRM and Hydrosart membrane	160
Figure 5.28 Comparison of the measured permeate concentration of PLA and LP as function of time during MF of PLA and LP using GRM and Hydrosart membrane.....	160
Figure 5.29 (A) Permeate flux and (B) solute flux of the two enzymes during EMF	162
Figure 5.30 Selectivity obtained during EMF of PLA and LP	163
Figure 5.31 Comparison of the permeate flux obtained at different feed pHs during EMF of PLA and LP	166
Figure 5.32 Comparison of the transmissions of PLA and LP obtained at different feed pHs during EMF of PLA and LP	167
Figure 5.33 Comparison of solute fluxes of PLA and LP obtained at different feed pH s during EMF of PLA and LP	168
Figure 5.34 Comparison of the selectivity obtained from different feed pHs during EMF of PLA and LP	169
Figure 5.35 Comparison of permeate flux obtained at different electric field strength during EMF separation of PLA and LP.....	170

Figure 5.36 Comparison of the transmissions of PLA and LP obtained at different electric field strength during EMF of PLA and LP	171
Figure 5.37 Comparison of the solute fluxes of PLA and LP obtained at different electric field strength during EMF	172
Figure 5.38 Comparison of the selectivity obtained at different electric field strength during EMF of PLA and LP.....	173
Figure 5.39 Comparison of the permeate flux obtained at different TMP during EMF of PLA and LP	174
Figure 5.40 Comparison of the transmissions of PLA and LP obtained at different TMP during EMF of PLA and LP	174
Figure 5.41 Comparison of the solute fluxes of PLA and LP obtained at different TMP during EMF of PLA and LP	175
Figure 5.42 Comparison of the selectivity obtained at different TMP from EMF of PLA and LP .	176
Figure 6.1 Diagrammatic description for the design of binary mixture separation at polarity -MF+	182
Figure 6.2 Demonstration of multicompartement for trinary mixture protein separation	184
Figure 7.1 Variations of current as function of time in the 4 experiments during EUF of BSA at polarity +UF-	187
Figure 7.2 Variations of pH in (A) the permeate compartment and (B) the feed compartment during EUF of BSA when operating at polarity +UF-	188
Figure 7.3 Variations of conductivity in (A) the permeate compartment and (B) the feed compartment during EUF of BSA when operating at polarity +UF-.....	188
Figure 7.4 Variation of current as function of time during EUF of BSA at polarity –UF+	189
Figure 7.5 Variations of pH in (A) the permeate compartment and (B) the feed compartment during EUF of BSA when operating at polarity –UF+	190
Figure 7.6 Variations of conductivity in (A) the permeate compartment and (B) the feed compartment during EUF of BSA when operating at polarity –UF+.....	190
Figure 7.7 Comparison of the measured and calculated permeate BSA concentration during MF of BSA with permeate solution circulating at different feed pHs	191
Figure 7.8 The resulting current in Exp. Nr.4 and Nr.8 during EMF of BSA at polarity + MF- at constant electric field 909V/m	192
Figure 7.9 The resulting current in Exp. Nr.3 and Nr.6 during EMF of BSA at polarity – MF+ at constant electric field 909V/m	193
Figure 7.10 Photo showing PLA precipitation happened when pH titrated to 5, the precipitation was mitigated when increasing conductivity	195
Figure 7.11 Photo showing different PLA solutions after centrifugation.....	196
Figure 7.12 IEF results of PLA and LP	197
Figure 7.13 SDS results of PLA and LP	198
Figure 7.14 Photos showing qualitative analysis of electrophoretic mobility by gel electrophoresis, gels made at (A) pH 6 and (B) pH 5	199
Figure 7.15 Zeta-potential of the MF membranes as function of pH measured in a 10mM KCl solution, zeta-potential calculated based on (A) the HelmHoltz-Smoluchowski equation and (B) the Fairbrother-Mastin equation	200

List of Tables

Table 1.1 Common parameters and definitions in crossflow membrane filtration.....	18
Table 1.2 Different cases of separation in electrophoretic membrane contator [109].....	32
Table 2.1 Physical-chemical properties of amino acids used in the study.....	35
Table 2.2 Physical-chemical properties of enzyme stock solution used in the study.....	36
Table 3.1 Summary of experimental conditions for EMF of NaCl	53
Table 3.2 Summary of experimental conditions for EMF of single amino acids	56
Table 3.3 Summary of experimental conditions for EMF of binary mixture Glu and Leu	65
Table 3.4 Summary of the selectivity and purity at 60 min of UF and 120 min of EMF (60 min after applying current).....	67
Table 3.5 Summary of the selectivity and purity obtained at 60 min from each experiment during EMF of Glu and Leu	69
Table 4.1 Experimental conditions and of UF filtration of BSA	78
Table 4.2 Experimental conditions of EUF of BSA	80
Table 4.3 Expectation of the rejection and permeation flux change during EUF of BSA as compared to normal UF filtration at the same feed pH	81
Table 4.4 Experimental conditions of MF filtration of BSA	94
Table 4.5 Experimental conditions of MF of BSA in normal MF filtration manner (without permeate circulation).....	101
Table 4.6 Experimental conditions of EMF filtration of BSA.....	106
Table 5.1 Summary of experimental conditions and separation improvement in terms of selectivity and LP purity in permeate by applying electric field in MF	150
Table 5.2 Summary of experimental conditions and comparison of separation performance in terms of selectivity and LP purity obtained at different feed concentration during EMF operation.....	154
Table 5.3 Summary of experimental conditions and comparison of separation performance in terms of selectivity and LP purity obtained during EMF of PLA and LP with different PLA batches.....	158
Table 5.4 Summary of the results from the experiments performed with and without addition of CaCl ₂ during EMF of PLA and LP	164
Table 5.5 Summary of experimental conditions during EMF of PLA and LP at different feed pHs	165
Table 5.6 Summary of experimental conditions performed at different electric field strength.....	169
Table 5.7 Summary of experimental conditions performed at different TMP.....	173
Table 7.1 Comparison of PLA physical-chemical properties before and after diafiltration.....	194

List of symbols

Nomenclature

A	Effective membrane surface or electrode area [m^2]
A_{cs}	Cross-sectional area for feed flow in the membrane flow channel [m^2]
C	concentration [g.L^{-1}]
C_f	Feed concentration [g.L^{-1}]
C_r	Retatate concentration [g.L^{-1}]
$C_{f,0}$	Initial feed concentration [g.L^{-1}]
C_p	permeate concentration [g.L^{-1}]
D	Diffusivity coefficient [$\text{m}^2.\text{s}^{-1}$]
d_p	Diameter of membrane pore size [μm]
d_{protein}	Diameter of protein [μm]
E	Electric field strength [V.m^{-1}]
E_f	electric filed strength in feed compartment [V.m^{-1}]
f	Solute purity in permeate [%]
F	Faraday constant ($=96485$) [C.mol^{-1}]
h	Height of the channel [m]
h_f	Height of the feed channel [m]
I	Current [A]
J	Flux [$\text{L.m}^{-2}.\text{h}^{-1}$]
J_w	volume flux of water [$\text{L.m}^{-2}.\text{h}^{-1}$]
K	conductivity [mS.cm^{-1}]
K_f	Feed conductivity [mS.cm^{-1}]
L	length of the filtration channel [m]
m_i	Electrophorectic mobility [$\text{m}^2.\text{V}^{-1}.\text{s}^{-1}$]

MW	Molecular weight [g.mol ⁻¹][Dalton]
N _{av}	Avogadro's number (6.02×10 ²³) [molecules.mol ⁻¹]
P	Pressure [bar]
P _F	pressure at inlet of the feed flow channel [bar]
P _R	pressure at outlet of the feed flow channel [bar]
P _P	Pressure at permeate side [bar]
ΔP _L	Pressure drop across the feed channel [bar]
P _m	Membrane water permeability [L.m ⁻² .h ⁻¹ .bar ⁻¹]
Q _F	Crossflow feed flow rate [L.h ⁻¹]
Q _R	Retentate flow rate [L.h ⁻¹]
Q _P	Permeate flow rate [L.h ⁻¹]
<i>r</i>	Rejection coefficient [%]
<i>r_{obs}</i>	Observed rejection coefficient [%]
<i>R</i>	Universal gas constant (=8.3143) [J.mol ⁻¹ .K ⁻¹]
R	Resistance [m ⁻¹]
R _{tot}	Total resistance [m ⁻¹]
R _m	Membrane resistance [m ⁻¹]
R _{cp}	Concentration polarization resistance [m ⁻¹]
R _{fl}	Fouling layer resistance [m ⁻¹]
R _f	Resistance of feed compartment [m ⁻¹]
R _e	Resistance of electrolyte compartments [m ⁻¹]
R _p	Resistance of permeate compartment [m ⁻¹]
R _{others}	Resistance of other items in the system [m ⁻¹]
<i>S</i>	Selectivity [-]
<i>T</i>	Temperature [K]
<i>Tr</i>	Transmission [%]

u_i	Ionic mobility [$\text{mol.m}^2.\text{J}^{-1}.\text{s}^{-1}$]
U	Applied voltage [V]
U_f	Voltage across the feed compartment [V]
U_{tot}	Total applied voltage [V]
v	Velocity [m.s^{-1}]
v_e	Specific velocity [m.s^{-1}]
V_x	Crossflow velocity [m.s^{-1}]
V_f	Volume of feed tank [m^3]
$V_{f,0}$	Initial volume of feed tank [m^3]
w	Weight of the channel [m]

Greek letters

z_i	Solute charge [-]
δ	Cake thickness [μm]
η	viscosity [$\text{g.cm}^{-1}.\text{s}^{-1}$][Pa.s]
k	convective coupling coefficient
ρ	Density [kg.m^{-3}]

Abbreviation

BSA	Bovine serum albumin
CEX	Cation-exchange membrane
dH ₂ O	Deionized water
E	Electrolyte compartment
EC	Enzyme commission number
ED	Electrodialysis

EMF	Electro-membrane filtration
EMF	Electro-microfiltration
EUF	Electro-ultrafiltration
ENP	Extended Nernst-Planck equation
F	Feed compartment
GMH	$\text{g. m}^{-2}.\text{h}^{-1}$
Glu	Glutamic acid
Glu-	Nagatively charged glutamic acid
IEF	Isoelectric focusing
Leu	Leucine
LMH	$\text{L.m}^{-2}.\text{h}^{-1}$
LP	Lipase
Lys	Lysine
Lys+	Positively charged lysine
MF	Microfiltration
P	Permeate compartment
PEG	polyethylene glycol
pI	Isoelectric point
PLA	Phospholipase
PS	Polysulfone
PVDF	Polyvinylidene-fluoride
SDS-PAGE	Sodium dodecyl sulfate polyacrylamide gel electrophoresis
UF	Ultrafiltration
+UF-&+MF-	Anode set at the feed side of UF/MF membrane
-UF+&-MF+	Cathode set at the feed side of UF/MF membrane

Preface

This project is continuing work from the previous Ph.D. work done by Enevoldsen. It was motivated by the results reported by Enevoldsen. The project was performed in collaboration between Novozymes and DTU. Enevoldsen *et al.* [1,2] demonstrated that by using an electrical field during crossflow ultrafiltration (EUF), a 3-7 times improvement in flux has been obtained. This indicates that using an overlaid electric field is an effective way to depolarize the membrane surface when operating with enzyme solutions. It is possible that application of electric field across porous membrane (MF/UF) can be used for the separation of two enzymes with opposite charge sign since enzymes can carry different charges by adjusting the pH of the solution. Another possibility is to separate the enzyme product from impurities in the solution by dragging the charged enzyme through the membrane. This could also improve the purity of the enzyme product.

The project aims at demonstrating the technological feasibility of electro-membrane filtration in the application of industrial enzyme separation. If this technology is proved to be workable, then development of pilot up-scaling and economical assessment for bulk enzyme separation as compared to current technologies will be considered.

This thesis is divided into 6 chapters. Chapter 1 reviews the membrane technology used in enzyme production or protein separation, which gives the basic concept of membrane technology and its application to protein separation. Chapter 2 describes the materials, methods and experimental set-up used in the work as well as some theoretical background of electro-membrane filtration. The results and discussion part is presented in chapter 3,4 and 5. In chapter 3, as a proof-of-concept, amino acids were used as model solution to test the feasibility of electro-membrane filtration in the application of separation of amphoteric molecule separation. In chapter 4 bovine serum albumin was used to further investigate and validate the technological feasibility of electro-membrane filtration of proteins. In chapter 5 separations of two industrial enzyme lipase and phospholipase using electro-membrane filtration was discussed. Finally the findings of the work are summarized in chapter 6 and recommendations for future work are made. The appendixes contain the information which may not be relevant for the aims of the thesis but may prove useful for anyone who may wish to repeat the work conducted.

Chapter 1

Literature review

The purpose of this literature review is to introduce the essential features and current membrane technology used on an industrial scale or lab scale demonstration in the production of partly purified or bulk enzymes, as opposed to highly purified enzymes for analytical or diagnostic use. An introduction of enzymes and their production will be given in section 1.1. The challenges and problems in conventional enzyme separation will be discussed as well. Following that, discussion about where the conventional membrane technology can play its role in enzyme production and their advantages and disadvantages as compared to other conventional recovery or separation technology will be addressed in section 1.2. A comprehensive review of pressure-driven membrane technologies on the application of protein separation will be investigated and included in section 1.3. A short introduction of crossflow membrane filtration and some key parameters in crossflow membrane filtration will be given and explained. Finally some advanced membrane technologies such as membrane chromatography and electro-membrane filtration on the application of protein separation will be discussed in section 1.4 and 1.5.

1.1 Enzymes and their production

Enzymes are proteins, which sometimes referred to as biocatalysts, have great potential for improving reactions by increasing the speed or efficiency of biochemical reactions without changing the underlying process. Enzymes are often more economical than traditional chemicals, as well as being more environmentally friendly. As a result, companies as like Novozymes A/S are investing substantial research and development effort in genetically modifying cells to produce highly focused enzymes. The most common uses of enzymes today are for detergents (stain removal), textiles (wrinkle reduction), bakery, wine, bioethanol and leather, but potential applications probably number in the thousands.

The introduction of microbial proteases into washing powders was a real breakthrough enzyme technology. The first commercial bacterial *Bacillus* protease was released in the market in 1959 and

it started being used by many detergent manufactures around 1965 [3]. Conventionally, the use of industrial enzymes has been somewhat restricted because of a high sensitivity to surrounding conditions (pH, temperature, humidity and contaminants) and storage limitations. These disadvantages are being overcome with the development of recombinant enzymes that include very specific, isolated complementary DNA strands that enable them to be highly potent and efficient. Protein engineering, molecular evolution and other new protein design techniques are increasingly being used to further refine the characteristics and performance of enzymes. Therefore, advances in biotechnology have revolutionized the commercial production of many industrial enzymes and allowed engineering of enzymes for many applications. The enzyme industry, both for commodity and specialty enzymes, is growing at a significant rate thereby creating pressure to improve the manufacturing efficiencies and economics of the harvesting and purification process steps used to produce the enzymes [4].

Presently more than 3000 different enzymes have been isolated and classified. The enzymes are classified into six major categories based on the nature of the chemical reaction they catalyze:

1. Oxidoreductases catalyze oxidation or reduction of their substrates
2. Transferases catalyze group transfer
3. Hydrolases catalyze bond breakage with the addition of water
4. Lyases remove groups from their substrates
5. Isomerases catalyze intramolecular rearrangements
6. Ligases catalyze the joining of two molecules at the expense of chemical energy

Only a limited number of all the known enzymes are commercially available. More than 75% of industrial enzymes are hydrolases including the lipase and phospholipase used in this work.

Previously, when there was virtually no enzyme industry of a type recognizable to today's biotechnologist, enzymes were extracted from animal and plant tissues. Now, most of the enzymes are produced by microorganisms in submerged cultures in large fermentors. The microorganisms used on an industrial scale for enzyme production belong to the genera *Bacillus*, *Aspergillus* or *Trico Derma* (told by Novozymes scientist). In general, the enzyme production process can be divided into following phases:

1. Selection of enzyme
2. Selection of production strain

3. Construction of an overproducing strain by genetic engineering
4. Optimization of culture medium and production condition.
5. Optimization of recovery process
6. Formulation of a stable enzyme product

Most industrial enzymes produced on an industrial scale are from microorganism belonging to the genera *Bacillus* or *Aspergillus*. The *Bacillus* species are harmless and well suited to enzyme production, and they can be grown in high concentration in fairly simple growth media. Species of *Aspergillus* is regarded as the fungal analogue of the *Bacillus* genus in the use of enzyme production. *Aspergillus* species are easily mutable. However, we have to be careful about selecting the *Bacillus* species strain whether it could form spores terminating the cell growth phase and produce antibiotics, which cannot be tolerated where enzymes are to be used in food produce.

Strain improvement is important and plays a central role in large-scale production processes because the vast majority of wild-type microorganisms are incapable of producing commercially acceptable yields. There are two principal methods of cultivation, i.e. solid-state and submerged fermentation; more information about the cultivation methods could be found elsewhere [5].

The development of new enzymes brings about the opportunity for new and improved recovery and separation processes. One of the key challenges now is to refine and optimize the manufacturing of enzymes to make their production sufficiently economical to encourage growth in their use [6].

In genetic modification of cell DNA to either implant or modify certain characteristics, scientists make use of two main types of organisms: bacteria or fungal organisms as opposed to the mammalian cells often used in the production of biopharmaceutical products for example antibodies. All use fermentation technology to grow the cells. The enzymes are typically, but not universally, extracellular, meaning they grow and are expressed outside the cells. Since the cell is intact, with the enzymes outside the cell, a physical separation is required to recover the enzyme from the cells and the fermentation broth. This is more straightforward than recovery of an intracellular compound, in which the cells must first be ruptured, creating a mixture of ingredients of multiple sizes and characteristics.

Downstream processing is one of the key factors for commercialization of new production processes. Downstream processing is usually a complicated series of isolation, recovery and purification steps which can be quite costly [7]. The following Figure 1.1 illustrates the general

routine of producing proteins/enzymes for different kind of applications. The level of processing is usually dependent on the intended application of proteins/enzymes.

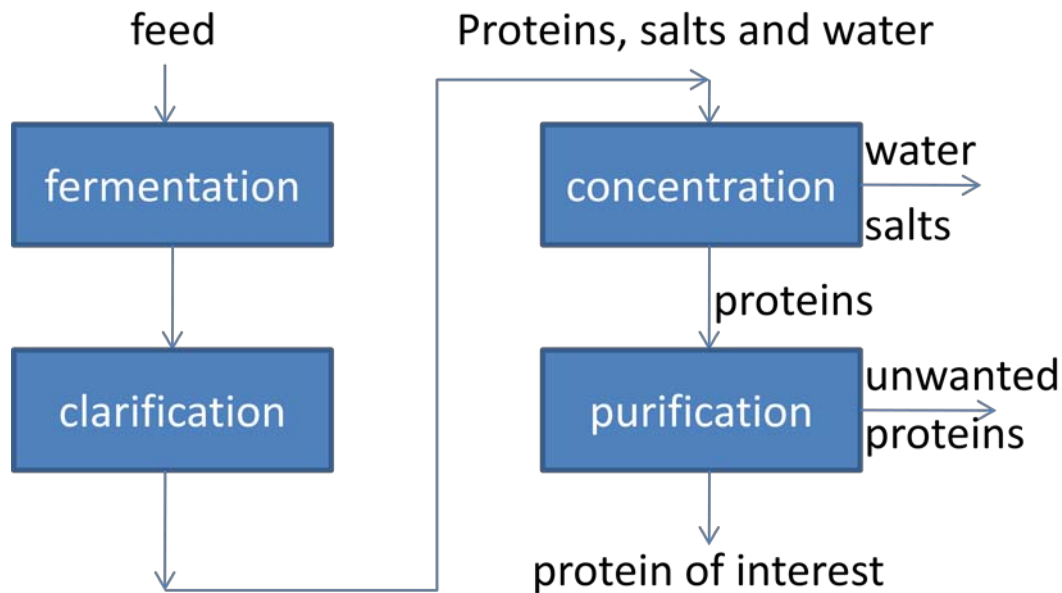

Figure 1.1 General scheme of the downstream processing in biotechnology

Downstream processing of proteins/enzymes that are produced by fermentation usually starts with the removal of cell debris, i.e. clarification. If the products produced are intracellular, clarification must be preceded by cell disruption using e.g. a homogenizer, details will be described later. Clarification of fermentation liquid is done by means of centrifugation or drum filtration. After clarification, the product is concentrated to remove most of the water using e.g. ultrafiltration (UF). By means of diafiltration, we can also remove most of the salts in the same UF system. Finally, dependent on the quality requirement and their application some of the enzymes must be purified to remove unwanted products using e.g. crystallization, precipitation or chromatographic separations processes such as ion-exchange and affinity chromatography. The higher the separation resolution of a purification step is, the more efficient a process can be. And of course, the more steps of purification involved the more cost of whole processing will be.

The level of downstream processing to which any enzyme is subjected is dependent on its intended application. Industrial enzymes produced in bulk generally require fewer downstream processing steps, and hence are relatively crude preparations. Enzymes destined for therapeutic applications are

subject to a far higher degree of downstream processing, often incorporating 3–4 chromatographic steps.

The level of downstream processing to which any enzyme or other protein is subjected is largely dependent on the intended application of the finished product [8,9]. On this basis, most proteins can be categorized into three groups [10]

(a) bulk industrial enzymes such as amylases (EC 3.2.1.1 and EC 3.2.1.2), lipases (EC 3.1.1.3) and proteases (EC 3.4)

(b) enzymes utilized for diagnostic purposes - examples include glucose oxidase (EC 1.1.3.4) and cholesterol esterase (EC 3.1.1.13), which are used in the determination of blood glucose and cholesterol respectively

(c) enzymes used for therapeutic purposes

Bulk industrial enzymes (sometimes refer to partly purified or refined products) are subject to the least stringent downstream processing procedures. The majority of such enzymes are extracellular, produced by methods of fermentation and the general strategy used in their downstream processing is outlined in Figure 1. 2.

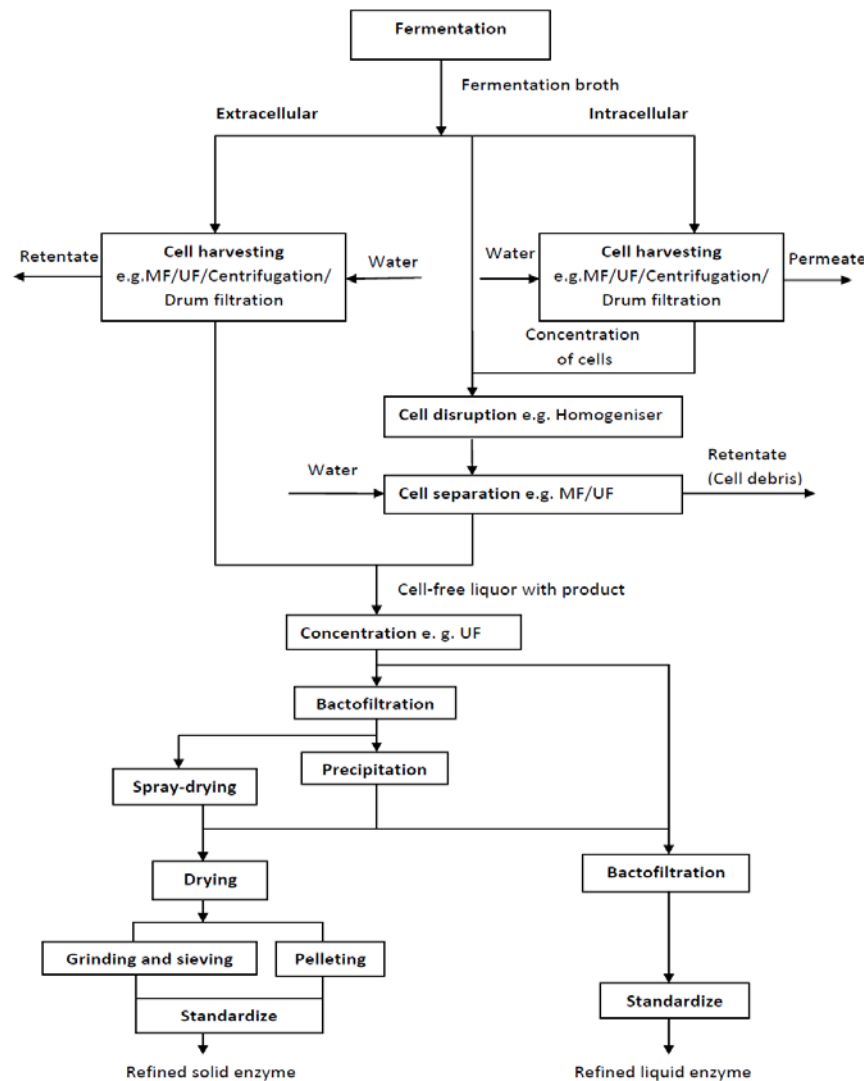

Figure 1.2 Downstream processing scheme applied in the production of bulk industrial enzymes, modified based on Lambert and co-workers [5]

As indicated in Figure 1.2, the main step in any enzyme recovery process involves: (1) cell harvesting by using either filtration or centrifugation. Cell disruption using homogenizer is used if the product is intracellular enzyme. After this stage a second solid-liquid separation is required to remove cell debris and produce clarified liquor for subsequent enzyme recovery. (2) preparation of concentrated enzyme by ultrafiltration or evaporation. (3) bactofiltration (or polish filtration) of concentrated enzyme to remove the bacteria or other microorganisms which may exist in the concentrated enzyme solution. (4) simple or multiple precipitation processes may be used when a fair degree of purity is desired in the final product (5) mixing the bactofiltrated crude liquid enzyme with stabilizers and preservatives, and adjusting the activity to the specified value. (6) spray-dry the

clear bactofiltrated enzyme solution in vacuum ovens or fluidized bed driers to the required moisture levels if a solid enzyme is required. The simplest way of preparing a commercial product is to grind the enzyme into a fine powder, sieve and standardize the activity by the addition of suitable diluents. (7) coating the spheres with a layer of wax. In this way it is possible to obtain a uniform particle size with minimum dust formation. Detailed description can be found elsewhere [5].

Many enzymes utilized for diagnostic purposes are generally subjected to at least limited steps of chromatographic purification. In such cases purification is required to remove any additional enzymatic activities which may interfere with the diagnostic functioning of the final product.

Enzymes destined for therapeutic application, in particular those destined for direct administration by injection or infusion, are subjected to the most stringent downstream processing. Many of the initial steps utilized in the downstream processing of such products are similar to those outlined in Figure 1.2, the product is generally subjected to several chromatographic steps after the primary concentration steps. Generally a combination of at least three different chromatographic steps are used, the most common of which are gel filtration, ion exchange and hydrophobic interaction chromatography. The final protein product generally should be at least 95-98% pure. Downstream processing of enzymes destined for therapeutic administration by injection should not only remove additional contaminating proteins but should effectively remove additional substances such as viral particles and endotoxins which would otherwise compromise final product safety.

1.1.1 Conventional enzyme purification technologies and challenges

In this part, we will be discussing about some traditional purification technologies (liquid-liquid purification other than solid-liquid separation) used in enzyme production and limitation and challenge we might have when using those technologies in the process of enzyme production. As said, dependent on the quality requirement and their application some of the enzymes must be purified to remove unwanted products using e.g. precipitation, crystallization or chromatographic separations.

Precipitation of enzymes is a useful method of enzyme purification and is ideal as an initial step in enzyme purification process. It can be easily used on a large scale. Salting-out of proteins by using of ammonium sulfate is one of the best known and used methods for separation of enzyme from the contaminating proteins. The increase of ionic strength of the solution causes a reduction in the

repulsive effect of the proteins with similar charges. It also reduces the forces holding the solvation shell around the protein molecules. When the forces are sufficiently reduced, the protein will precipitate. However, precipitation with ammonium sulfate is limited as it is corrosive to metals and concrete, it forms dense solutions presenting problems to the collection of the precipitate. In addition, some enzymes do not survive in ammonium sulfate precipitation. An alternative is to use organic solvent such as methanol, ethanol and acetone, which enable proteins to react more closely with each other resulting in subsequent precipitation. Besides the fact that organic solvents are not environmentally friendly, enzyme denaturation may occur due to protein folding into an inactive form. Also, the fact that precipitating salt or solvent has to be removed by dialysis, UF or gel filtration which brings more budget to the whole process [11]. Most importantly, precipitation is not considered as a very selective way to separate proteins. Proteins in the solution are normally precipitated all together. Other disadvantages like precipitation may be affected by the addition of inorganic salts or organic solvents; low temperature (often below zero) has to be maintained to avoid adverse enzyme structural changes should be taken into account. Last but not least, the capital cost of equipment tends to be high because of the mandatory requirement to protect against potential explosion hazards by providing necessary protective systems.

Crystallization is the formation of solid enzyme particles of defined shape and size. As compared to precipitation for the application of enzyme purification, crystallization is more selective separation technique. Much of the emphasis in enzyme crystallization has focused on obtaining crystals for X-ray diffraction analysis rather than as a purification process. However, crystallization is attracting interest as a purification process in enzyme production. To the best of my knowledge, it has been used for the purpose of enzyme purification from bulk fermentation in Novozymes. The challenge remains to obtain high yield crystallization. Figure 1.3 shows the steps involved in the crystallization process for an industrial enzyme [12]. The desired characteristics of industrial scale enzyme crystallization are product purity, process yield, ease of crystal recovery and short overall process time. To achieve these aims, the crystallization process must be carefully designed and developed to produce crystals with relatively large size and desired morphology. Many factors, including salt type and concentration, pH, temperature, the presence of variable amounts and types of impurities, mixing, and crystal seeding can affect enzyme crystallization. Controlling the level of supersaturation throughout the crystallization process is essential for optimization of crystal size, which can be controlled by use of precipitants such as salt, pH and temperature. Temperature plays

a key role in the rate of enzyme crystallization [12]. The biggest problem of crystallization is that sometimes it is hard to get seed crystal.

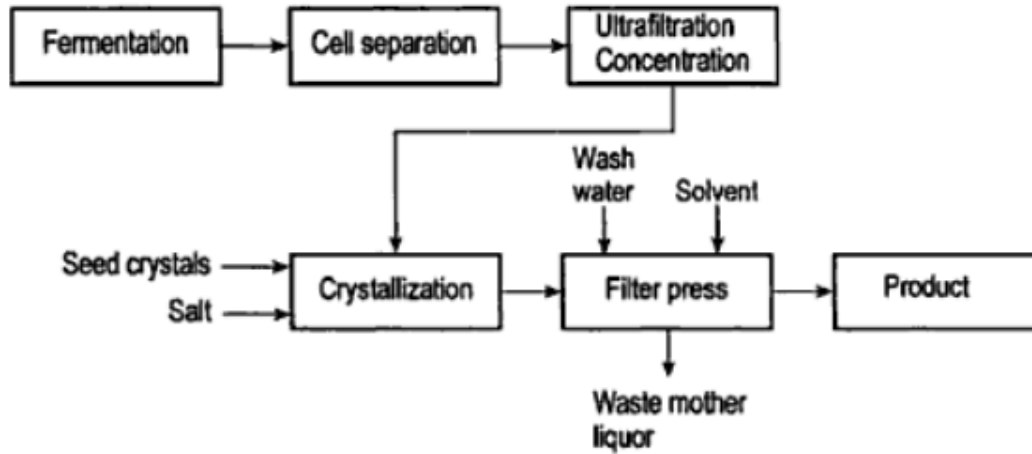

Figure 1.3 Industrial-scale halide salt crystallization of subtilisin, taken from the book of Wolfgang [12]

For the high quality enzyme purification especially enzymes used for pharmaceutical purpose, chromatography is of fundamental importance. Chromatography for bulk enzyme production is too costly. Protein molecules are separated according to their physical properties (size, shape, charge, hydrophobic interactions), chemical properties (covalent binding), or biological properties (biospecific affinity) [13].

Gel chromatography (also gel filtration), in which hydrophilic, cross-linked gels with pores of finite size are used in columns to separate protein molecules. In gel chromatography, molecules are separated according to size and shape. Molecules larger than the pores of the gel cannot enter the gel and therefore are eluted first. Smaller molecules, which enter the gel are retarded in their passage through the column and spend longer time therefore eluted later than the larger molecules. The basic principle of gel chromatography is also depicted in Figure 1.4

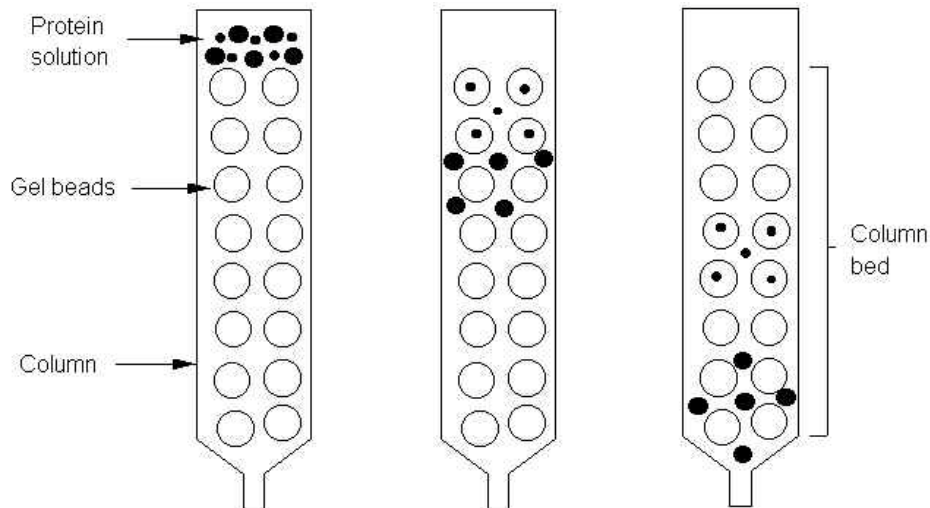

Figure 1.4 Diagrammatic representation of gel chromatography

Ion-exchange chromatography is a separation technique based on the charge of protein molecules. Enzyme molecules can positively or negatively charged depending on the solution pH, and this property is used to separate them by chromatography on anion exchange resin (positively charged) or cation exchange resin (negatively charged). Enzymes are eluted from the column by changing the pH of the elution buffer, so changing the charge on the proteins or changing the ionic strength of the buffer solution so changing the ionic interactions between the enzymes and the ion exchange resin.

Hydrophobic chromatography is based on the interaction of hydrophobic areas of protein molecules with hydrophobic groups on the matrix. Adsorption occurs at high salt concentrations, and fractionation of bound substances is achieved by eluting with a decreasing salt gradient. This method is suited for further purification of enzymes after concentration by precipitation with salts such as ammonium sulfate.

In affinity chromatography, the enzyme to be purified is specifically and reversibly adsorbed on a ligand attached to an insoluble support matrix. Suitable ligands are substrate analogues, enzyme inhibitors, dyes, metal chelates or antibodies. The basic principle is, the biospecific ligand attached to the matrix specifically binds the complementary enzyme, unbound substances are washed out and

the enzyme of interest is recovered by changing the experimental conditions, for example by altering pH or ionic strength.

Column chromatography techniques on large scale are normally easy and straightforward. However, large-scale economic purification of proteins is increasingly becoming an important problem for the biotechnology industry. In the processes of enzyme purification, an enzyme concentrate produced by fermentation will often contain two or more enzyme activities. From the application viewpoint it is necessary to remove the side activity. Traditionally, separation of the desired protein from other proteins produced by the cell is usually attempted using a combination of different chromatography techniques which normally are very expensive in terms of equipment, resin, buffer and yield loss. High purity is often not achieved unless several purification steps are combined thereby increasing cost and reducing product yield. In addition, time associated enzyme deactivation and temperature sensitivity etc. are sometimes found to be problematic.

Consequently there is a need for processes that purify protein mixtures using fewer steps and without the need for a costly affinity step.

1.2 Membrane technology in enzyme production and challenges

Due to the unique properties of membrane, upscaling and downscaling of membrane processes as well as their integration into other separation processes are easy. Therefore, membrane technology is increasingly being used in enzyme concentration, buffer exchange and clarification and recovery schemes for the production of enzymes. Applications of membrane technology in enzyme production can be enumerated as following:

1. Used in solid/liquid separation to remove cells or cell debris from fermentation broth. In most industrial enzyme production, this could be the first separation step of using membrane to remove the suspended cell mass and other colloidal debris from the aqueous suspending medium. The membranes used in this step can be either MF or UF membranes. Other traditional means of solid/liquid separation can also be drum filtration or centrifugation.
2. Used in concentration of enzyme by UF. Most enzyme fermentation processes yield their products in high dilution in the culture medium. Therefore it is essential to find a simple and economic process which can be used to increase the product concentration, and reduce the

liquid volume. And this also must be handled before the subsequent processing steps. Direct UF filtration of the dilution crude enzyme solution provides a rapid and convenient means for accomplishing this concentration process. Normally, concentration factors of 10 to as much as 100 fold can be obtained with little to no product-loss by denaturation. An additional benefit achieved by UF concentration is the simultaneous removal of electrolytes and low-molecular weight metabolites whose presence may complicate subsequent purification.

3. Used in macrosolute/microsolute separation, sometimes in enzyme production, solutions containing mixtures of macro- and microsolute are generated. In most cases, the macrosolute component (enzyme) is the desired product; therefore the microsolute (such as peptides) have to be removed. UF will be the preferred method to retain the macrosolutes. Good purification can be achieved by continuous, multistage cascaded diafiltration [14].
4. Used in fractionation of different enzyme activity, however to the best of my knowledge, it is rare that membrane technology is used for the purpose of fractionation of different enzyme in an industrial scale. This attempt is not adopted mainly due to solute-solute and solute-membrane interactions which jeopardize the efficiency of the separation. Furthermore, traditionally fractionation using UF is limited to the variation in size of the enzymes and only when the difference are in the order of 10 or more a reasonable separation factor can be observed. This is partly caused by concentration polarization and membrane fouling which hinders an effective separation of the proteins based on size.

In generally, some of the limitations of membrane technology in enzyme production can be pointed out [15]: (1) low permeation flux (2) inadequate membrane durability or lifetime (3) membrane fouling (4) high operating costs (5) inadequate selectivity.

1.3 Pressure-driven membrane technology for protein/enzyme separation

In this part, we are mainly reviewing the pressure-driven membrane technology for protein/enzyme separation. During the last three decades, membrane-based separation processes have attracted the attention in chemistry, chemical, biotechnological and pharmaceutical fields due to selective transport and efficient separation in comparison to other unit operations. Membrane-based

separation processes gained importance in proteins separation due to their ability of separating protein based on size and charge [16-19]. Solute-solute and solute-membrane interactions which can jeopardize the efficiency of the separation may hinder the adoption of membrane-based process for protein separation. However as compared to the advantages one can gain from membrane-based separation processes, this is minor. Membranes have conventionally been used for separation of proteins based on size difference. Reasonable selectivity can be obtained when the difference is in the order of 10 fold. Essentially all membrane processes can be used for protein separation. However the greatest interest has been still in the application of the pressure-driven membrane technology such as MF, UF and NF. MF membranes are especially suited for the separation of particles in the size range of 0.1-10 μ m. An important application of MF is to separate viruses from proteins [20]. While UF membranes usually with 1-100 nm pore size which are designed to provide high retention of proteins and other macromolecules [17,21]. A very common application of UF in downstream processing is for concentration of protein solutions. Examples of UF membrane processes involved the filtration of protein solutions with electrolytes present, concentration of whey proteins in the dairy industry, protein recovery from blood plasma, protein concentration in downstream processing such as industrial enzyme production [22]. NF is particularly useful for separation of peptides due to the suitable cut-off and to charge property of NF membrane, which plays an important role in the application of separating charged molecules. Several papers have reported the application of peptides and amino acids separation using NF membrane based on sieving effect or charge effect on the membrane type and feed composition [23-25]

1.3.1 General concepts and definitions of crossflow membrane

filtration

Crossflow membrane filtration is a pressure driven membrane process where the feed flows parallel to the membrane surface with only a fraction of the liquid volume permeating the membrane due to the trans-membrane pressure (TMP) as Figure 1.5 shows. Through various mechanisms, depending on the size of the molecules or particles, crossflow reduces the accumulation of materials on the membrane surface in contrast to dead-end filtration, therefore allowing filtration to continue.

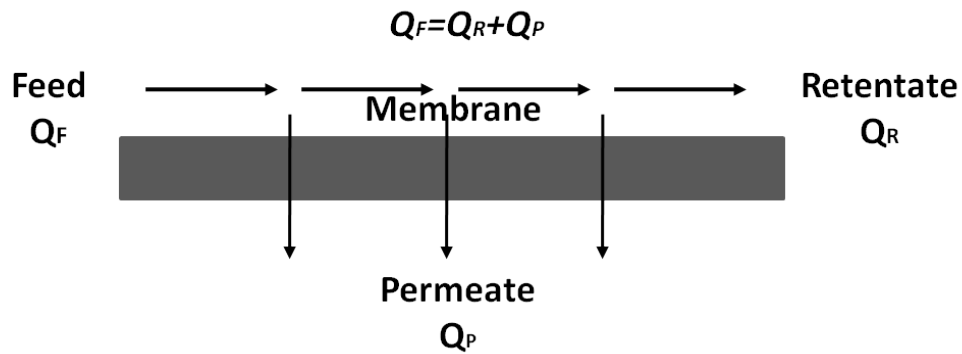

Figure 1.5 General scheme of crossflow membrane filtration

There are a few common flow schemes which represent the majority of processes, such as batch concentration mode, fed-batch concentration mode, continuous concentration mode and diafiltration mode. Batch concentration mode and continuous mode will be discussed in the following text due to the fact that batch mode is used in our studies and continuous mode is commonly used in the industrial production of enzyme because of low retention time which favors the enzyme stability

The most common representation is of a simple batch concentration system is presented in Figure 1.6. In batch concentration mode, the feed is recirculated between the feed tank and the membrane module, with permeate collected in the permeate vessel. A common variation of the batch mode is the fed-batch mode, which is not presented here. As compared to fed-batch mode, the simple batch mode is generally the most efficient, because the membrane is exposed to the lowest possible material concentration to achieve a given final concentration, usually can result in higher average flux than fed-batch mode [26].

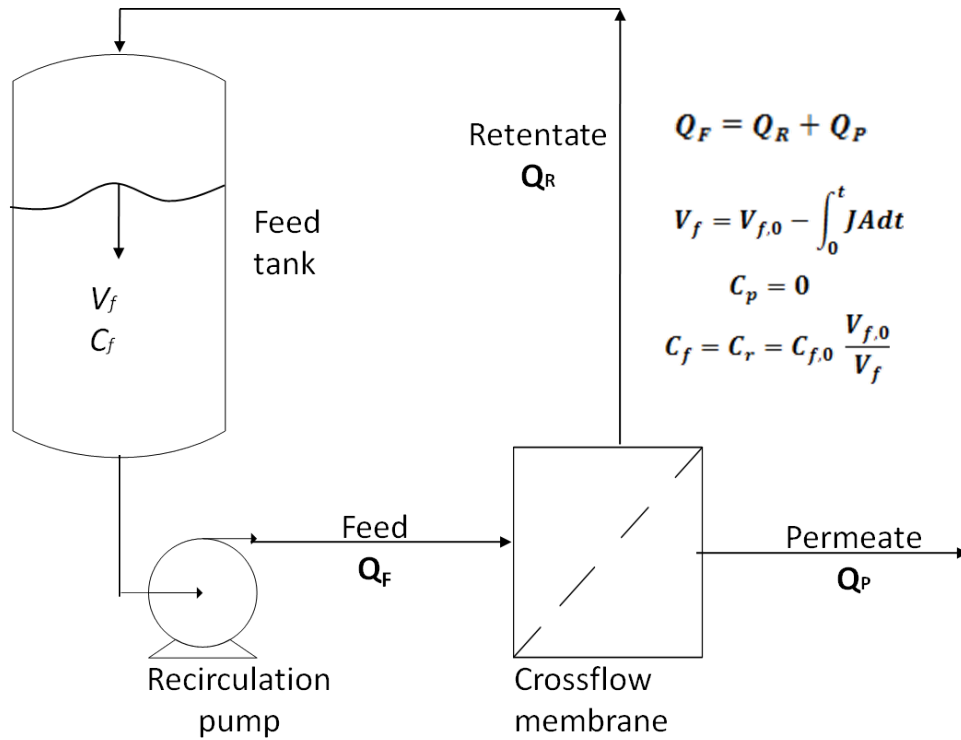

Figure 1.6 Diagrammatic of batch concentration mode

Continuous crossflow filtration as shown in Figure 1.7 is commonly used in the concentration step of enzyme recovery as the enzyme solution from primary recovery step such as centrifugation or drum filtration is pumped continuously to the UF concentration plant. For more detailed discussion of the different operating schemes, one can refer to elsewhere [21,27].

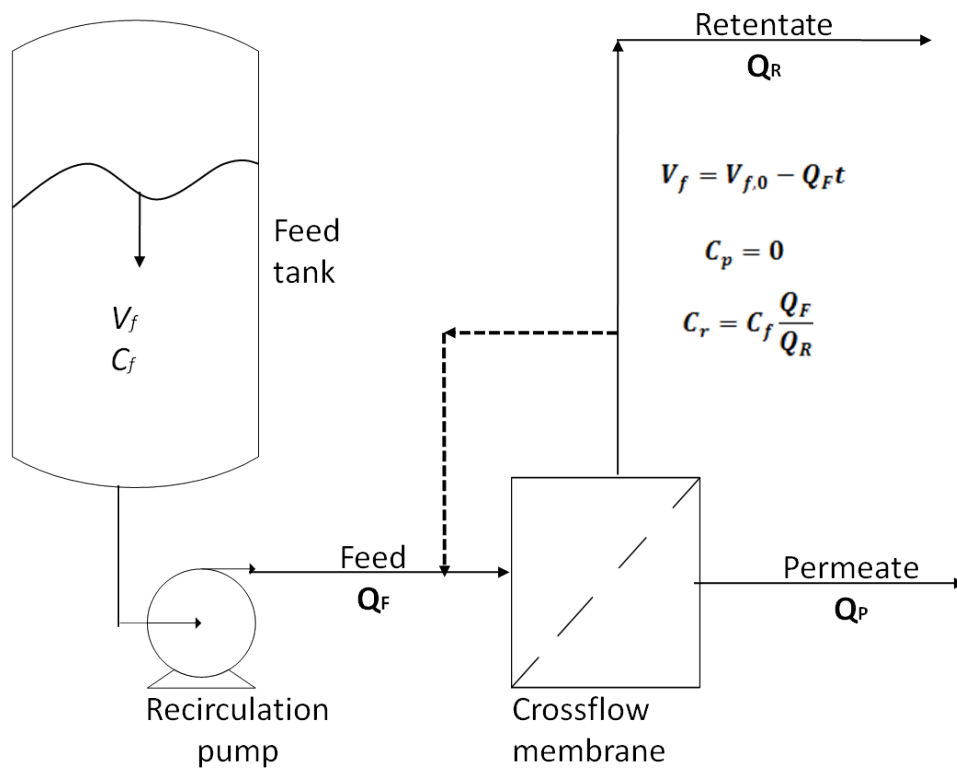
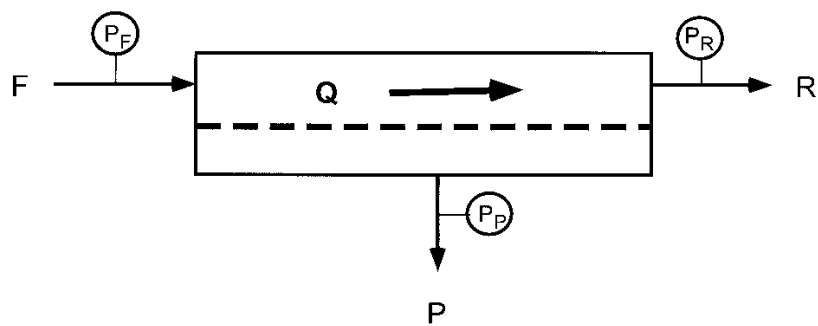

Figure 1.7 Diagrammatic of continuous concentration mode

It is essential to clarify and understand several key parameters in crossflow membrane filtration. The sketches provided in Figure 1.8 combined with the definitions in crossflow membrane filtration.



$$\text{Retentate Pressure Drop, } \Delta P_L = P_F - P_R$$

$$\text{Transmembrane Pressure Drop} = \text{TMP} = \Delta P_{TM} = (P_F + P_R)/2 - P_P$$

(A)

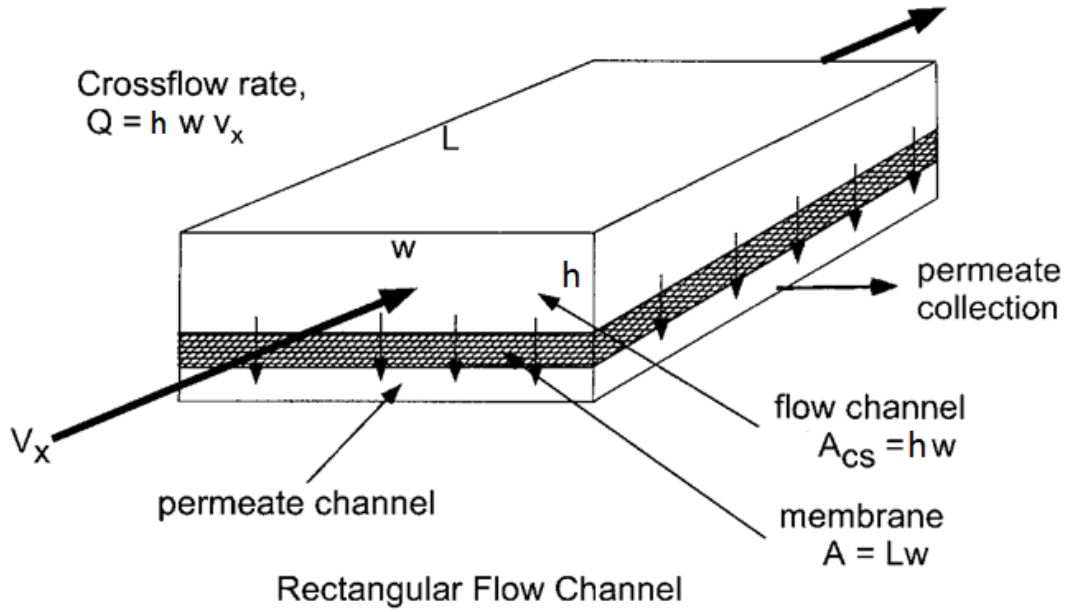

(B)

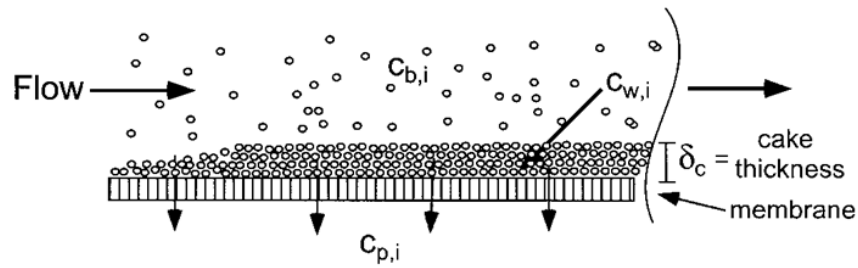

$C_{b,i}$ = concentration of i in bulk fluid

$C_{w,i}$ = concentration of i at membrane wall

$C_{p,i}$ = concentration of i in permeate

Permeation Coefficient, $\tau_i = \frac{C_{p,i}}{C_{b,i}}$

for $0 \leq C_{p,i} \leq C_{b,i}$

$0 \leq \tau_i \leq 1$

Retention Coefficient, $r_i = 1 - \tau_i$

or $r_i = 1 - \frac{C_{p,i}}{C_{b,i}}$

for $0 \leq C_{p,i} \leq C_{b,i}$

$1 \leq r_i \leq 0$

(C)

Figure 1.8 Definitions in crossflow filtration: (A) basic parameters; (B) membrane geometries; (C) characterizing the permeation of soluble components, modified based on Russotti *et al.* [26]

Like its parent technology dead-end filtration, crossflow filtration is a pressure-driven process. A pressure gradient through the membrane pores, characterized by TMP drives the flow of solvent and permeable materials across the pores. Impermeable and semipermeable solutes are transported to the membrane surface or into the pores by convective transport by flow across the pores. Eventually as they accumulate there, then they present an additional resistance to flow. Crossflow of bulk fluid across the membrane surface during filtration is employed to disrupt this accumulation at the membrane surface, minimizing resistance and enhancing flux. Two well studied models, gel layer model and osmotic pressure model are commonly used to describe the filtration flux. More details can be found elsewhere [1,21].

Table 1.1 lists the common terms encountered in the crossflow membrane filtration and some are also used in this thesis.

Table 1.1 Common parameters and definitions in crossflow membrane filtration

Parameter	Symbols	Units	Definition
Flux	J	$L \cdot m^{-2} \cdot h^{-1}$ or LMH, cm/s	Bulk fluid flow rate through the membrane relative to membrane area. 1 LMH= 2.78×10^{-5} cm/s
Pressure (feed, retentate, permeate)	P	bar, kPa	Pressure measured at the entrance and exist of the feed flow channel (P_F , P_R), and on the back side of the membrane (P_P)
Transmembrane pressure	TMP	bar, kPa	Pressure drop along across the membrane: for average value, $TMP = (P_F + P_R) / 2 - P_P$
Retentate pressure drop	ΔP_L	bar, kPa	Pressure drop across the feed channel, $\Delta P_L = P_{in} - P_{out}$
Flow channel dimensions	h, w, L	m	Height, width and length for rectangular channels
Membrane surface area	A	m^2	Membrane surface area for

Cross-section area	A_{cs}	m^2	filtration Cross-sectional area for fluid flow in the membrane flow channels: $A_{cs} = h \times w$
Crossflow rate	Q_F	$L.h^{-1}$	Bulk fluid flow rate in the membrane flow channels
Crossflow velocity	V_x	m/s	Average velocity of bulk fluid flow through the membrane flow channel: $V_x = Q/A_{cs}$
Membrane pore size	d_p , MWCO	μm , kDa	Usually microfiltration membranes pore size characterized by diameter; ultrafiltration membranes characterized by MWCO
Suspension viscosity	η	$g.cm^{-1}.s^{-1}$, cP	$1 g.cm^{-1}.s^{-1} = 1 \text{ Poise(P)} = 1 \text{ Pa.s}$
Cake thickness	δ	μm , mm	Thickness of the compressed layer at the membrane wall, usually considered to be the boundary layer thickness in mass transfer modeling
Resistance (total, membrane, concentration polarization layer, fouling layer)	R , R_{tot} , R_m , R_{cp} , R_{fl}	m^{-1}	Proportionality factor relating flux and TMP: $J = TMP / \eta R$
Membrane hydraulic permeability (water permeability)	P_m	LMH/bar	Change in flux with a change in TMP for pure water
Permeability coefficient (Transmission)	Tr_i	Fractional	Fraction of a soluble component in the permeate relative to its concentration of the bulk solution
Retention (Rejection)	r_i	Fractional	Fraction of a soluble component which is retained by a membrane, relative to its concentration of the bulk

1.3.2 Protein separation by microfiltration

MF membranes are especially well suited for the separation of fine articles in the size range of 0.1-10 μ m. It is widely used for the separation and clarification of protein-containing solutions, e.g. for the recovery of extracellular proteins produced by fermentation and for the removal of bacteria and viruses in the final formulation of therapeutic proteins. In all these processes the size of the macromolecules and proteins involved are much smaller than the pores of the MF membrane and they should therefore pass through the MF membrane easily [28].

A large number of MF applications are reported to perform pretreatment, remove small molecules from bigger molecules, clarify suspensions for cell harvesting, and remove viruses and bacteria for sterilized liquids [17,29]. Separation of soluble protein from inclusion bodies in *Escherichia coli* cell lysate using crossflow microfiltration in a diafiltration mode was reported, 84% of the protein was removed [30]. Espina *et al.* investigated the separation of α -lactalbumin and β -lactoglobulin from casein micelles during MF of skim milk using a dynamic filtration pilot (MSD) equipped with six rotating ceramic membranes of 0.2 μ m pores [31]. Separation of BSA from yeast/BSA binary suspension was performed with cross-flow MF filtration by Hwang *et al.* [32]. They reported that at pH 3.0, high cross-flow velocity and low filtration pressure is the optimum operating condition for purification of BSA from the binary suspension. Ghosh and co-workers discussed an integrated one-step bioseparation technique for separation of human plasma proteins HSA and HIgG. This technique combined three separation processes, i.e. (a) ammonium sulfate induced precipitation, (b) microfiltration, and (c) membrane adsorption, all of which were carried out simultaneously within the same membrane filtration device. MF was incorporated into this process which was to retain HIgG by two mechanisms and allow HAS to pass through the membrane. The antibody fraction precipitated by ammonium sulfate was retained by a sieving mechanism while the antibody fraction remaining in solution was retained by hydrophobic interaction based membrane adsorption. Nearly complete separation of HSA and HIgG could be accomplished in just one step. Using this integrated bioseparation technique, more than 96% purity of HSA and HIgG fractions were obtained while the recoveries were in excess of 95% respectively [33]. Crossflow MF with backpulsing was successfully used in protein recovery from bacterial lysate and proved to be an effective method for protein recovery, 100% protein transmission with backpulsing was obtained as compared to only 60% in average transmission in the absence of backpulsing [34].

Severe membrane fouling often happens in MF application, which reduces the flux and protein transmission. The effect of concentration polarization in MF processes can be quite severe because normally in MF filtration the flux is high and the mass-transfer coefficients are low as a result of the low diffusion coefficients of macromolecular solutes. A lot of works have been devoted to developing new membrane modules with improved mass- transfer characteristics for MF processes, which include rotating disk filters, cylindrical Taylor vortex devices, conically shaped rotors, helical coiled Dean vortex systems and high frequency back pulsing [35-42]. The ideas of those new modules are to increase the protein transmission, improve flux and reduce fouling.

1.3.3 Protein separation by ultrafiltration

Ultrafiltration has been widely used for protein concentration and buffer exchange, and gradually replaced size exclusion column chromatography in these applications [43]. UF is also becoming a powerful bioseparation process for purification and polishing of bioproducts such as therapeutic drugs, enzymes, hormones, antibodies, etc. Protein retention in UF has traditionally been seen as a purely size-based exclusion phenomenon. The choice of membrane is usually guided by its molecular weight cut-off (MWCO), which is defined as the equivalent molecular weight of the smallest protein that would be rejected above 90% (measured at given conditions of TMP, crossflow velocity and temperature).

UF membranes with different materials have been used successfully in the application of protein separation. Ghosh *et al.* succeeded purifying lysozyme from chicken egg while using hollow-fiber polysulphone (PS) UF membrane (30 kDa MWCO) [44]. Separation of β -lactoglobulin from whey protein concentrate was achieved by using two-stage UF with polyethersulfone (PES) membrane (30 and 10kDa MWCO) in stirred rotating disk module followed by ion-exchange membrane chromatography [45]. Other types of polymeric UF membranes such as polyacrylonitrile membrane [46], cellulose acetate membrane with 30kDa [47] and ceramic membrane with 300kDa [48] were extensively investigated for protein separation.

Traditional UF separation of protein is based on the size difference of the processed proteins. Recently, some studies have demonstrated the potential of exploiting both size and electrostatic interactions for improved UF processes [49,50]. It is now evident that UF is not a separation process

solely based on size. It is in fact possible to separate proteins having similar molecular weight, which expands UF application in protein separation. This phenomenon is due to the physicochemical interactions occurring between the UF membrane and the solutes.

Recently, development of advanced technique with low membrane fouling, high selectivity and permeate flux has been studied extensively with charged UF membrane. As compared to normal UF membrane which might also display charge property, charged UF membrane is modified with functional compounds and therefore display a more distinct charge effect. A positively or negatively charged UF membrane with definite pore structure and MWCO is generally used for selective protein separation because of high interactions between transporting species and membrane surface with extremely low fouling due to electrostatic repulsion between membrane surface and foulants. pH and ionic strength of the feed solution are adjusted to control the charge on the proteins. Although protein concentration by UF has become a successful unit operation in biotechnology, fractionation of proteins using UF is still a technological challenge and its effectiveness and efficiency are strongly dependent on operating parameters such as pH, salt concentration, permeate flux, and system hydrodynamics. Zydney and co-workers have done extensively research on electrostatic interactions between charged proteins and charged membranes and demonstrated that pH values and ionic strengths have profound effects on protein separation [51-53]. Nystrom *et al.* studied charged UF membranes and separated enzymes from fermentation broth and myoglobin from BSA [54,55]. They reported that high selectivity was achieved for the smaller protein at its pI. It was mentioned that the optimal pH for fractionation was that one protein had its pI at this pH thus permeated the membrane, while the other one was held back in the retentate because of charge repulsion with the membrane. The charged protein has an increased diameter compared with an uncharged one and needs a bigger pore to transport the membrane [56].

Many papers have been reported on protein separation with charged UF membrane and effects of solution pH and ionic strength on separation performance. Fractionation of myoglobin and cytochrom C was carried out with positively (sulphonated) and negatively charged (aminated with quaternary group) PES UF membranes near to pH equal to pI of one of the proteins by Nakao and co-workers [57]. They reported that high transmission of the neutral protein and strong electrostatic repulsion of the charged protein with the membrane were observed. This observation opened up exciting new opportunities for exploiting electrostatic interactions in the optimization of membrane

systems for protein separation. Fractionation of lysozyme and chicken egg white by UF was investigated using commercially available negatively charged membranes made of by regenerated cellulose or PES with 30 kDa MWCO. In optimized conditions, 99% lysozyme transmission with 2400 folds selectivity was obtained [58]. It was reported by Ghosh *et al.* [59] that the selectivity was very dependent on the solution pH in the studies of BSA and lysozyme fractionation by a PES UF membrane (50kDa MWCO). The selectivity varied from 3.3 at pH 5.2 to 220 at pH 8.8. van Eijndhoven *et al.* [60] demonstrated that it is possible to improve the selectivity of available membrane systems by exploiting the different electrostatic interactions between the two proteins and the membrane. Selectivity values of more than 70 for haemoglobin and BSA separation using 100kDa PES membrane was obtained just by reducing the salt concentration and adjusting the pH to 7 near the pI of haemoglobin. This very high selectivity was a direct result of the strong electrostatic repulsion of the charged albumin from the membrane. Electrostatic effect due to pH and ionic strength on separation performance was also reported by Saksena *et al.* [61], they reported that the selectivity values varied from 2 to 50 in the studies of fractionation of IgG and BSA using 100kDa and 300kDa MWCO PES membrane in a stirred cell module. The effects of membrane charge and solution pH on filtration of the major whey proteins α -lactalbumin (14.1 kDa) and β -lactoglobulin (18.4 kDa) using functionalized PES UF membranes was studied [62], it was reported that the charged membrane gave five times better selectivity than the unmodified membrane at pH 7.2, the enhanced selectivity of the tailor-made membrane was attributed to the increased retention of β -lactoglobulin due to a reduction in molecular sieving effect combined with electrostatic repulsion between negatively charged β -lactoglobulin and the negatively charged membrane. Development of inorganic charged UF membranes with greatly enhanced chemical, thermal and mechanical stability was also motivated by some researchers [63,64]. Shah *et al.* [63] synthesized nanoporous carbon UF membranes from a polymeric precursor mixture of poly (ethylene glycol) (PEG) and poly (furfural alcohol) (PFA). These membranes were stable even after long time exposure to 3 N NaOH solutions. BSA sieving coefficient ($T_r=0.62$) through this nanoporous carbon UF membrane at a flux of 60LMH was a factor of six larger than that through a 100kDa Biomax membrane ($T_r=0.1$). Better separation in terms of stronger stability and higher selectivity can be expected by using the inorganic charged membranes.

1.3.4 Protein separation by nanofiltration

NF is particularly useful and promising separation technique for separation of peptides contained in enzymatic hydrolysate due to the suitable cut-off and to the charge property of the NF membranes, which play an important role in the case of charged molecules [65]. NF offers the possibility of separating solutes through a combination of size and charge effects. Many papers have reported that the extent of electrostatic interactions between peptides or amino acids and NF membranes, which is determined by pH and ionic strength, and can influence their transmission during filtration experiments [24,25,66-70].

A negatively charged NF membrane was applied to concentrate cationic peptides with antibacterial properties from cheese whey protein [69]. A preliminary study on the desalting of peptide fractions from whey protein hydrolysate using NF membranes has shown the possible occurrence of specific rejection phenomena involving negatively charged peptides by NF membranes [71]. Pouliot et al. [68] have studied the fractionation of peptides from tryptic hydrolysates of whey proteins with charged NF membrane. In this study, a 2500Da cut-off cellulose acetate membrane, reported to have negative surface charge characteristics at basic pH values, revealed selective transmission of positively charged peptides over negatively charged ones at pH 9.0 without NaCl added. However, the charge of membrane would not be the only factor affecting the selectivity of the fractionation process of peptides during NF. Garem *et al.* [67] suggested that the presence of high molecular-weight negatively charged peptides in the concentration polarization layer could influence the selectivity of the NF membrane. Accumulation and/or adsorption of these peptides on the surface of the membrane would increase the charge density of membrane and in turn affect transmission of the smaller positive or negative peptide. But it was not clear from this study that how the transmission of different peptides can be affected by the extent of concentration polarization.

1.4 Membrane chromatography and its application to protein separation

Membrane chromatography has been studied for many years as an alternative to conventional column based chromatography [72-74]. It has demonstrated its ability, efficiency and time stability for high resolution of protein separation.

In membrane chromatography, specific ligands are grafted onto the pore surface in membranes and then target biomolecules are adsorbed on these ligands during the convective flow through the membrane pores [74-78]. This technique is based on reversible biospecific interactions between the protein and a specific ligand leading to the change of protein properties thereby separated from protein mixture. For successful operation of this technique, three basic requirements have to be taken into account.

1. A biospecific ligand must be available for target molecule to be separated
2. The ligand must have reactive chemical groups for its covalent attachment to membrane matrix
3. The membrane matrix should be easily attached.

The principle of membrane chromatography is shown in Figure 1.9.

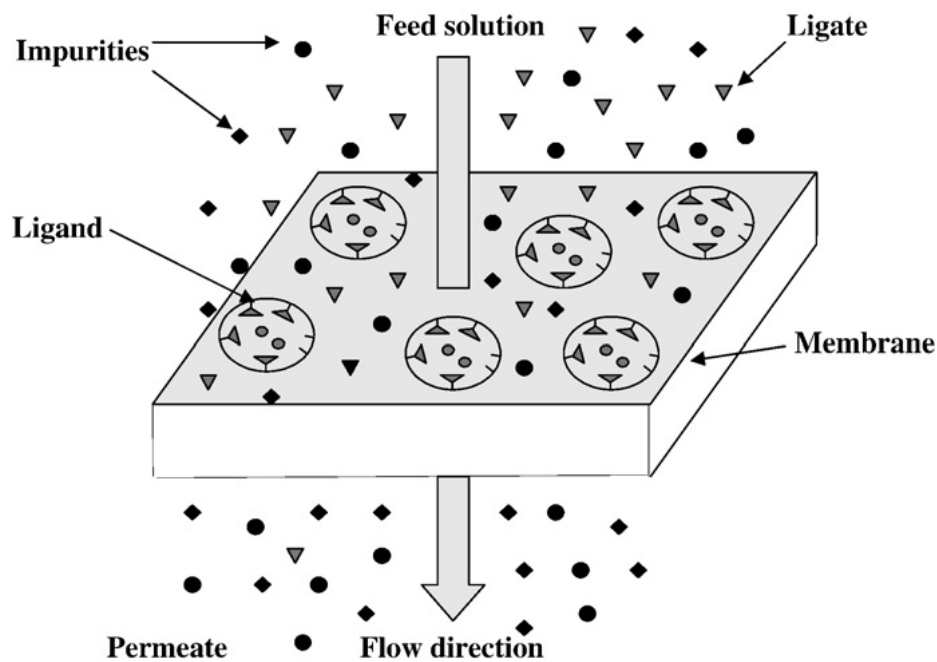

Figure 1.9 Principle of membrane chromatography, taken from Saxena [79]

As can be seen in Figure 1.9, ligands are immobilized on the porous surface of the membrane and the mixture containing the protein of interest is passed through the membrane. A specific interaction takes place between ligand and ligate (protein of interest) which retains the desired protein on the matrix support, while the other feed components transport through the membrane. The protein is eluted with a specific buffer, either by pH and/ or ionic strength shift or by competitively displacement elution as normal column affinity chromatography [80].

The distinct benefit of membrane chromatography is the shorter diffusion times than those obtained in column chromatography, as the interactions between biomolecules and ligands on the membrane occur in convective through-pores, rather than in stagnant fluid inside the pores of an adsorbent resins (Figure 1.10). For this reason, membrane chromatography has the potential to maintain high efficiencies both at high flow-rates and for use of large biomolecules with small diffusivities. In general, as compared to column chromatography, membrane chromatography has several advantages, such as lower pressure drops, higher flow rates, faster binding and higher productivity [72,81]. However, due to the relative smaller surface area the binding capacity in membrane chromatography for proteins is lower than that in conventional chromatography resin.

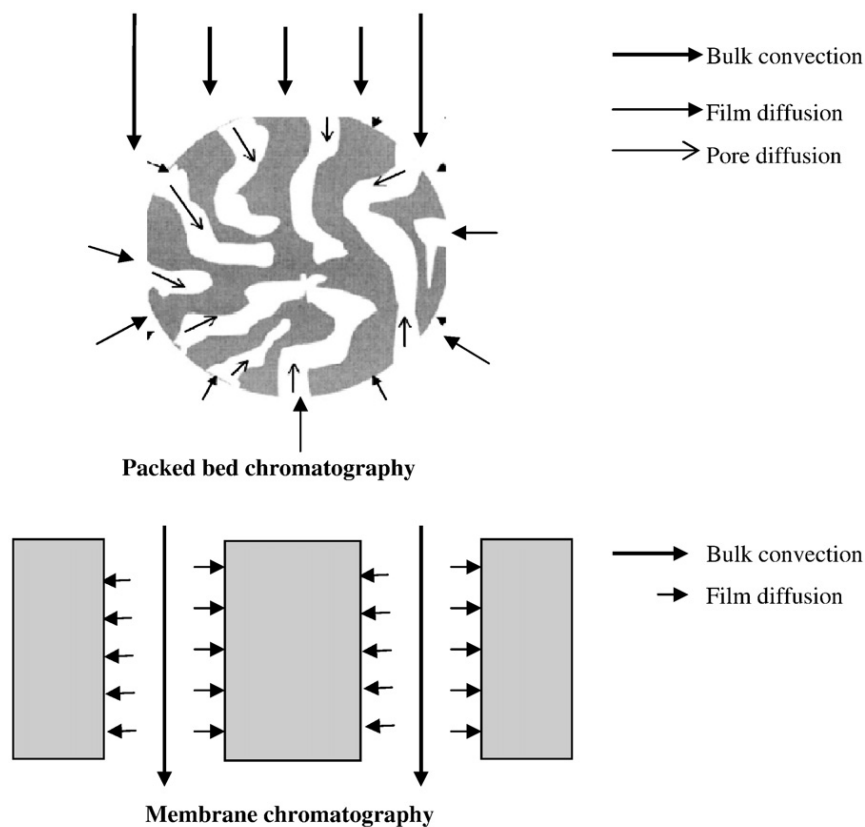

Figure 1.10 Comparison of solute transport between column chromatography and membrane chromatography, taken from Ghosh [74]

Brandt *et al.* [81] published the first paper on membrane chromatography. They proposed a hollow-fiber device for purification of fibronectin from blood plasma and purification of IgG using hollow-fiber membrane-supported proteinA. The high throughput rate and the efficient ligand use of this

device permitted rapid bind–elute cycle times. Because the volume of a typical agarose affinity system was 100–1000 times that of the affinity-membrane device, the membrane device required only about 0.1% as much ligand to handle the same throughput at the same mass transfer efficiency.

Purification of biomolecules using membrane chromatography has been reported in several papers. For example, Ruckenstein and Zeng [82] reported very high selectivities in lysozyme separation from ovalbumin and lysozyme separation from egg white were obtained with lysozyme purity (>98%) and specific activity (>54,000 units/mg) by using macroporous chitin membranes. These results indicate that macroporous chitin membranes are promising and economical matrixes for lysozyme separation at large scale. This macroporous chitin membranes with large pore sizes (average 18 μm) and high adsorption surface were also used to separate wheat germ agglutinin (which is an important and expensive lectin used in medical studies) from a wheat germ extract [83]. In this study, a two-step elution was employed in order to obtain a high-purity wheat germ agglutinin. A purification factor (defined as the ratio between the final and initial specific activities) of 5.5 and an activity yield (defined as the ratio between the total final and initial activities) of 40% were obtained. About 25 mg of pure wheat germ agglutinin was obtained from 50 g of wheat germ.

Purification of other compounds, such as proteins (monoclonal antibody, serum antibody, serum albumin, enzymes, etc.), DNA and viruses have been reported to achieve by using membrane chromatography. Examples of those applications can be summarized as the following:

1. separation of monoclonal antibodies from cell culture media by the use of thiophilic membranes [84]
2. separation of immunoglobulin G from human serum by the use of immobilized L-histidine in hollow-fiber membranes [85]
3. separation of MBP fusion proteins by the use of affinity membranes [86]
4. isolation of antibacterial peptides from lactoferrin by the use of ion-exchange membranes [87]
5. purification of alphaviruses using cation-exchange membranes [88]
6. adsorption of DNA using anion-exchange membranes [89]
7. isolation of influenza A virus from cell culture supernatant using anion-exchange membranes [78]

Particularly, the work of Belanich *et al.* [90] provided an example of a successful application in the pharmaceutical manufacturing which might be quite interesting for Novozymes as they have entered into pharmaceutical business. The scale-up of strong anion-exchange membrane adsorbers removing endotoxin from bacterial extracts while keeping enzyme activity in the protein mixture was demonstrated.

The membrane chromatography technique shows some advantages over column chromatography but it has not obtained the expected success [29]. A possible reason is probably due to the resistance of potential users for this new technology. In addition, membranes for chromatography are attractive for preparative chromatography, as initially developed by Sepracor Inc. to purify large amounts of molecules. In this regard, hollow fibers are particularly well suited, more than flat sheet membrane modules [81]. Finally, membranes for analytical chromatography present less advantage over classical chromatographic supports than those obtained for preparative chromatography.

1.5 Electro-membrane filtration and its application to protein separation

Membrane filtrations in the presence of electric field such as electrically enhanced membrane filtration (MF/UF under electric field) and electrophoretic membrane contactor (electrodialysis with porous membranes MF/UF) will be categorized into electro-membrane filtration and will be discussed in this section. Their applications for the protein separation will be reviewed.

EMF is a separation technique, which superimposes an electrical field to a conventional MF and UF membrane filtrations. In EMF, the electrical field imposes an additional driving force on the charged molecules to TMP. Accordingly, differences in protein electrophoretic coupled to the membrane sieving effect to enhance the selectivity of protein fractionation in EMF. It has been mainly used as an anti-fouling strategy to enhance the permeation flux by reducing concentration polarization and membrane fouling both when using MF and UF membranes [2,91-98]. Basic principle of EMF is presented in Figure 1.11. This process aroused from a combination of a number of mechanisms, including ion association, ion adsorption or ion dissolution. The electrochemical properties of the membrane surface and the dispersed materials or solutes can have a significant influence on the nature and magnitude of the interactions between the membrane and the solutes

being used, and their separation characteristics. The utilization of such properties by the application of external electric fields improved substantially the membrane performance. It has been used to enhance the flux in many systems, flux improvement of a factor 2-10 have been reported during filtration of solutions containing biomolecules or minerals. The flux was improved by 3-7 times when filtration of enzymes with high surface charge at electric field strength of 1600 V/m compared to conventional UF. The greatest improvement was observed at high solution concentration [2]. The solvent flow through the membrane might also be enhanced by the electroosmotic effect; but this effect is considered secondary [1]. Others have investigated the flux enhancement during filtration of mineral suspension [99], BSA solution [92,94,100] and waste water treatment [101]. Furthermore, selectivity enhancement for biomolecules separation (amino acids and peptides) has also been reported using EMF [102-105].

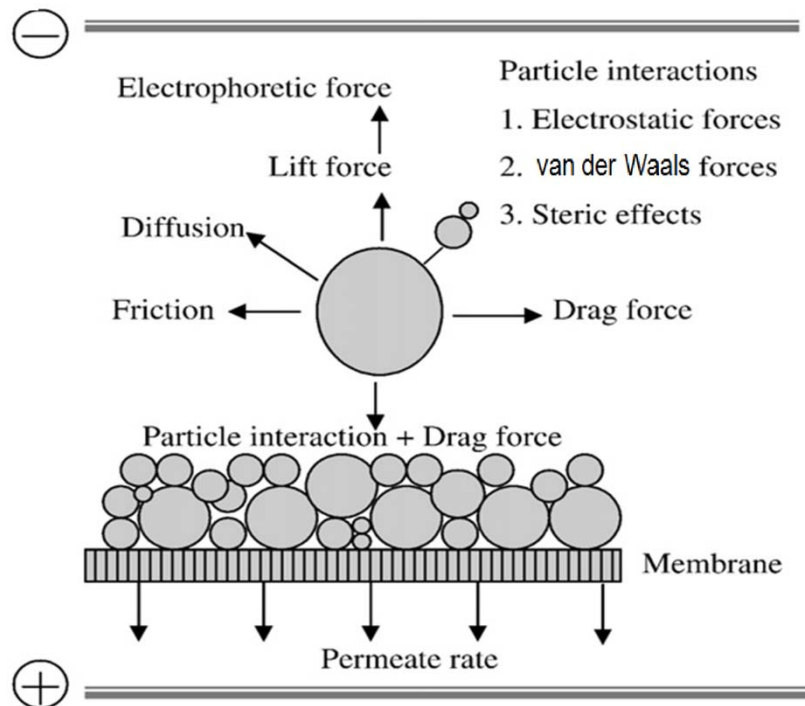

Figure 1.11 Principle of MF/UF in the presence of electric field, modified based on Weigert *et al.*

[95]

However, only few studies reported the effect of EMF on complex protein solutions separation selectivity. Brisson *et al.* investigated the effect of applying an external electrical field during lactoferrin (LF) and whey protein solutions by MF under influence of electrical field strength (0-3333 V/m) and polarity on the permeation flux and protein transmission through a PVDF MF

membrane with 0.5 μm pore size using flat-sheet module [106]. In this case, electrical field had an important impact on protein transmission. Selectivity enhancements were obtained, particularly when the cathode was on the retentate side. In that configuration with electric field strength 3333 V/m, the separation factors obtained between LF and the two main whey proteins β -lactoglobulin and α -lactalbumin were 3.0 and 9.1, respectively. This study demonstrated that the application of an electrical field can modify the transmission of protein dependent on the net charge of protein and the electrical field parameters such as field strength and polarity. Since the electrodes were placed directly in the feed and permeate solutions in this study (as shown in Figure 1.11), electrolytic reactions occurring at the electrodes/solution interface during EMF were observed. There are two major disadvantages with this configuration: alteration of the product pH due to electrolytic reactions and fouling of electrodes due to particles deposition. Furthermore, feed solution containing fragile components can be damaged by direct contact with the electrodes. Protein degradation has been observed when applying an electric field to solutions of BSA, ovalbumin and lactalbumin. Here the membrane was completely blocked by degraded BSA when the concentration was higher than 15 g/L [100]. To avoid degradation of feed components the electrodes must be shielded, e.g. by ion exchange membranes [1,103]

Lentsch *et al.* [107] demonstrated that the combination of an electric field with a pressure driven membrane process (UF membrane) was able to uncouple the transport of different species such as (solute and solvent) or (solutes and solutes). In this work, this combination was successfully applied to separate BSA from PEG 20 kDa which cannot be easily achieved by standard UF. By removing specifically the charged protein from the boundary layer, permeate flux and hence concentration polarization of PEG are enhanced. As a consequence, transmission of PEG was increased and rejection of BSA was kept very high. Thus the separation was achieved and enhanced. The electric field was also successfully applied in the diafiltration mode (electro-diafiltration) of PEG and BSA separation.

Kappler *et al.* used different UF membranes (10kDa and 50 or 100kDa) in a two-sided electro-filter apparatus with flushed electrodes generated significant enhancement of the protein fractionation. The filtration velocity was kept on a very high level for a long time because of electrophoretic effects, selectivity of a binary separation process for BSA and lysozyme could be greatly increased in the current case up to a value of more than 800. Thus, the new two-sided electro-UF technique showed the potential to achieve both high product purity and short separation times [108].

The electrophoretic membrane contactor constitutes of porous membranes and ion-exchange membranes provided another way of EMF operation for protein separation. This separation technique is an electrically driven operation based on the theory of electrophoresis. In this process, no TMP is applied. Therefore, the biggest disadvantage of this technique is that the productivity is rather low due to the lack of convective transport. On the other hand the lack of convective transport is an advantage because membrane fouling will not be severe. It is normally used for purifying high-value proteins or peptides. The use of the porous membranes (MF/UF) in the place of ion-exchange membranes was investigated to extend the field of electro dialysis application for biomolecules separation. In that case, the porous membrane acts as a contactor and the separation is achieved with respect to the difference between the mass flow rates of the solutes. According to the membrane and solute properties, this difference may originate from difference of electrophoretic mobility, sieving effects or a combination of both.

The principle of electrophoretic membrane contactor is illustrated in Figure 1.12. The separation chamber is composed of two compartments separated by a porous membrane (MF or UF membranes), acting as a contactor between the two streams in which the mass transfer takes place. The only driving force is an electric field, which is applied perpendicular to the feed flow. Two electrodes are located in compartments, which are separated from the separation chamber by two ion-exchange membranes. When an electric field is applied, the charged components in the feed solution will migrate from one compartment toward the other through the porous membrane. The mass flow of solute depends on the electrophoretic mobility, which is related to the pH and ionic strength of the buffered solution. Then, solutes having distinct electrophoretic mobilities were transported through the membrane at different rates. Two outlet streams with different compositions are thus obtained. The compartments in which the outlet concentration of the target solute are respectively lower and higher than the inlet, called “dilute” and “concentrate” respectively. The process can be operated in two different ways. Firstly the same solution, containing the species to be separated, can be fed into both compartments. This set-up is called the “separation configuration”. Secondly, the solution is fed into only one compartment, the other compartment, the elution one, being fed with the buffer. This is referred to the “elution configuration” [109].

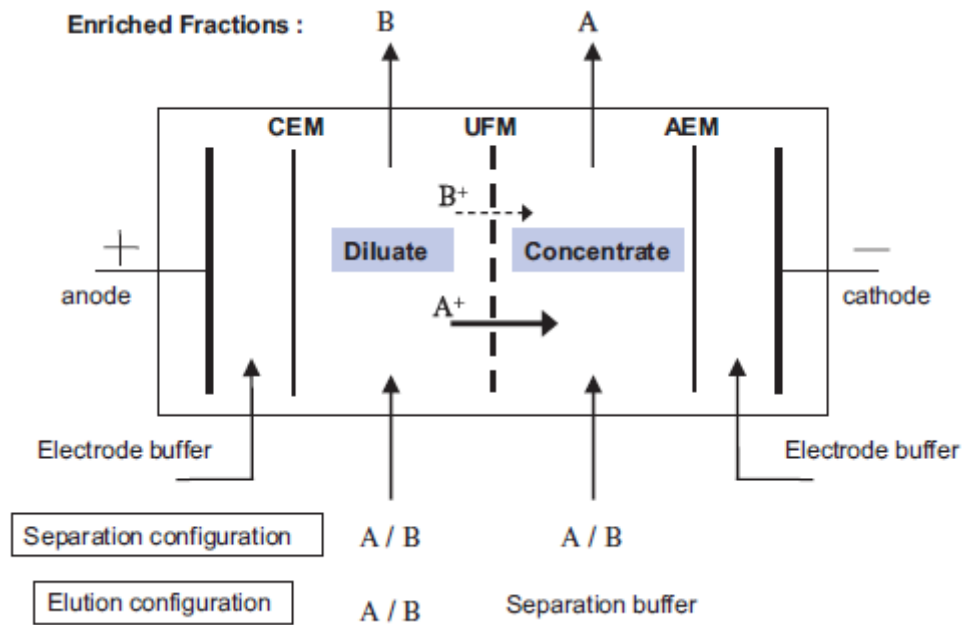

Figure 1.12 Principle of the electrophoretic membrane contactor. UFM: UF membrane; AEM: anion exchange membrane; CEM: cation exchange membrane, taken from Galier and Balmann [109]

Galier and Balmann [109] also summarized different scenarios of separation based on whether separation is due to difference between electrophoretic mobilities (charge-based mode) or to a size exclusion effect, due to the respective pore size of the porous membrane and molecular weight of the solutes (size-based mode) or to a combination of both (charge and size-based mode). Consequently, different situations are possible dependent on the choice of the buffer pH, which determines the electrophoretic mobilities of the proteins, and the membrane MWCO (Table 1.2)

Table 1.2 Different cases of separation in electrophoretic membrane contactor, taken from Galier and Balmann [109]

$u_{mi A} \times u_{mi B}$	Size and charge	Separation Transferred species	Membrane MWCO and pH
$u_{mi A} \times u_{mi B} < 0$ Case 1	Opposite sign	<i>Charge based-mode</i> A and B	$MWCO \gg MW_A$ and MW_B
$u_{mi A} \times u_{mi B} > 0$ Case 2	Same sign $MW_A < MW_B$ and $u_{mi A} > u_{mi B}$	<i>Charge and size based-mode</i> A	$MWCO \gg MW_A$ $MWCO \approx MW_B$ $pH \approx pI_B$
Case 3		<i>Size based-mode</i> A	
Case 4	$MW_A < MW_B$ and $u_{mi A} < u_{mi B}$	<i>Charge based-mode</i> B	$MWCO \gg MW_A$ and MW_B $pH \approx pI_A$

There are several examples of protein separation using electrophoretic membrane contactor which are done by Galier research group [109-112] and Bazinet research group [113]. For example, Galier et al. studied the purification of α -lactalbumin from a mixed solution containing α -lactalbumin and bovine hemoglobin using electrophoretic membrane contactor [112]. Three parameters were chosen to characterize the process performances, i.e. the productivity, purity and the product yield. It was confirmed that the productivity could be enhanced, by a factor of 5 by increasing the inlet concentration. It was further demonstrated that the increase of productivity was achieved without reducing the purity and the product yield. Later on, Galier *et al.* [109] applied a mass-transfer-based methodology to the separation of whey proteins to understand the influence of the pH, the membrane MWCO as well as the role of the electrostatic interactions on the separation efficiency.

1.6 Conclusions

Enzymes are utilized for a wide variety of applied purposes. The advent of recombinant DNA technology has facilitated the production of enzymes and other proteins in a wide range of recombinant species. This review first covers the basic knowledge about enzymes and the main unit operations generally used in industrial enzyme production. The level of downstream processing to which any enzyme is subjected is dependent on the intended application of the product. For economic reasons the level of purification attained is kept to the minimum which will still allow the final product to carry out its intended function efficiently. Bulk industrial scale enzymes are subject

to little purification whereas therapeutic enzymes destined for administration by injection must be highly pure.

The review then also covers the application of membrane technology in enzyme production. A comprehensive review of membrane technology in the application of protein separation was also held. Membranes have been traditionally used to separate species of different size such as proteins from cells, fermentation broths, cell debris and separation of low molecular weight components from proteins. It has been an integral part of biotechnology processes for long time; the well known examples are MF and UF, which have become routine methods for protein separation/fractionation. The development of membrane chromatography, electro-membrane filtration and electrophoretic membrane contactor enable for the complete purification/separation of proteins using membrane systems. Although not implemented in any commercial processes, small-scale studies using this process show comparable yield, purification, and product quality with a conventional process. Deep understanding of physical and chemical phenomena across the membrane interfaces under the operating conditions will help to improve their performance in the biotechnology based industries. Future trends of membranes in protein separation will be driven by higher selectivity, lower cost of production, and enhanced membrane throughput.

Chapter 2

Experimental and theoretical

This chapter presents the general information about the experimental set-up, analytical methods used for concentration determination and theoretical description of EMF. The physical–chemical properties of amino acids, BSA and enzymes are also presented.

2.1 Materials

The amino acids used in this study are L-Leucine ($\geq 99.5\%$ (NT)), L-Lysine($\geq 97\%$) and L-Glutamic acid($\geq 99.5\%$ (NT)) which were obtained from Sigma-Aldrich and were stored in the fridge when not used. The main physical-chemical properties of each amino acid under study are presented in Table 2.1

Table 2.1 Physical-chemical properties of amino acids used in the study

Amino acid	MW (Da)	pI	pKa Values		
			α -COOH	α -NH ₃	Side chain
L-Leucine	131.17	6.01	2.33	9.74	/
L-Lysine	146.19	9.60	2.16	9.06	10.54
L-Glutamic acid	147.13	3.15	2.10	9.47	4.07

BSA in the form of lyophilized powder (purity $\geq 96\%$) was purchased from Sigma -Aldrich, and it was stored in the fridge when not used. BSA has molecular weight (MW) around 66KDa and has pI at around 4.7 (confirmed by the IEF experiment).

The enzymes used in the study of enzyme separation are lipase and phospholipase produced from *Asperigillus oryzae* by Novozymes. The enzyme solutions were taken directly from the production

line after UF concentration. Therefore, the enzymes were not completely pure but contained impurities, which were produced during fermentation or added during the recovery process. The impurities can be carbonates, remaining amino acids, flocculation chemicals and other contaminating proteins formed during fermentation. The most common flocculation chemical CaCl_2 was present in all enzyme solution in large quantities. Other flocculation chemicals such as large anionic or cationic polymers were also possible to be present in the recovery process. Therefore the enzyme solution should be diafiltrated with deionized water in order to reduce the conductivity and concentrate the enzyme solution. All the solutions after diafiltration were then stored frozen and thawed with water bath before use. 2 batches of phospholipase were used and the batch was stated in each experiment. Details of the physical-chemical properties of the enzyme stock solution are listed in Table 2.2.

Table 2.2 Physical-chemical properties of enzyme stock solution used in the study

Enzyme	MW (kDa)	pI(theoretical)	Batch No.	pH	Conductivity (ms/cm)	Concentration (g/L)	Main application
Lipase (Lipolase TM)	29.3	4.7	/	7.5±0.3	4.9	130±5	Detergent industry
Phospholipase (YieldMAX TM)	13.3	7.68	Batch A	5.5±0.3	1.2	25±5	Dairy industry
			Batch B	7.5±0.3	0.6	65±5	

The membranes used in this studied are listed as following:

1. 10kDa surface-modified PVDF UF membrane (commercial name ETNA 10PP from Alfa Laval) .This membrane is claimed to have anti-fouling properties.
2. Polysulfone (PS) based microfiltration membrane (commercial name GRM 0.2pp purchased from Alfa Laval) pore size of 0.2um.This GRM 0.2PP PS membrane was reported to have low surface porosities (12%) and high bulk porosity [114]. PS membranes usually are more hydrophobic as compared to cellulose based membranes. The structure of polysulfone unit is shown in the following Figure

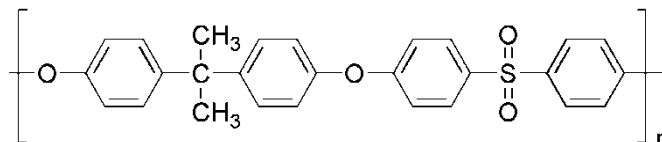

Figure 2.1 Structure of polysulfone unit

3. Cellulose based microfiltration membrane (commercial name Hydrosart membrane purchased from Sartorius) with pore size of 0.2 μ m. The Hydrosart membrane is cross-linked cellulose based membrane that is stable in a broad pH (pH 2-14). The nominated pore size is 0.2 μ m and the porosity is higher than the PS membrane. The membrane is naturally hydrophilic in nature hence it exhibits extremely low non-specific protein binding and virtually non-fouling characteristics due to high amounts of covalent -OH groups. The following Figure shows the structure of cellulose.

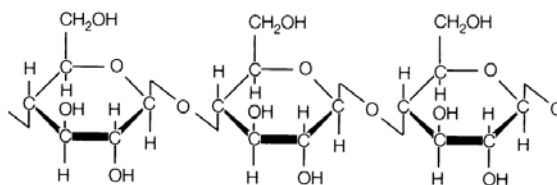

Figure 2.2 Structure of cellulose unit

4. Cation exchange membrane purchased from Mega in Czech Republic (commercial name RELAX-CMH)

More details of the materials are described in each section of the results part.

2.2 Analyses

2.2.1 Analytical methods

- The concentration determination of L-lysine, L-glutamic acid and L-leucine was done by HPLC (DIONEX, UltiMate 3000). Running condition is listed below:

Column: Acclaim OA, 5 μ m; Dimensions: 4 x 150 mm

Mobile Phase: 40 mM Na₂SO₄, pH 2.60 (adjusted with methanesulfonic acid)

Temperature: 30 °C; Flow Rate: 0.6 mL/min; Injection Volume: 20 μ L

Detection: UV, 210 nm

- The concentration of the BSA solution was analyzed by UV Spectrophotometer (PERKIN-ELMER 320) with quartz cuvette at wavelength 280nm.
- The enzyme lipase and phospholipase produced from Novozymes was analyzed by its in house analytical methods called lipase LU assay and phospholipase Leu assay respectively. The lipase concentration (g/L) was calculated from the measured lipase activity (LU/ml) and specific activity of lipase (LU/g) which was equal to 5900LU/g. Likewise, the phospholipase concentration (g/L) was calculated from the measured phospholipase activity (Leu/ml) and specific activity of phospholipase (Leu(P)/g) which was equal to 1400Leu/g. For confidential issue, the details of analytical methods are not able to be presented.

The set-up has a 0.3L permeate reservoir (details in experimental set-up), most of the filtration experiments were performed with circulating the permeate solution. When the experiments were operated with this manner (normally 300ml 0.05M Na₂SO₄ was used as initial permeate solution) the sample was taken via an over flow in the permeate tank during certain time period. The volume of the permeate solution in the permeate reservoir was always kept 300ml after collecting sample. Then the collected sample was then measured respective methods, which was called C_p measured. At the start C_p measured was zero. Based on the mass balance, the real C_p can be calculated as:

$$C_{p \text{ calculated}} = \frac{C_{p T2} * (V_{\text{start}} + \Delta V) - C_{p T1} * V_{\text{start}}}{\Delta V} \quad (1)$$

Where $C_{p T1}$ and $C_{p T2}$ is the measured permeate concentration from the permeate compartment at time T1 and T2, ΔV is the increase of permeate volume from time T1 to T2. V_{start} is always 300ml.

When the experiments were operated with conventional operation manner (no circulation of permeate solution in the permeate tank), where the permeate solution was directly collected from the permeate tube. The measured concentration is considered as permeate concentration C_p which is used to calculate the transmission or rejection.

2.2.2 Separation performance evaluation

The observed rejection of solute by the membrane is defined as Eq.(2)

$$r_{obs}(\%) = \left(1 - \frac{C_p}{C_f}\right) \times 100 \quad (2)$$

Where C_f is the solute concentration of the feed solution and C_p is the solute concentration of the permeate solution (if operated with circulating permeate C_p should be calculated based on mass balance as equation 1 presents). The observed transmission, which describes the ability of solute to pass through the membrane, can be calculated as Eq.(3):

$$T_r = \frac{C_p}{C_f} \quad (3)$$

The separation factor between the two solutes (selectivity) by the membrane can be calculated by the ratio of their transmissions as Eq.(4):

$$S_{a/b} = \frac{T_{r_a}}{T_{r_b}} \quad (4)$$

The purity or the fraction of one solute in the permeate stream can also give an indication of the separation performance. T_{r_a} represents the transmission of solute supposed to be removed from feed and T_{r_b} represents the transmission of solute supposed to be retained in feed. The separation performance is also evaluated by the fraction of one solute in permeate which is defined as Eq.(5):

$$f_a = \frac{C_{p(a)}}{C_{p(a)} + C_{p(b)}} \quad (5)$$

Where $C_{p(a)}$ represents the permeate concentration of solute supposed to be removed from feed and $C_{p(b)}$ the permeate concentration of solute supposed to be retained in feed.

2.3 Theoretical aspects

Electro-membrane filtration (EMF) is a pressure-driven membrane process in which an additional electrical current is applied simultaneously during filtration. The principle of EMF is illustrated schematically by comparing the solute and ions transport at the beginning and at the end of experiment in Figure2.1a and Figure2.1b respectively. Besides the porous membrane, cation-exchange (CEX) membranes are used to prevent degradation of the feedstock and the permeate by preventing direct contact with the electrodes. EMF therefore resembles electrodialysis (ED). The

main difference is the use of a porous membrane (MF or UF membrane in this study) to allow the transport based on size difference of solute. Therefore unlike ED process, EMF combines both pressure-driven and electric-driven membrane filtration. Electrophoresis and electroosmosis, the two important electrokinetic phenomena, exist in EMF. Electrophoresis is the movement of charged molecular under the influence of an electrical field, whereas electroosmosis uses counterions of the membrane under the influence of an electrical field to draw liquid through a membrane. In the presence of electric field, the charged forms of solutes will move to their respective electrodes, while the uncharged solutes will move only when convective transport due to TMP and diffusive transport due to the concentration difference take place.

Apart from the desired transport of solute, salt ions present in feed, permeate and electrolyte solution are also transported as a consequence of applied electric field. As in ED, limiting-current effects may occur, when the transport rate of ions toward the CEX membrane by diffusion is lower than the required electrophoretic transport of ions through the membrane. Thus depletion of ions in the film layer of the membranes may occur which would lead to an increase of the electrical resistance of this layer. When this situation arises, water splitting will occur to maintain the current. Both water splitting and depletion of ions in the film layer will reduce the energy efficiency of the process. Furthermore, water splitting may result in strong changes of the pH of the electrolyte solutions, the feed and especially the permeate. Factors influencing the occurrence of limiting-current situations are well explained elsewhere [115]. More details about EMF can be referred to section 1.6.

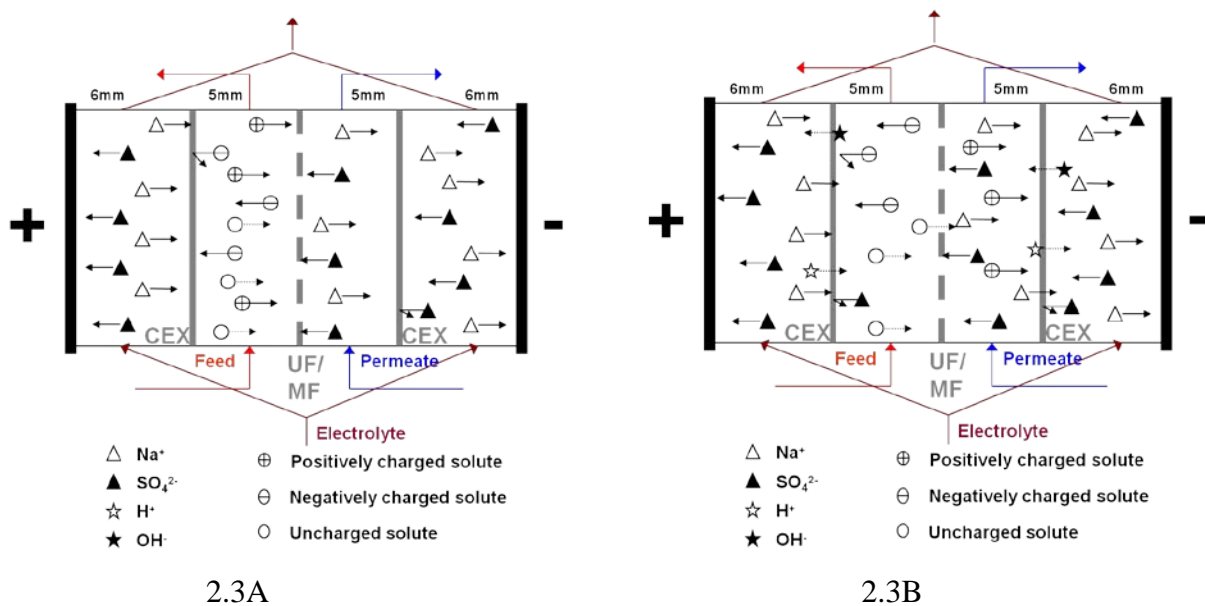

Figure 2.3 The comparison of schematic representation of the solute and ions transport (A) at the beginning and (B) end of EMF, modified by Bargeman *et al.* [102]

In electrolytic solution in the presence of electric field, the mass transport rate of ionic components (in our case, the charged solute of interest such as amino acid, BSA and enzymes) is not only governed by the transport of these components by convection and diffusion as described by Fick's first law of diffusion. The presence of an electric field constitutes an additional mass transfer mechanism known as electrotransport. The transport of components through the porous membrane (MF or UF in our study) in EMF can be described by the Extended Nernst-Planck (ENP) equation, which is very suitable to identify the parameters that may influence the transport rate and the separation selectivity in a quick manner. The transport equation for species i can be written as Eq.(6):

$$J_i = \kappa_i v c_i - D_i \frac{\partial c_i}{\partial x} + F z_i c_i u_i E_f \quad (6)$$

The three terms represent transports due to convection ($\kappa_i v c_i$), diffusion ($-D_i \frac{\partial c_i}{\partial x}$) and electrical field ($F z_i c_i u_i E_f$) gradient respectively. Convection transport is due to the motion of fluid caused by TMP, diffusion transport due to the concentration difference between feed and permeate and electrotransport due to the potential gradient. From the equation, for example we can see that the separation selectivity for the separation of charged solutes can be maximized when the transport rate of the charged solutes is maximized relative to the transport rate of uncharged solutes. This can be achieved by minimizing the convective and diffusive transport while maximizing the electric transport. On the basis of Eq. (6), a high selectivity can therefore be achieved by maximizing the electrical field strength E and the electrophoretic mobility u and minimizing the TMP over the porous membrane. Therefore, Eq. (6) can be used to analyze the parameters influencing the separation selectivity in different situation.

Here $\kappa_i v$ is the solution velocity (κ_i is convective coupling coefficient) which tells the motion of the fluid, c_i is the concentration of component i , D_i its solution diffusivity, z_i its charge, u_i its ionic mobility and $\frac{\partial c_i}{\partial x}$ its concentration gradient, F is Faraday's constant and E_f the electric field

strength in feed compartment defined as voltage U in feed compartment per distance (channel height of feed compartment):

$$E_f = \frac{U_f}{h_f} \quad (7)$$

Since our module consists of four chambers with different conductivities, it is not possible to measure the voltage in feed compartment directly. Therefore, we have to consider the module as a series of resistance, where the applied voltage U_{tot} is a sum of the electrical potential over the four chambers:

$$\begin{aligned} U_{tot} &= U_e + U_f + U_p + U_{others} \\ &= (R_e + R_f + R_p + R_{others})I \end{aligned} \quad (8)$$

Where I is the current, R_e is the resistance of electrolyte compartments, R_f is the resistance of feed compartment, R_p the resistance of permeate compartment and R_{others} the resistance of the other items including two cation-exchange membranes, electrodes etc.

The resistance of each chamber R_x can be replaced by:

$$R_x = \frac{h_x}{K_x A} \quad (9)$$

Where A is the electrode area (equal to the membrane area) and K_x is the conductivity in the specific chamber. The electric field strength across the feed compartment can therefore be calculated by Eq. (10):

$$E_f = \frac{I}{K_f A} \quad (10)$$

The values of I and K_f can be measured and recorded during the experiment. It is not possible to measure U_f directly due to the configuration of the module.

The ionic mobility u_i represents the average velocity of components i in the fluid when a force of 1N/mole was acted on. An uncharged component has a mobility of zero. The electrophoretic

mobility of component i due to the force from electric field can be calculated by multiplying with $F.u_i$:

$$m_i = z_i.F.u_i \quad (11)$$

Since the ionic mobility is positive for all components, the electrophoretic mobility is positive for positive ions and negative for negative ions. Therefore, the extended Nernst-Planck equation of each component requires two transport properties, its diffusivity D_i and its ionic mobility u_i . In dilute solution, the diffusivity of component i is related to its ionic mobility by the Nernst-Einstein relation[116].

$$D_i = u_i.R.T \quad (12)$$

Each ion moves with its own specific velocity in the presence of electric field. This specific velocity v_e depends on the electric field strength E_f and electrophoretic mobility m_i [117]:

$$v_{e,i} = m_i.E_f \quad (13)$$

It can be seen that the velocity is proportional to the electric field strength. Due to the fact that each component moves with its own velocity, at constant electric field strength, different components can be separated based on their difference in electrophoretic mobility.

Electrophoretic mobility is a function of the viscosity and the dielectric constant of solution in which the ion is present. The solution viscosity and dielectric constant are related with the temperature of the solution, therefore the electrophoretic mobility is also a function of temperature. It also depends on the charge, size and shape of the component. With the ionic strength increasing, the electrophoretic mobility decreases according to zeta-potential change. Therefore, the electrophoretic mobility is also related with the electrolyte concentration. It is important to have a low salt concentration in the solution in order to achieve a high zeta-potential, therefore a bigger electrophoretic mobility and thereby a high effect of the electric field on the component. However, the electrophoretic mobility is also related to the diffusivity of the component. At low ionic strength of the feed solution, the diffusivity of charged component is reduced due to a lack of counter-ions. Therefore, the ionic strength of the feed solution should be at an optimal value in order to have both high effect of the electric field and high diffusivity of the charged component.

2.4 Experimental set-up

A schematic presentation of the EMF set-up used in this study is presented in Figure 2.4. The module consists of four compartments with one porous membrane (MF or UF membrane) flanked by two cation exchange membranes (RELAX-CMH from Mega) which are used to prevent degradation of the feed and the permeate solution by preventing direct contact with the electrodes. The volume of the feed compartment (F), permeate compartment (P) and two electrolyte compartments (E) (including supply tank and piping volume) are 2.5L, 0.3L and 1L, respectively. The channel height of the electrolyte, feed and permeate compartments are 6, 5 and 5mm, respectively. The membrane area is $10 \times 10 \text{ cm}^2$. The set-up was operated in a batch-wise manner. Both retentate and electrolyte were recirculated back to the feed and electrolyte tank, apart from sampling for analysis. The permeate stream was kept at a constant volume by an overflow pipe in the permeate tank, in which the excess amount of permeate was taken during a certain time for flux measurement and sampled for analysis. Recycling of the permeate stream was carried out in order to keep a relatively high salt concentration, and thereby reduces problems related to a limiting current effect. In order to equalize the pH change in the anolyte and catholyte, the two streams were mixed. The anode was made of plantinized titanium and the cathode was made of stainless steel. The electric field was generated by a power supply from Xantrex (XHR 150-7). The TMP can be set by adjusting a valve placed on the retentate side. More details about the set-up have been described elsewhere [1,2]

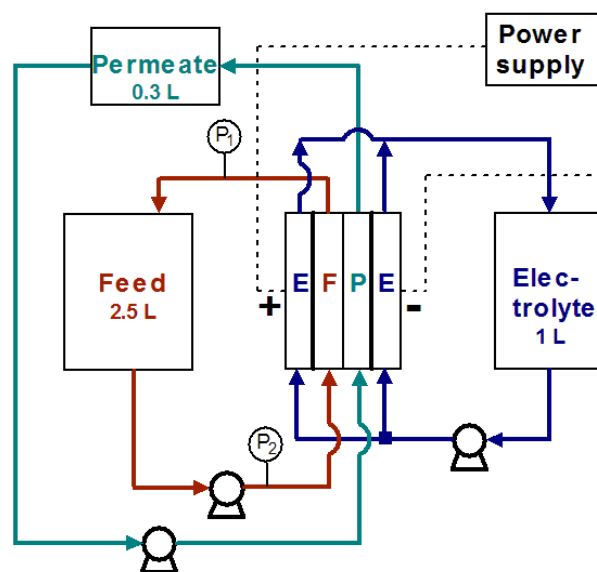

Figure 2.4 Experimental batch-wise EMF set-up in the study. Feed/retentate, permeate and electrolyte solutions were recycled in the feed (F), permeate (P) and electrolyte (E) compartments, respectively, modified based on Enevoldsen [2,118].

After each experiment the membrane system was cleaned by the following procedure:

- Rinsing with 6 times volume of the system with deionized water
- Cleaning with 10mM NaOH at 50 degree for 30min with circulation in feed, permeate and electrolyte compartment
- Rinsing with 6 times volume of the system with deionized water

The water permeability was checked before the start of each experiment to ensure that the membrane is cleaned properly. The statement will be made when the procedure is changed in a specific situation.

Flux reduction $F_{reduction}$ defined in Eq.(14) is used as to characterize fouling tendency of the membrane in each experiment. The higher $F_{reduction}$ is, the more severe membrane fouling is.

$$F_{reduction} = \frac{J_{w.start} - J_{w.end}}{J_{w.start}} \quad (14)$$

$J_{w.start}$ is the water permeability before the experiment; $J_{w.end}$ is the water permeability after experiment.

All the experiments were operated in full recycle mode by returning the retentate back to the feed tank. The permeate volume flux was measured manually as the mass of permeate from an overflow pipe from the permeate tank during a certain time interval. The permeate volume flux can be calculated according to Eq.(15):

$$J_w = \frac{1}{A} \frac{\Delta m}{\Delta t} \frac{1}{\rho} \quad (15)$$

Where A is the effective membrane area ($1 \times 10^{-2} m^2$), and $\Delta m / \Delta t$ (g/h) is the mass of permeate collected within time Δt ; the permeate density was considered as 1 kg/m^3 .

Then samples of the permeate solution and the feed solution were checked with conductivity, concentration and pH respectively. The recirculation flow rates of permeate and electrolyte solution

were at a rate of 22L/h and 60L/h respectively (flow rate of electrolyte solution in enzyme part was 70L/h). The crossflow velocity was 1.25×10^{-2} m/s. The detailed experimental procedure will be described in each section of the result part.

Chapter 3

Electro-ultrafiltration of amino acids

In this chapter, amino acids were used as model solution to test the feasibility of EMF in the application of amphoteric molecules separation. In section 3.3.1, NaCl was used to investigate how this system can be operated in ions transport through porous membrane with regard to parameters such as current density, polarity and TMP. In section 3.3.2, single amino acid was used to illustrate the effect of electric field on the transport of charged amino acid. In section 3.3.3, separation between Glu and Leu in UF filtration with and without electric field was investigated. In section 3.3.4, demonstration of diafiltration in the presence of electric field was investigated.

3.1 Introduction

Large-scale economic purification of enzymes is of increasingly important for the biotechnology industry. Separation of a desired enzyme from other enzymes produced by the cell is usually attempted using a combination of different chromatography techniques. Adequate purity is often not achieved unless several purification steps are combined thereby increasing cost and reducing product yield. Consequently there is a need for processes that purify enzyme mixtures using fewer steps and without the need for a costly affinity step. Membrane processes are widely used in the biochemical industry for separation and concentration of enzyme. Traditionally fractionation of enzymes using membrane due to the variation in size of the enzymes is rather limited, which is partly caused by concentration polarization and membrane fouling. Furthermore, for the isolation of enzymes of similar size, generally membrane filtration has too low selectivity whereas chromatography is expensive.

Enevoldsen *et al.* [1,2] have shown that by using an electric field during crossflow ultrafiltration (EUF) of industrial enzymes solutions, a 3-7 times improvement in flux has been obtained. This indicates that using an overlaid electric field is an effective way to depolarize the membrane surface when operating with enzyme solutions. Likewise, the research groups of Rios and Pupanat showed similar results that a high permeate flux was maintained by introducing the electrical field in

membrane modules to reduce fouling or concentration polarization [97,119]. EMF has also been reported to improve the membrane selectivity in the literature. Lentsch *et al.* [107] investigated the separation of bovine serum albumin (BSA) from polyethylene glycol (PEG) using electrically enhanced ultrafiltration. Separation of BSA from PEG (20 kDa) is found to be almost impossible by standard ultrafiltration because of the concentration polarization of BSA. BSA has about the same size as PEG (both have Stokes radius around 3.5nm) but its charge is highly dependent on pH. At pH 6.8 BSA was negatively charged, hence was repelled from the membrane due to the electric field while PEG was neutral, which was transported towards the membrane due to the convective transport. The transmission of PEG was increased by reducing polarization of BSA. The permeate flux was also enhanced simultaneously to some extent.

Amino acids are amphoteric compounds as like proteins. Furthermore, because of their small molecular sizes as compared to UF membrane, they have hardly any fouling on the membrane, as compared to enzymes, which show complex behavior. Hence, they provide a simpler comparison between experimental and theoretical trends. Conventional pressure-driven processes (ultrafiltration, nanofiltration) have been used for amino acids separation [25,68,120] but are limited by their low selectivity when separating similar sized molecules and their tendency to foul [121]. Tsuru *et al.* [24] used organic NF membrane to fractionate binary solutions of charged (Rejection > 80%) and neutral (Rejection < 5%) amino acids. The high retention of charged solutes has been explained by the Donnan theory. The selectivity of the separation was high, especially when the pH-pI difference was large. Likewise, Kimura *et al.* [122] demonstrated that amino acids with MW from 75 to 200 can be separated by its charge using charged membrane made of sulfonated polysulfone with MW cut-off value about 10kDa. In addition to the expected increase in flux, an improvement of selectivity based on the electric charge of amino acids has been reported [102,123]. Lee and Hong [124] showed two amino acids with opposite charge were successfully separated using in the presence of electric field.

In the chapter, separation of L-Leucine (Leu) from L-Glutamic acid (Glu) by electro-membrane filtration (EMF) with a UF membrane is presented. The scope of this work is to study the effect of an electric field on the transport and separation of charged amino acids with UF membrane. Using amino acids as a model, the ultimate objective of this work is to evaluate the possibility of this process in the application of enzymes fractionation because of the industrial need for alternative

cost-effective separation. The effect of current and trans-membrane pressure on separation was evaluated. Finally, the workability of diafiltration in the presence of electric field was also studied.

3.2 Materials and methods

3.2.1 Charge characteristics of amino acid

Amino acids are amphoteric components, which both have a basic and an acidic group; they can be neutral, positively or negatively charged depending on the pH of the solution.

The pH at which positively charged and negatively charged amino acids are exactly in balance is called the isoelectric point (pI). When solution $\text{pH} > \text{pI}$, the amino acid is negatively charged and migrates towards the anode in the presence of electrical field. When solution $\text{pH} < \text{pI}$, the amino acid is positively charged and migrates towards the cathode. When solution $\text{pH} = \text{pI}$, since positively charged amino acid and negatively charged amino acid are in balance, there is no net charge and the amino acid does not migrate in an electric field.

Using the Henderson-Hasselbalch Eq. (16):

$$\text{pH} = \text{pK}_a + \log \frac{[A^-]}{[HA]}$$

$$\text{pH} = \text{pK}_a + \log \frac{[\text{base}]}{[\text{acid}]} \quad (16)$$

Here pK_a is $-\log(\text{K}_a)$, where K_a is the acid dissociation constant.

Together with using the acidic formulation of ionization by Brønsted–Lowry acid-base theory, the relative fraction of the various forms of an amino acid as a function of pH can be calculated [115]. Figure 3.1, 3.2 and 3.3 show the relative fraction of the amino acids Glu, Leu and Lys, respectively, as function of pH.

These plots help to identify quantitatively what forms of amino acid exist at a given pH value and eventually predict the migration direction through the membranes in the presence of electric field. Similarly, by adjusting the solution pH one can obtain the exact form of amino acid as one wants using these plots.

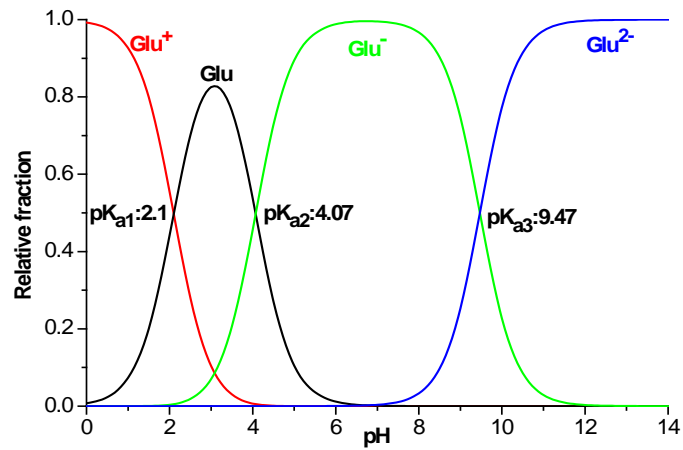

Figure 3.1 Relative fraction of Glu as function of the solution pH

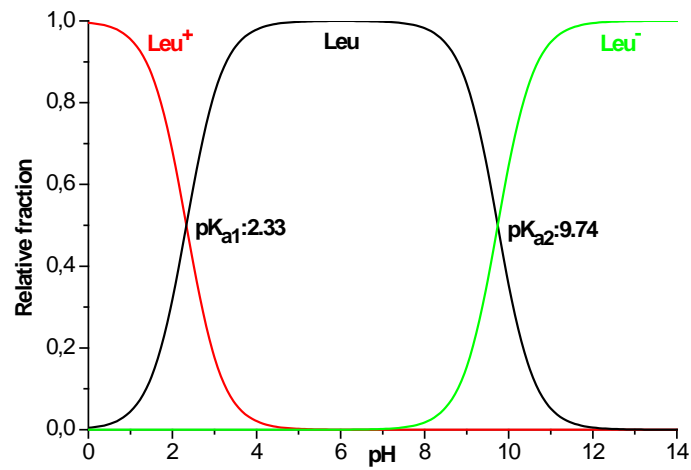

Figure 3.2 Relative fraction of Leu as function of the solution pH

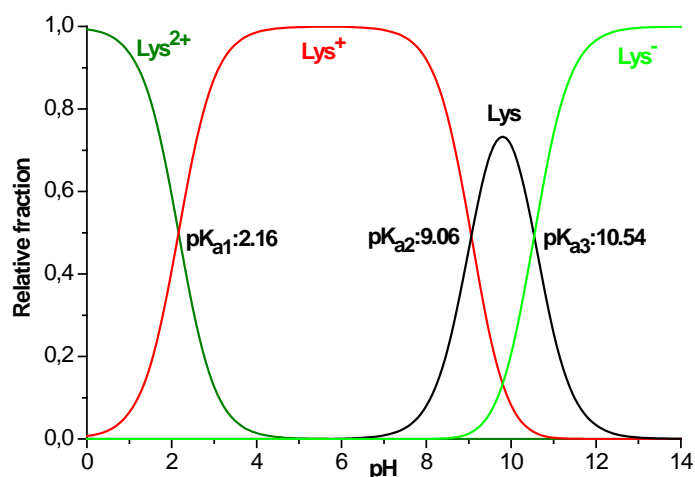

Figure 3.3 Relative fraction of Lys as function of the solution pH

More details can be referred to section 2.1, 2.2 and 2.4.

3.2.2 Experimental procedure

Three series of experiments were carried out in this chapter. The first series of experiments used NaCl to investigate how the system functions with regard to ion transport. Details of those experiments can be found in section 3.3.1. The second series of experiments dealt with EMF of single amino acid where Glu and Lys were used as the feed solution. Before the start of each experiment, the pH of feed solution was adjusted with either 0.1M NaOH or 0.1M HCl to the values where Glu was nearly 100% negatively charged and Lys was nearly 100% positively charged. The titrator started automatically if the pH changes more than 0.5 from the initial values. More details about the experiments can be referred to section 3.3.2. The third series of experiments dealt with separation of Leu from Glu using EMF. Details can be referred to section 3.3.3.

Furthermore, diafiltration in the presence of electric field named electro-diafiltration was carried out in order to evaluate whether an electric field could be applied in the diafiltration mode. The experiment was carried out with the same set-up and connecting with an external separatory funnel to the feed tank. The experiment was started with the same surface level of water in the separatory funnel as in the feed tank, and this level was kept stable during the experiment time. Water was fed

continuously to the feed tank at the same rate as the permeate flux just by controlling the surface level of the separatory funnel. In this way the volume of feed tank would also be stable.

All the experiments were operated in full recycle mode by returning the retentate back to the feed tank. The permeate volume flux was measured manually as the mass of permeate from an overflow pipe from the permeate tank during a certain time interval. The permeate volume flux can be calculated according to Eq.(15) in chapter 2.

The samples of the permeate solution and the feed solution were checked with conductivity, concentration and pH respectively. The recirculation flow rates of permeate and electrolyte solution were 22L/h and 60L/h respectively (recirculation time of permeate and electrolyte solution in the system was 49.1 seconds and 60 seconds respectively). The crossflow velocity was 1.25×10^{-2} m/s. The initial electrolyte consisted of 0.1M Na_2SO_4 with a conductivity around 17ms/cm. The initial permeate solution varied according to different experiments which could be found section 3.3. After each experiment the system was cleaned according to the procedure suggested by Enevoldsen [1]. Then the water permeability was checked to ensure the membrane was cleaned properly.

3.3 Results and discussion

3.3.1 Operation of system using NaCl

The primary objective of using NaCl as the initial model solution is to investigate how this system can be operated in ions transport through porous membrane with regard to parameters such as current density, polarity and TMP. The generated results from this study are expected to be informative for the studies on charged amino acid transport in EMF.

The following Table 3.1 illustrates the experimental conditions of the experiments performed with EMF filtration of NaCl at different polarities. 1g/L NaCl was used both as the initial feed and permeate solution. Experiments were performed to 1) investigate the effect of current density on the NaCl transport at constant TMP both for polarity +UF- (anode on the retentate side) and -UF+ (anode on the permeate side), 2) investigate the effect of TMP on the NaCl transport at constant current density both for polarity +UF- and -UF+ and 3) investigate the effect of polarity on the NaCl transport at constant current density and TMP.

Table 3.1 Summary of experimental conditions for EMF of NaCl (For conciseness in presenting the results, short terms +UF- and -UF+ have been used, +UF-: anode placed next to feed side and cathode next to permeate side with UF in the middle; -UF+: cathode placed next to feed side and anode next to permeate side)

EMF of NaCl Objective of Exp.	Electrode Polarity	Initial feed solution	Initial permeate solution	Current density(A/m ²)	TMP(bar)
Look at effect of current density	+UF-	1g/L NaCl	1g/L NaCl	60;90;120	0.6
Look at effect of current density	-UF+	1g/L NaCl	1g/L NaCl	60;90;120	0.6
Look at effect of TMP	+UF-	1g/L NaCl	1g/L NaCl	60	0.47;0.58;0.97
Look at effect of TMP	-UF+	1g/L NaCl	1g/L NaCl	20	0.38;0.65;1.16

3.3.1.1 Effects of electrode polarity and current density on permeate

conductivity change

The permeate conductivity change can be the results of diffusive, convective and electrical transports between the feed and permeate. Since the concentrations in the permeate and the feed compartment were the same, the diffusive transport at the start of experiments can be ignored. It can also be assumed that the UF membrane has no selective transport to NaCl transport, therefore the convective transport will not cause any conductivity change in permeate. In order to investigate the effect of current density on permeate conductivity change, experiments were performed at constant TMP with the same concentration of NaCl solution in the permeate and the feed compartment. The permeate conductivity measured directly from the bulk solution via overflow in the permeate reservoir as the function of time is plotted in Figure 3.4

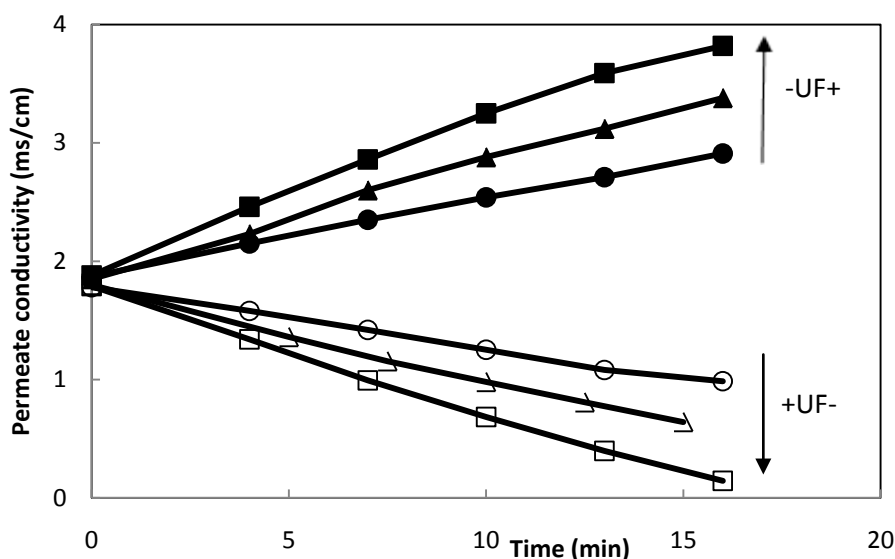

Figure 3.4 Permeate conductivity changes in the permeate reservoir at different current densities, polarities and at constant TMP 0.6bar during EMF of NaCl, (■)120 A/m²(▲) 90 A/m²(●) 60 A/m²(□) 120 A/m² (△) 90 A/m²(○) 60 A/m²

At polarity $-UF+$, the permeate conductivity increase gradually, and the increase rate increased with the increase of current density. While at polarity $+UF-$, the permeate conductivity decrease gradually, and the decrease rate increased with the increase of current density. Under the influence of electric field, the Cl^- ions migrate toward anode and the Na^+ ions migrate toward cathode. However in our cases, due to the fact that the Cl^- ions will not be able to migrate through the cation-exchange membrane, they will be only transported between permeate and feed. In addition, the mobility and diffusivity of Cl^- ion are higher than Na^+ therefore according to ENP equation mass transport rate of Cl^- is higher than Na^+ . Then the electroneutrality condition should be followed. As the results of those factors, at polarity $-UF+$, the permeate conductivity increased and feed conductivity decreased. While at polarity $+UF-$, the permeate conductivity decreased due to depletion of both Na^+ and Cl^- ions and feed conductivity increased.

3.3.1.2 Effect of TMP on permeate conductivity change

The effect of TMP on permeate conductivity change was investigated by performing experiments at constant current density and various TMP both for parity $+UF-$ and $-UF+$. The results are presented in Figure 3.5.

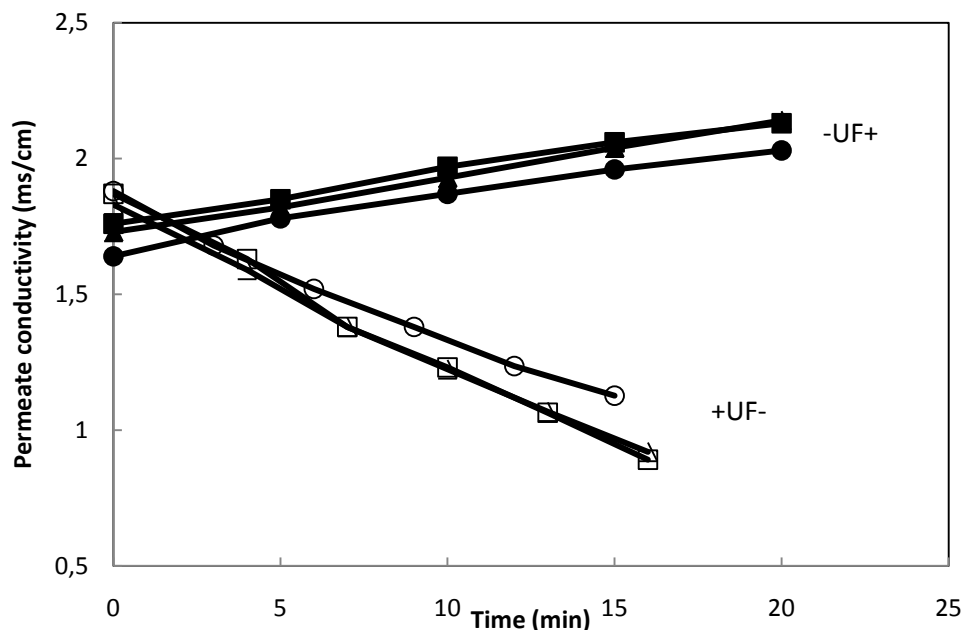

Figure 3.5 Permeate conductivity changes in the permeate reservoir at different TMP, polarities and at constant current density during EMF of NaCl (60A/m^2 and 20A/m^2 at polarity +UF- and -UF+ respectively) (■) 0.65bar (▲) 0.38bar (●) 1.16 bar (□) 0.47bar (△) 0.58bar (○) 0.97bar

As can be seen in Figure 3.5, whether the permeate conductivity increased or decreased was again determined by polarity. TMP has hardly any effect on the change of permeate conductivity. This was due to UF membrane has no selective transport towards NaCl solution.

By looking at the effects of electrode polarity on the NaCl transport in terms of permeate conductivity change, it can be concluded that by carefully choosing the polarity the concentrated and desalted streams can be well forecasted in which compartment. This is useful especially when the product is to be desalted from the feed stream, polarity of -UF+ will be chosen. The energy consumption will increase when TMP is increased; however there is no need to have TMP in the cases of salt removal. Current density is the key parameter to determine the transport rate of salt ions transport in EMF.

3.3.2 EMF of single amino acids

The amino acids Lys and Glu were chosen as the single amino acid model because of their similar MW and distinct pI. At pH 7, Lys is positively charged while Glu negatively charged. The objective of this study is to understand the effect of electrophoretic force on the charged amino acid transport

in comparison with normal pressure-driven filtration. 4 different experiments were conducted at each polarity in. Experimental conditions of the 4 experiments are summarized in Table 3 as shown below.

Table 3.2 Summary of experimental conditions for EMF of single amino acids

EMF of single amino acid Objective	Electrode Polarity	Initial feed solution	Initial permeate solution	Current density(A/m ²)	TMP (bar)
To investigate the effects of electric field and polarity on EMF of positively charged amino acid	+UF-	7.8mM Lys	50mM Na ₂ SO ₄	40	0.28
	-UF+	8.3mM Lys	50mM Na ₂ SO ₄	40	0.28
To investigate the effects of electric field and polarity on EMF of negatively charged amino acid	+UF-	9.3mM Glu	50mM Na ₂ SO ₄	40	0.28
	-UF+	9.4mM Glu	50mM Na ₂ SO ₄	40	0.28

3.3.2.1 Negatively charged Glu

According to Figure 3.1, Glu is negatively charged at the range of pH 6.5-8 which was the case in the experiments. Figure 3.6A and B show the permeate concentration (calculated based on equation 1 in chapter 2) and feed concentration change both with and without applying electric field at 2 different polarities. In the first 45min, both of the experiments were performed with normal UF filtration, therefore the transport of the negatively charged Glu into the permeate compartment was only due to convective transport. The electric field was then applied from 45 min in each experiment.

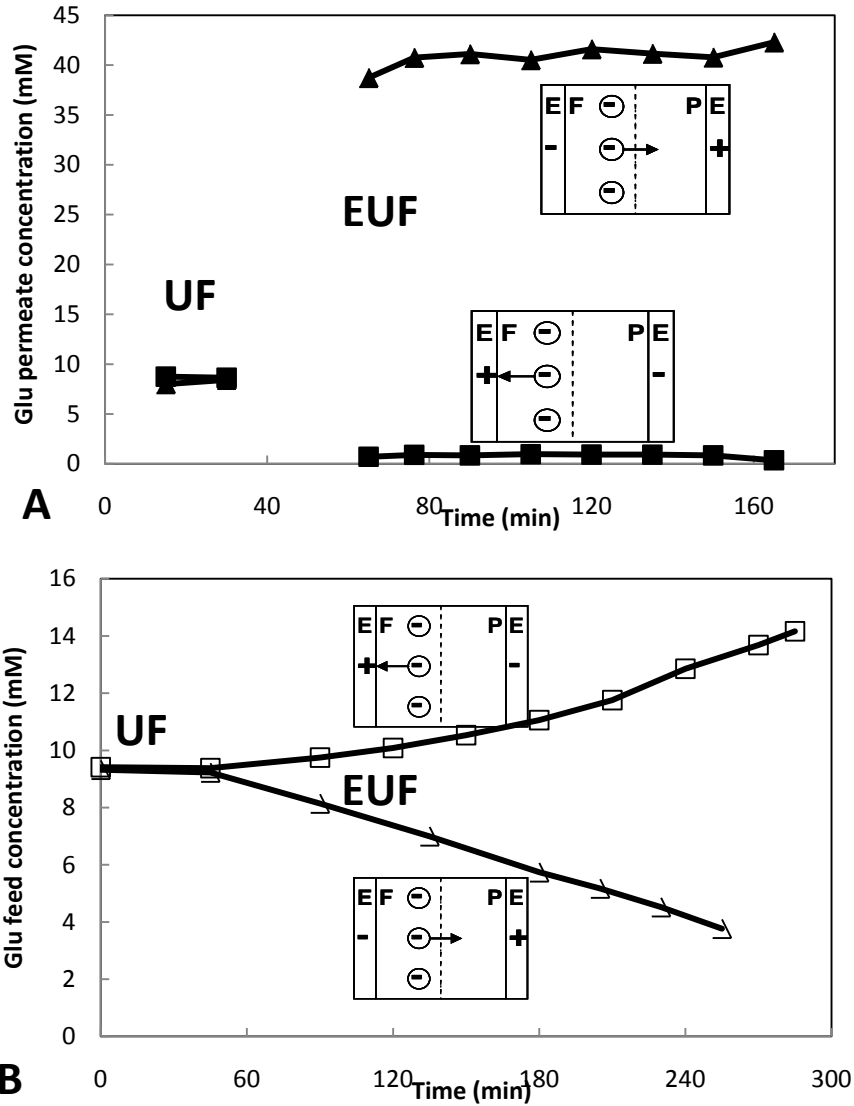

Figure 3.6 (A)Permeate concentration and (B)feed concentration of Glu with and without the application of electric field at different polarity, feed pH at 7 ± 0.5 during EMF of Glu (■) C_p 0.28bar 0/40 A/m² +UF- (▲) C_p 0.28bar 0/40 A/m² -UF+(□) C_f 0.28bar 0/40 A/m² +UF- (△) C_f 0.28bar 0/40 A/m² -UF+

As can be seen both from Figure 3.6(A) and (B), the permeate concentration of Glu was nearly the same with the feed concentration when operated with UF filtration suggesting that Glu can pass through the UF membrane freely. When electric field was applied at polarity -UF+, the permeate concentration of Glu increased dramatically by 4-fold factor. This was due to the additional electrophoretic force in addition to convective transport which enhanced the mass transport. Meanwhile, the feed concentration started decreasing gradually. And when electric field was

applied at polarity +UF-, the changes of permeate and feed concentration displayed the opposite pattern as those in -UF+. We demonstrated that by applying electric field in a right direction, one can either concentrate product in the feed or the permeate compartment.

Figure 3.7 shows the conductivity and pH changes in the permeate compartment.

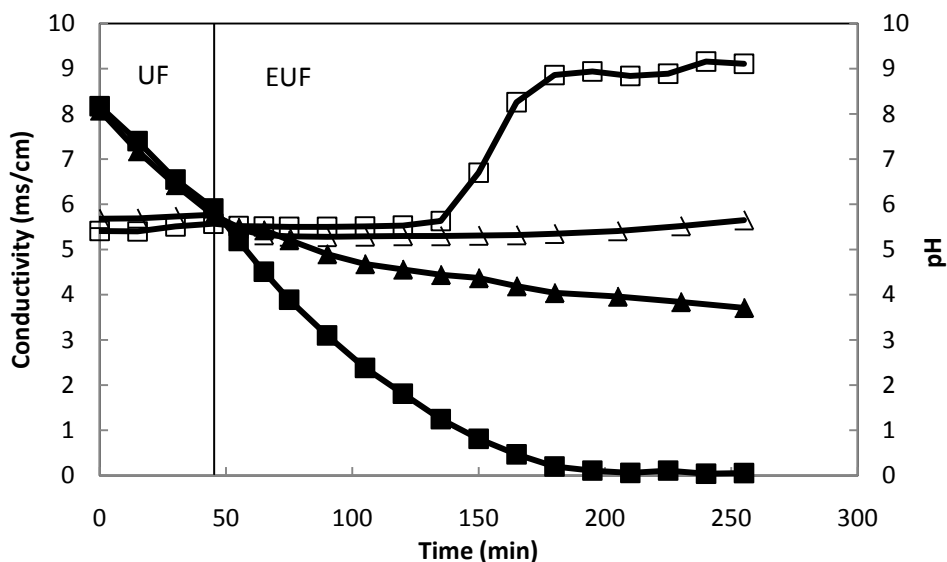

Figure 3.7 Conductivity and pH changes in the permeate compartment both at polarity +UF- and -UF+ during EMF of Glu,(■)Conductivity +UF-(□)pH +UF- (▲)Conductivity -UF+(△)pH -UF+

As can be seen in Figure 3.7, the conductivity in the permeate compartment decreased when operating with UF due to dilution effect. By applying the electric field, the decline rate can either be enhanced or decreased at different polarities. The reason why the permeate conductivity decreased at polarity -UF+ was due to the dilution effect caused by convective transport. Otherwise electric field had exactly the same effect on the permeate conductivity change as Figure 3.3 and 3.4 show i.e. at polarity +UF- it worked as a desalination effect while at polarity -UF+ as a concentration effect in the permeate compartment. Meanwhile, the feed conductivity either increased at polarity +UF- or decreased at polarity -UF+ (data not showed), due to the relative bigger volume of feed tank, the change was not distinct.

Lapointe *et al.* [105] have indicated that in the shortage of permeate conductivity, electrolytic reactions which lead to the production of OH⁻ at the cathode and H⁺ at the anode could take place. This especially could result in the pH change in the permeate compartment due to its relatively

smaller volume than feed compartment. Similar results were also found in the studies, as can be seen in Figure 7, at polarity +UF-, when conductivity decreased to at around 1 ms/cm, permeate pH jumped up from around 6 to higher than 9. The increase of permeate pH proved that production of OH- at cathode in the presence of electric field, which then migrated towards anode. Thanks to the bigger volume of feed tank, the migration of OH- towards anode only caused slight pH increase which could be neglected.

At polarity -UF+, permeate pH stayed quite stable during the whole experiment due to the relative higher permeate conductivity. However, in the feed compartment, the increase of feed pH was slightly more pronounced than that at polarity +UF-, this was due to the lower conductivity in the feed tank in the case of polarity -UF+, which led to electrolytic reactions.

3.3.2.2 Positively charged Lys

We have shown that by applying electric field, transport of negatively charged Glu can be manipulated, depending on the polarity the transport could either be enhanced or weakened. In order to test the robustness of the system, Lys was chosen for the further study.

According to Figure 3.3, Lys is positively charged at the pH range of 7-7.6 which was the case in the experiments. Figure 3.8 shows the Lys concentration measured from permeate reservoir (it is expected that positively charged Lys can migrate to electrolyte compartment, therefore Lys permeate concentration calculated based on mass balance according to equation (1) cannot be precisely used as C_p for transmission or rejection calculation) and electrolyte reservoir both with and without applying electric field at polarity +UF-. As can be seen in Figure 3.8, the permeate concentration of Lys increased when the electric field was applied in comparison with the first 45min where there was only convective transport taking place. However, after 80min the permeate concentration of Lys started decreasing dramatically to 0mM at 160min. The decrease of Lys concentration in permeate from 80min can be due to the transport of Lys in permeate to electrolyte as shown that the Lys concentration in electrolyte increased. The phenomenon is attributed to: first, positively charged Lys can pass through the cation exchange membrane; secondly, after 80min the conductivity of permeate was quite low hence the Lys was transported to carry out the current instead of Na^+ .

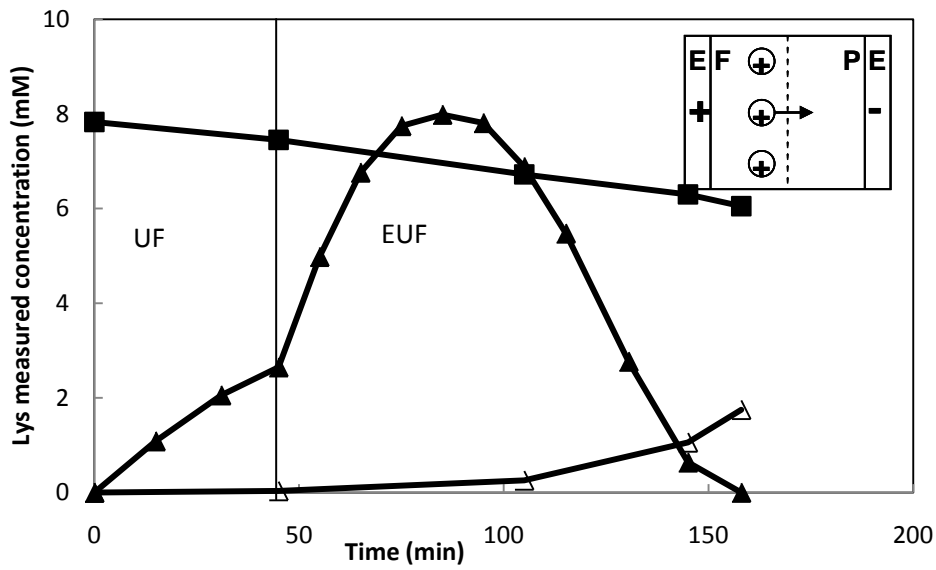

Figure 3.8 Lys concentration changes measured from the permeate and electrolyte compartment with and without the application of electric field at polarity +UF- at constant TMP 0.28 bar, feed pH at 7.2 ± 0.2 (■) feed (▲) permeate(△) electrolyte

Figure 3.9 shows the Lys concentration measured from permeate, feed and electrolyte at polarity – UF+.

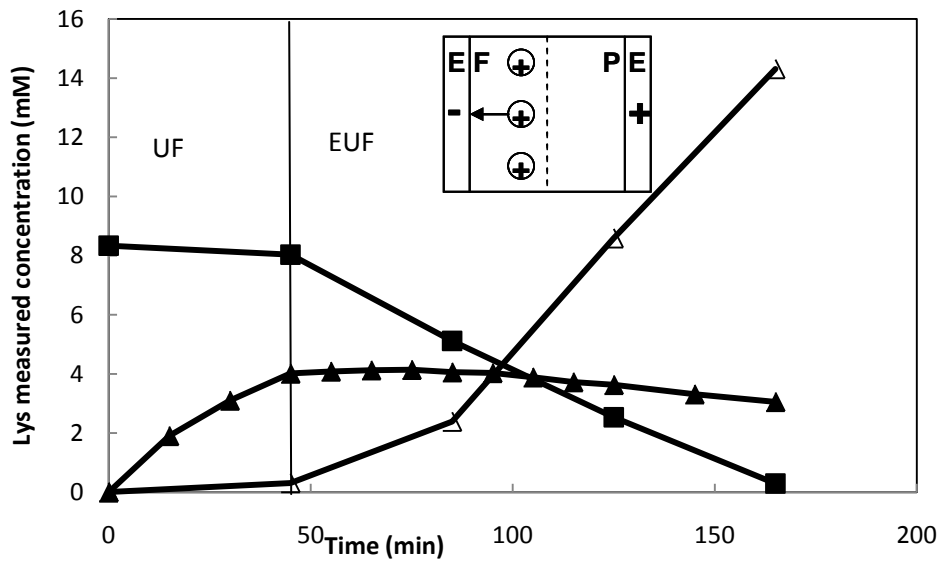

Figure 3.9 Lys concentration changes measured from permeate, feed and electrolyte compartments with and without the application of electric field at polarity –UF+ at constant TMP 0.28bar, feed pH at 7-9.5(■)feed(▲)permeate(△)electrolyte

It is evident that the feed concentration decreased dramatically when electric field was applied from 45 min. Concomitantly, Lys concentration in electrolyte compartment increased rapidly due to the fact that positively charged Lys can pass through cation exchange membrane. Therefore, we can learn that this set-up can only be used for filtration of negatively charged or neutral amino acids. The ion exchange membranes in this set-up shall be well chosen if it is used for filtration of positively charged amino acids.

Both the conductivity and pH in the permeate and feed compartments showed quite similar pattern as in the case of Glu. But there are still some differences e.g. in Figure 3.10 the conductivity in the permeate compartment was quite stable and a slight increase was observed when applying electric field at polarity $-UF+$, this phenomenon might be due to the fact that in this case, Cl^- from the titration solution has higher mobility and conductivity than Glu^- which could just overcome the dilution effect.

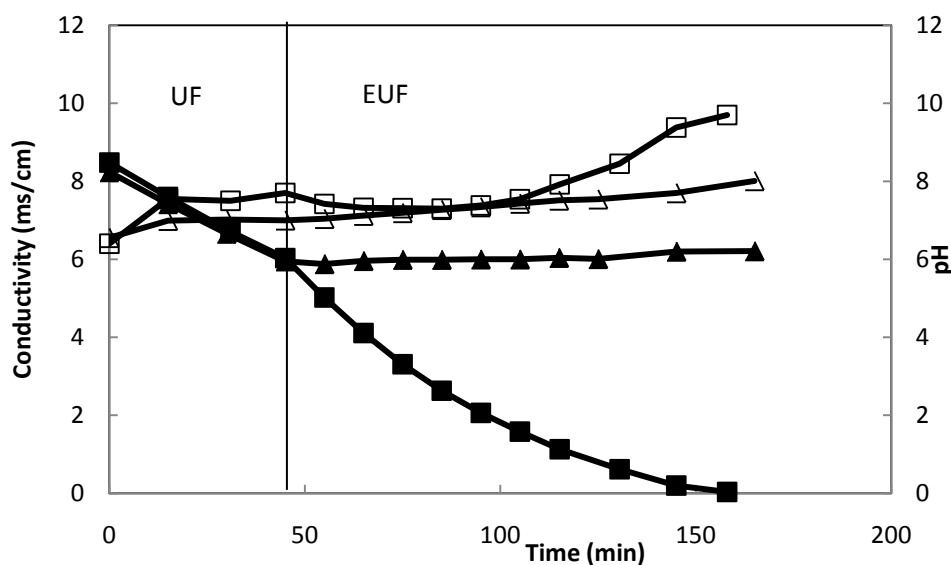

Figure 3.10 Conductivity and pH changes in permeate compartment during EMF of Lys, (■) Conductivity +UF- (□) pH +UF- (▲) Conductivity -UF+ (△) pH -UF+

It is interesting to see how voltage evolves and correlates with operation parameters. Figure 3.11 shows the voltage evolution both in Glu and Lys experiments at constant current 0.4 A at both polarities.

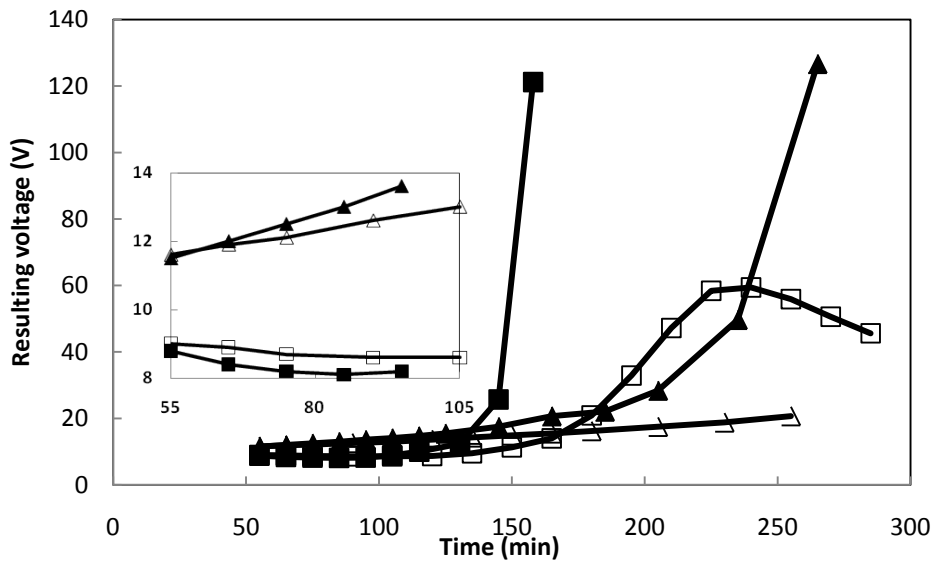

Figure 3.11 Variations of the resulting voltage in different operation conditions during EMF of Glu and Lys at current density 40A/m^2 , (\blacksquare) +UF-, $\text{Lys}^+(\blacktriangle)$ -UF+, $\text{Lys}^+(\triangle)$ -UF+, $\text{Glu}^-(\square)$ +UF-, Glu^-

After applying electric field in the first 1 hour, the voltage in each experiment was quite stable. The voltage obtained when operating at polarity +UF- was little bit higher than that of operating at polarity -UF+. This is because at polarity +UF-, resistance was higher than that of -UF+ due to the desalination effect taking place in the permeate compartment. A dramatical increase of voltage was both observed at late point of the experiments when operating with positively charged Lys. This could be due to the transport of Lys into the electrolyte compartment resulting in the increase of resistance. The variation of voltage during the experiments was mainly related with the conductivity change in the permeate compartment.

3.3.2.3 Relation between flux and polarity

EMF has been proved to be an effective way to improve the flux because it could help reduce the concentration polarization layer. Even though the molecular weight of amino acid is 100 times smaller than the UF membrane cut-off, it is still interesting to see if electric field has depolarization effect.

It is not surprised to see that the flux increased at polarity +UF- when operating with negatively charged Glu as Figure 3.12 shows (compared with flux obtained from UF operation). This improvement of flux could be explained by the depolarization effect that electric field imposes.

Surprisingly, a decrease of flux was observed when operating at polarity $-UF^+$. This indicated that the negatively charged Glu has tendency to foul the membrane at polarity $-UF^+$ due to the electrophoretic effect which dragged Glu towards the membrane surface. However, if we compared the permeate flux in Figure 3.12 at first 45min with water permeability, it turns out the permeate flux was at the same level (even little bit higher) with water permeability which proved that Glu has no fouling effect on the membrane. This pointed out that there must be other effects influencing the flux change instead of electrophoretic effect.

The flux change of the Lys experiments was further investigated, interestingly, flux also increased at polarity $+UF^-$ and decreased at polarity $-UF^+$ as Figure 13 shows. This observation was just opposite to one could expect from the depolarization effect that electric field brings. Choe *et al.* [125] reported the flux increased due to electroviscous effect upon the addition of salt into feed solution. This statement was in accordance with the fact that the conductivity of feed solution increased at polarity $+UF^-$ which resulted in electroviscous effect.

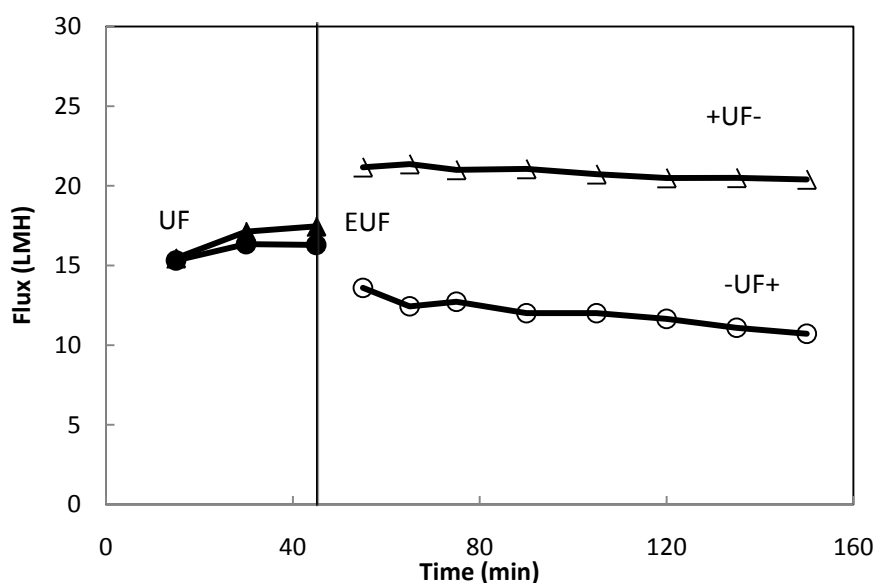

Figure 3.12 Flux change by applying electric field both at polarity $+UF^-$ and $-UF^+$ during EMF of Glu-, (\blacktriangle) 0.28bar 0 A/m² (\triangle) 0.28bar 40 A/m² at polarity $+UF^-$ (\bullet) 0.28bar 0 A/m² (\circ) 0.28bar 40 A/m² at polarity $-UF^+$

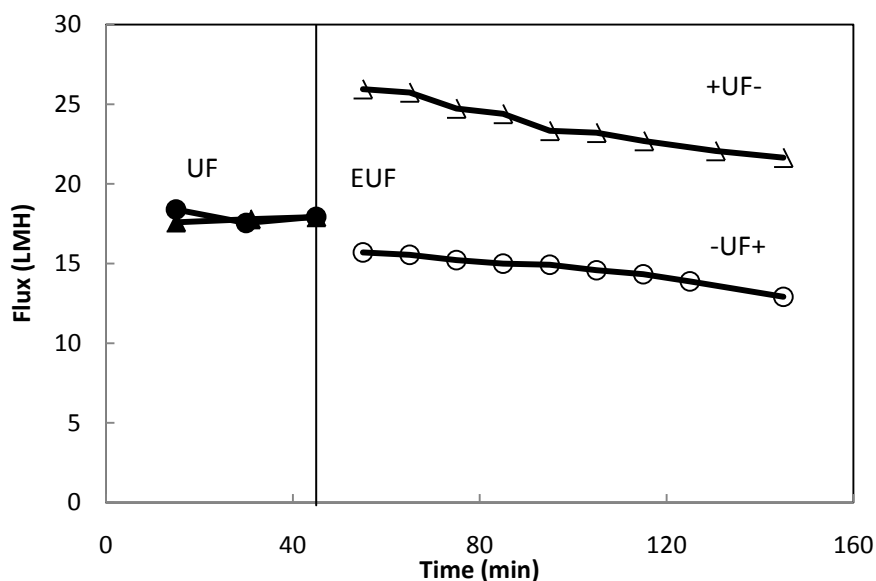

Figure 3.13 Flux change by applying electric field both at polarity +UF- and -UF+ during EMF of Lys+, (\blacktriangle) 0.28bar 0 A/m² (\triangle) 0.28bar 40 A/m² at polarity +UF- (\bullet) 0.28bar 0 A/m² (\circ) 0.28bar 40 A/m² at polarity -UF+

3.3.3 EMF separation of amino acids

It has been found that positively charged Lys can pass through cation exchange membrane thereby into electrolyte compartment. Therefore, separation of amino acids based on charge can only be limited to neutral and negatively charged amino acids. Under this circumstance, Leu and Glu were chosen as the model amino acids in the studies of binary mixture separation using EMF. Separation can be expected to achieve when one amino acid is neutral and the other is negatively charged. The negatively charged amino shall be held back in feed in the competition between electrophoretic force and TMP and the neutral one shall migrate to permeate due to convective transport. Therefore, the polarity has to be fixed at +UF-. Figure 3.14 shows the main transport phenomena taking place during EMF separation of negatively charged Glu and neutral Leu.

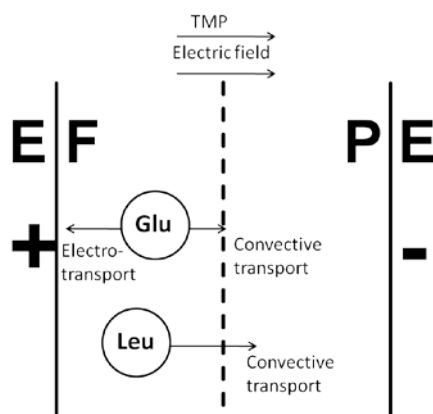

Figure 3.14 Schematic presentation of main transport phenomena taking place during EMF separation of Glu and Leu, E: electrolyte compartment; F: Feed compartment; P: Permeate compartment

Experiments listed in Table 3.3 were performed; the experimental conditions and objective of each experiment are also presented in the following table.

Table 3.3 Summary of experimental conditions for EMF of binary mixture Glu and Leu

Binary mixture separation using EMF	Electrode Polarity	Initial feed solution		Initial permeate solution	Current (A/m ²)	TMP (bar)
		Glu (mM)	Leu (mM)			
To investigate whether EMF can be used to separate Leu and Glu	+UF-	11	10.8	50mM Na ₂ SO ₄	0; 40	0.3
	+UF-	10.5	10.9	50mM Na ₂ SO ₄	0; 60	0.5
To investigate how the parameters, current density and TMP affect the separation performance	+UF-	10.8	10.8	50mM Na ₂ SO ₄	40	0.3
	+UF-	10.3	10.5	50mM Na ₂ SO ₄	60	0.5
	+UF-	10.3	10.7	50mM Na ₂ SO ₄	60	0.3
	+UF-	10.5	10.9	50mM Na ₂ SO ₄	40	0.5

3.3.3.1 EMF and UF in the application of amino acids separation

In order to investigate whether EMF can be used to separate amino acids, reference experiments performed with normal UF filtration were conducted before EMF experiments. The objective of carrying out those experiments is to demonstrate feasibility of EMF on amino acid separation which normally is not possible to achieve with UF filtration.

Figure 3.15 shows the permeate concentration changes of Glu and Leu with and without applying electric field. According to Figure 3.1 and 3.2, Glu is negatively charged and Leu is neutral at pH range of 6-7. In the first 60 min, the system was operated in a normal UF membrane manner at TMP 0.3 bar and 0.5 bar, respectively. The electric field was applied from 60 min at current density 40 and 60 A/m².

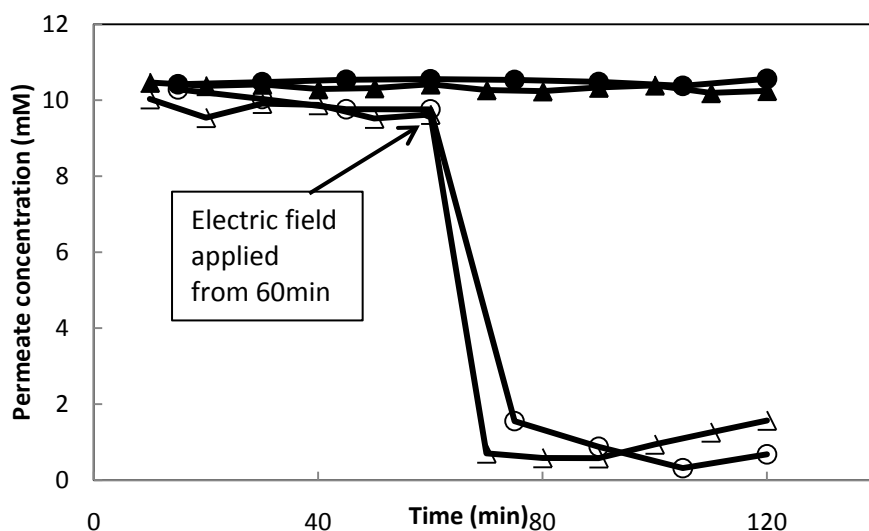

Figure 3.15 The permeate concentrations of Glu and Leu obtained without and with electric field applied at polarity +UF-, pH of feed solution stayed at 6.6 ± 0.2 (▲) Leu at 0.5 bar and 60 A/m² (△) Glu at 0.5 bar and 60 A/m² (●) Leu at 0.3 bar and 60 A/m² (○) Glu at 0.3 bar and 40 A/m²

As can be seen from Figure 3.14, the permeate concentration of both Glu and Leu stayed almost the same as their respective feed concentration indicating the transmissions of Glu and Leu through UF membrane were more or less the same thereby separation between Glu and Leu was not achieved. From 60 min when applying the electric field at polarity +UF-, the permeate concentration of Glu decreased rapidly due to electrophoretic force dragging it away from the UF membrane and the

permeate concentration of Leu was not affected. Therefore, separation between these two amino acids was achieved.

The permeate flux in both cases increased when electric field was applied, which probably was due to electroviscous effect as described in Figure 3.12 and 3.13. In the case of TMP 0.5bar, average permeate flux increased by 23% from 27.2LMH to 33.4LMH by applying 60 A/m² current density. In the case of TMP 0.3bar, average permeate flux increased also by 23% from 16.2LMH to 19.9LMH by applying 60A/m².

Table 3.4 shows that the selectivity and purity obtained both at normal UF and EUF at different combinations of TMP and current. Selectivity obtained from UF of Glu and Leu was nearly at unity indicating separation can hardly be achieved. By applying the electric field, separation of Leu from Glu can take place as the selectivity increased more than unity. Higher selectivity and purity was obtained when operating at 0.5bar & 60 A/m² than at 0.3bar & 60 A/m² for 60min after normal UF filtration. This indicates that by carefully choosing current density and TMP, better separation performance can be expected.

Table 3.4 Summary of the selectivity and purity at 60 min of UF and 120 min of EMF (60 min after applying current)

TMP (bar)	Current density (A/m ²)	$S_{Leu/Glu}$	f_{Leu} (%)
0.5	0	1.02	51.2
	60	7.3	86.7
0.3	0	1.07	51.1
	40	16.8	94

3.3.3.2 Studies of the parameters influencing separation

Conventional UF membrane separation based on the molecular size difference has been proved impossible for the application of Glu and Leu separation, while in the presence of electric field in

UF membrane process separation could take place as the above mentioned data show. It has also been demonstrated that separation performance can be tuned by choosing different combination of current density and TMP. In this section, investigation of the effects of different combination of current density and TMP on separation performance was performed.

Figure 3.16 shows the permeate concentration changes of Glu and Leu obtained from different combination of TMP and current density. For example, by increasing the TMP from 0.3 to 0.5 bar while keeping current density the same at 60 A/m^2 , we can see that the permeate concentration of Glu increased slightly and permeate concentration of Leu stayed almost the same. The increase of Glu permeate concentration was due to the increase of convective transport in the competition with electrotransport. And the mass transport of Leu was only governed by convective transport. Since the UF membrane has hardly any selective to amino acids, permeate concentration of Leu shall not be influenced by the change of current density and TMP. Likewise, by increasing the current density from 40 to 60 A/m^2 while keeping TMP the same at 0.3 bar , we can see that the permeate concentration of Glu decreased and again permeate concentration of Leu stayed more or less the same. Again, the change of Glu permeate concentration was due to that whether mass transport was enhanced or decreased resulted from the competition between convective and electrotransport.

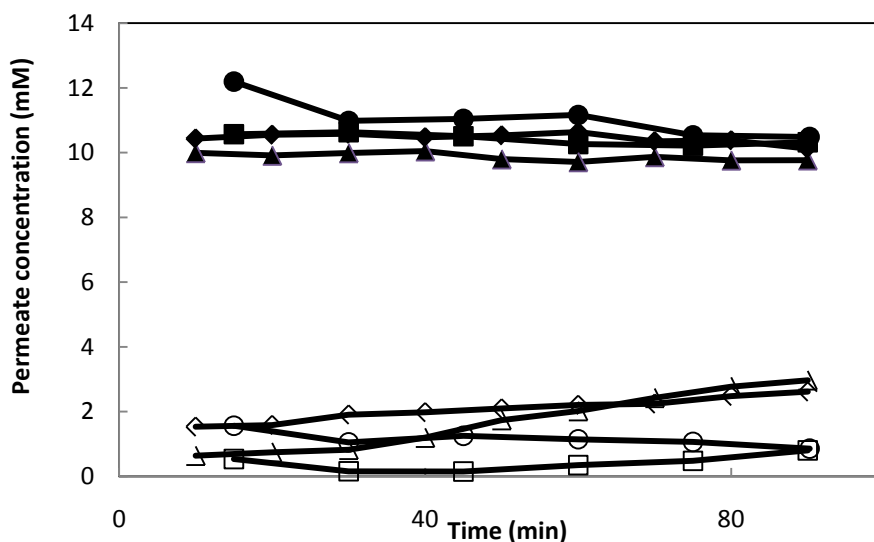

Figure 3.16 The concentration change of Leu and Glu in permeate compartment at different combinations of current and TMP at polarity +UF- (■)Leu at 0.6 A 0.3 bar (□)Glu at 0.6 A 0.3 bar (▲)Leu at 0.6 A 0.5 bar (△)Glu at 0.6 A 0.5 bar (●)Leu at 0.4 A 0.3 bar (○) Glu at 0.4 A 0.3 bar (◆)Leu at 0.4 A 0.5 bar (◇)Glu at 0.4 A 0.5 bar

Moreover, as Table 3.5 shows, the selectivity and Leu fraction in permeate were very much dependent on the operational parameters. When operating at combination of current 60A/m² and TMP 0.3 bar, selectivity 30.4 and purity 96.7% can be obtained at 60min (the highest selectivity 89 was obtained at the beginning of the experiment). While selectivity 5.0 and purity 82.8% were obtained when operating at a combination of current 40A/m² and TMP 0.5 bar. Therefore, operating at the same TMP 0.3 bar while increasing the current from 40 A/m² to 60 A/m² improved the selectivity enormously. However, the improvement of selectivity didn't show so obviously when increasing the current from 40 A/m² to 60 A/m² operating the same TMP 0.5 bar. Therefore, it can be concluded that operating at relative lower TMP, the increase of current can improve the separation more effectively.

In Table 3.5, the observed rejections of Glu at each operation condition were also shown. The highest rejection was obtained when the difference of two driving forces due to electric field strength and TMP was the largest. The rejections of Glu decreased during the experiments. This was due to the decrease of electric field strength in the feed compartment resulted from the increase of feed conductivity. According to Eq.[10] in chapter 2, the decrease of the electric field strength was the result of the increase of feed conductivity. This was just the case in all the experiments.

Table 3.5 Summary of the selectivity and purity obtained at 60 min from each experiment during EMF of Glu and Leu

Current density (A/m ²)	TMP (bar)	$S_{Leu/Glu}$	f_{Leu} (%)	$R_{obs(Glu)}$ (%)
60	0.3	30.4	96.7	96.9
60	0.5	5.6	82.8	83.8
40	0.3	10.4	90.7	90.1
40	0.5	5.0	82.8	80.6

3.3.3.2.1 Permeate conductivity and permeate pH

We have found out that in section 3.3.2, pH change in the permeate compartment due to that the electrolytic reactions took place when the permeate conductivity was in shortage. This phenomenon happened again in the separation experiments especially after 2 hours. In order to prevent

electrolytic reaction, one shall keep permeate conductivity at relative high level. Titration of Na_2SO_4 in permeate during the experiment was studied in order to keep pH constant. However, separation performance was not improved by controlling the permeate pH. Interestingly, selectivity and purity were both improved by the increase of permeate pH due to the electrolytic reactions. This was because that the pH change made both Leu and Glu negatively charged in the permeate stream and were therefore transported back to the feed. The back transport of Glu was more pronounced than that of Leu because Glu was more charged. In this sense, selectivity and purity were improved.

3.3.4 Electro-diafiltration

In pressure driven membrane systems, the purification of a molecule is generally achieved by diafiltration only if one of the solutes can pass through the membrane while the other is rejected. Hence, in the application of Glu and Leu separation using diafiltration in a normal pressure driven membrane process is definitely impossible. By applying the electric field in diafiltration in our system, it is possible to achieve separation as Figure 3.17 shows. In Figure 3.17, the ratios of feed concentrations relative to original feed concentrations are plotted against the diafiltration time.

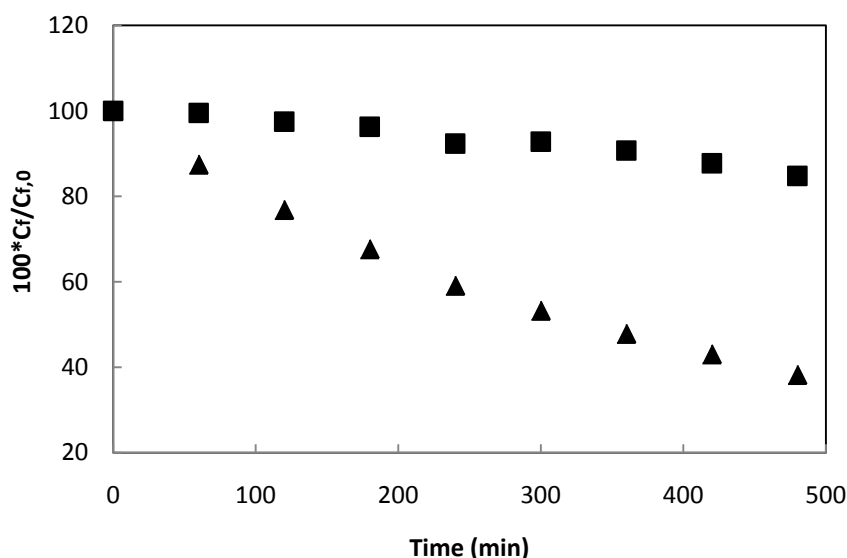

Figure 3.17 Changes of concentration ratio relative to the original feed concentrations of Leu and Glu during electrodiafiltration at polarity +UF-, current density 40 A/m^2 , TMP 0.5 bar; 1.2L addition of water during the diafiltration of 1.1 L feed solution. Initial feed solution consisted of

11.9 mM Glu and 9.9 mM Leu, the feed pH stayed at around 6.6 during the experiment; initial permeate solution was 0.05 M Na₂SO₄, (■) Glu (▲) Leu

As can be seen in Figure 3.17 that Leu was substantially removed after 4 hours diafiltration (feed volume kept constant) and due to the decrease of electric field strength Glu was also slightly removed. However, there is no advantage of using diafiltration in EMF i.e. selectivity and purity were not improved as compared with operating just with EMF. The cost of water consumption and energy consumption is another hindrance to using electro-diafiltration in the application of amino acids separation. But when it comes to enzymes fractionation where there is concentration polarization and fouling effect, the application of diafiltration in the presence of electric field can accelerate the separation. This is because the application of an electric field can remove one enzyme from the diffusive layer therefore increase the net flux, as a side effect, an increase transmission of the other enzyme. But long operation time with diafiltration should be taken into account since protein denaturation could occur in a long residence time.

3.4 Conclusions

In the present work, amino acids were used as model to investigate the possibility of using EMF to separate charged components. The experimental studies were carried out with solution of increasing complexity, i.e. first single amino acid solution then binary mixture.

This work clearly points out:

- Electric field had big effect on the transport of charged amino acid, depending on the polarity it either enhanced or weakened the transport.
- The combination of an electric field with a pressure driven membrane process could be used to uncouple the transport of different species such as charged solute and uncharged solute. In this work, this combination has been successfully applied to separate Leu from Glu with high separation factor and purity, which normal UF cannot achieve.
- The selectivity and purity could be tuned by using different combinations of current and TMP.
- Electrolytic reactions leading to pH change in the system took place when permeate conductivity was in shortage. Hence, permeate conductivity was crucial to control the pH in the system. However, data shows that controlling the pH did not necessarily improve the separation performance.
- The electric field can be successfully applied in the diafiltration mode to separate amino acids.

- EMF has great potential to separate enzymes with different charges.

Chapter 4

EMF of bovine serum albumin

In this chapter, bovine serum albumin (BSA) was selected as a model protein to investigate and understand the transport phenomena of protein both in a normal membrane filtration module and an electro-membrane filtration module. Two different kinds of membranes, a 10KDa cut-off UF membrane and a 0.2 μm MF membrane were used in this study. Materials and methods used in this study are first described in section 4.2. Experimental results are presented in section 4.3. First part of section 4.3 is presented in 4.3.1, where filtration with a UF membrane in the absence of electrical field (normal crossflow UF filtration) and filtration in the presence of electrical field (EUF) will be presented. In this part, two experiments operated in a normal UF filtration module were performed in order to understand how the flux and BSA permeate concentration change as function of trans-membrane pressure (TMP) and as function of time at a constant TMP. Then experiments of UF filtration in the presence of electrical field (EUF) were carried out in order to investigate the effects of feed pH and polarity on the filtration performance. Membrane fouling tendency characterized by the water permeability before and after each experiment was compared among all the experiments done in this study. Second part of section 4.3 is presented in 4.3.2, where similar experiments were carried out using an MF membrane. First, normal MF filtration of BSA as function of TMP and as function of time at constant TMP is presented. Then normal MF filtration of BSA at 4 different feed pHs is discussed. Some of the experiments of MF filtration in the presence of electrical field (EMF) were also carried out. Rejection and permeation flux are the two parameters used to compare the filtration performance in all the experiments. Membrane fouling tendency characterized by the water permeability before and after each experiment was compared among all the experiments done in this study. Likewise, a summarization comes as last part. In electro-membrane filtration, variations of the resulting current, pH and conductivity both in feed and permeate compartments were recorded during the experiments. In section 4.5, some of the conclusions especially the recommendations for the enzymes separation are drawn based on those results.

4.1 Introduction

BSA was selected as model protein was due to the fact that it is well studied model solution. In the operation of electro-membrane filtration, the charge of molecular is the key factor to determine the transport. Therefore, it is very important to know how the charge of molecular with respect to the solution pH. Zeta potential is a physical parameter that describes surface charge on proteins. The zeta-potential of BSA as function of pH taken from Horiba is presented in Figure 4.1.

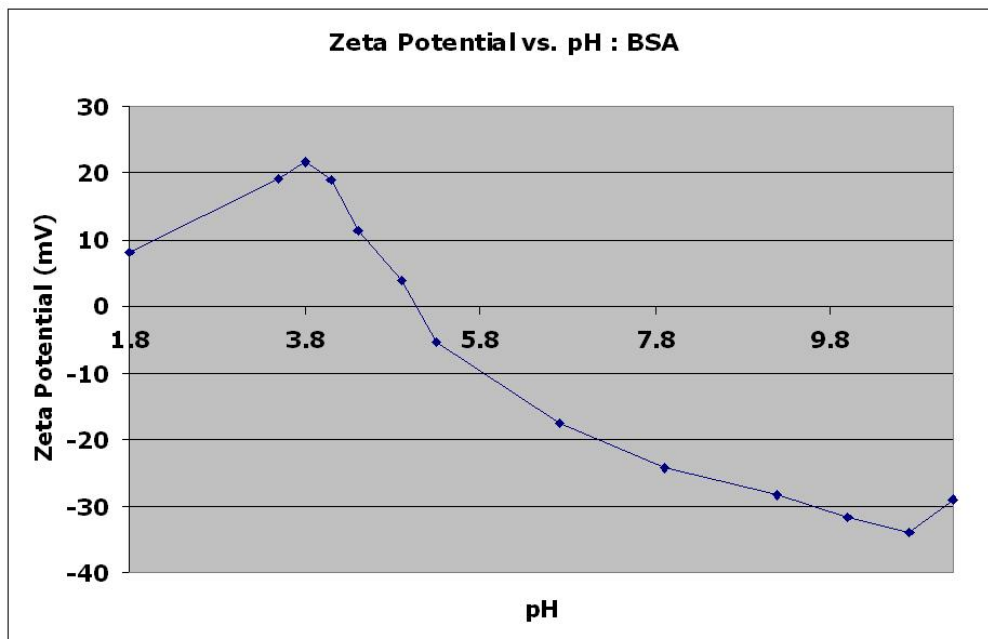

Figure 4.1 Zeta-potential of BSA as function of solution pH, measured by Horiba [126]

From the plot, we can see that the pI of BSA is around 4.7, which is exactly the same with the result we got from IEF experiment. We can also easily determine the charge condition of BSA at a specific pH, which is extremely important for us to make a hypothesis of BSA transport under the influence of electrical field. Based on that hypothesis, the rejection and permeation flux can also be estimated as compared to normal UF filtration.

4.2 Materials and Methods

BSA in the form of lyophilized powder (purity $\geq 96\%$) was purchased from Sigma -Aldrich, and it was stored in the fridge when it's not used. BSA has molecular weight (MW) around 66KDa and has pI at around 4.7 (confirmed by the IEF experiment). The feed solution of BSA for the

experiments was prepared by dissolving the BSA in deionized water (dH₂O). The pH of feed solution was adjusted to a certain value by adding 0.1M NaOH or 0.1M HCl. The concentration of the BSA solution was analyzed by UV Spectrophotometer (PERKIN-ELMER 320) with quartz cuvette at wavelength 280nm. The two membranes used in this study were donated by Alfa Laval Denmark. The UF membrane ETNA 10PP has 10KDa cut-off, which was claimed to have anti-fouling property. The microfiltration membrane GRM made from polysulfone has pore size of 0.2 μ m, which is supposed to be more hydrophobic than the ETNA 10PP membrane.

There are two ways of operating the UF and MF filtration in the absence of electrical field in our system. The normal manner (here we called it conventional UF/MF operation) is that there is no permeate solution fed into the permeate reservoir and the permeate solution is not circulated by the pump. The other operation manner (called new UF/MF operation) is that 300ml 50mM Na₂SO₄ permeate solution is fed into the permeate reservoir, the sample is taken via an over flow in the permeate reservoir during certain time period. With the new UF operation manner, the volume of the permeate solution is always kept 300ml after collecting sample. In all the cases of filtration in the presence of electrical field, the second operation manner was employed. In UF/MF filtration in the absence of electrical field, both of the operation manners can be used. It will be indicated in the respective section what operation manner is used.

All the experiments done in the studies are presented in each section below according to the unit operations. The details of all the experiments will be presented as well. Pure water flux was checked before and after each experiment just to get idea of how much fouling the membrane has after experiment. The sequence of experiments was numbered in chronological order of the time that those experiments were done. For instance, Nr.1 was the experiment which was done ahead of all the rest of the experiments. The recirculation flow rates of permeate and electrolyte solution were at a rate of 22L/h and 60L/h respectively. The crossflow velocity was 1.25×10^{-2} m/s.

4.2.1 UF filtration experiments

Two experiments of UF filtration of BSA were carried. The operation conditions and details are presented in Table 4.1 in the Results section 4.3.1.1. The conventional UF operation manner was employed. In each experiment, 2.5g BSA was dissolved with dH₂O into the feed reservoir (around 2.5L) as feed solution.

4.2.2 EUF filtration experiments

EUF filtration of BSA starting with initial feed concentration at 0.95 ± 0.5 g/L was carried out at constant electric field strength (909V/m) at both polarities. BSA solution was initially fed into the feed reservoir, then titrated to a certain pH, 50mM Na_2SO_4 and 100mM Na_2SO_4 were fed into the permeate and electrolyte reservoir respectively.

8 experiments were carried out at constant electric field strength 909V/m with different feed pH and polarity. In each experiment, 2.5g BSA was dissolved with dH_2O and then fed into the feed tank. Dependent on what pH is required, 0.1M NaOH or 0.1M HCl was used to titrate the solution. According to Figure 4.1, 4 representative initial feed pHs were tried, the first pH was around 3.5 where BSA was positively charged, the second one was around 4.6 where BSA was almost neutral, the third one was pH 7 at which BSA solution exists with titration, the fourth one was around pH 9.5 where BSA was negatively charged. Except at pH7, the others three pHs have to be titrated by NaOH or HCl. For each pH value, two experiments with polarity +UF- (anode on the retentate side) and -UF+ (anode on the permeate side) were studied. All the details and operation conditions are presented in Table 4.2 in the Results section 4.3.1.2.

4.2.3 MF filtration experiments

5 experiments of MF filtration of BSA were carried out. The first two experiments were carried out to characterize the membrane. Then another 3 experiments were conducted to investigate the effect of feed pH on filtration. The operation conditions and details are presented in Table 4.3 in Results section 4.3.2.1. The conventional MF operation manner was employed in Exp. Nr.1 and 2. And the new operation manner was employed in Exp. Nr.5, 7 & 10. In each experiment, 2.5g BSA was dissolved with dH_2O into the feed reservoir (around 2.5L) as feed solution.

Another three experiments were carried out in a normal MF operation manner in order to investigate if the operation manner does affect on the filtration performance in terms of BSA rejection and permeate flux. Details are presented in Table 4.4 in the Results section 4.3.2.1.3.

4.2.4 EMF filtration Experiments

4 experiments were conducted with different feed pH at the same constant TMP. Polarities were also tested. In each experiment, 2.5g BSA was dissolved with dH_2O (gave concentration around

1g/L) and then fed into the feed tank. EMF filtration of BSA starting with initial feed concentration was carried out at constant electric field strength (909V/m). BSA solution was initially fed into the feed reservoir, then titrated to a certain pH, 50mM Na₂SO₄ and 100mM Na₂SO₄ were fed into the permeate and electrolyte reservoir respectively. Dependent on what pH is required, 0.1M NaOH or 0.1M HCl was used to titrate the solution. Details can be referred to Table 4.5 in the Results section 4.3.2.2

4.3 Results and discussion

4.3.1 Filtration with UF membrane

The 10KDa anti-fouling ETNA-10PP membrane was used both in normal UF filtration and EUF. BSA MW is much bigger than the membrane cut-off, therefore it can be expected that the rejection of BSA is high.

In the first part, as described in section 4.3.1.1, normal UF of BSA as function of TMP was studied in order to investigate the best operating TMP in terms of the best energy consumption and most sustainable permeation flux. When the optimal TMP was obtained, filtration of BSA at this constant TMP was studied in order to see filtration performance as function of time. In the second part, which was described in section 4.3.1.2, EUF was then studied. The idea of this study is to Figure out how the BSA transport behaves when electrical field is applied as compared to the case when no electrical field is applied. The rejection and flux are the two parameters that we used for evaluating the filtration performance. It can be expected that the rejection and flux should have difference behavior as compared to the normal UF filtration. The effects of feed solution pH and polarity were studied in this part.

4.3.1.1 UF filtration of BSA

The purpose of carrying experiments with UF filtration was to characterize the membrane filtration performance when operating in normal UF filtration manner. It can give ideas about how the filtration performance is as function of TMP and time at constant TMP. Rejection and permeation flux are the two parameters that we look at the filtration performance. The experimental conditions of the two experiments were listed in Table 4.1.

Table 4.1 Experimental conditions and of UF filtration of BSA (the range of concentration was presented for concentration at the start and end of each experiment, and indicated the variation trend)

Exp. Nr.	Feed concentration (g/L)	TMP (bar)	Feed pH	Charge of BSA	Note
A	1.19-1.07	TMP increased gradually	6.9±0.1	-	No titration of feed solution
B	0.93-1.42	1.37	6.9±0.1	-	No titration of feed solution

4.3.1.1.1 Flux and rejection change as function of TMP and time

In order to see how the permeation flux and BSA rejection behave with respect to TMP, data from Exp. Nr.A is plotted in Figure4.2.

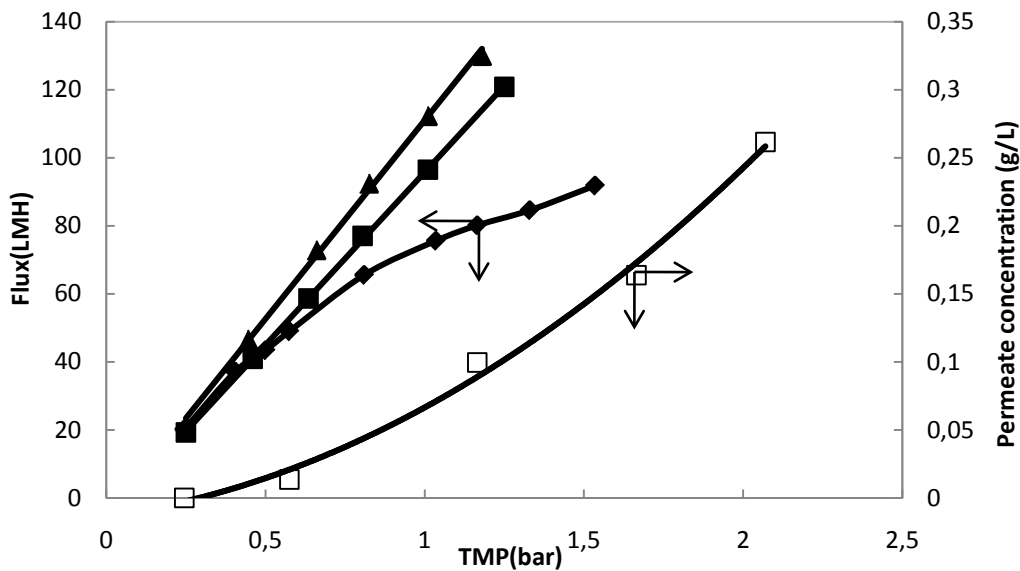

Figure 4.2 Permeation flux and permeate concentration of BSA as function of TMP from Exp. Nr.A during UF of BSA (refer to Table 4.1, UF filtration of BSA at pH around 7)(■)H₂O flux after exp.(▲) H₂O flux before exp. (◆)Permeate flux during exp.(□)BSA permeate concentration

In this plot, it can be seen that the pure water flux through the membrane is proportional to the applied hydrostatic pressure i.e. TMP. Unlike the pure water flux behaves, the permeation flux increased with the increase of TMP, but after a finite TMP flux didn't increase proportional to TMP, it started being level off due to concentration polarization effect. This observation is in accordance as expected. In UF membrane filtration, the solute will be retained by the membrane which

accumulates at the surface of the membrane resulting in a concentration build-up. At steady state, the convective flow of the solute to the surface of membrane is equal to the diffusional back-flow from the membrane surface to the bulk solution. Further increase of the pressure will not generate an increase of permeation flux. This observation can be explained by the Gel layer model or Osmotic pressure model [21]. Permeate concentration of BSA also increased with the increase of TMP, as expected it didn't increase linearly with TMP due to the gel layer attained on the membrane surface or osmotic pressure caused by the BSA concentration difference between feed and permeate. The rejection at TMP 2.07 bar was 77% meaning that there was still BSA transported through the membrane even though the cut-off of membrane is relatively smaller than BSA MW.

TMP 1.37 bar was chosen for further study in order to investigate how the flux and rejection change at a constant TMP. Therefore Exp. Nr.B was carried out for 165 min. The permeation flux and permeate concentration of BSA are presented in Figure 4.3.

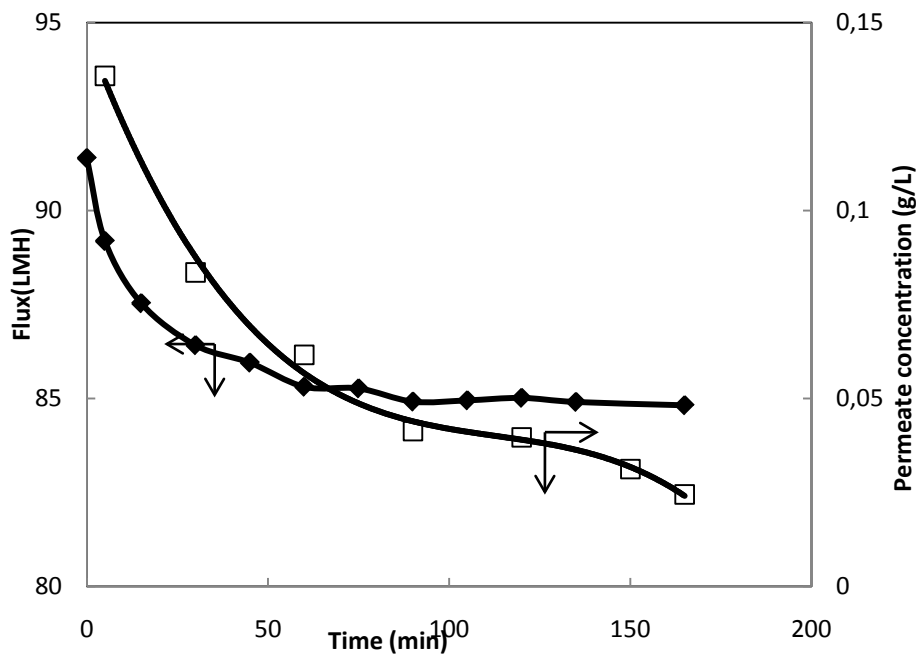

Figure 4.3 Permeate flux and permeate concentration of BSA at TMP 1.37bar from Exp Nr.B during UF of BSA (◆)Permeate flux (□)BSA permeate concentration

The permeation flux decreased slightly from 91LMH to 85LMH at first 1 hour then it stayed quite stable till the end of experiment. This indicated that the membrane has quite good property of anti-fouling.

Permeate concentration decreased with the time which indicated that permeation of BSA became less and less due to the concentration polarization and membrane fouling. After 1 hour, it can be found that even though the flux became stable the BSA permeate concentration still decreased. This indicates that the amount of BSA transported into permeate decreased due to the concentration build-up resulting in the increase of resistance of the boundary layer. Feed concentration went up to 1.42g/L at the end of the experiment. The rejection of BSA increased from 85.3% at the beginning to 95.3% at the end of experiment.

From these two experiments, we can see that the UF membrane has quite good property of anti-fouling because the permeation flux was quite constant when operating at TMP 1.37bar. The rejection of BSA at TMP 1.37bar was quite high as expected. It will be interesting to see how the rejection and flux behave when applying the electrical current.

4.3.1.2 EUF of BSA

In EUF, due to the effect of electrical field, the pH of feed solution which determines the charge condition of BSA and the electrode polarity are very important. The purpose of carrying out EUF experiments is to find out how much effect of electrical field on filtration performance with respect to feed pH and polarity. Therefore, experiments listed in Table 4.2 were carried out.

Table 4.2 Experimental conditions of EUF of BSA (neutral is indicated as 0)

Exp. Nr.	Feed concentration(g/L)	TMP (bar)	Electric field strength (V/m)	Feed pH	Charge of BSA	Operat-ion	Note
1	0.95-1.17	1.37	909	7.2±0.4	-	+UF-	No titration with feed solution; 909 V/m applied at the start
2	0.99-1.06-1.03	1.37	909	7.6±0.7	-	-UF+	No titration with feed solution; 909 V/m applied at the start
3	1-0.93	1.39	909	8.9±0.2	-	-UF+	909 V/m applied at the start
4	0.95-1.18	1,37	909	5±0.5	+0/-	+UF-	909 V/m applied after 10min of normal UF
5	0.93-1.24	1.39	909	5.4±1	+0/-	-UF+	909 V/m

6	0.92-0.87	1.4	909;1818	3.8±0.3	+	-UF+	applied after 15min of normal UF 909 V/m applied after 15min of normal UF; at 75min voltage increased to 1818V/m
7	0.95-0.95	1.4	909	9.7±0.2	-	+UF-	909 V/m applied after 10.5min of normal UF
8	0.95-0.91-1.01	1.39	909	3.7±0.2	+	+UF-	909 V/m applied after 15min of normal UF

As we would like to know the effects of electrical field on the filtration performance, therefore it is constructive and helpful to have expectation of each experiment in terms of the rejection and permeation flux change as compared to normal filtration at the same feed pH. The expectation of each experiment is presented in Table 4.3.

Table 4.3 Expectation of the rejection and permeation flux change during EUF of BSA as compared to normal UF filtration at the same feed pH, increase=+,decrease=-,no change=0

Exp. Nr.	Rejection (%)	Flux (LMH)	Note
1	+	+	Transport of BSA through membrane became slower, BSA is taken away from membrane, therefore help minimize polarization
2	-&+	-	Transport of BSA through membrane accelerate, therefore it helps build up the second layer then the rejection might increase
3	-&+	-	Transport of BSA through membrane accelerate, therefore it helps build up the second layer then the rejection might increase
4	+	-	Electrical field shall has no effect neutral BSA, however fouling and concentration polarization may cause flux decrease and rejection increase
5	0	0	Electrical field shall has no effect on neutral BSA
6	+	+	Transport of BSA through membrane became slower, BSA is taken away from membrane, therefore help minimize polarization
7	+	+	Transport of BSA through membrane became slower, BSA is taken away from membrane, therefore help minimize polarization
8	-&+	-	Transport of BSA through membrane accelerate, therefore it helps build up the second layer then the rejection might increase

4.3.1.2.1 Effects of electric field and feed pH on flux and rejection

The electric field imposes an electrophoretic force on the charged molecules. Depending on the charge condition of the feed solution, it is expected that the electric field can either help enhance the transport of charged molecules towards membrane or help drag the charged molecules away from the membrane surface. Due to the effects caused by electric field, it is also expected that the permeation flux and solute transmission or rejection can either decrease or increase.

The pH of feed solution determines the charge condition of BSA solution. Under the influence of electrical field, the charge of solute is a factor to determine the direction of solute migration. In the competition with convective transport due to applied pressure, electro-migration can either increase the rejection when electrical field pulls the solute away from membrane or decrease the rejection when it helps solute transport through the membrane.

In this section, discussion of how the feed pH at polarity +UF- and -UF+ influence the filtration performance in terms of flux and rejection will be held. The effects of electric field on permeation flux and solute rejection are investigated by comparing the results from operating normal UF filtration and EUF filtration. Variations of current, conductivity and pH will be presented in appendix. We first present the results from experiments being operated at polarity +UF- with different feed pH, then results from -UF+ will be followed.

4.3.1.2.1.1 At polarity +UF-

First, the permeate flux at different feed pH with normal UF filtration is shown in Figure 4.4. This is used for the later comparison with that from EUF.

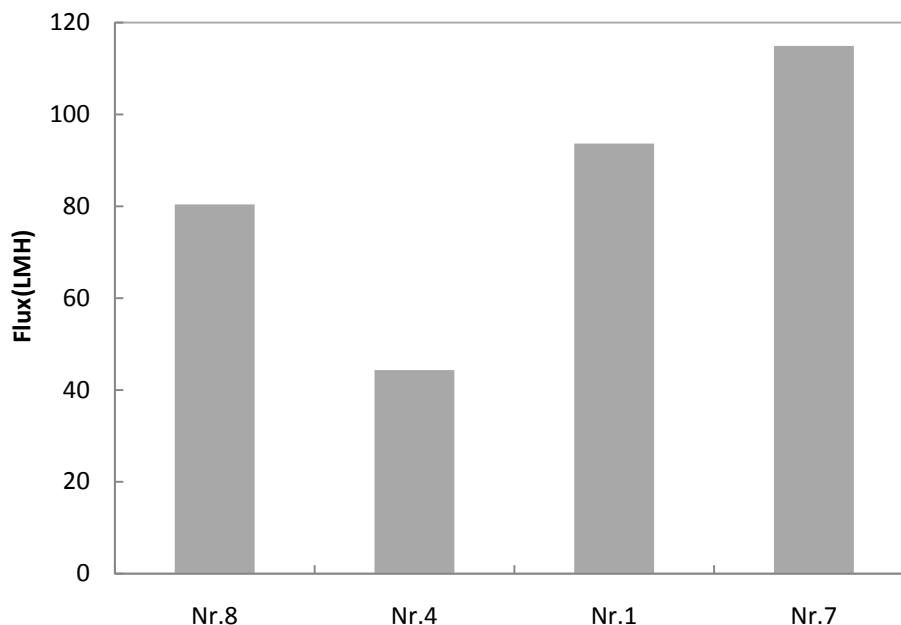

Figure 4.4 Comparison of the permeate flux obtained at different feed pH during UF of BSA (data obtained before the EUF operation); Exp. Nr.8 pH3.7±0.2, Nr.4 pH5±0.5, Nr.1 pH7.2±0.4, Nr.7 pH9.7±0.2

The permeate flux varied according to the pH of feed solution. In Exp. Nr.4, where the initial feed pH started at 5 close to pI of BSA gave the lowest flux compared to the other three. This is because at pH around 5, where BSA is neutral charged therefore the electrostatic membrane-protein and protein-protein interactions are at a minimum [127,128]. In addition, the proteins aggregate more easily at pI due to the lack of repulsive forces, which therefore causes more severe membrane fouling when the pH of the solution is close to the pI of the protein. Except at pH around 4.7, the flux in other experiments increased with the increase of feed pH. This was due to that the membrane and BSA probably have opposite charge thereby BSA was repelled from the membrane which resulted in low fouling.

In Figure4.5, the flux of the 4 experiments when operating in the presence of electrical field at polarity +UF- is presented. It is interesting to see how the flux changes when the electrical field is applied as compared to normal UF filtration.

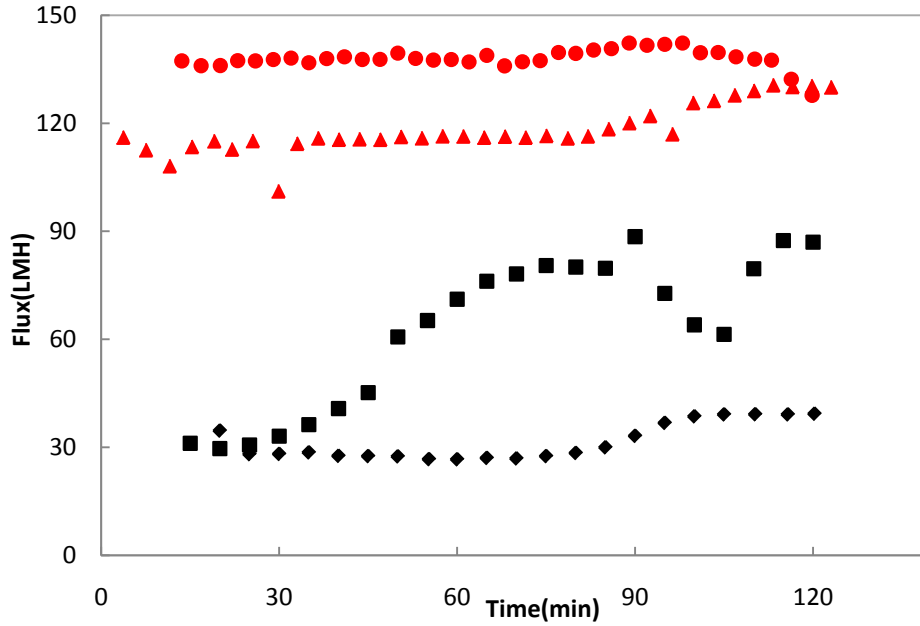

Figure 4.5 Comparison of the permeate flux changes obtained at different feed pH during EUF of BSA at polarity +UF- (◆)Nr.8, pH 3.7 ± 0.2 (■)Nr.4, pH 5 ± 0.5 (▲)Nr.1,pH 7.2 ± 0.4 (●)Nr.7,pH 9.7 ± 0.2

The flux from Exp. Nr. 8 in the presence of electrical field decreased almost half of the flux in UF filtration. This is in accordance with the expectation that is presented in Table 4.6. The observation of the flux from Exp. Nr. 1 and Nr.7 in the presence of electrical field was also in accordance with the expectation. Flux increased from 100 LMH to nearly 120 LMH after applying the electrical field in Exp. Nr.1. And in Exp. Nr.7, the increase of flux after applying the electrical field is more pronounced than in Nr.1, it increased from 115 LMH to 142 LMH at highest. The increase of flux after applying the electrical field is due to effect of electro-transport of BSA away from membrane under the influence of electrical field. We expected that the flux of Exp. Nr 4 in the presence of electrical field should keep the same level as compared in UF filtration. However, the flux after 30min increased and became fluctuated during certain period, the increase of the flux could be due to the increase of feed pH which eventually resulted in the change of BSA charge into negative.

The rejection obtained from the normal UF filtration among 4 experiments is presented in Figure 4.6.

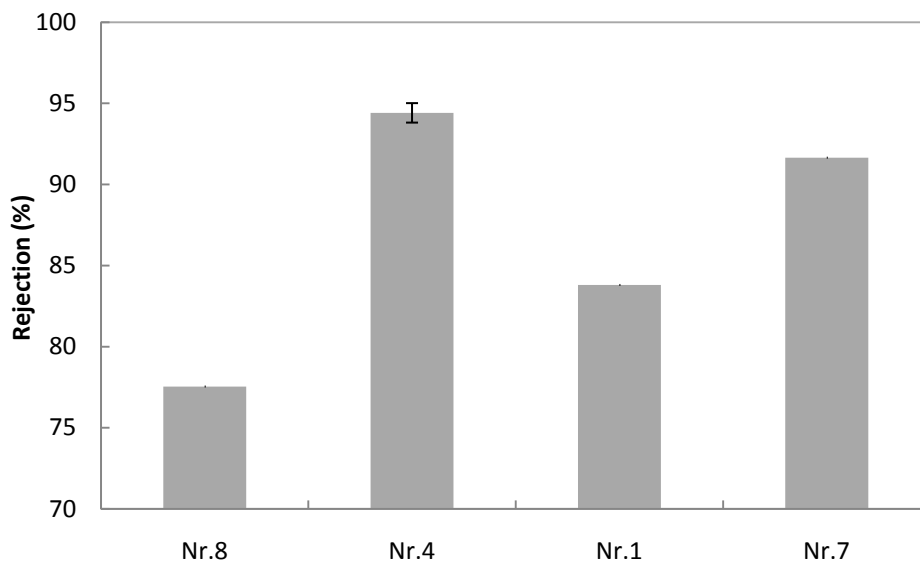

Figure 4.6 Comparison of the rejections obtained at different feed pH during UF of BSA, Exp. Nr.8 pH 3.7 ± 0.2 , Nr.4 pH 5 ± 0.5 , Nr.1 pH 7.2 ± 0.4 , Nr.7 pH 9.7 ± 0.2

The lowest rejection was observed in Exp. Nr. 8 and highest observed in Exp. Nr.4. The explanation for the highest transmission at around pH 5 was that electrostatic membrane-protein and protein-protein interactions are at minimum thereby the amount of protein adsorbed to the membrane surface is greatest [127-129]. It can also be due to the fact that the fouling layer of BSA is densest due to the lack of electrostatic repulsing at pI [130]. Huisman *et al.* [129] also reported that both the flux and transmission of BSA were the lowest at pH equal to pI when running crossflow UF experiment using PS membranes at cut-off values in the range of 30 to 300kDa. The rejections in Nr.1 and Nr.7 were both bit higher than in Nr.8, which could be due to interaction between membrane and BSA. In basic pH, the negatively charged BSA may have electrostatic repulsion from the membrane. While in acidic pH, the positively charged BSA may have electrostatic attraction with membrane.

We then compared the rejections obtained when applying the electrical field. This is presented in Figure 4.7.

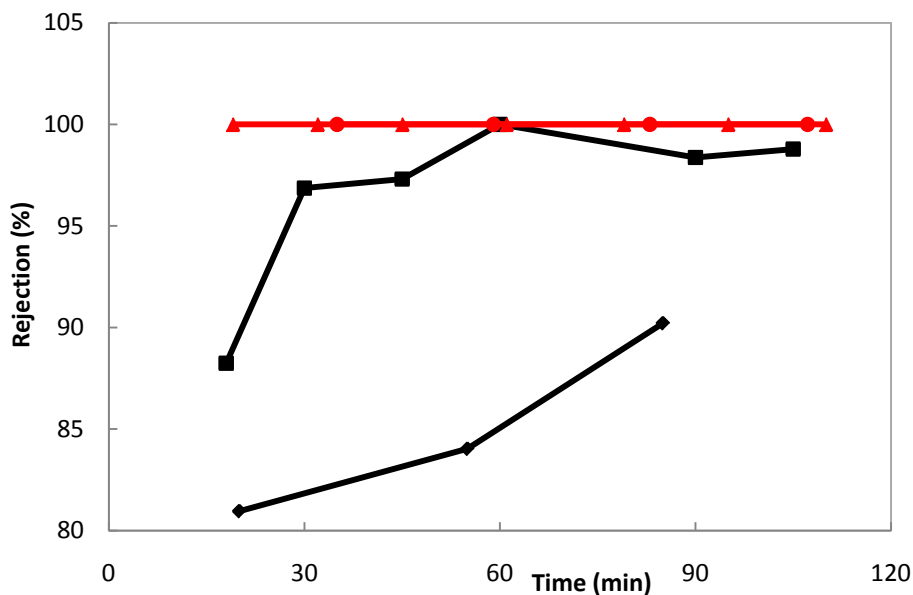

Figure 4.7 Comparison of the rejections obtained at different feed pH during EUF of BSA at polarity +UF-, (◆)Nr.8, pH 3.7 ± 0.2 (■)Nr.4, pH 5 ± 0.5 (▲)Nr.1, pH 7.2 ± 0.4 (●)Nr.7, pH 9.7 ± 0.2

As expected, the rejections both in Exp. Nr. 1 and Nr. 7 increased under the influence of the electrical field. In both cases of Exp. Nr. 1 and Nr.7, the rejection increased to 100% and stayed stable during the experiments. In the case of Nr. 8, the rejection first increased slightly then it increased faster, which probably is due to the second layer build-up under the influence of electrical field which resulted high resistance. In the case of Nr.4, the rejection first increased dramatically to a maximum value then decreased slightly. This was because electric field has no effect on the transport of neutral BSA. Due to TMP, BSA deposited more and more on the membrane surface thereby the rejection increased. The slightly decrease afterwards was due to dynamic change of BSA charge ascribed to pH change.

In the experiments, a DC power supply was used to apply constant potential across the electrodes and the resulting current variations were recorded during the experiments. Under the influence of the electrical field, electro-transport of BSA from feed compartment to permeate compartment was validated by the variations of pH and solution conductivity both for permeate and feed solution with time. Variation of the current, pH and conductivity with time during the electro-transport of BSA in the 4 experiments is presented in Appendix 1.

4.3.1.2.1.2 At polarity –UF+

Polarity determines the direction of electrical field strength, which influences the electro-transport of charged solute. We have presented the results from the experiments which were operated at polarity +UF- at four different feed pHs both with and without electrical field. In this section, the similar results from 4 experiments operated at polarity –UF+ at four different feed pHs are presented. Details of the experimental condition can be referred to Table 4.2.

Likewise, we first present the permeate flux of the four experiments obtained from normal UF filtration in Figure 4.8 in order to have later comparison with the results from EUF experiments.

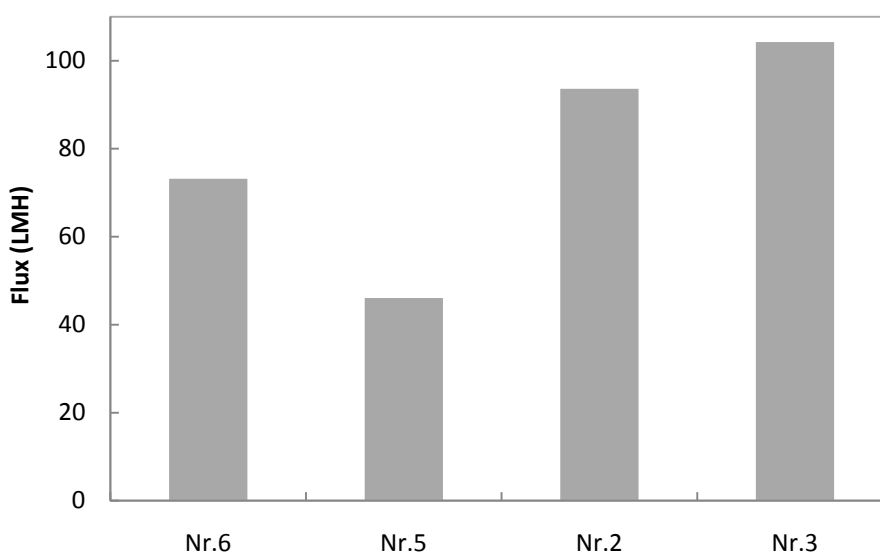

Figure 4.8 Comparison of the permeate flux obtained from different feed pH during UF of BSA (data obtained before the EUF operation); Exp. Nr.6 pH 3.8 ± 0.3 , Nr5 pH 5.4 ± 1 , Nr.2 pH 7.6 ± 0.7 , Nr.3 pH 8.9 ± 0.2

Similar results as Figure 4.4 shows were shown in Fig .4.11. The permeate flux varied according to the pH of feed solution. In Exp. Nr.5, where the initial feed pH started at around 4.4 (close to pI) gave the lowest flux compared to the other three. This is the same observation as Figure 4.4 presented. Again, except at pH around 4.4, the flux in other experiments increased with the increase of feed pH. We can confidently say that operating with feed solution at basic pH gives higher permeation flux than at acidic pH due to lower fouling caused by the membrane-BSA repulsion.

The permeate flux of 4 experiments after applying the electrical field is presented in Figure 4.9

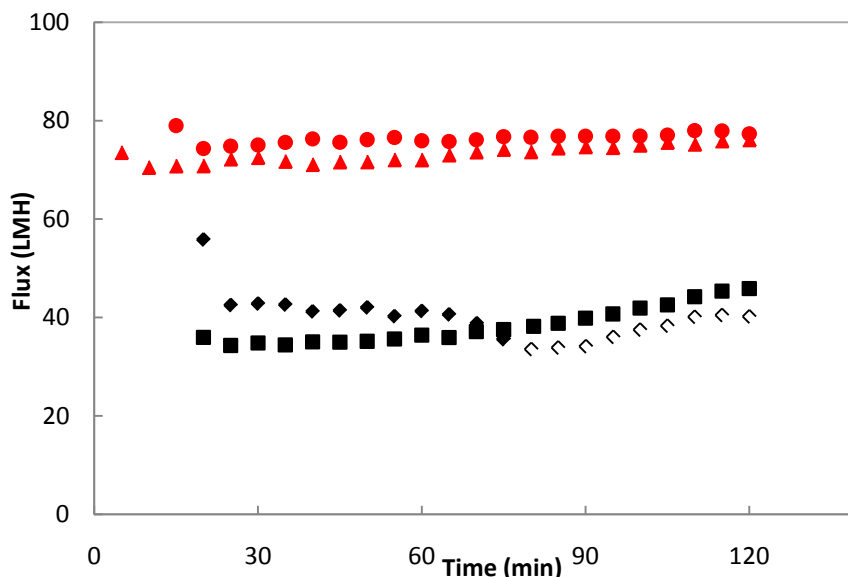

Figure 4.9 Comparison of the permeate flux changes obtained from different feed pH during EUF of BSA at polarity $-UF+$ (◆) Nr.6 pH 3.8 ± 0.3 , 909V/m (◇) Nr.6 pH 3.8 ± 0.3 , 1818V/m (■) Nr.5 pH 5.4 ± 1 (▲) Nr.2 pH 7.6 ± 0.7 (●) Nr.3 pH 8.9 ± 0.2

It is expected that the permeate flux of exp. Nr.6 should increase due to the depolarization effect under the influence of electrical field. However, what we see in the Figure 4.9 is that flux decreased after applying the electrical field. We have seen that in UF filtration experiments, feed solution at acidic pH resulted in lower flux than at basic pH, which indicated that at acidic pH BSA solution probably has electrostatic attraction with membrane. Since the pH was adjusted in the feed reservoir, there was a possibility that the interaction between BSA and membrane can take place immediately. BSA could cling to the membrane, even though the electrical field is supposed to depolarize the membrane surface, it might be not strong enough to drag the BSA on the membrane away from the surface of membrane. In this case, it seemed that BSA-membrane attraction was dominant. In Exp. Nr.5 where the initial feed pH was around 4.7 (pI of BSA), the flux after applying the electrical field didn't change too much from normal UF filtration, it decreased very little. Flux after 60min started increasing a bit which was due to the change of feed pH from around 4.7 to above 5. Both in the case of Exp. Nr.2 and Nr.3, the flux after applying the electrical field decreased slightly due to the electro-transport of BSA towards membrane, which then enhance the polarization effect. The flux of Exp. Nr.2 and Nr.3 is still higher than that of Nr.6 and Nr.5 which is the same situation as like at polarity $+UF-$. This further proved that this UF membrane is more easily to be fouled in acidic condition no matter there is electric field.

The rejections obtained when operating with UF filtration are presented in Figure 4.10.

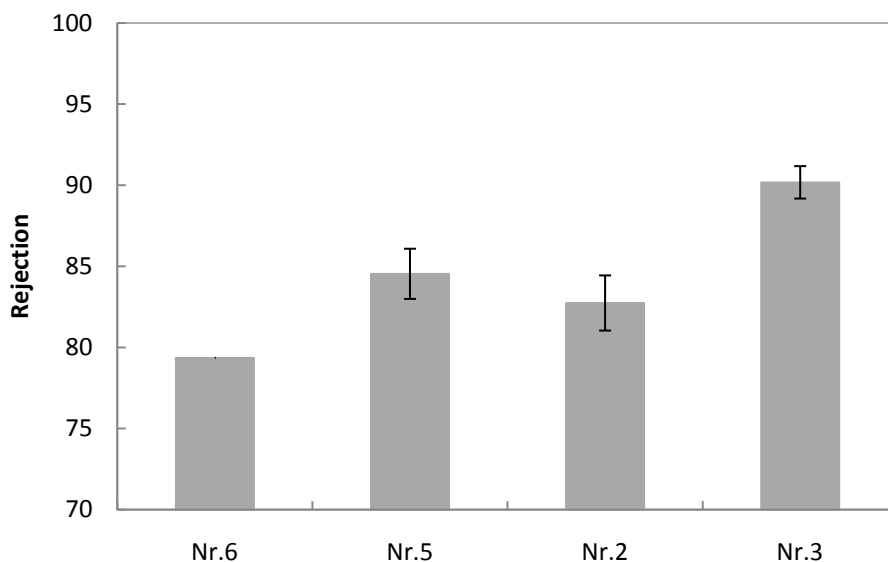

Figure 4.10 Comparison of the rejections obtained at different feed pH during UF of BSA, Exp.

Nr.6 pH 3.8 ± 0.3 , Nr.5 pH 5.4 ± 1 , Nr.2 pH 7.6 ± 0.7 , Nr.3 pH 8.9 ± 0.2

It can be expected that the results should be similar with that as Figure 4.6 showed because those experiments were operated at quite similar conditions. It can be seen from Figure 4.13, besides Exp. Nr.5, the rejection seemed to have correlation with the feed pH, it increased with the increase of feed pH, which again due to the electrostatic repulsion between negatively charged BSA and membrane. In Figure 4.6, the rejection of Exp. Nr.4 (pH near pI) was around 95%, however the rejection in Exp. Nr.5 was only 85% even though the operation conditions were quite alike. The difference of rejection can be due to the change of feed pH during experiments and to the dynamic, unpredictable interaction with membrane.

Due to the electro-transport under the influence of electrical field, the rejection shall change as compared to that in UF filtration. The rejections after applying the electrical field in each experiment are presented in Figure 4.11.

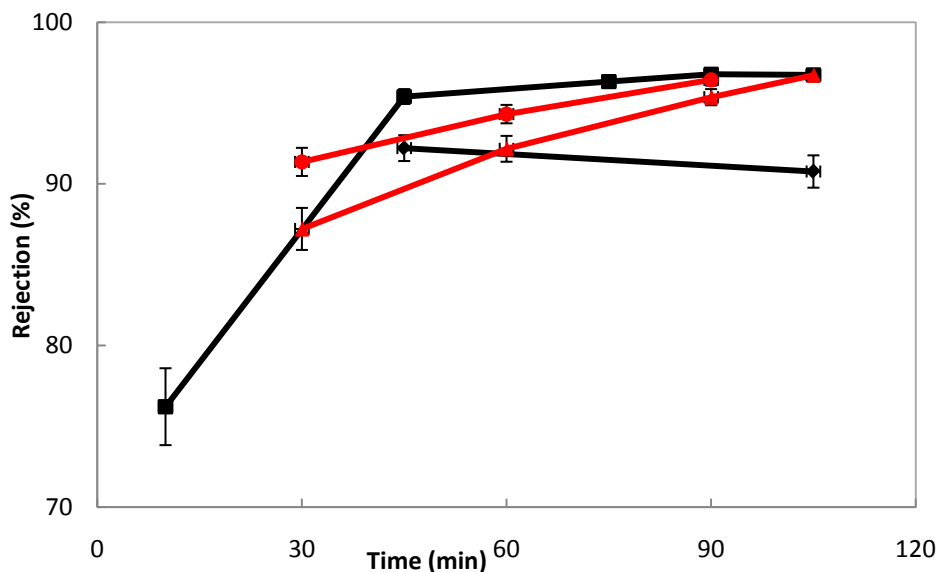

Figure 4.11 Comparison of the rejections obtained from difference feed pH during EUF of BSA at polarity $-UF+$, (\blacklozenge) Nr.6 pH 3.8 ± 0.3 , (\blacksquare) Nr.5 pH 5.4 ± 1 (\blacktriangle) Nr.2 pH 7.6 ± 0.7 (\bullet) Nr.3 pH 8.9 ± 0.2

In Exp. Nr.6, the rejection increased as compared with normal UF filtration. This is due to the fact that in the competition with TMP, electrical field in this case dragged the BSA away from the membrane surface which then decrease gel concentration on the membrane surface. However, the rejection in the case of Exp. Nr.6 also decreased slightly with time. A possible explanation could be that at acidic condition membrane and BSA have attraction interaction therefore resulted in small amount of BSA transported into permeate. It can also be due to the decrease of electrophoretic force because of slight increase of pH. In the basic conditions Exp. Nr.2 and Nr.3, the rejections turned out to be higher than that obtained with UF filtration. This was due to the enhanced transport towards membrane thereby increasing the deposition rate of BSA on membrane. The slight increase of pH resulted in gradually increase of rejections because BSA became more negatively charged. In Exp. Nr.5, the rejection first decreased slightly after applying the electrical field, which turned out to be strange. This effect may be from the dynamic effect between the pore size of membrane and BSA molecular at pI but not from electrical field since BSA was neutral. Due to the increase of feed pH after 30min, BSA became slightly negatively charged, under the influence of electrical field, electrical field imposed the effect on the transport of BSA towards membrane therefore increasing the gel layer which limited the BSA transporting through the membrane.

Variation of the current, pH and conductivity with time during the electro-transport of BSA in the 4 experiments is presented in Appendix 2.

4.3.1.3 UF Membrane fouling tendency after each experiment

The purpose of showing these results is to give the ideas about 1) whether the application of electrical field in UF filtration helps depolarize membrane surface 2) whether the feed pH has effect on membrane fouling.

In Figure 4.12, we present the fouling tendency of each experiment by looking at the water permeability before and after experiment.

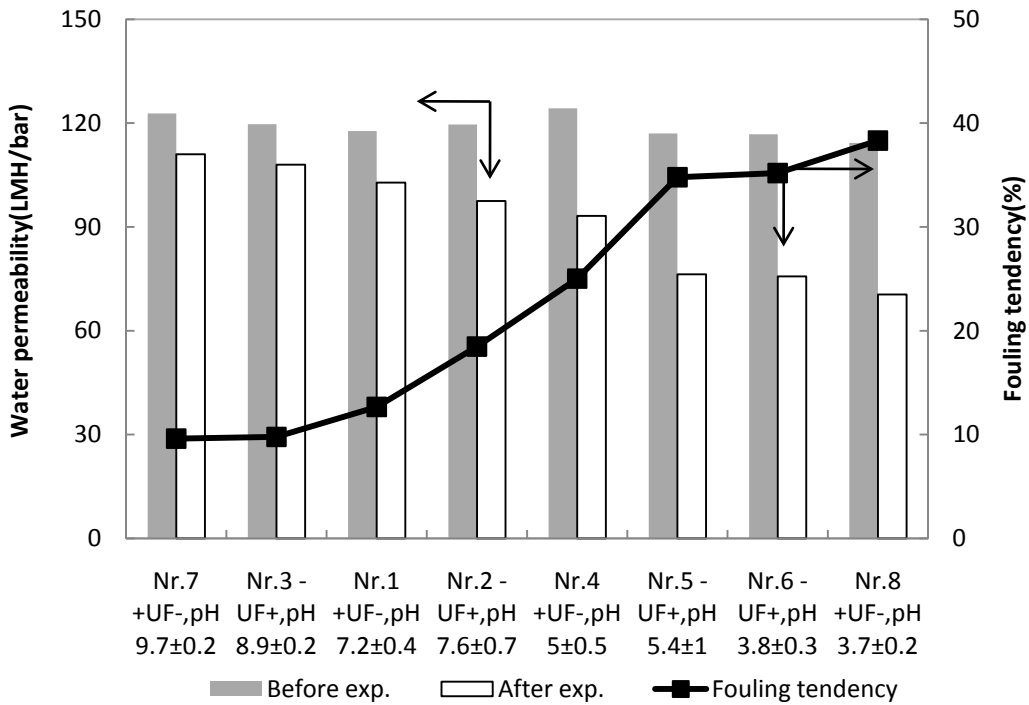

Figure 4.12 Comparison of the UF membrane fouling tendency of each experiment by comparing the water permeability before and after each experiment

We have seen that the water permeability of the membrane after caustic cleaning can be obtained at quite constant level which was around 119 ± 5 LMH. Therefore it can suggest that the cleaning method is quite robust. As the fouling tendency line shows, Exp. Nr. 4, Nr.5, Nr.6 and Nr.8 which have feed solution at acidic condition had more severe fouling problem than those having feed solution at basic. The more acidic of the feed solution, the more severe fouling it will affect on the membrane. In Exp. Nr.8, the fouling tendency was higher than Nr.6 even though both of them were operated with feed pH around 3.8. The reason why in Exp. Nr.8 fouling tendency was higher is

because in Exp.Nr.8 electrical field was applied in the direction +UF- therefore under the influence of electrical field; BSA⁺ was dragged towards membrane, which then clings to the membrane.

Operating with solution at basic condition gave lower fouling tendency. The more basic of the feed solution operated with, the less severe fouling it will affect on the membrane. Even though in Exp. Nr.1 (+UF-), electrical field was supposed to depolarize the membrane surface, it still have higher fouling tendency than in Nr.3 (-UF+). It can therefore tell that the feed pH which determines the interaction between BSA and membrane is more important than the depolarization effect from the electrical field.

4.3.1.4 Summary

We can summarize from the studies with UF membrane both in the absence and presence of electrical field:

- In normal UF filtration, pH did affect the flux and rejection. Operating with feed solution at acidic condition (lower than pH 4) gave lower flux and rejection as compared with operating with basic feed solution. Operating with solution at pH close to the pI of BSA resulted in the lowest flux. It suggests that the solution pH affects the electrostatic membrane-protein and protein-protein interactions. Lower rejection also suggests that the BSA solution has electrostatic attraction with this UF membrane.
- The rejection of the BSA can be manipulated by applying the electrical field. However, the interaction between BSA and membrane seemed also very strong especially when the BSA was negatively charged. Positively BSA⁺ has the tendency to cling on the membrane, therefore foul the membrane.
- When the scenario is BSA⁻ was electro-transported away from the membrane under the influence of electrical field, the flux increased as compared with normal UF filtration manner due to the depolarization effect.
- When the scenario is BSA⁺ was electro-transported away from the membrane surface, the flux didn't turn out to increase. This may again due to the electrostatic interaction between BSA⁺ and membrane.
- In EUF, operating with basic solution was again more sustainable in terms of keeping flux stable.

- Permeate conductivity should keep at certain level otherwise water splitting could happen therefore increasing the energy consumption.

4.3.2 Filtration with MF membrane

The experimental results from filtration of UF membrane both in normal UF filtration and EUF filtration were presented in section 4.3. Those results were very helpful when the goal is to concentrate the enzymes solution using UF membrane. If electro-membrane filtration is applied on the purpose of separating two enzymes, a bigger pore size membrane should be used. There, a microfiltration membrane was used to investigate the transport phenomena both in the absence and in the presence of electrical field.

Firstly, normal microfiltration (MF) experiments of BSA solution were carried out in order to later compare with the microfiltration operation in the presence of electrical field (EMF). We have demonstrated that the pH of feed solution has effect on the filtration performance using UF membrane; therefore MF of BSA solutions at three different pH (acidic, neutral and basic pH) was conducted in order to investigate the effect of pH on the rejection and flux. Secondly EMF of BSA solution was carried out to investigate how the electrical field affects on the transport of BSA solution at different pH i.e. BSA in different charge conditions. Both polarity of the electrical field were tested. Thirdly, another three experiments were carried out in a new MF operation manner in order to investigate if the operation manner does affect on the filtration performance in terms of BSA rejection and permeate flux. All the experiments done related in this study are presented in Materials and Methods section.

4.3.2.1 MF of BSA

The purpose of carrying experiments with MF filtration is to characterize the membrane filtration performance when operating in normal MF filtration manner. It can give ideas about how the filtration performance is as function of TMP and time at constant TMP. It can also help us to compare the results we obtained from the similar experiments operating with UF membrane. Again, rejection and permeation flux are the two parameters that we look at the filtration performance.

5 experiments described in section 4.2.3 were carried out. Details of the experimental condition can be referred to Table 4.4.

Table 4.4 Experimental conditions of MF filtration of BSA

Exp. Nr.	Feed concentration(g/L)	TMP (bar)	Feed pH	Charge of BSA	Note
1	1.05-0.91	TMP increased gradually	6.83±0.13	-	No titration with feed solution; Flux as function of TMP
2	1.01-1.03-1.19	0.6; 1.2	6,8±0.07	-	No titration with feed solution; Flux as function of time at both 0.6 and 1.2 bar for 2 hours respectively
5	0.95-1.16	0.6	3,8±0.3	+	Titration with HCl
7	0.91-1.6	0.6	9.5±0.4	-	Titration with NaOH
9	0.91-1.47	0.6	6.9±0,08	-	No titration with feed solution

4.3.2.1.1 Flux and rejection change as function of time and TMP

In order to see how the permeation flux and BSA rejection behave with respect to TMP, data from Exp. Nr.1 as Table 4.3 shows is plotted in Figure 4.13.

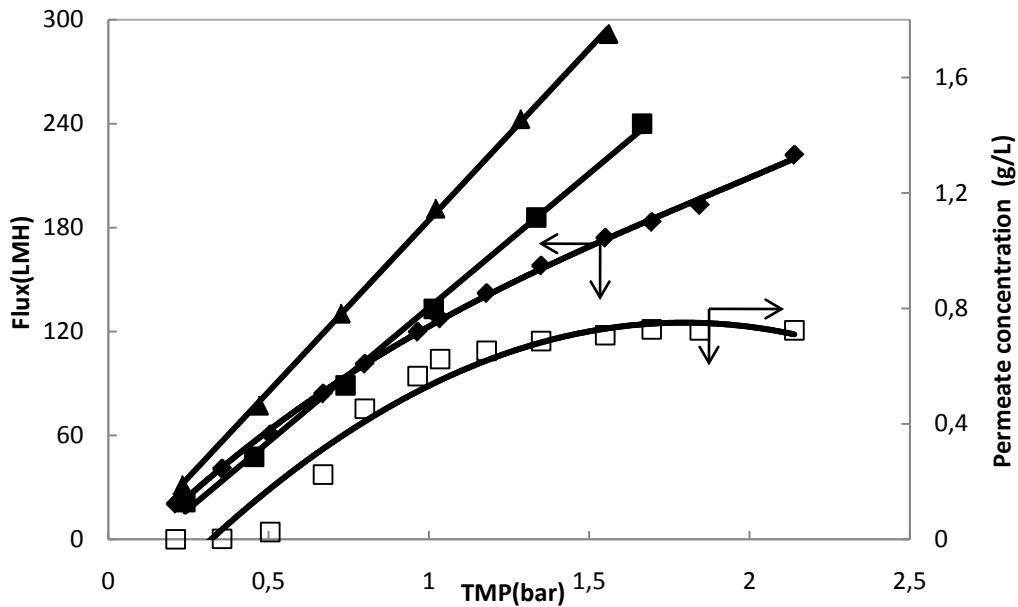

Figure 4.13 Permeation flux and permeate concentration of BSA as function of TMP during MF of BSA (Exp. Nr.1 from Table 4.3) at feed pH around 7; (■)H₂O flux after exp.(▲) H₂O flux before exp. (◆)Permeate flux during exp.(□)BSA permeate concentration

As expected, the pure water flux through the MF membrane is proportional to TMP. And the permeation flux increased with the increase of TMP, but after a finite TMP around 1bar flux didn't increase proportional to TMP. Since MF membrane has much bigger pore size than UF membrane,

the flux didn't get more bended than in the UF membrane when filtrating the same concentration of BSA solution. We could expect that with the feed concentration increasing, the curve will get more bended.

Permeate concentration of BSA also increased with the increase of TMP, as expected it didn't increase linearly with TMP. Permeate concentration of BSA started increasing gradually from 0.5bar to 1bar then began leveling off. As compared with Figure 4.2, the permeate concentration of BSA didn't increase when TMP was bigger than 1.5bar. In Figure 4.2, the rate of permeate BSA concentration became bigger with the increase of TMP, however in Figure 4.19 it became smaller and level off after 1.5bar. The difference of the change rate of C_p indicates that the MF membrane used in the studies is easier to be fouled than the UF membrane. By using different types of membrane, the variation of permeate BSA concentration can be very different due to membrane properties such as porosity, roughness, porous size and polymer properties. Due to the larger pore size of MF membrane than UF membrane, there is almost no concentration polarization. Normally, the amount of protein deposited within the membrane pores of UF membrane is smaller compared with that on the membrane surface. However, in MF there is greater deposition within the pores, and internal fouling appears to dominate with large pores [128]. This was why permeate concentration leveled off at high TMP.

Based on the results from Exp. Nr.1 (refer to Table 4.3), the rejections at 3 different selected TMP were calculated and plotted in Figure 4.14.

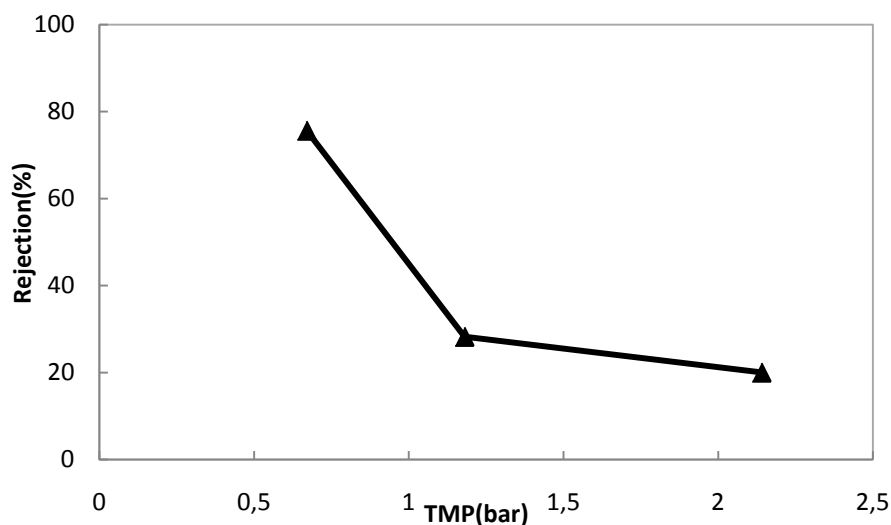

Figure 4.14 Rejection calculated at 3 selected TMP from Exp. Nr.1 during MF of BSA (Table 4.3)

From TMP 0.7 to 1.2 bar, the rejection decreased dramatically with the increase of TMP. This indicated that in the range 0.7 to 1.2bar, more and more BSA was transported through the membrane with the increase of TMP. After 1.2bar, rejection didn't decrease so much with the increase of TMP suggesting that the transport has reached to a steady state. It is common that in MF filtration, the rejection will increase due to the severe fouling taking place inside of the membrane [128], the reason why this phenomenon did not happen was due to that at pH around 7, the membrane and BSA have the same charge which counterbalanced the fouling effect.

Two constant TMPs (0.6 and 1.2 bar) were chosen to investigate the flux and transmission as function of time. Another reason to carry out this experiment was to characterize the membrane performance in a relative lower TMP (here 0.6 bar) and a higher TMP (here 1.2bar). Experimental details can be referred to Exp. Nr. 2 from Table 4.3.

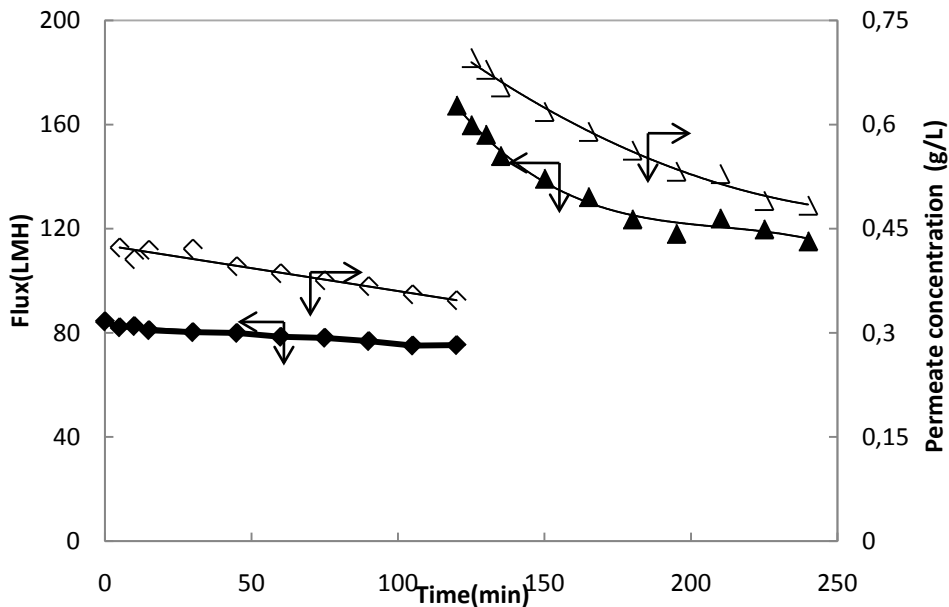

Figure 4.15 Permeate flux and concentration change as function of time at two constant TMPs during MF of BSA, (◆)Flux at 0.6bar(▲)Flux at 1.15bar(◇)BSA permeate concentration at 0.6bar(△) BSA permeate concentration at 1.15bar

The experiment was first operated at constant TMP 0.6 bar for 2 hours, then TMP was increased to 1.15 bar and run for another 2 hours. Let's first look at the permeate flux change at the two constant TMPs. At lower TMP 0.6 bar, flux stayed quite stable, it decreased by less than 10% from the start to end. When TMP was increased to 1.15 bar, flux decreased 31% during 2 hours operation. We can see that by increasing TMP, we did see the increase of flux, however the flux decreased quite lot at

TMP 1.15 bar. Therefore, it is not sustainable and energy wise to run MF filtration at higher TMP. Similar observation was also seen in the relation between permeate concentration of BSA (C_p) and experimental running time. At TMP 0.6bar C_p decreased around 18% during the experiment, by increasing the TMP to 1.2bar, C_p decreased around 30.5%. If we want to see the precise comparison between the permeate flux and C_p change at low TMP and high TMP, the two experiments should be run separately. However, here we can at least get idea that in MF filtration, running at high TMP is not sustainable in terms of keeping stable flux and permeation.

We then also compare the rejections during the experiment at these two TMPs. The results are presented in Figure 4.16

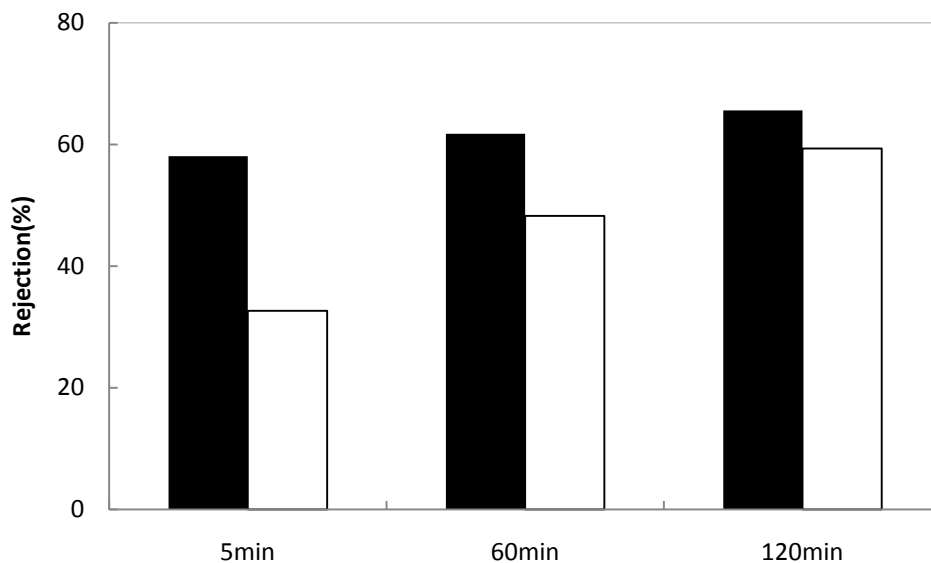

Figure 4.16 Comparison of the rejections obtained from two constant TMPs during MF of BSA
(■)0.6 bar(□)1.15bar

Due to the second layer build-up by BSA and fouling, the rejection at TMP 0.6 bar during 2 hours experiment increased slightly. By doubling the TMP to 1.15bar, rejection decreased from around 60% at TMP 0.6bar to 30% as expected, and then it increased to around 60% at the end of experiment. The increase rate of rejection increase was more evident at high TMP. Those observations proved that operating with higher TMP, the MF membrane was more easily fouled by the BSA solution. Membrane rejection increases with the increase of membrane fouling and appears to remain constant only at low pressures.

4.3.2.1.2 Effect of solution pH on flux and rejection

In UF section, we have seen that the pH of feed solution has effect on the filtration in terms of permeate flux and rejection. We expect that similar observation should happen as well to MF filtration. 3 experiments (see Table 4.3) running with different feed pH were conducted in order to investigate the effect of feed pH on the BSA transport. Because the pore size of MF membrane is much bigger than the size of BSA, it is expected that more BSA will be transported into permeate. Since those three experiments were operated with the new operation manner, which means that the measured permeate concentration should be converted into the real permeate concentration based on mass balance. All the data of measured permeate concentration and calculated permeate concentration were plotted in the Figures and are presented in Appendix 3.

The permeation flux of these three experiments was compared in Figure 4.17.

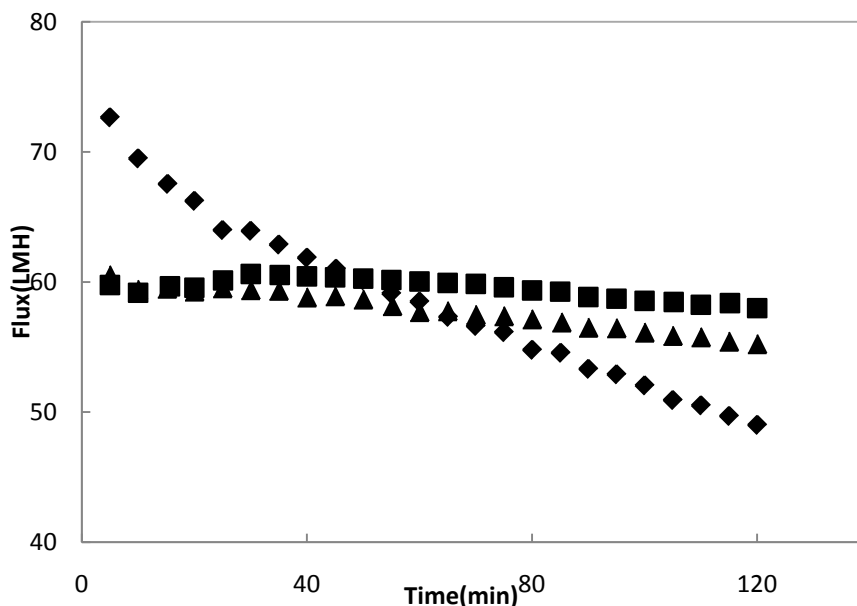

Figure 4.17 Comparison of the permeate flux obtained at different feed pH during MF filtration of BSA (◆)Nr.5,pH 3.8 ± 0.3 (▲)Nr.9,pH 6.9 ± 0.08 (■)Nr.7,pH 9.5 ± 0.4

A quite stable flux was observed during the experiment running with solution pH basic as in the case of Exp. Nr. 7. The stable flux can be due to the similar charge of membrane and BSA at basic pH. The flux in the acidic condition (Exp. Nr.5) at first 30min was highest and it decreased greatly during the experiment. A possible explanation of this observation can be that there is attraction interaction between membrane and BSA at acidic pH, at the beginning of experiment this interaction resulted in higher flux because of larger pore size compared to the size of BSA ,

however due to the internal fouling and pore constriction the flux decreased with the time. The highest flux observed in exp. Nr.5 at the beginning of the experiment can also due to electroosmosis phenomenon, where the positively charged BSA transported through negatively charged membrane thereby resulted in enhance solvent flux.

In the neutral condition as in Exp. Nr.7, flux decreased slightly with the time due to the less repulsion between membrane and BSA in comparison to basic condition.

If we look at the permeate concentration of BSA together with the permeation flux (as volume flux), we can see that the solute flux in exp.Nr.5 was also higher than that in exp. Nr. 7. In Figure 7.7 (see Appendix 3), it has also been found that variation of permeate concentration was also dependent on the pH which resulted in the interaction between membrane and BSA. Permeate concentration of BSA was also found the highest at acidic acid which we guess was due to the electrostatic attraction between membrane and BSA. While in the cases (Exp. Nr.9 and Nr.7) when BSA and membrane have similar charge, lower permeate concentration was observed.

In order to better look at how much BSA was transported into permeate solution, solute flux (product of volume flux and permeate concentration of BSA) was calculated in each experiments at 15 and 115 minutes respectively and was compared in Figure 4.18.

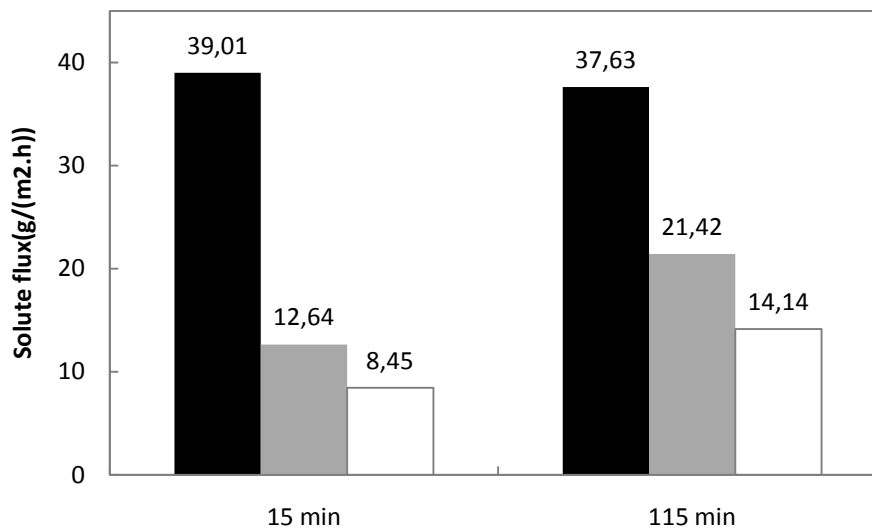

Figure 4.18. Comparison of the solute flux obtained at different feed pHs during MF of BSA, (■) Nr.5, pH 3.8±0.3 (■) Nr.9, pH 6.9±0.08 (□) Nr.7, pH 9.5±0.4

It can be seen that with the pH increasing from acidic to basic, the solute flux decreased, especially when the charge of BSA was changed from positive to negative. Solute flux in acidic condition didn't change too much during the experiment as seen in 15 and 115mins, however, it almost doubled at pH neutral and basic. The decrease of the solute flux at pH solution neutral and basic probably was due to the electrostatic repulsion effect between the membrane and BSA was weakened. The electrostatic repulsion at basic pH was stronger than that in neutral pH because BSA was more negatively charged at basic pH. This is why the lowest solute flux was seen in exp. Nr.7. Since the establishment of a stronger electrostatic repulsion at basic pH, the volume flux of exp. Nr.7 in Figure 4.17 was much better maintained.

Another parameter that is interesting to look at is the membrane rejection of BSA. Rejections of the three experiments were calculated at five time points and were compared in Figure 4.19.

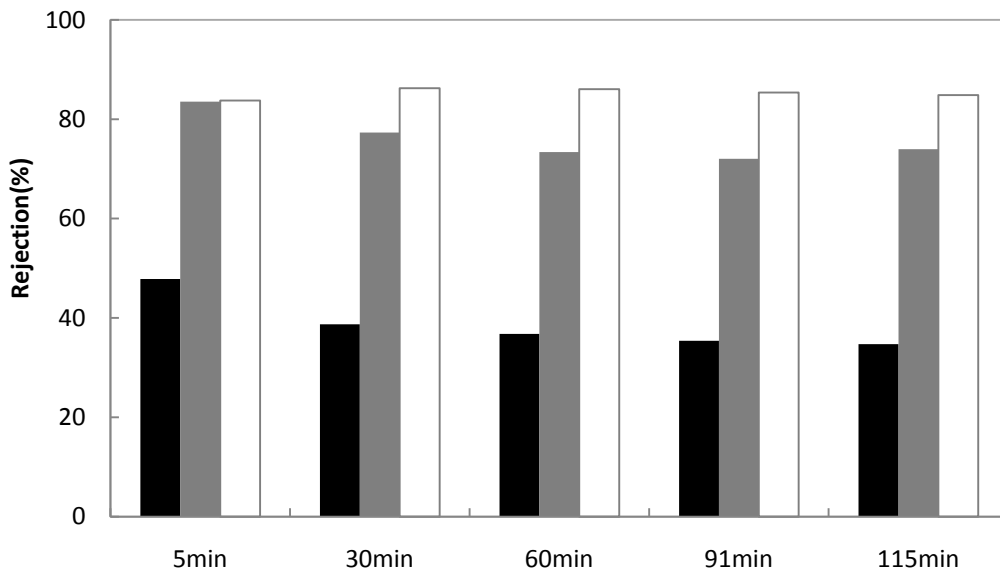

Figure 4.19 Comparison of BSA rejections obtained at different feed pHs during MF of BSA (■) Nr.5,pH 3.8±0.3(■)Nr.9,pH 6.9±0.08 (□) Nr.7,pH 9.5±0.4

It can be clearly seen that the rejection obtained in Exp. Nr.5 was lowest, nearly half of that in Exp. Nr. 9 and Nr.7. This is again due to the fact the electrostatic attraction between membrane and positively charged BSA in acidic condition. Because BSA was negatively charged both in Exp. Nr.9 and Nr.7, the existence of electrostatic repulsion between the membrane and BSA therefore caused the rejection higher than that in the case of Exp. Nr.5. Another interesting observation seen in Figure 4.19 was that when BSA was more negatively charged in basic condition than in neutral condition, besides a higher rejection was obtained, a more stable rejection was observed.

It can be concluded that all the observations found in terms of BSA transport, permeate flux and rejection were dependent on solution pH, which can be explained by the electrostatic effects (repulsion or attraction) between the membrane and BSA. Based on all the results we discussed in the three experiments, we are sure that the membrane has negatively charged properties over the investigated range of pH (due to no access to zeta potential measurement at the time of those experiments were done, membrane was later measured in Novozymes). Even though permeate flux decreased rapidly with the time at acidic condition, the transmission and solute flux were the highest over the investigated pH range.

4.3.2.1.3 Effect of MF operation manner without permeate circulation on flux and rejection

As mentioned in Materials and Methods section, there are two ways of operating the MF filtration in our system, dependent on whether there was initial permeate solution in the permeate reservoir at the start. Normal operation with MF filtration is run without any initial permeate solution in the permeate reservoir. The three experiments with the new operation manner (where there was 300ml Na₂SO₄ in the permeate reservoir as initial permeate solution) were tried and the results were discussed in section 4.3.2.1.2. It is interesting to see if the operation manner does have the effect on BSA transport with exact same running conditions. Therefore, three experiments with similar experimental conditions but different operation manner were carried out. The experiments were conducted without any initial permeate solution being fed into the reservoir, therefore no permeate solution in the reservoir was circulated by the pump because the permeate pump was not used at all. The permeate solution was collected directly from the outlet of permeate tube. The concentration measured from this collected solution was considered as permeate concentration of BSA (as comparable with the calculated permeate concentration in section 4.3.2.1.2), which is used to calculate the rejection. The experimental conditions were shown in Table 4.5.

Table 4.5 Experimental conditions of MF of BSA in normal MF filtration manner (without permeate circulation)

Exp. Nr.	Feed concn.(g/L)	TMP	Feed pH	Charge of BSA
A	0.92-0.95	0.6bar 50min; 1.2bar 50min	3.6±0.9	+
B	0,93-0,99	0.6bar 50min; 1.2bar 50min	6.8±0.3	-
C	0.93-0.99	0.6bar 50min; 1.2bar 50min	9.8±0.2	-

As compared with the three experiments (Exp. Nr.5,Nr.7 and Nr.10) carried out in Table 4.3, similar three experiments operated in normal filtration manner were carried out with 3 different feed pH , i.e. neutral, acidic and basic. Besides different operation manner applied, each experiment was done at two different TMP (0.6 bar and 1.2bar). It started with lower TMP for 50min and then continued with higher TMP for another 50min.

Both permeation flux and BSA permeate concentration in each experiment were measured and shown in Figure 4.20.

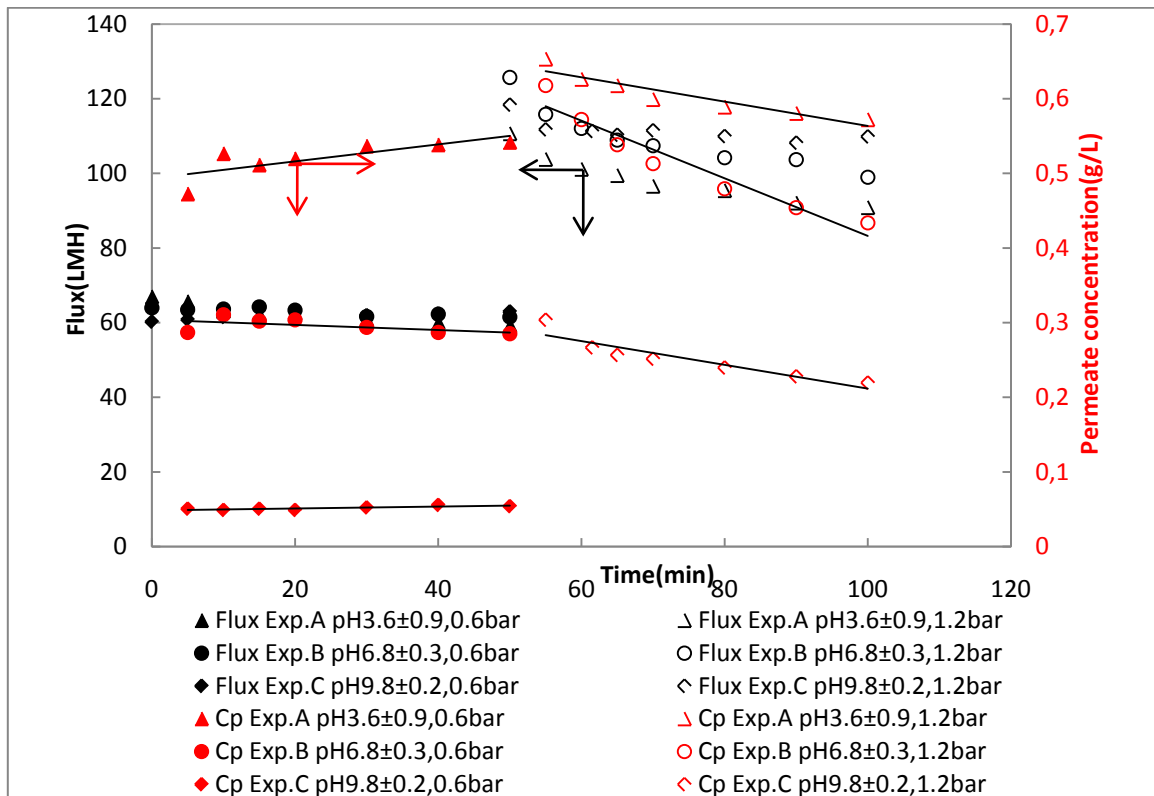

Figure 4.20 Comparison of the permeate flux and permeate concentration of BSA obtained from different feed pH at two constant TMPs during MF of BSA operated without permeate circulation (right Y axis is for flux, left Y axis for BSA permeate concentration)

As shown in Figure 4.20, the permeate flux was quite stable when operating at lower TMP and it decreased in all the experiments when operating at higher TMP. The flux decreased by 17.9%, 21.3%, and 7% when operating at higher TMP in Exp. A, B and C respectively. It seemed that feed solution without titration with acid or base was not favored in terms of sustainable flux especially at higher TMP.

When it comes to the change of permeate BSA concentration, different observations were identified between lower and higher TMP. When operating at lower TMP, the permeate BSA concentration increased slightly in Exp.A where the pH of feed solution was acidic. In Exp. B and C the permeate BSA concentration stayed quite stable. By operating at higher TMP, the permeate BSA concentration increased quite a lot at the beginning especially in Exp. B and C. Then it decreased with the time in all the cases.

It seemed that at lower TMP, the transport was mainly governed by the electrostatic effect especially in the case when BSA was positively charged. While at higher TMP, it was mainly governed by the TMP which is responsible for permeation flux. The membrane fouling became worse when operating at higher TMP which can be reflected both from the permeation flux and permeate BSA concentration.

As compared to Figure 7.7 (Appendix 3) and 4.17, where the permeate BSA concentration and permeation flux were shown when operating with new MF manner (initial permeate solution was circulated by permeate pump), some differences can be identified and showed interesting. The BSA permeate concentration at 50min in Figure 4.20 was little bit lower than that shown in Figure 7.7. This is due to the fact that when operating with permeate solution circulating, diffusion transport caused by the concentration difference between feed and permeate compartment was bigger than the case without permeate circulating. However in our case, because the bulk concentration in all the experiments was low, the difference of BSA transport was not significant. The permeation flux between the two different operation manners was similar except in the case when feed pH was in acidic condition. We don't why this was the case; maybe it was because the membrane in acidic condition was more open when operating with permeate circulation due to the clean-up effect at the back of membrane.

Rejections at different time point were calculated both in the case of lower TMP and higher TMP. The rejections at lower TMP obtained from the 3 experiment are presented in Figure 4.21 and rejections from higher TMP are presented in Figure 4.22.

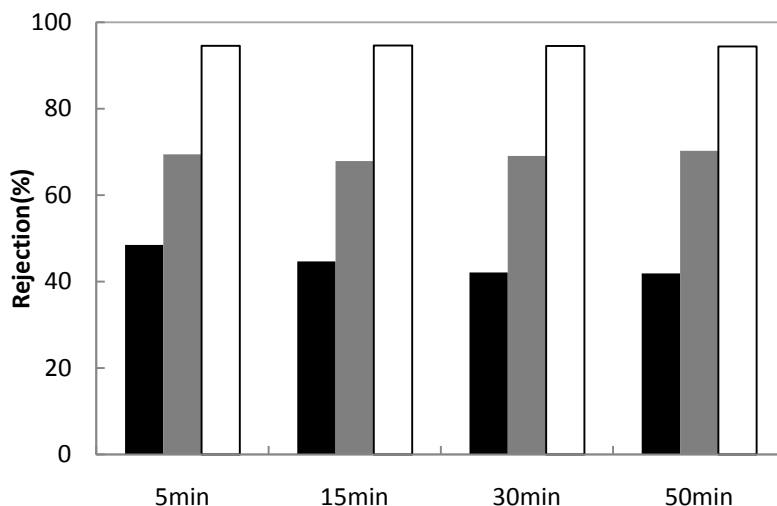

Figure 4.21 Comparison of rejections obtained at different feed pHs, constant TMP 0.6 bar during MF of BSA operated without permeate circulation (■) Exp.A, pH 3.6±0.9 (■) Exp.B, pH 6.8±0.3 (□) Exp.C, pH 9.8±0.2

It can be seen in Figure 4.21 that the highest rejection was seen from Exp.C where the feed solution was basic, and the lowest rejection was seen from Exp.A where the feed solution was acidic. These observations were in accordance with that shown in Figure 4.19. It again indicated that at basic condition, the negatively charged BSA has repulsion effect from the membrane, while at acidic condition; the positively charged BSA has attraction effect from the membrane. The rejection of Exp.B and C turned out to be quite constant, while the rejection of Exp. A decreased slightly by 14% at 50min as compared to that at 5min. This indicated that the membrane did not have fouling problem within the operation time.

In comparison with the rejections obtained when operating with circulating permeate solution, the rejections in Figure 4.21 turned out to be more stable even though it's not significant. And at basic condition of feed solution, the rejections turned out to be higher in Figure 4.21 than that in Figure 4.19 due to the less diffusion transport. While the rejections at neutral condition of feed solution were lower in Figure 4.21. The reason why rejections were lower when the pH of feed solution was neutral in the case of no circulation of permeate solution might be due to the membrane structure has something to do with the acid or base. It can be concluded that when the feed solution was titrated with either acid or base, by operating with circulating permeate solution helped decrease the rejection. Therefore if the scenario is when solute is wanted to be transported into permeate

compartment, operation of MF with permeate solution circulating is desired at least at low TMP we have studied.

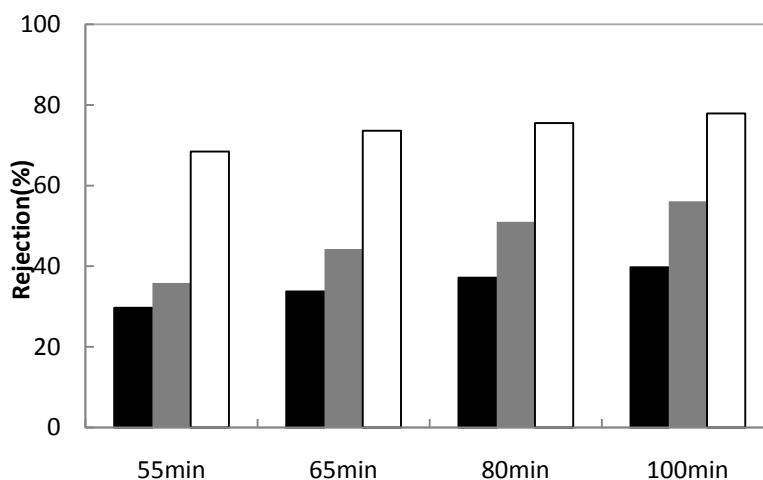

Figure 4.22 Comparison of rejections obtained at different feed pHs, constant TMP 1.2 bar during MF of BSA operated without permeate circulation (■) Exp.A, pH 3.6±0.9 (■) Exp.B, pH 6.8±0.3 (□) Exp.C, pH 9.8±0.2

In Figure 4.22, the rejections obtained at higher TMP 1.2bar from the 3 experiments are presented. Again, the highest rejection was seen from Exp.C and lowest seen from Exp. A. Compared to the rejections shown in Figure 4.21, the rejections in Figure 4.22 decreased nearly 30%, which was obvious due to the increase of TMP. Interesting observation which was not shown in Figure 4.21 was that the rejection in all the experiments turned out to increase with time. This indicated that MF membrane fouling was easier to take place when operating at higher TMP. The rejections increased by 34%, 57% and 14% from 55min to 100min in Exp.A, B and C respectively. Even though, there was electrical attraction effect between the membrane and positively charged BSA in Exp. A, the rejection still increased as Figure 4.22 showed. This means that at higher TMP, attraction effect could not help counterbalance fouling effect caused by the pressure. Another interesting observation found in Figure 4.22 was that the highest percentage increase of rejection was seen in Exp. B even though BSA was negatively charged. We guess that this probably was due to the lowest conductivity in Exp.B which affected the BSA solubility and membrane structure.

As conclusion, we can say that the pH of feed solution again has big effect on the rejection and almost no effect on the flux at lower TMP. Operating at higher TMP caused membrane fouled especially at the condition of neutral feed pH.

The operation manner did affect the BSA transport and permeation flux change due to the difference of diffusion transport caused by the operation. The rejection obtained when operating without permeate solution circulation was higher than when operating with permeate solution circulation in the case of basic and acidic (not significant in acidic). This was due to the fact that when operating with permeate solution circulating, diffusion transport caused by the concentration difference between feed and permeate compartment was more intensive than the case without permeate circulating.

4.3.2.2 EMF of BSA

By applying the electrical field, the charged solute will migrate towards to its specific electrode polarity. Therefore the pH of feed solution which determines the charge condition of BSA and the electrode polarity are very important. The purpose of carrying out experiments in the presence of electrical field is to find out how much effect of electrical field on filtration performance with respect to feed pH and polarity. Furthermore, we have shown the results using UF membrane in the presence of electrical field in section 4.3.1.2, and have demonstrated that by applying the electrical field, the permeation flux increased when the solute was taken away from the membrane surface. Therefore, it will be interesting to see how the solute transports in a more open membrane i.e. MF membrane. All the experiments listed in Table 4.6 were operated with new operation manner.

Table 4.6 Experimental conditions of EMF filtration of BSA

Exp. Nr.	Feed concentration(g/L)	TMP (bar)	Electric field strength (V/m)	Feed pH	Charge of BSA	Polarity	Note
3	0.98-1.1	0.6	909	4.7±1.2	+0/-	-MF+	909V/m applied after 15min of normal MF; Permeate titration with Na ₂ SO ₄ from 45min to 115min
4	0.93-0.7	0.6	909	3.2±0.5	+	+MF-	909V/m applied after 15min of normal MF; Permeate titration with Na ₂ SO ₄ when conductivity was lower than 1ms/cm

6	0.93-1.11	0.6	909	9.5±0.4	-	-MF+	909V/m applied at the start
8	0.92-1.6	0.6	909	7±3.1(10-3.9)	-/0/+	+MF-	909V/m applied at the start

The reason to begin with MF filtration in Exp. 3 and 4 at the first 15 min was easier to investigate the effect from applying the electrical field. Due to the pH fluctuation in feed compartment, the charge of BSA changed according to the feed pH, it might experience from being charged to neutral.

4.3.2.2.1 Effects of electric field and feed pH on flux and rejection

4.3.2.2.1.1 At polarity +MF-

Two experiments were carried out at polarity +MF-. Experiment Nr.4 was carried out in the condition of acidic pH of feed solution, and experiment Nr.8 was started with basic pH of feed solution. Since the new operation manner was employed, the measured BSA permeate concentration should not be consider as the real BSA permeate concentration, the measured bulk concentration should be calculated into real permeate concentration based on mass balance equation. In Figure 4.23, the measured permeate BSA concentration and calculated permeate BSA concentration from Exp. Nr.4 and Nr.8 were compared. In addition, the feed pH during the experiments was recorded.

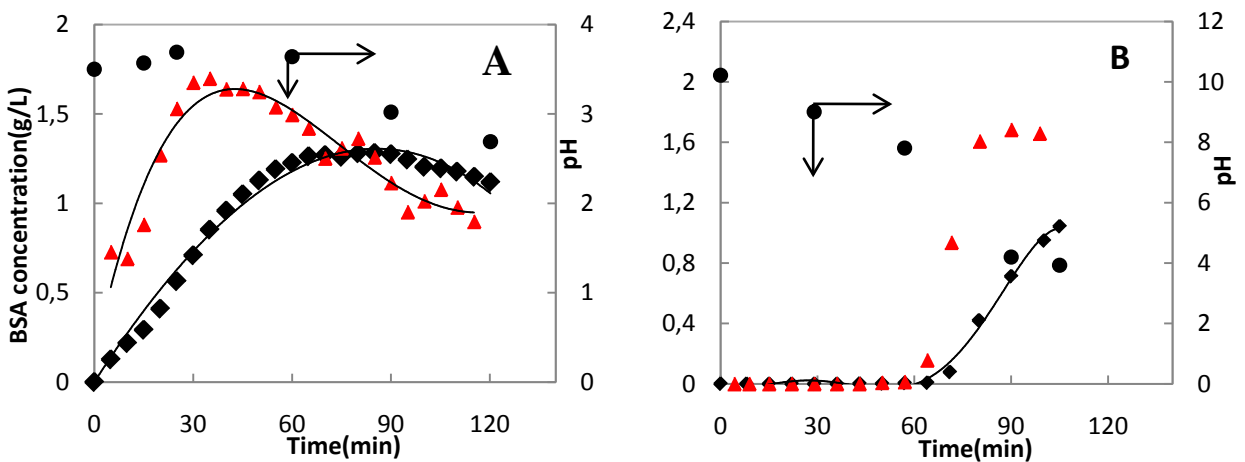

Figure 4.23 Comparison of the measured and calculated permeate BSA concentration obtained at different feed pHs during EMF of BSA at polarity +MF- (A) Exp. Nr.4 acidic pH 3.19±0.5 (B) Exp. Nr.8 basic pH 7±3.1 (details refer to Table 4.5) (◆)Cp.bulk measured(▲)Cp.calculated(●)Feed solution pH

Since BSA was positively charged in exp. Nr.4, it can be expected that the transport of BSA into permeate compartment shall be enhanced due to the electrical field dragging BSA through the membrane. It can be seen in Figure 4.23(A), during the first 15min of MF filtration, the calculated permeate BSA concentration (red triangle) stayed around 0.6 g/L, which was more or less the same as it showed in Figure 7.7 (A) (Appendix 3) where no electrical field was applied. By applying the electrical field in the direction +MF- after 15min, a dramatic increase of the calculated permeate BSA concentration was observed, it reached to max. 1.7 g/L at around 35min, the increase can be explained by the extended Nernst Plank equation described in the theory section. After 35min the calculated permeate BSA concentration started decreasing to be equal with the measured permeate BSA concentration (black triangle) at around 60min. When operating at polarity +MF-, the permeate solution in the compartment will be depleted. In the amino acid section, we have discussed that the conductivity of permeate solution should be kept at certain level otherwise water splitting on the cation-exchange membrane will take place in order to maintain current transfer and balance the neutralization in the whole system. When the permeate conductivity was lower than 1ms/cm, dosage of Na₂SO₄ into permeate compartment was executed. The consequence of the addition of Na₂SO₄ was that the resulting current increased which eventually resulted into the enhancement of the transport of BSA as you can see in the Figure after 65 and 90 min where the dosage was performed. This confirmed that the increase of current will eventually help increase the transport of BSA which is exactly how the extended Nernst plank equation described. The calculated permeate BSA concentration started decreasing at around 35min, which can be explained by two factors: firstly, according to Figure 4.1, the charge of BSA (equivalent to zeta-potential) in acidic range does not increase with the decrease of pH, as Figure 4.1 shows that when the solution pH is lower than 3.8, zeta potential starts decreasing, and in this case the pH started decreasing from 35min (due to electrolytic reaction resulting in releasing hydrogen ion) which resulted in the decrease of BSA charge; secondly, the conductivity of the whole system decreased due to the salt depletion in permeate compartment which eventually resulted in the decrease of current efficiency thereby the electrophoretic driving force for BSA transport might also decrease.

In Exp. Nr.8, basic pH of feed solution was tried at polarity +MF- in order to see whether opposite effect can be seen. In Exp. Nr.4 we have seen that the mass transport rate was enhanced due to the presence of electrical field which constitutes an additional driving force. By changing the BSA charge form, an opposite situation of mass transport can be expected. It was very encouraging that the mass transport of BSA was almost zero at the first 1 hour as can be seen in Figure 4.23(B). This

proved that the by applying the electrical field in the direction of pulling BSA away from membrane, the mass transport of BSA into permeate can be controlled. After 1 hour, a sudden increase of the calculated permeate BSA concentration was found, this was due to the fact that the pH of feed solution started becoming acidic which caused BSA charge change into positively charged. The reason why pH changed was because that the conductivity in permeate compartment from 1 hour was lower than 0.5ms/cm; therefore water splitting and electrolytic reaction happened in order to generate more ions to carry out the current.

The permeation flux from Exp. Nr.4 and Nr.8 was measured during the experiments and was compared to the permeation flux from Exp. Nr.5 and Nr.7 (refer to Table 4.3), where no electric field was applied. The comparison of permeation flux among the four experiments is shown in Figure 4.24.

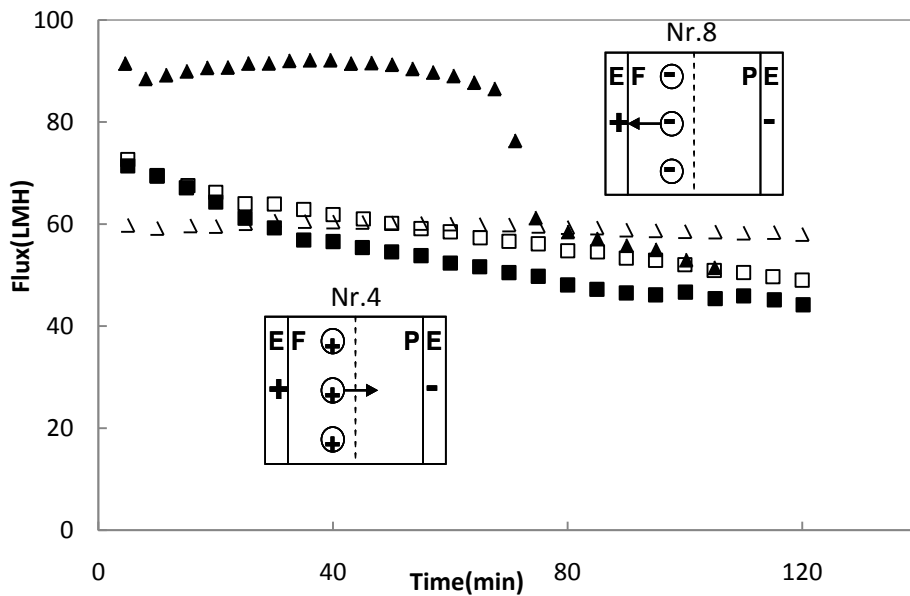

Figure 4.24 Comparison of the permeate flux obtained at different feed pH during MF and EMF of BSA at polarity+MF- of BSA (■)EMF Nr.4, pH 3.2±0.5(□) MF Nr.5,pH 3.8±0.3(▲)EMF Nr.8,pH 7±3.1 (Δ)MF Nr.7,pH 9.5±0.4 (details on experimental condition for Exp. Nr.5 and Nr.7 can be referred to Table 4.3)

In the first 15min when no electric field was present, the permeation fluxes from Exp. Nr.4 and Nr.5 were the same, which was in accordance with our expectation because the experimental conditions were the same. When applying the electric field in Exp. Nr. 4, a decrease of permeation flux as

compared to that from Exp. Nr.5 was discovered. This consequence can be explained by the fact that in the presence of electric field with the direction of dragging BSA towards membrane surface, more BSA would cling on the membrane which eventually caused more severe membrane fouling in comparison with the case when no electric field was applied. Surprisingly, the membrane fouling caused by the additional force from electric field dragging BSA towards membrane was not so great. This is probably due to the low bulk concentration used in our studies.

When the electric field was applied with the direction of dragging the negatively charged BSA away from membrane surface such as in the case of Exp. Nr.8, the permeation flux was enhanced nearly 50% in comparison with that from Exp. Nr.7. This consequence was due to that the deposition of BSA on the membrane was reduced by the electric field thereby the flux increases. However, in order to keep the permeation flux sustainably stable, the pH of the feed solution should be kept at basic level. The reason why a decrease of flux was seen in Exp. Nr.8 after 65min was due to the change of feed pH into acidic which resulted in the charge of BSA into positive. Similar results were reported by Wakeman *et. al* that the permeate flux was enhanced by up to an order of magnitude during electrophoretically assisted crossflow microfiltration of albumin suspension at electric field strength 3330V/m TMP nearly 2bar when BSA was taken away from membrane and BSA rejection was similarly increased [100,131].

Permeation flux is a parameter to characterize the membrane whether it has fouling or not, rejection is usually considered as a parameter to look at how the membrane functions with regard concentration or fractionation. Figure 4.25 shows the BSA rejection calculated from Exp. Nr.4, Nr.5, Nr.8 and Nr.7. The purpose is also to show whether the presence of electric field has effect on the BSA transmission or rejection.

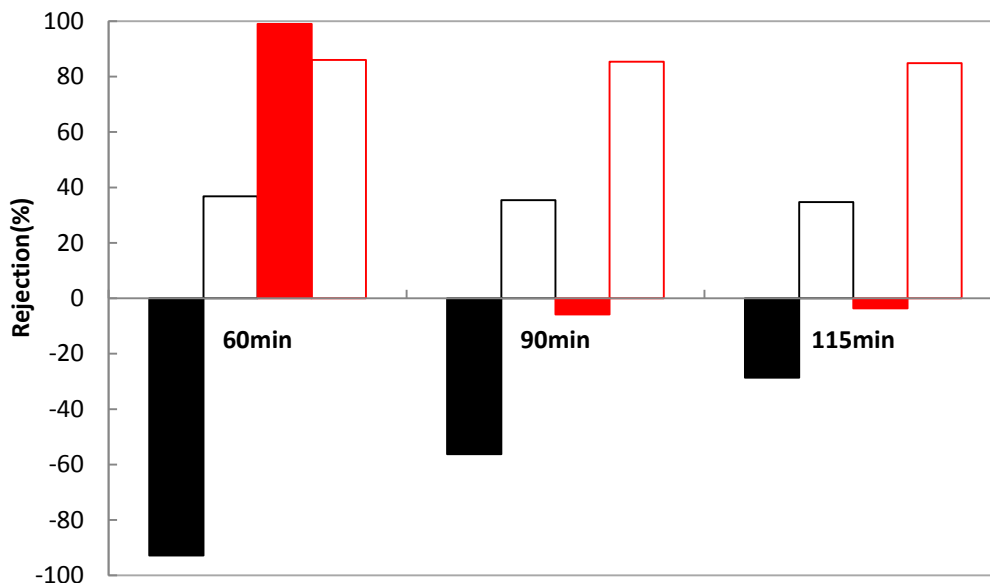

Figure 4.25 Comparison of BSA rejections obtained at different feed pH during MF and EMF of BSA at polarity+MF-, (■)EMF Nr.4, pH 3.2 ± 0.5 (□) MF Nr.5, pH 3.8 ± 0.3 (■)EMF Nr.8, pH 7 ± 3.1 (□)MF Nr.7, pH 9.5 ± 0.4 (details on experimental condition for Exp. Nr.5 and Nr.7 can be referred to Table 4.3)

Both Exp. Nr.4 and Nr.5 were operated with feed solution at pH lower than pI i.e. BSA in both cases was positively charged with and without electric field. Likewise, Exp. Nr.8 and Nr.7 were operated with feed solution higher than pI i.e. BSA negatively charged with and without electric field. By comparing the results from those two groups, the effects of electric field can be identified.

It can be clearly seen that by applying electric field, nearly a 3-fold decrease of rejection was observed in Exp. Nr.4., the transmission of BSA was nearly 200%. The rejection from Exp. Nr.5 stayed constantly at around 40%. Due to the electrophoretic force taking the BSA away from the membrane, the rejection in Exp. 8 reached to nearly 100%, which was enhanced 1.2-fold as compared to that obtained at MF filtration. Then due to the fact that the charge of BSA changed from negative into positive caused by the pH change, the rejections from Exp. Nr. 8 decreased rapidly below zero. By comparing the rejections between Exp. Nr.4 and Nr.5, it can be easily concluded that electric field imposes the electrophoretic force on the positively charged BSA which exerts an additional force dragging the BSA towards membrane thereby enhances the mass transport. Similarly, when the BSA was positively charged, the electrophoretic force exerts the force dragging the BSA away from membrane thereby reduces the mass transport.

The resulting current was recorded both in Exp.Nr.4 and Nr.8, which was presented in Appendix 4. The resulting currents from Exp.Nr.4 and Nr.8 were in different change pattern. It seemed that how the solute is transported and titration in the feed can make the current change in different way.

4.3.2.2.1.2 At polarity $-MF+$

In this section, two experiments were carried out at polarity $-MF+$ at constant TMP 0.6 bar. Exp. Nr.3 and Exp. Nr.6 were carried out with feed solution at acidic and basic condition at the start respectively. In addition, Exp. Nr.3 was started operating with normal MF filtration for 15min and then continued with EMF. The experiment Exp. Nr. 6 was carried out with feed solution at basic and started directly with EMF. Details of the experimental condition can be referred to Table 4.5.

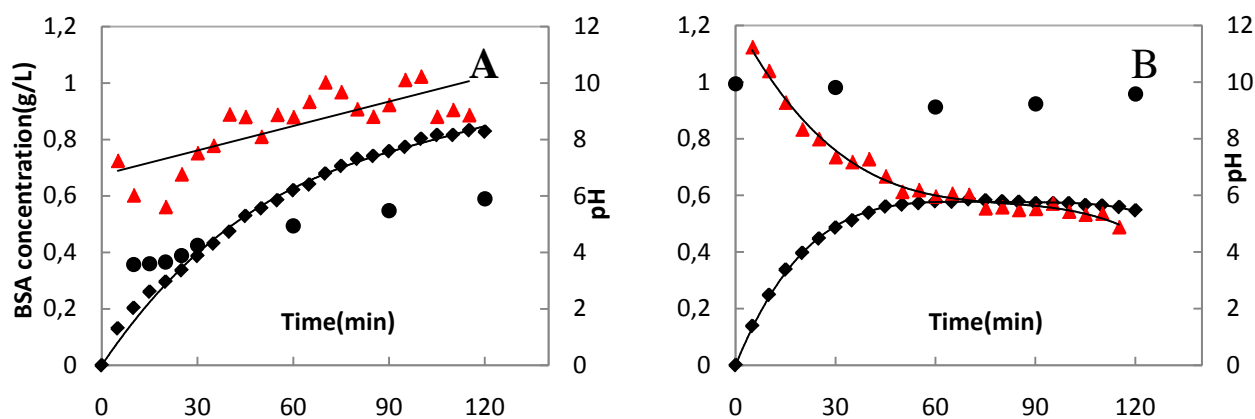

Figure 4.26 Comparison of the measured and calculated permeate BSA concentration obtained at different feed pHs during EMF filtration of BSA at polarity $-MF+$, (A) Exp. Nr.3 acidic pH 4.7 ± 1.2 (B) Exp.Nr.6 basic pH 9.5 ± 0.4 (details refer to Table 4.5) (\blacklozenge)Cp.bulk measured(\blacktriangle)Cp calculated(\bullet)Feed solution pH

When BSA is positively charged, it is expected that the transport of BSA into permeate compartment should be reduced in the presence of electric field with polarity direction $-MF+$. In Figure 4.26 (A), at the very beginning of EMF, the calculated permeate BSA concentration was lower than that operated without electric field. It started increasing to the maximum at around 45 min, after that we started dosing 2ml 1.25M Na_2SO_4 every 5 min when sample was take out, this is why fluctuation of mass transport was discovered. The pH of feed solution was not controlled in Exp. Nr.3, it increased during the experiment and became higher than the pI of BSA from 45min. Surprisingly, the mass transport of BSA was not reduced even though the electrophoretic force was to drag BSA away from membrane. This consequence probably can be explained by the fact that the

electrostatic attraction force between membrane and BSA exists and in addition convection transport was in direct competition with electrophoretic force. The fact that feed pH underwent from pH lower than 4 at start to pH close to 6 at the end was the cause of fluctuation in mass transport. In short, the reasons why electrophoretic force didn't have effect reducing the mass transport were due to the follows: firstly, the resulting current was not high thereby low electric field strength which was not strong enough to compete with the electrostatic attraction and convective transport, secondly, the pH of feed solution was not stable during experiment.

In Exp. Nr.6 where the data are shown in Figure 4.26(B) the calculated permeate BSA concentration was higher than the feed bulk concentration at start and then decreased with the time, and it reached to a plateau after 60min. Obviously, at the start the electrophoretic force dragging the negatively charged BSA towards membrane was evident. Again due to low resulting current, the electrophoretic force towards membrane surface was counterbalanced by electrostatic repulsion between membrane and BSA, which eventually resulted in the decrease of permeate concentration. After 60min, it seemed that the steady state has been reached because the measured BSA permeate bulk concentration was equal to the calculated BSA permeate concentration.

The permeation flux from the three experiments were measured and then compared with that from Exp. Nr.5 and Nr.7 which no electric field was applied. All the data are shown in Figure 4.27 below.

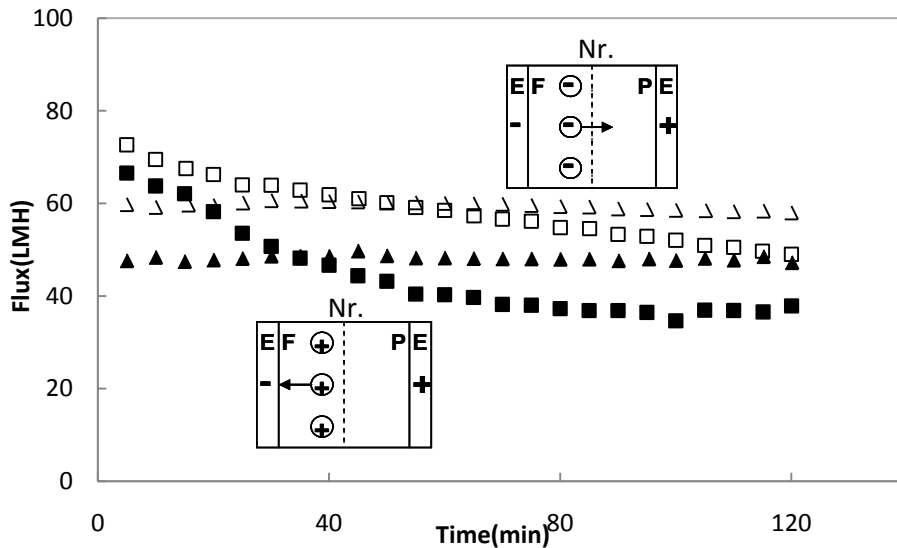

Figure 4.27 Comparison of the permeate flux obtained at different feed pHs during MF and EMF of BSA at polarity-MF+ (■)EMF Nr.3, pH 4.7±1.2 (□) MF Nr.5,pH 3.8±0.3(▲)EMF Nr.6,pH 9.5±0.4 (Δ)MF Nr.7,pH 9.5±0.4 (details on experimental condition for Exp. Nr.5 and Nr.7 can be referred to Table 4.3)

Exp. Nr.3 and Nr.5 were all operated with feed solution at acidic condition, therefore the permeation flux can be compared BETWEEN each other to investigate the influence of electric field on flux. As shown in the Figure, permeation flux in Exp. Nr.3 was lower than that in Exp. Nr.5, even though the electric field in Exp. Nr.3 was supposed to drag the positively charged BSA away from membrane. In addition, the fact that the feed pH in Exp. Nr.3 as shown in Figure 4.26 (A) underwent changes during the experiment was also the reason that flux decreased. Normally, the flux is the lowest when the solution pH is equal to the pI of the protein [127,128]. Exp. Nr.6 and Nr.7 were operated with the feed solution at basic condition. By applying the electric field with direction of dragging negatively BSA towards the membrane, the permeation flux from Exp. Nr.6 decreased and was lower than that from Exp. Nr.7. Even though the BSA was dragged towards the membrane, the permeation flux was very stable. It seemed that the feed pH has very big effect on the permeation flux, acidic pH was easier to foul the membrane and the flux decreased during the experiment while the basic pH gave more sustainable flux even though in Exp. Nr.6 the flux was reduced.

In Figure 4.28, the rejections from Exp. Nr.3, Nr.5, Nr.6 and Nr.7 were calculated and compared. The rejections in Exp. Nr.6 and Nr.7 were compared at 5, 30, 60, 90 and 115 min during the experiments. And the rejections in Exp. Nr.3 and Nr.5 were compared at 30, 60, 90 and 115 min.

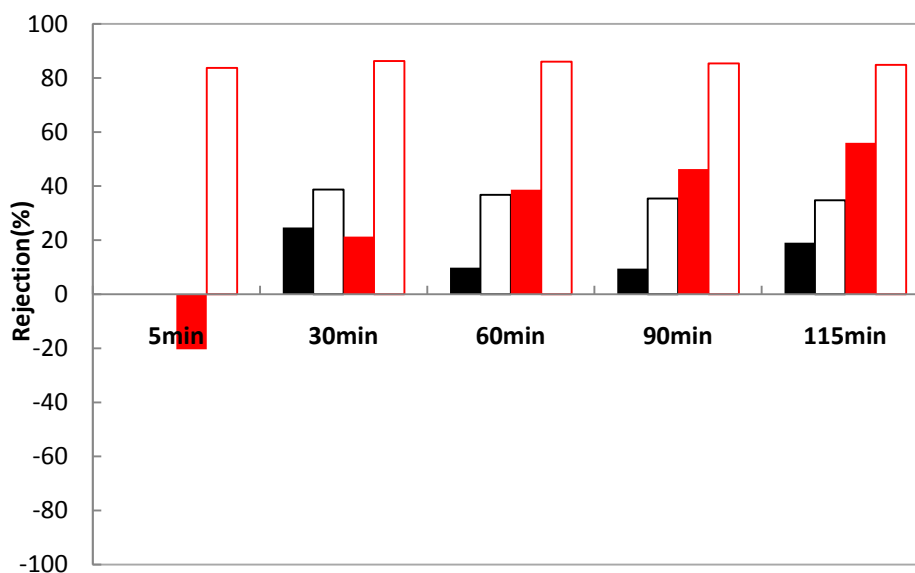

Figure 4.28 Comparison of BSA rejections obtained at different feed pHs during MF and EMF of BSA at polarity-MF+, (■)EMF Nr.3, pH 4.7 ± 1.2 (□) MF Nr.5, pH 3.8 ± 0.3 (■) EMF Nr.6, pH 9.5 ± 0.4 (□)MF Nr.7, pH 9.5 ± 0.4 (details on experimental condition for Exp. Nr.5 and Nr.7 can be referred to

Table 4.3)

By applying the electric field in Exp.Nr.3, it is expected that the transport of positively charged BSA should be decreased therefore rejection can be expected to be higher than that when operating without electric field. However, the rejections from Exp.Nr.3 were found always to be smaller than that from Exp. Nr.5 and not as stable as in Exp. Nr.5, which can be ascribed to the less effective electrophoretic force due to low current density and to pH variation during Exp. Nr.3. Rejections at 60 and 90 were also found the lowest. This was mainly due to the fact that at time between 60 to 90min, the feed pH in Exp.3 was at around the pI of BSA. Due to the smaller size of protein at pI, the transport through the membrane should be more easily when the membrane has pore size bigger than the size of BSA. This observation was also found by other researchers [129,132]. When BSA became negatively charged at 115min in Exp.Nr.3 due to pH change, the rejection still increased slightly as compared to that at 90min. This can be due to electrostatic repulsion between membrane and BSA when they have similar charge.

Let's look at the rejections from Exp. Nr.6 and Nr.7, the rejections in Exp. Nr.7 stayed very stable at around 80%. It was expected that the mass transport of BSA should be enhanced in the presence of electric field dragging the BSA towards membrane. The rejections shown in the Figure from Exp. Nr.6 were in accordance with the expectation. At the start, the effect of electrohoretic force was very effective, a 5-fold decrease of the rejection was observed, with the time going, rejection increased gradually due to membrane fouling but never reached to the rejection obtained from Exp. Nr.7.

The resulting current from the two experiments were also presented in Appendix 4.

4.3.2.3 MF Membrane fouling tendency after each experiment

Like in the UF part, the fouling tendency of each experiment by looking at the water permeability before and after experiment is presented in Figure 4.29. Again, the purpose of showing these results is to give the ideas about 1) whether the application of electrical field in MF filtration helps depolarize membrane surface 2) whether the feed pH has effect on membrane fouling.

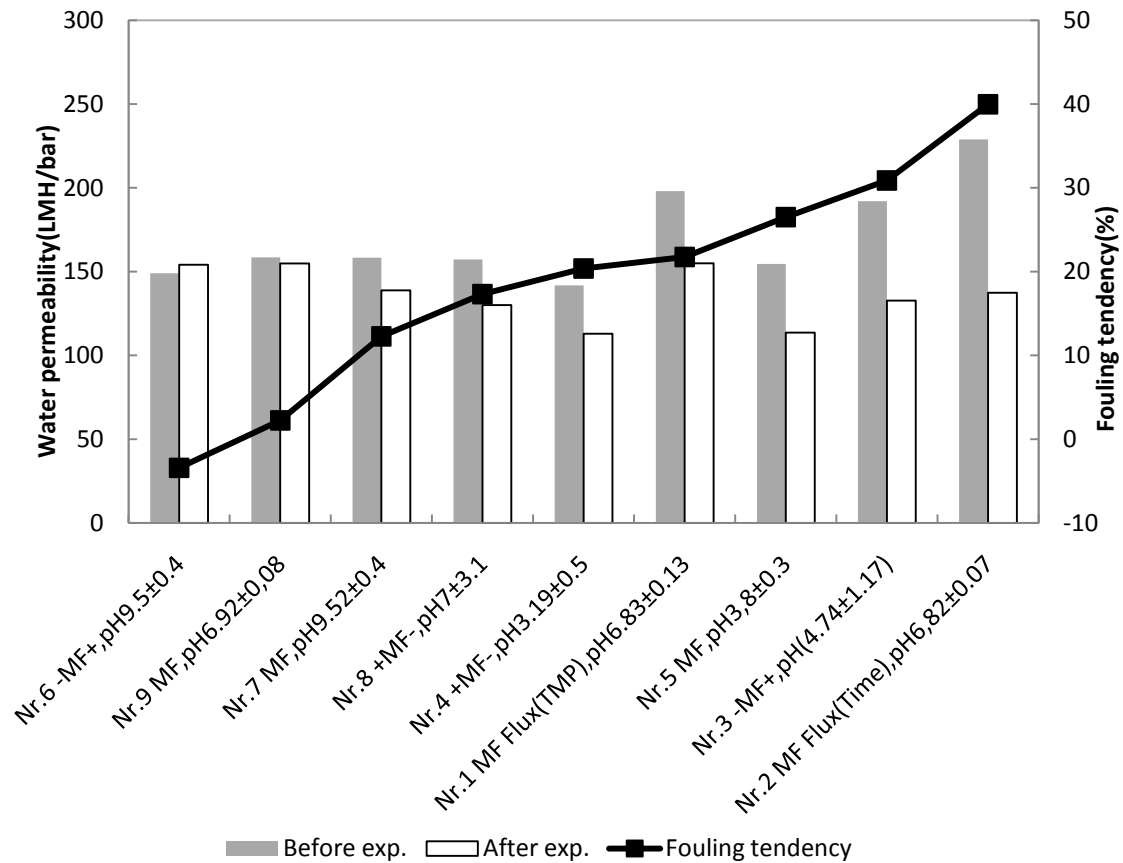

Figure 4.29 Comparison of MF membrane fouling tendency of each experiment by comparing the water permeability before and after each experiment

The water permeability after caustic cleaning in the first 3 experiments can be restored to around 200LMH. After the first 3 experiments, the water permeability seemed not possible to restore to 200LMH, it stayed at around 150 LMH. It indicated that operating with feed solution at acidic or basic condition has affected the cleaning method.

Fouling tendency defined in section 4.3.1.3 was used to evaluate the membrane fouling of each experiment. One of the obvious observations in Figure 4.29 is that experiments operated with acidic feed solution has higher tendency than experiments operated with basic feed solution. Even though in Exp. Nr.6, the electric field was supposed to enhance the mass transport, the membrane was not fouled at all in terms of water permeability change. This discovery probably can be explained by the fact that the electrostatic repulsion in Exp. Nr.6 was very stronger which prevent BSA clinging on the membrane. It seemed that the feed pH played a very important role in membrane fouling on this type of MF membrane which was also the case in the UF membrane.

4.3.2.4 Summary

We can summarize from the studies with MF membrane both in absence and presence of electrical field:

- In normal MF filtration, pH also did affect the flux and rejection like the observations found in UF. Operating with feed solution at acidic condition (lower than pH 4) gave lower flux and rejection as compared with operating with basic feed solution. It suggests that the MF membrane has negative zeta-potential at range of pH that used.
- Normal MF filtration operated with permeate solution circulating by permeate pump influenced the mass transport by introducing stronger diffusion transport
- When the scenario was that BSA^- was to be electro-transported away from the membrane under the influence of electrical field, the flux increased as compared with normal MF filtration due to the depolarization effect.
- When the scenario was that BSA^+ was to electro-transported away from the membrane surface, the flux didn't turn out to increase. This may again due to the electrostatic interaction between BSA^+ and membrane.
- It was more favored to operate with basic feed solution in terms of having more sustainable flux.

4.4 Conclusions

From the studies of BSA filtration with UF membrane (a tight membrane) and MF membrane (a more open membrane), a general conclusion can be made: the charge of the protein and the charge and properties of the membrane are all important factors regarding the transport of protein. The charge of protein also influences the interactions between the membrane and the protein molecules. If the protein molecules are uncharged they can come closer to the membrane and can thus easily either foul UF membrane or pass through the MF membrane. If the proteins are charged, they repel each other, and if they have the same charge as the membrane they are also repelled by the membrane. The charge of the membrane is of importance as it can either repel the protein molecules or attract them. If the repulsion between the proteins and the membrane is too great the rejection will decrease. On the other hand, if the attraction is too high the proteins will be adsorbed onto the membrane and foul it.

Several other interesting points can be drawn based on the results from filtration with and without electric field.

1. Feed pH seemed to be the most critical parameter which determined the interaction between the membrane and BSA. It has been found out that the acidic pH was not favored both for the UF and MF membrane used in our studies due to the membrane-protein attraction.
2. By applying the electric field, the rejection or transmission of BSA can be very well manipulated especially with basic feed solution. While in acidic condition, due to the electrostatic attraction between membrane and BSA, the expected rejection was not as easy as in basic condition to achieve.
3. When the electric field worked to depolarize the membrane especially with basic feed solution, the permeation flux can be enhanced. And the flux obtained when the feed solution was basic was very stable. While the permeation flux decreased when operating with acidic feed solution.
4. The pH of feed solution should be well maintained in order to have stable charge condition. The permeate conductivity should also be kept at certain level in order to avoid water splitting.
5. By using more open membrane, in our case the MF membrane didn't generate higher flux. This indicated that the membrane material is the key to determine the flux

Chapter 5

EMF of industrial enzymes

In this chapter, the technological feasibility of EMF for the separation of a side activity LP from a main activity PLA was studied, validated and compared with conventional MF filtration. In order to do so, MF filtration of single enzymes was performed at various TMP to find out the optimal operation TMP in section 5.3.1. Then effects of solution pH and electric field strength were also investigated. Following the MF filtration of single enzyme, experiments run with binary mixture using MF with and without electric field were performed in section 5.3.3. The separation performance was compared between the conventional MF and EMF. Two membranes were tested in the binary separation using EMF. Investigations of the effects of solution pH, feed concentration, electric field strength and TMP on separation performance were also carried out.

5.1 Introduction

In the previous two chapters, amino acids and BSA were used as model solution to demonstrate the feasibility of electro-membrane filtration (EMF) technology on the application of filtration of small molecules and macromolecules and to understand the mechanism. Amino acids were used for two reasons: 1) its relative small size as compared to UF membrane used, therefore almost no membrane fouling is expected 2) it is effectively charged at certain pH, therefore very high mobility. It has been found that by applying the electric field, model amino acids Glu and Leu can be separated with very high separation factor. When it comes to BSA filtration, it has been found that by applying the electric field the rejection of BSA can be controlled due to the external electrophoretic force on the charged BSA. The change of rejection as compared to that obtained from MF filtration was extremely distinct when the solution pH was basic. When the feed pH was acidic, severe membrane fouling took place immediately and the effect of electrophoretic force on rejection and permeate flux was not favorable.

In this chapter, the operation of EMF on the application of industrial enzyme separation was performed. Two industrial enzymes: phospholipase (MW 13.3KDa, pI 7.68) and lipase (MW 29.3KDa, pI 4.7) were used to demonstrate the feasibility of EMF for enzyme separation. The

reasons why these two enzymes were chosen were: 1) the MW of them is close with each other, therefore it can be expected that normal MF filtration will not be possible to separate them. However, the pI of these two enzymes seem quite distinct, based on the difference of pI, EMF could be an interesting alternative to separate them. It is also good model to demonstrate the applicability of EMF on the application of enzymes separation which normal membrane filtration could not be achieved. 2) it has been known that most commercially available phospholipase products are accompanied by lipase activity [133,134]. From this point of view, it is very interesting that the lipase can be removed from the main products. EMF can be the candidate to perform the task. And it is very interesting to evaluate the separation performance with EMF. In order to clearly show why these two enzymes were chosen, a Figure telling the operation window of EMF and normal membrane filtration is presented as below.

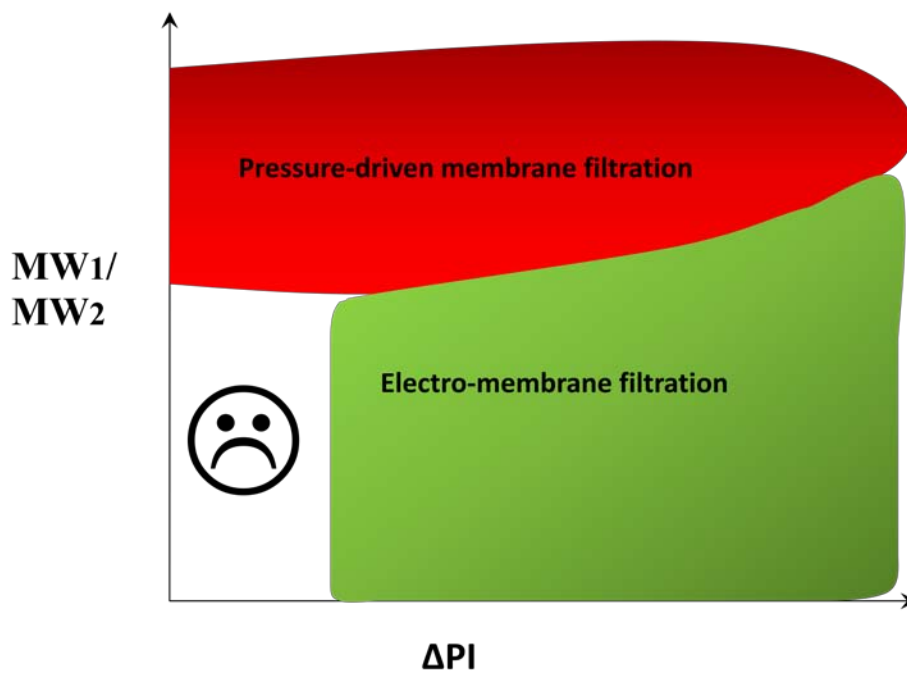

Figure 5.1 The operation boundary for EMF and normal membrane filtration for enzyme/protein separation

Figure 5.1 is plotted by the ratio between MWs of two molecules against the difference of electrophoretic mobility which was mainly determined by solution pH. As Figure 5.1 shows, in separation application normal membrane filtration can only be used when the two molecules have distinct MW difference. However, if the two molecules have distinct difference of pI or precisely speaking difference of mobility in electric field, they can be separated with EMF though the MW

difference is not big. When the MW and pI of two molecules are close, neither MF nor EMF shall be considered as potential separation process.

When separating one component from the other one, usually there are two ways of operating the separation dependent on what component is to be removed from the membrane, as the following Figure shows.

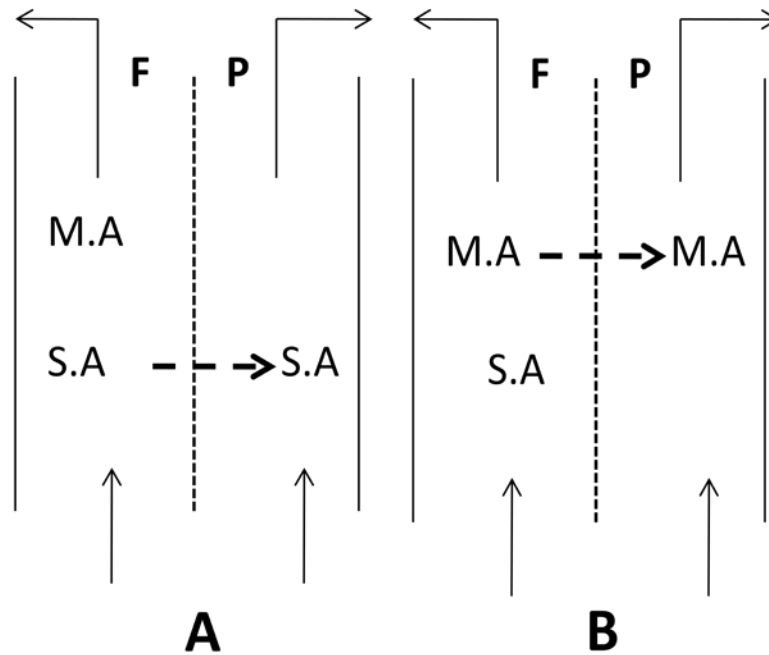

Figure 5.2 Two ways of operating the separation dependent on which compartment the target protein transported (A) side activity (S.D) collected in permeate (B) main activity (M.D) collected in permeate

Figure 5.2 (A) shows the situation where the side activity is removed from the permeate and the main activity is kept in the feed. Similarly, Figure 5.2 (B) shows the opposite situation where the side activity is kept in the feed and the main activity is removed from the permeate. Taking the consideration of the fact that PLA is regarded as main activity in our case i.e having higher concentration in the mixture, therefore it might be more efficient to remove the side activity into permeate. Besides, LP is more charged than PLA at pH above its pI as Figure 5.3 shows, thereby it is more effective to remove LP with electrotransport. Based on those considerations, operating model A was chosen in the separation experiments.

In order to investigate the possibility of separating PLA and LP by EMF, Figure 5.3 telling the charge condition of these two enzymes as function of solution pH is presented (calculated based on the amino acid sequence and dissociation constants).

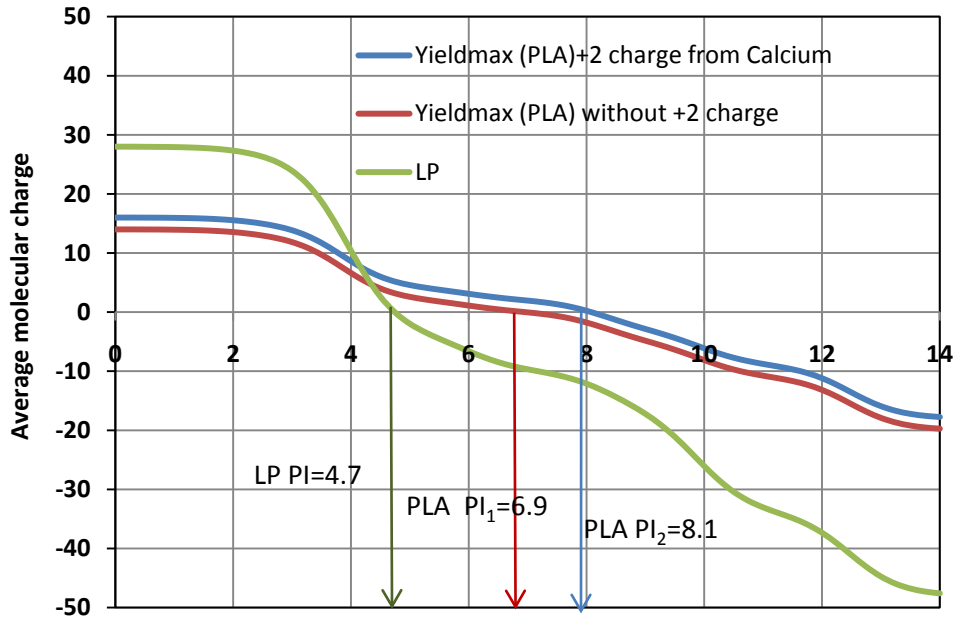

Figure 5.3 Average molecular charge of PLA and LP as function of solution pH (calculated by Novozymes internal software)

According to the Figure, the pIs of LP and PLA are 4.7 and 8.1, respectively, which are close to the theoretical ones. PLA can have two pIs dependent on that if the calcium in the structure is considered as the charge contribution.

It can be clearly seen that the selection window of pH in order to make PLA and LP separated by EMF can only be made between pH 4.7 to pH 8.1. Since the operation model A as Figure 5.2 shows has been chosen, the polarity of EMF should fixed at $-MF+$. Based on the principle of EMF, we propose the model of mass transport of each enzyme as function of pH in order to choose the right pH.

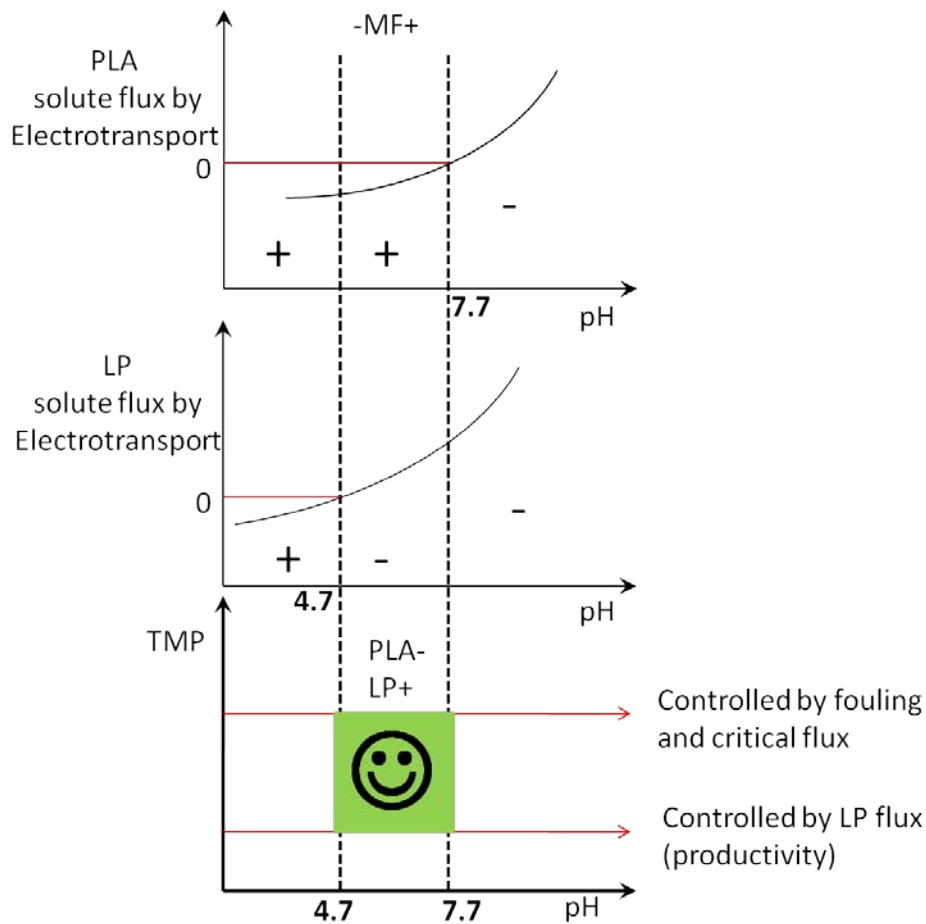

Figure 5.4 Operation pH selection based on the solute flux of LP and PLA as function of pH by EMF

Take LP as an example, as shown in Figure 5.4 when the pH is bigger than its pI 4.7, the solute flux will increase because at polarity $-MF+$, the mass transport will be enhanced due to the effect of electrophoretic force. Similarly, the mass transport will be weakened when the pH is smaller than 4.7. In PLA and LP separation, we expect that the solute flux of LP should be as great as possible while the solute flux of PLA should be as small as possible. Therefore, in theory the pH of the operation should be chosen between 4.7-7.7.

PLA is expected to be positively charged in order to have lower transmission in the presence of electric field. Also taking the consideration of smaller MW of PLA and much higher concentration in the feed mixture, the transport of PLA should be counterbalanced by electrophoretic force. Based on those considerations, the pH in all the experiments will be operated between 5-5.5. Meanwhile, the operation TMP should also be chosen carefully because that on one hand we need to have high

flux therefore high productivity and on the other hand we need to have sustainable flux therefore low fouling.

5.2 Materials and Methods

The raw solution of phospholipase produced from *Aspergillus oryzae* was purchased from Novozymes Kalundborg. The raw solution was then concentrated by UF in a diafiltration model and titrated at certain pH in Novozymes Pilot Plant. Those products were eventually used in the study. Two batches of PLA were used in the study. The first batch with lower bulk concentration and higher conductivity is named as Batch A and the second batch with higher bulk concentration and lower conductivity is named as Batch B in the following content.

In some of the experiments, a certain amount of sodium acetate was added in the feed solution in order to keep solution pH stable. Calcium chloride was added in some experiments due to the fact that enzymes need certain amount of calcium in order to be active. Details of the experimental operation will be stated in the respective experiments.

A polysulfone (PS) based microfiltration membrane (commercial name GRM 0.2 pp purchased from Alfa Laval) and a cellulose based microfiltration membrane (commercial name Hydrosart membrane purchased from Sartorius) both with pore size of 0.2 μ m were tested in the study. Details of these two membranes can be referred to chapter 2.

Single enzyme filtration with and without electric field was conducted with GRM 0.2 μ m membrane. In the MF filtration of single enzyme filtration, a conventional manner (i.e. without initial permeate solution circulating during the experiment) was applied. Feed flow rate in all experiments was kept at 90L/h. In EMF experiment, 0.1M Na₂SO₄ was used as initial electrolyte and 0.05M Na₂SO₄ was used as initial permeate solution respectively, the recirculation flow rate for electrolyte and permeate was kept constant at 70L/h and 22L/h. Cross flow velocity was kept constant at 1.25×10^{-2} m/s. 1 M acetic acid and 0.1 M NaOH were used to titrate the solution pH if needed. All the experiments were performed at constant temperature 20 ° controlled by a water bath.

5.3 Results and discussion

5.3.1 Single enzyme filtration

If we assume that LP and PLA are globular proteins with a density ρ_{protein} of about 0.7g/ml [135], the protein diameter d_{protein} can be calculated with:

$$d_{\text{protein}} = \sqrt[3]{\frac{6 \cdot M_{\text{protein}}}{\pi \cdot \rho_{\text{protein}} \cdot N_{\text{av}}}}$$

Where M_{protein} is the MW of the protein and N_{av} is Avogadro's number ($=6.02 \cdot 10^{23}$ molecules/mole). Based on the equation, we can calculate the diameters of LP and PLA are 0.005 and 0.004 μm . Therefore, the enzymes are much smaller (40 to 50 times) than the pore diameter of the membrane (0.2 μm), they are over an order of magnitude smaller than the pore size of MF membrane. Thus MF could be defined as a membrane operation where the enzyme is significant smaller than the average pore size of the membrane. In theory, the enzymes can pass through the membrane easily and fouling should be predominant by the deposition on the pore walls. However, in reality, the transmission of the enzymes through a membrane is not only governed by the ratio between membrane pore size and enzyme diameter but also controlled by many other factors such as feed pH, ionic strength and membrane properties. In fact proteins contribute significantly to membrane fouling. Therefore, filtration of single enzyme to investigate the transmission of PLA and LP is needed.

Before separating the binary mixture of the two enzymes, MF filtration of each single enzyme was studied in order to investigate the effects of the physicochemical parameters and process variables (pH, ionic strength, concentration of solute etc) on filtration performance. Then a few experiments carried out in the presence of electric field were to demonstrate whether separation could be improved by imposing external electric field.

5.3.1.1 PLA filtration

5.3.1.1.1 Effect of TMP on flux and transmission

Two experiments of conventional MF filtration of PLA solution (Batch A) at two constant feed pHs were carried out. The main aim of the experimental work was to investigate the influence of TMP on flux and transmission of PLA with conventional MF filtration at the defined operation pH range (4.7-7.7). The initial feed concentration for both of the two experiments were 15g/L, feed pH was controlled at 4.7 and 7.7 respectively. The experiments were carried out in a step-up and step-down method, i.e. TMP was first increased gradually to a certain TMP and then decreased. The operation was run for 25min at each TMP in order to reach steady-state, permeate sample was collected at every 5min. The transmission and flux at 25min of each TMP during the step-up and step-down experiments are presented in Figure 5.5 A and B respectively.

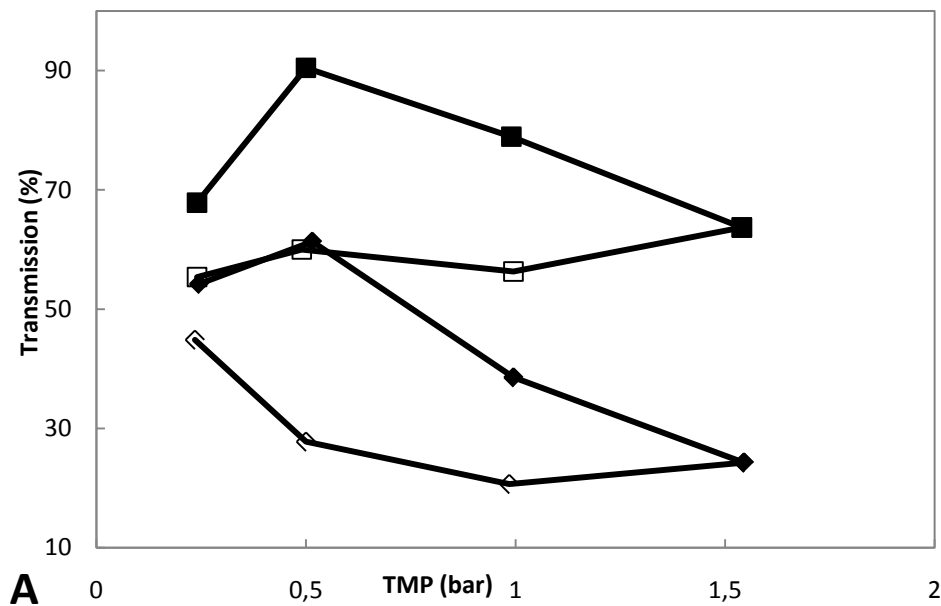

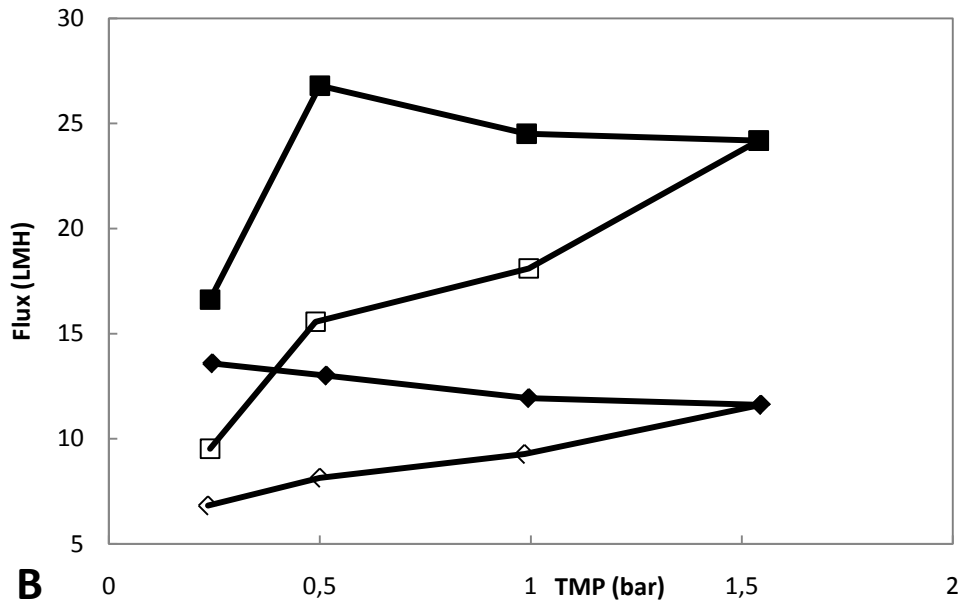

Figure 5.5 (A) The transmission of PLA and (B) permeate flux at 25min of each TMP obtained during MF of 15g/L PLA (■) pH 7.7, step-up (□) pH 7.7, step-down (◆) pH 4.7, step-up (◇) pH 4.7, step-down

As expected that the transmissions at all operation TMP with feed solution pH 7.7 were higher than that with feed solution pH 4.7. This was due to the smallest size of enzyme at its pI, which made the transport through the membrane easier. In the step-up period, increasing the TMP from 0.25 to 0.5bar caused an increase of transmission for both pH 4.7 and pH 7.7. This was due to the increased concentration polarization when increasing the TMP from 0.25 to 0.5bar. The increase rate of transmission at pH 7.7 was higher than that at pH 4.7.

However, the transmission decreased rapidly when the TMP was increased from 0.5 bar to around 1.5bar, transmissions were even less than the transmissions obtained at initial TMP 0.25bar. This observation was seen both at pH 7.7 and 4.7. The decrease in transmission when TMP was above 0.5bar might be due to a denser cake caused by the increase of TMP and an increase in the internal fouling as the protein aggregates are forced into the membrane [136,137]. When the cake becomes more compact the pores in the cake become narrower and the transport of solutes through the cake is hindered. Thus the transmission decreases. When the internal fouling increases, the pores in the membrane also become narrower and thus the transmission decreases.

When the TMP was above 0.5 bar, the decrease of transmission seemed to be faster when the pH was at 4.7. Membrane and enzyme interaction which caused the enzyme adsorb on the membrane may be the reason for this observation. During the step-down period, in the case of pH 7.7, the transmission stayed almost at the same level, which indicated that enzyme clogging or deposition on and inside the membrane pores probably took place. This is because at the pI of PLA, the enzymes started getting aggregated due to the lack of electrostatic repulsing. When fouling takes place inside the membrane pores, it is therefore not reversible even though TMP decreased. However, in the case of pH 4.7, the transmission increased with the decrease of TMP during the step-down period. This observation was due to the relaxation of enzyme deposition during the step-down period, which indicated that at pH 4.7 membrane fouling was mainly due to the deposition of enzyme on membrane surface.

With regard to permeate flux, it turned out to be higher in the case of pH 7.7 both in step-up and step-down periods. Lower flux obtained at pH 4.7 probably due to the fact that PLA is positively charged and membrane is negatively charged, therefore the attractive forces that occur between PLA and membrane might make PLA adsorb on the membrane surface and in the membrane pores. This will result in two things: membrane pore becomes narrower, and surface charge will change as positively charged PLA cover the membrane surface and the membrane pores. When the surface charge of membrane is change due to the adsorbed PLA the membrane will repel PLA and PLA aggregate in the solution. This will therefore low flux and transmission.

Again it shows that operating with pH 7.7, flux first increased with the increase of TMP, when the TMP was above 0.5bar, flux decreased slightly with the increase of TMP, which seemed to be very similar with the change of transmission. And it seemed that the limiting flux was reached at TMP around 0.5bar. While in the case of pH 4.7, flux decreased all the time with the increase of TMP, which indicated the increase of fouling rate was much higher than that of pH 7.7. The reason behind that probably was due to enzyme-membrane interaction caused the fouling. In the step-down period, flux in both cases decreased with the decrease of TMP, which seemed to be logically.

From these two experiments, it can be concluded that flux and transmission of PLA with MF filtration were dependent on the pH, which was further investigated in the next section. Both permeation flux and transmission showed relative lower when the solution pH was away from its pI. In the case of pH 4.7, the permeation flux declined to less than the flux at lower TMP. The transmission in both pH 7.7 and 4.7 increased with the increase of TMP to 0.5bar, then it started

decreasing with the increase of TMP due to the severe fouling taking place on the membrane surface and inside the membrane pores. It seemed that there is an optimum pressure, below which the driving force is too low and above which the increased fouling may cause a big decline in flux. Taking the consideration of flux and fouling, operation should be done at TMP below 0.5bar if MF filtration of PLA is going to take place. Therefore, MF filtration experiments at two pH (4.7 and 7.7) operated at 0.35bar for 2hours were carried out to investigate further the transmission and flux change as function of time.

5.3.1.1.2 Effect of solution pH on flux and transmission

We have seen that how the flux and transmission changed at different TMP during the conventional MF filtration. It is also important to investigate how the flux and transmission evolve during a long time operation at a constant TMP. Three experiments operated at different pH (4.7,5.4 and 7.7) were performed to investigate the effect of solution pH on transmission and permeate flux of PLA. The PLA concentration used in the three experiments was 15g/L, and the TMP was 0.35bar. The data of transmission and permeate flux are presented in the following Figures.

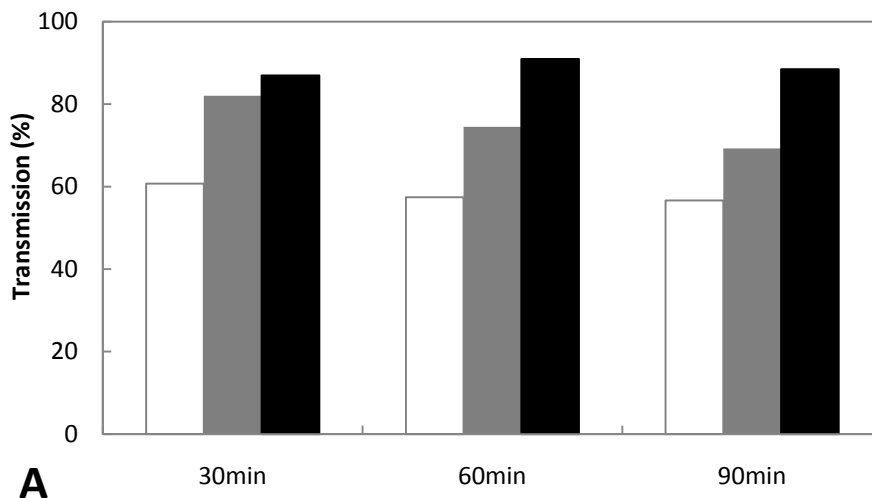

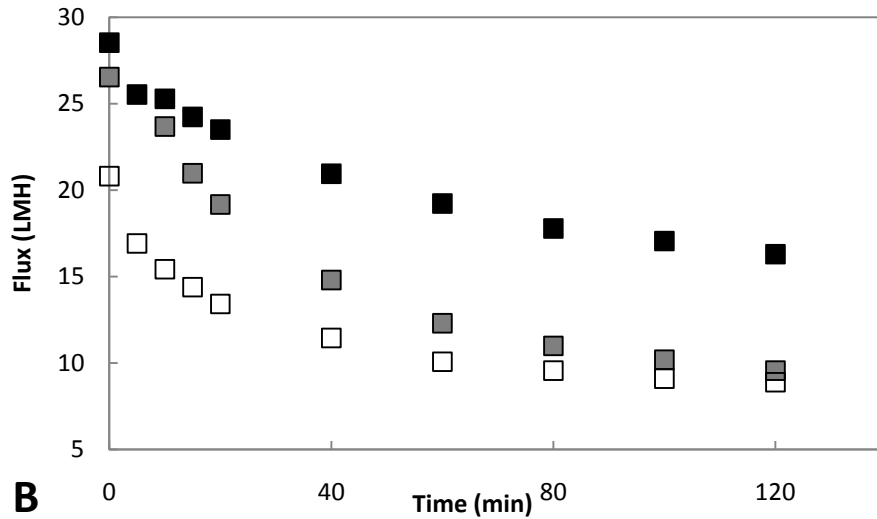

Figure 5.6 (A) Transmission of PLA and (B) permeate flux obtained at different solution pH during 2 hours' MF of 15g/L PLA at constant TMP 0.35bar (■)pH 7.7 (■)pH 5.4 (□)pH 4.7

The results clearly indicate that the transmission and flux are dependent on the solution pH. Transmission increased with the increase of solution pH. The results are also in agreement with the fact that highest transmission takes place near the pI of the protein. The transmissions obtained from pH 7.7 were nearly 30% higher than that from pH 4.7. The transmissions obtained at pH 7.7 and 4.7 were almost constant during the experiments, whereas the transmission decreased slightly from the start of the experiment ran at pH 5.4. The transmissions remained almost constant during the experiments ran at pH 7.7 and 4.7 suggested that the concentration polarization was almost constant.

Regarding the permeate flux, as can be seen in Figure 5.6 (B), fluxes decreased with the time in all the experiments due to membrane fouling and concentration polarization effects. The average flux also increased with the increase of pH. Fluxes decreased rapidly at the first hour and then the rate of decline became smaller. At pH 5.4 and 4.7, fluxes at the end of experiments were less than half of the initial fluxes. The highest flux was seen at pH 7.7 probably was again due to the smaller size of PLA at pI, which made the transport through the membrane easier therefore a higher flux can be obtained. In addition, the fact that at pI the electrostatic membrane-protein interaction is at a minimum can contribute to the higher flux. This observation was not in accordance with the results obtained from Huisman and co-workers [129] which reported that the flux in crossflow UF experiments of BSA with cut-off values in the range of 30 to 300kDa, the flux was lowest at pH equal pI. Similarly, Bansal *et al.* [138] reported that the flux decline during MF of hemoglobin

solutions was greatest at pH equal to pI, Palecek and Zydney [139] reported with similar results obtained from the filtration of BSA in a stirred cell system with 0.16 μ m PES membrane.

At pH 5.4 and 4.7, PLA was positively charged there is greater chance that PLA and membrane have electrostatic membrane-protein interaction presumably attraction, thereby protein adsorption occurs on the membrane. The difference of flux can also be attributed to protein deposition and protein aggregation at low pH (In the discussion with chemists from Pilot in Novozymes, they mentioned the solubility issue at low pH). Water permeability after the experiment in the case of pH 4.7 declined almost 60%, reflecting that at low pH membrane fouling was severe.

We can conclude that constant transmissions in both pH 7.7 and 4.7 were seen by operating MF filtration at TMP 0.35bar even though the membrane fouling resulting in flux decline was inevitable. Again, the pH has significant effect both on the transmission and permeation flux. The transmission and the flux showed to be the highest when the pH of the feed solution was equal to the pI.

5.3.1.1.3 Effect of electric field on transmission and flux

By applying the electric field in the direction of dragging the solute away from membrane, the transmission of this solute can be expected to decrease. The purpose of such experiment is to study the effect of electric field on the transmission as compared to the similar experiment which was run without electric field.

The effect of electric field on transmission and flux are shown in the following Figure 5.7 A and B respectively.

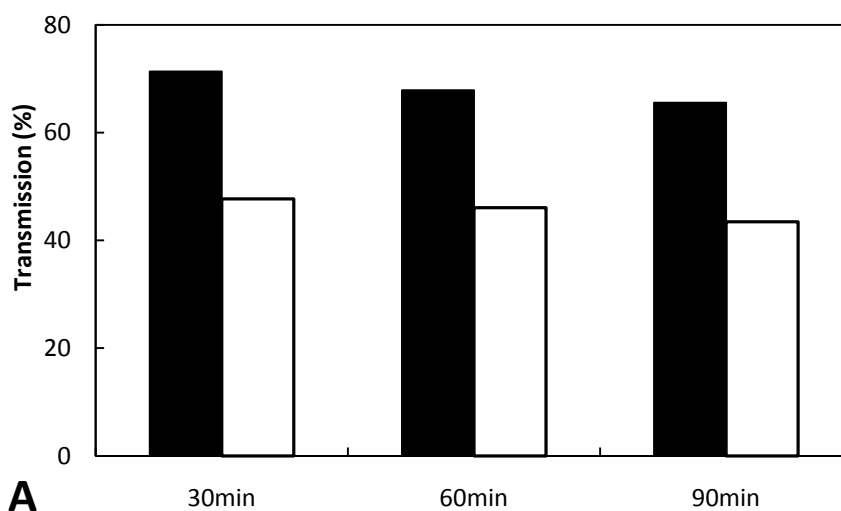

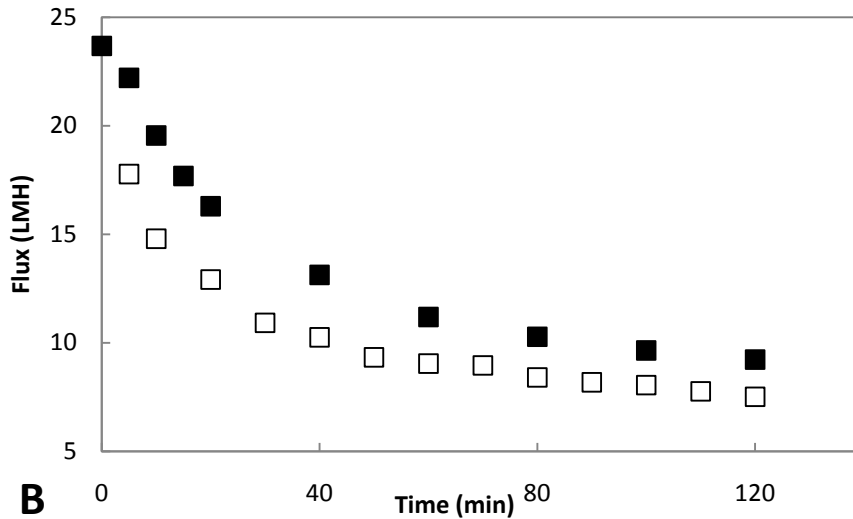

Figure 5.7 (A)Transmission of PLA and (B) permeate flux obtained from MF filtration with and without electric field, initial feed concentration 15g/L, pH 5, TMP at 0.35bar (■)MF (□)-MF+ at constant electric field strength 1364V/m

It can be seen from Figure 5.7 (A) that by applying the electric field at polarity –MF+, transmission of PLA decreased due to the external driving force dragging PLA away from membrane. Transmissions in EMF decreased nearly 30% as compared to that obtained from experiment run at same condition but without applying electric field.

Due to the depolarization effect, an increase of permeation flux is expected. Especially in the application of enzyme concentration by EUF, Enevoldsen *et al.* [2] reported a 3-7 times flux increased was obtained in comparison with the conventional UF for two industrial amylase solutions. We expected that the flux should be improved. Not like the results reported from Enevoldsen, the flux obtained in EMF surprisingly did not increase as compared to that obtained from conventional MF filtration. It declined rapidly during the first 30min and then stabilized in the rest time of experiment, which showed similar pattern as that in MF filtration. We speculated that this probably is due to the membrane that we used. First of all, MF membrane has much bigger pore size as compared to that of UF membrane, therefore fouling taking place inside of the membrane pore is predominant. Second, the membrane in the previous study has showed negative charged property, therefore interaction between the membrane and enzyme due to the electric attraction can be expected. Based on these two factors, we can suggest that even though the electric field is to drag the PLA away from the membrane, enzyme clogging inside the membrane pore is hard to remove at

such electric field strength. In short, the effect of depolarization is masked by the fouling taking place inside the membrane pore.

It can be concluded that it is possible to manipulate the transmission by applying the electric field, however effect of depolarization is not effective to enhance the permeate flux which was mainly due to the fouling taking place at low pH was hard to prevent.

5.3.1.1.4 Effect of batch variations on flux and transmission during EMF filtration

All the PLA used in the previous experiments were from Batch A which has activity approximately 24.9 ± 0.36 mg/g, conductivity around 1150us/cm, pH around 5.4. Batch A was in shortage when all the above experiments were carried out. Therefore, another batch named Batch B was delivered directly from the production line after UF filtration. The enzyme solution was not completely pure, it contained impurities such as polycarbonates, remaining amino acids, flocculation chemicals and other proteins which are produced during fermentation or added during the recovery process. In the flocculation process, some common chemicals such as CaCl_2 , flocculation polymers are therefore present in all the enzyme solution. In order to remove the salt added during the production, enzyme concentration from production line has to be diafiltrated with demineralized water. After diafiltration of Batch B, the stock solution of Batch B has activity around 64.3 ± 1.14 mg/g, conductivity around 500us/cm, pH around 7.3.

Two EMF experiments with the same initial feed concentration around 15g/L, feed pH at pH 5, TMP at 0.35bar but one using Batch A and the other using Batch B were carried out to see the effect of batch variations on flux and transmission during EMF. The flux and transmission were presented in the following Figures.

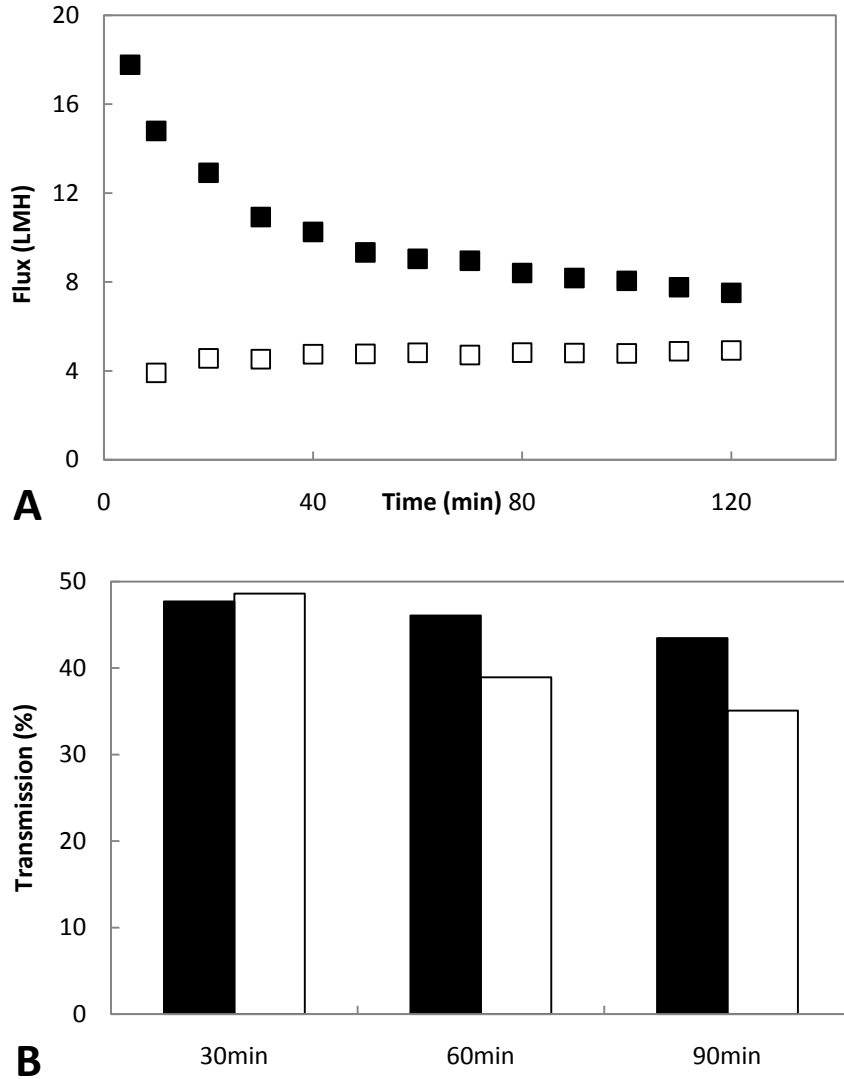

Figure 5.8(A) Permeate flux and (B) transmission comparison obtained from two different Batches of PLA during EMF of PLA, experiments were run with the same initial feed concentration 15g/L, feed pH 5, TMP 0.35bar and 1364V/m with polarity $-MF+$ (■) Batch A (□) Batch B

As can be seen in Figure 5.8 (A), we can see that using the more concentrated stock solution Batch A, the initial flux was much lower than that obtained from Batch B even though the feed concentration was the same. However, the flux obtained from Batch A experiment remained quite constant, which was not the case in Batch B. Regarding the transmission change, in both cases, transmission declined slightly during the experiment, however the decline rate seemed to be faster when Batch A was used. The transmission difference was not significant.

The flux decline in the case of using Batch A was probably due to the precipitation and aggregation taking place during the titration procedure when Batch A was used. The membrane probably was immediately fouled and formed a secondary layer therefore attaining a relative low but stable flux

5.3.1.1.5 Solubility issue at low pH

Several experiments regarding identifying the causes resulting in the precipitation and aggregation of PLA were conducted. Finally, it was found out that the precipitation phenomenon at low pH was resulted from the low conductivity of the feed solution. This was especially distinct when dealing with Batch B PLA. This solubility issue was eventually solved by adding certain amount of Na_2SO_4 . By adding 5mM Na_2SO_4 into the feed solution of PLA operating with EMF at pH 5, both flux and transmission increased by 20-30% as compared to that obtained without adding Na_2SO_4 . The increase of flux was probably caused by the amelioration of fouling due to the precipitant. The addition of Na_2SO_4 in this case helped increase the PLA solubility. However, addition of more Na_2SO_4 probably would cause flux decrease because when the ionic strength in the solution is high, it decreases the thickness of the diffuse double layer, the proteins are then shielded by other ions, thus acting more like uncharged molecules, and in addition an increased ionic strength can cause molecular contraction. This increases the aggregation rate and the density of the deposit layer, which eventually lowers the flux. Several researchers have reported that by increasing the salt concentration, lower flux was obtained during the filtration of proteins [132,140,141]. Therefore, in our case, an optimal ionic strength should be chosen, which should not only solve solubility issue but also flux issue.

The decrease of transmission was probably due to the decrease zeta-potential of PLA in a higher salt concentration, thereby the effect of electric field dragging PLA away from membrane was weakened. The flux and transmission were plotted in the following Figure and compared to that obtained without adding Na_2SO_4 .

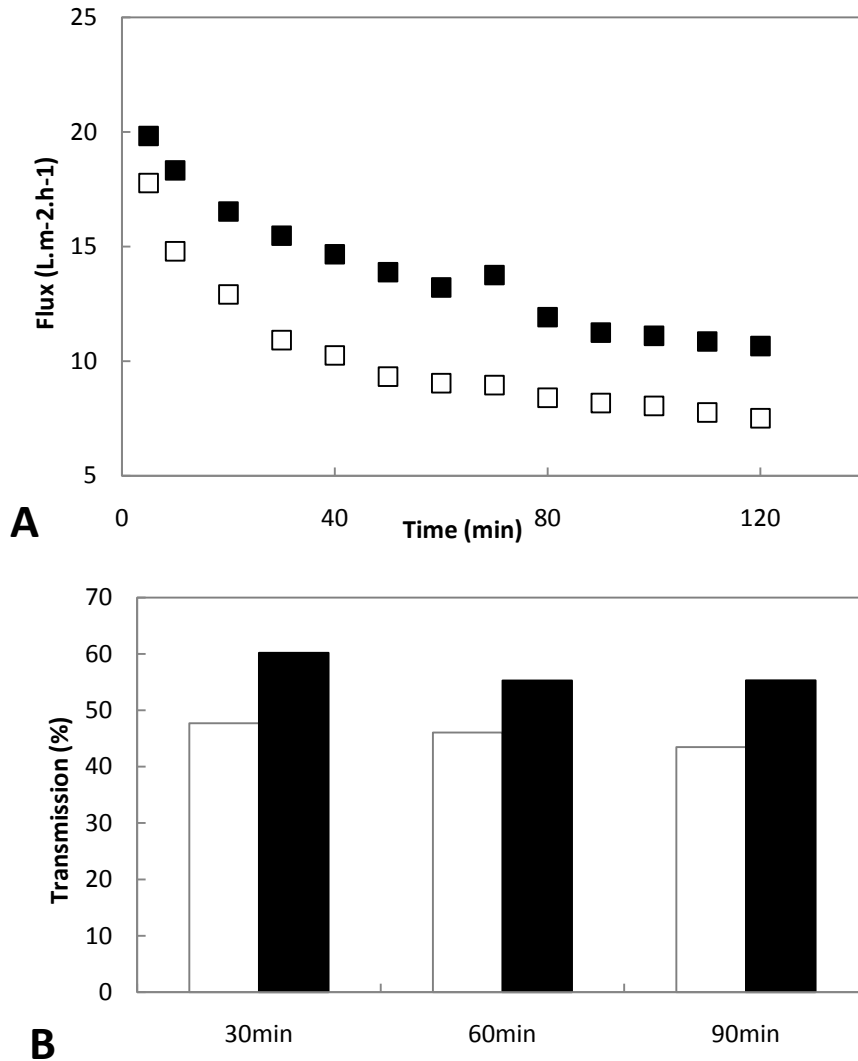

Figure 5.9 (A) Permeate flux and (B) transmission improvement by addition of 5mM Na₂SO₄, experiments were ran with the same initial feed concentration 15g/L (stock solution from Batch A), feed pH 5, TMP 0.35bar and 1364V/m with polarity –MF+(■) with addition of 5mM Na₂SO₄ in the feed solution (□) without addition of Na₂SO₄

5.3.1.2 LP filtration

5.3.1.2.1 Effect of TMP on flux and transmission

Likewise, two experiments of conventional MF filtration of LP solution at two constant feed pHs were carried out. The initial feed concentration for both of the two experiments were 2g/L, feed pH was controlled at 4.7 and 7.2 respectively. The reason why 2g/L solution was prepared was because in reality LP is considered as side activity. The experiments were also carried out in a step-up and

step-down method. The operation was run for 25min at each TMP, permeate sample was collected at every 5min. These two experiments were carried out in order to investigate the transmission of LP and permeation flux with conventional MF filtration at the defined operation pH range (4.7-7.7). The transmission and flux at 25min of each TMP during the step-up and step-down experiments were plotted in Figure 5.10 A and B respectively.

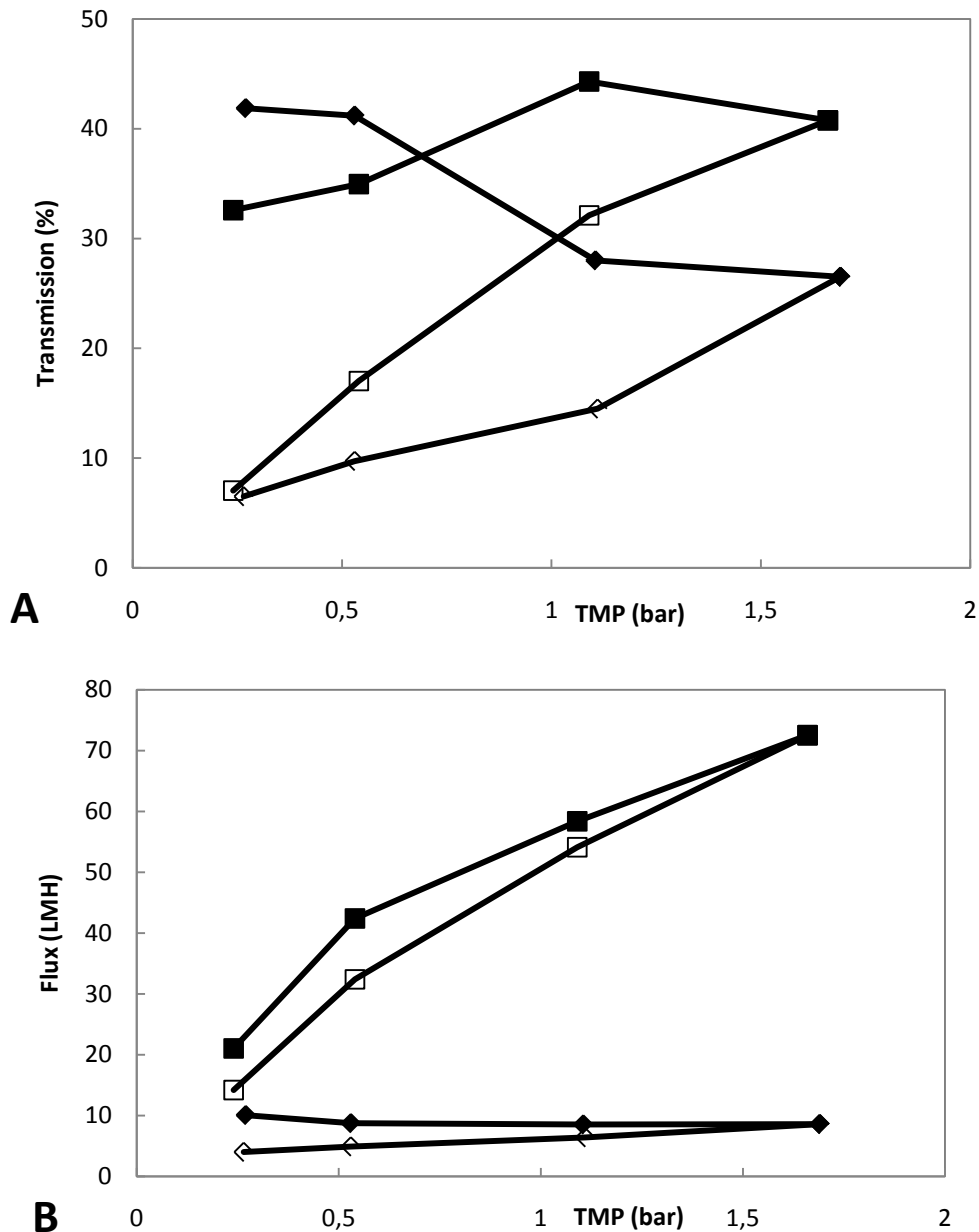

Figure 5.10 (A) Transmissions and (B) permeate flux during the step-up and step-down MF experiments, feed concentration 2g/L LP (■) pH 7.2, step-up (□)pH 7.2, step-down (◆)pH 4.7, step-up(◇)pH 4.7, step-down

Again, we see that the transmission was pH dependent. At pH 4.7, LP was neutral, transmission remained almost constant when the TMP was lower than 0.5bar, it then started decreasing rapidly when the TMP was above 0.5bar till around 1bar, finally it decreased very little when the TMP was increased further. The decrease of LP transmission might be due to a higher aggregation rate caused by the higher pressure and the fact that the aggregation rate at its pI is more affected than when the proteins are charged by an increase in pressure [142-144]. It might also be due to denser cake layer and increased internal fouling at high TMP.

At pH 7.2, LP was negatively charged, transmission increased with the increase of TMP until TMP at around 1.1bar, then it decreased slightly. The increase of transmission with increasing TMP can be due to the lack of a filter cake at this pH. Previous studies have indicated that this PS membrane probably is negatively charged, if the electrostatic repulsion between the protein molecules and membrane prevent aggregation and cake formation this would result in a high transmission and a high flux, which is in accordance with the results in this study. At relative low pressure, transmission obtained at pH 4.7 was higher than that obtained at pH 7.2. When the pressure was above around 0.6 bar, higher transmission was obtained at pH 7.2. Marshall and Jones [127,128] reported that in UF filtration flux became lowest and the amount of protein adsorbed to the membrane surface greatest when the pH of solution is equal to pI. Heinemann *et al.* [145] have reported that in the MF filtration of whey proteins at average pI 5.2, flux increased with decreasing pH, and the transmission of protein is highest at pI. In Figure 5.5 (A), we also saw that the transmission of PLA was highest at its pI. It was true that the highest transmission in this case was seen at pI, however, it only happened at low TMP. As compared to Figure 5.5(A), the highest transmission of PLA was seen at pH 7.7 during the whole experiment, while in this case, the highest transmission of LP indeed was seen at its pI, but then it started decreasing. It seemed that the membrane itself was very much influenced by the solution pH. At low pH, this membrane seemed to be easier fouled, therefore a decline of transmission was seen when the TMP increased above certain bar. A rapidly decrease of transmission with the decrease of TMP during the step-down period in both cases was found, which presumed that second layer or pore blocking was formed.

At pH 7.2, flux increased with the increase of TMP. At pH 4.7, flux remained almost constant during the step-up period. At the lowest TMP in the experiments, flux obtained at pH 7.2 was 2 times higher than that obtained at pH 4.7. With the increase of TMP, the difference of flux obtained

between the two pHs became bigger. Probably due to the low feed concentration used in this case, the flux in the step-down period declined slightly in both cases. The lower flux obtained at pH equal to pI is probably due to a more compact cake as the protein molecules can come closer to each other when they are uncharged. This is also in accordance with many other authors [127,128,146] saying that flux became lowest when the pH of solution is equal to pI.

Another three experiments at different TMP (1.15bar, 0.3bar and 0.15bar) at pH 7, feed concentration 2g/L for 2 hours. Data are presented in Figure 5.11. These experiments were thought to further investigate how transmission and flux change at different TMP. It has been found that at both TMP 0.3bar and 0.15bar, flux remained very stable at around 25LMH and 10LMH with time respectively, reflecting that the slow compression of the enzyme deposit in response to the applied TMP; transmission remained also very constant at around 35% and 20% respectively. The flux increased to nearly 75 LMH when TMP was increased to 1.13bar, but then decayed to a steady-state value after 60min of filtration. The steady-state flux at 1.13bar was at around 52LMH.

Transmission obtained at 1.13bar was nearly 56% and then decreased to 30%, which was even lower than that obtained at TMP 0.3bar. After the experiment, water permeability was checked; it decreased greatest at high TMP 1.13 bar. This proved that by increasing TMP it also compresses the fouling layer of the deposit enzyme on the surface and inside the membrane, thereby reducing the flux. Therefore, MF should be operated at low TMP, which is in agreement with Belfort's remark [147].

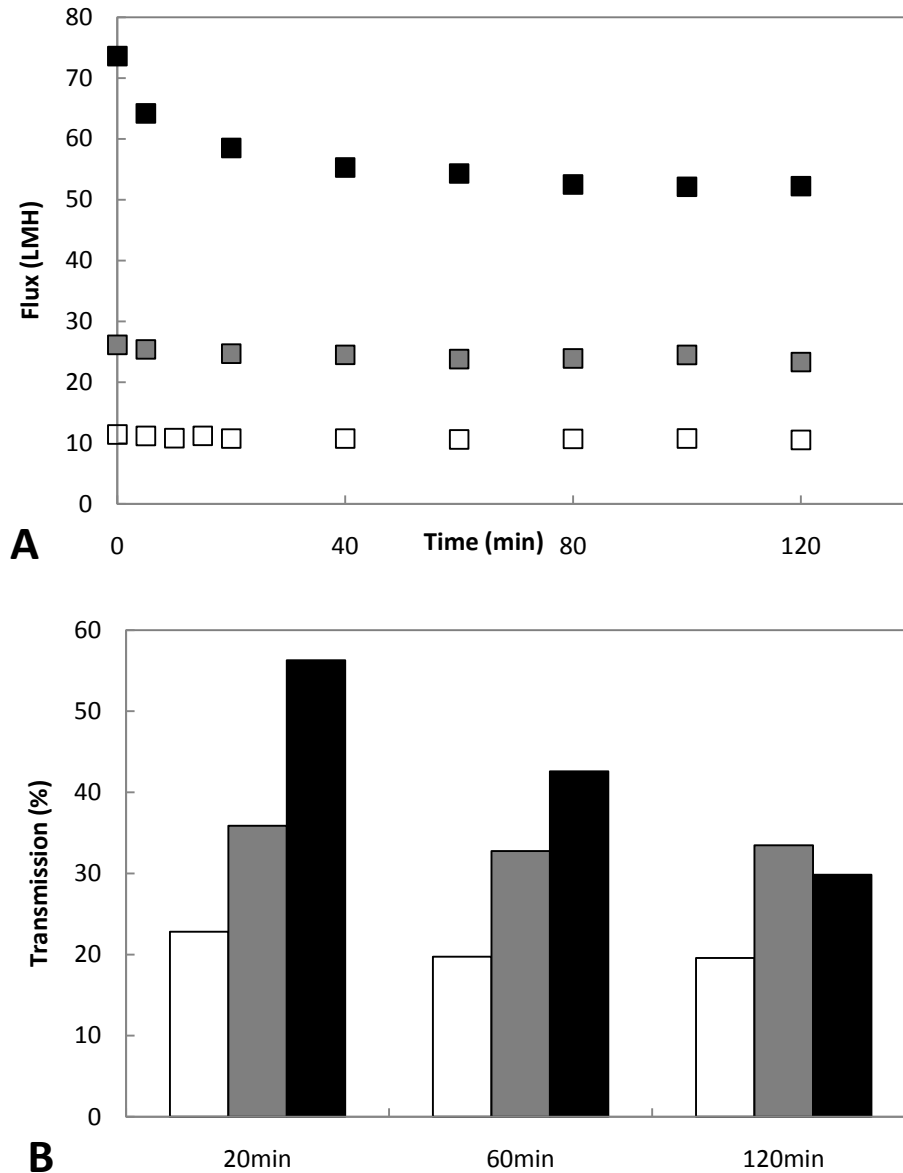

Figure 5.11 (A) Permeate flux and (B) transmission of PLA obtained during conventional MF filtration of 2g/L LP at pH 7 (■) TMP 1.13bar (■) TMP 0.3bar (□) TMP 0.15bar

5.3.1.2.2 Effect of solution pH on flux and transmission

Similarly, two experiments were performed at different pH (4.7 and 7) to investigate the effect of solution pH on transmission and permeate flux of LP. The LP concentration used in the two experiments was 2g/L, and the TMP was 0.3bar. The data of transmission and permeate flux are presented in the following Figures.

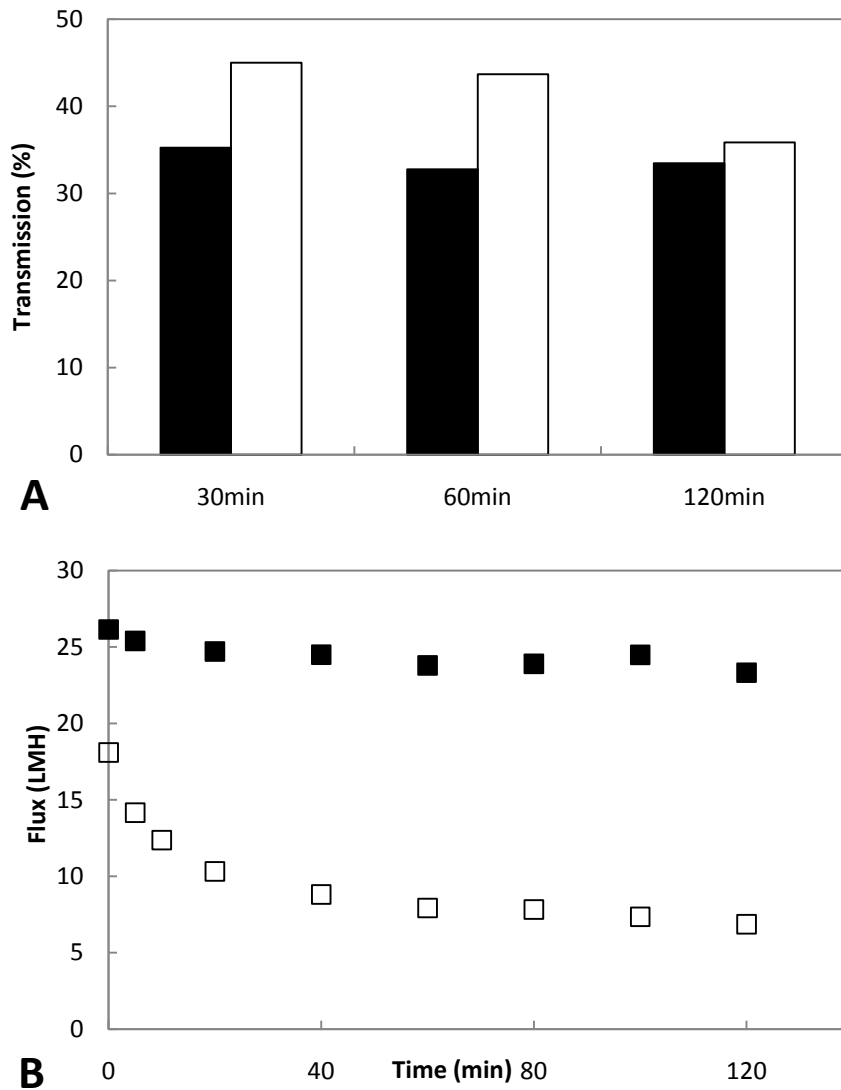

Figure 5.12 (A)Transmission of LP and (B)Permeate flux obtained at two pHs during MF of LP, initial feed concentration 2g/L, TMP at 0.3bar (■)pH 7 (□)pH 4.7

The transmission of LP was almost constant during the entire experiment at pH 7, while it decreased slightly at the end of experiment at pH 7. The results are also in agreement with the fact that higher transmission takes place near the pI of the protein.

Regarding the permeate flux, as can be seen in Figure 5.12 (B), flux at pH 7 remained almost constant at around 25LMH and turned out to be higher than that at pH 4.7 during the entire experiment. At pH 4.7, flux decreased from nearly 18LMH to a steady-state value around 9LMH after 1hour filtration. Unlike the data shown in Figure 5.6 (B), lower flux in this case was obtained at pH equal to the pI of LP. This might be due to less electrostatic repulsion between protein

molecules at pH equal to pI; thereby protein aggregates are more easily formed. As compared to 9.2% decrease of water permeability at pH 7 after experiment, the fact that water permeability decreased 52.7% in the case of pH 4.7 was also an indication of severe fouling took place at pH 4.

By comparing the data shown between Figure 5.6 and 5.12, it can be concluded that higher transmission can be obtained when pH was equal to pI, however it is not always true that lower flux would be obtained when pH was equal to pI.

5.3.1.2.3 Effect of feed concentration on flux and transmission

The effect of feed concentration on flux and transmission was investigated by running two experiments with feed concentration 2g/L and 20g/L at TMP 0.3bar, pH 7. The data are presented in Figure 5.13.

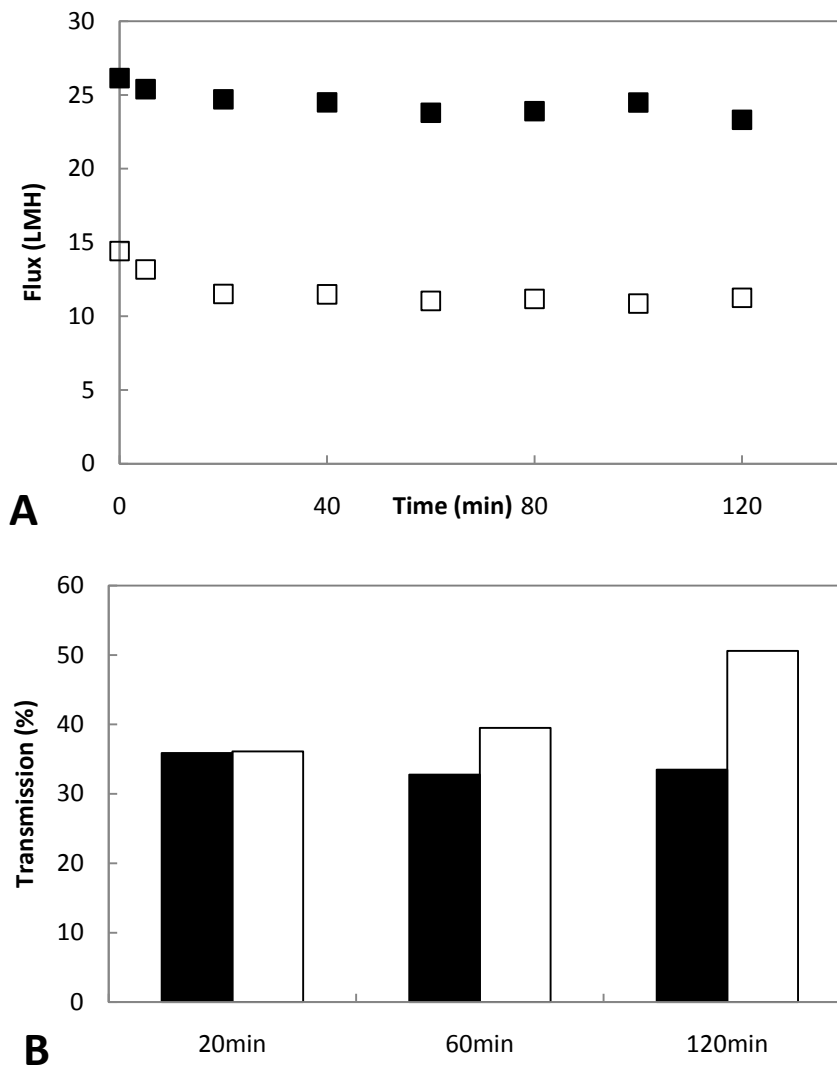

Figure 5.13 Effects of feed concentration on (A) Permeate flux and (B) transmission during MF of LP at TMP 0.3bar, pH 7 (■)2g/L (□)20g/L

As expected, by increasing feed concentration thereby increasing the viscosity of solution, resulted in a decline of permeate flux and the flux pattern was not the same as that obtained at low feed concentration. Permeate flux remained quite constant at low feed concentration while it declined initially and then decayed to a steady-state flux at high feed concentration. The decrease of flux and an enhanced flux decline when feed concentration was increased was due to a thicker concentration polarization layer.

The transmission increased gradually when increasing the feed concentration. This is due to that the concentration at membrane surface increases which results in an increase of transmission.

Water permeability after experiments was shown 22.4% decline when dealing with 20g/L LP, instead it decreased only 9.2% in the case of dealing with 2g/L LP.

By increasing the operation TMP above 1bar with 20g/L LP at pH 7 (data not shown here), transmission decreased almost 40% as compared to that shown in Figure 5.13. And it decreased with time, reflecting that the level of fouling increased when TMP was increased.

5.3.2 Summary

MF experiments of both PLA and LP using Alfa Laval PS membrane (0.2 μ m) has been carried out. The effects of TMP, feed concentration, solution pH, ionic strength and electric field on permeate flux and transmission have been investigated. The following results were obtained:

- Transmission and flux of both PLA and LP were dependent on the solution pH. The transmission of protein is caused by several effects that take place on the surface and inside the pores. All these effects are dependent on solution pH, for example the size of protein molecules and their aggregates thereby concentration polarization, protein-membrane interaction and the conformation of protein cake layer. Mochizuki and Heinemann [145,148] found that the transmission was highest at the solution pH equal to pI due to the conformation change of protein aggregate on the cake layer. The statement was applicable to PLA, but for LP highest transmission was only obtained at low TMP (in our cases below 0.5bar). The flux is not always lowest at solution pH equal to pI. More compact cake as the protein molecules come closer to each other when they are uncharged or adsorption of

protein on the membrane surface and in the membrane pores are the two factors resulting in lower flux.

- There is an optimal pressure, below which the driving force is too low and above which the increased fouling may cause a big decline in flux. In our case, the optimal TMP is below 0.5bar which was confirmed with the statement made by Belfort [147] saying that MF should be operated at low TMP. Running the experiments at TMP below 0.5bar can maintain the transmission constant and relative sustainable flux.
- By applying the electric field in the direction of dragging PLA away from membrane, the transmission can be manipulated. Transmission decreased as compared to that obtained from conventional MF filtration. However, the flux did not improve which indicated that the depolarization effect was not distinct in MF membrane.
- Batch variations had effect on the flux and transmission. Especially, the flux was much lower when using Batch A.
- At low pH, precipitation resulted from solubility issue was discovered. By increasing the salt concentration in feed solution helped increase PLA solubility, thereby precipitation phenomenon was solved, and flux was also enhanced. However, addition of salt decreased the zeta-potential of PLA, thereby weakened the effect of electric field. The amount of salt added into solution should be carefully chosen in order to balance the solubility and the increases of the agglomeration rate and the density of the filter cake thereby resulting in low flux.
- By increasing the feed concentration of LP, permeate flux declined due to a thicker concentration polarization layer, which also resulted in an increase of transmission.

5.3.3 Separation of PLA and LP

Following the experiments with MF filtration of single enzyme solutions, a series of experiments was carried out with binary mixtures using a polysulfone membrane and a cellulose based membrane in order to investigate the separation performance with and without electric field. Two different kinds of membranes were used in this investigation because of the fact that PS membrane from Alfa Laval showed very low water permeability. We would like to investigate if separation performance will be improved by using a membrane with more hydrophilic property and higher porosity. Therefore, a stabilized cellulose based membrane with low non-specific protein binding was tested in the separation experiment.

In order to demonstrate whether EMF could improve separation performance, separation of PLA and LP using conventional MF filtration as reference experiment was first performed. Following that, a series of experiments by EMF was investigated. The solution pH, feed concentration and composition, TMP and electric field strength on separation performance were studied. Of course, separation performance was also compared between the two mentioned membranes by running experiments at similar conditions.

5.3.3.1 PS membrane

In this part, a PS membrane was used as the porous membrane sitting in the middle of two cation-exchange membranes. First MF filtration of PLA and LP was performed in order to investigate whether PLA and LP can be separated just by conventional filtration. Then application of electric field was performed in order to study the feasibility of EMF on separation of PLA and LP. Investigations of feed concentration and batch variation on the EMF separation performance were carried out.

5.3.3.1.1 Separation of PLA and LP by MF filtration

Separation of PLA and LP by MF was studied. The experiment was ran with initial feed concentration 21.8g/L (Batch B PLA+LP) with 23.2% LP, pH 5 titrated by HAc, TMP 0.35, 25mM NaOAC was added in order to maintain the solubility caused at low pH and also to keep feed solution pH constant. The permeate flux, PLA and LP transmission and selectivity obtained in this study was shown in the following Figures.

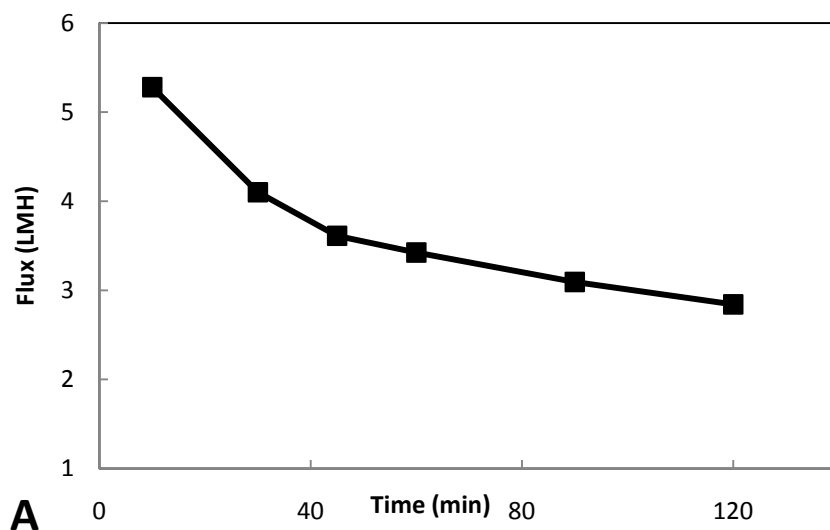

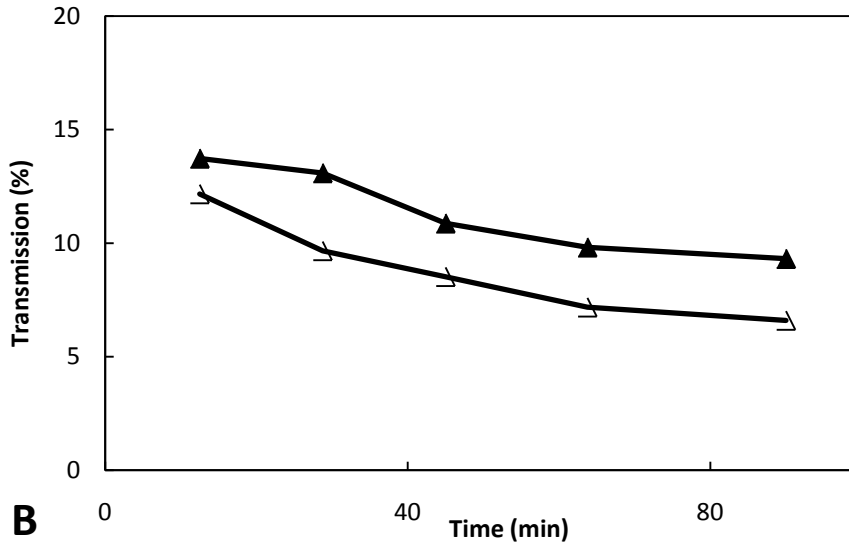

Figure 5.14 (A) Permeate flux and (B) PLA and LP transmissions obtained from the MF of PLA and LP, initial feed concentration 21.8g/L (PLA+LP) with 23.2% LP, pH 5, TMP 0.35bar
(▲)PLA(△)LP

In Figure 8 (A), it has been shown that by using Batch B of PLA lower flux was obtained as compared to flux obtained from using Batch A. However, almost constant flux at around 5 LMH was observed when running experiment with 15g/L PLA at condition of solution pH 5, TMP 0.35 and electric field strength 1364 V/m. As can be seen in Figure 5.14(A), the permeate flux of PLA&LP binary MF at beginning of the experiment was almost the same with that in single enzyme MF of PLA, however, it declined during the entire experiment to less than 3 LMH at the end. This decline probably was due to the presence of LP which resulted in more aggregates especially at pH close to pI of LP.

We can clearly see from Figure 5.14 (B) that transmissions of both PLA and LP decreased rapidly as compared to that obtained in MF of single enzyme (at least 30%), which indicated that membrane was more easily fouled by the mixture of PLA and LP. The reason for this probably was due to protein-protein attraction at pH 5, which resulted in heteroaggregation thereby increasing the size of aggregates. If we assume that the heteroaggregation involves equal molar participation of PLA and LP, there will still large amount of positively charged PLA. The adsorption of PLA will change the charge properties and thereby making membrane positively change. This could be another reason why a decrease of PLA transmission was seen. Last but not least, due to the relative larger size of LP, the presence of LP probably will create steric hindrance to the passage of PLA

through the membrane. Since protein tends to foul membrane more at solution pH equal to pI, the presence of LP at pH 5 will accelerate the fouling rate, which eventually will cause transmission of PLA and LP decrease.

Selectivity obtained during the experiment is presented in Figure 5.15.

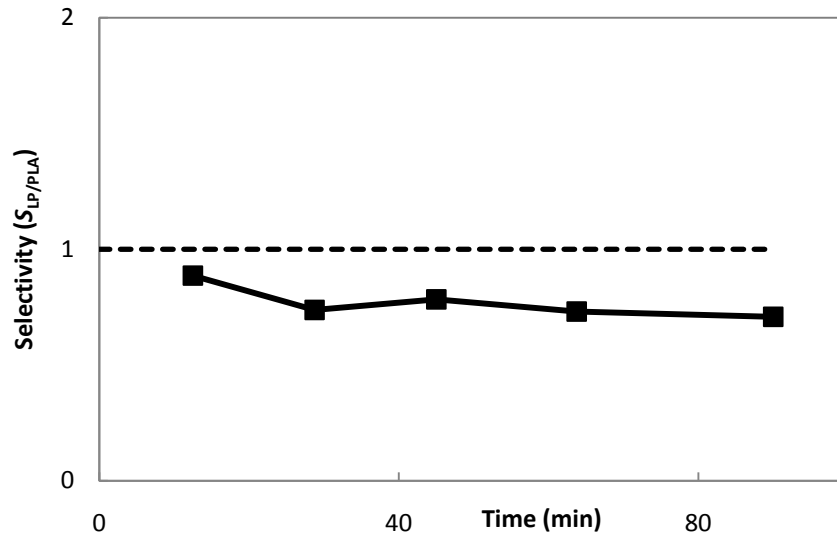

Figure 5.15 Selectivity obtained during the MF of PLA and LP, initial feed concentration 21.8g/L (PLA+LP) with 23.2% LP, pH 5, TMP 0.35bar

As clearly seen in Figure 5.15, the selectivity obtained in the experiment was close to unity at the beginning of experiment then it decreased slightly. When selectivity is less than unity, it means that PLA is transported faster than LP. Since the goal is to separate LP from PLA, it is expected that LP should be transported faster than PLA. Figure 5.15 clearly shows that it is not possible to separate LP from PLA just by MF.

It can be concluded that separation of PLA and LP was not possible by just running with MF. Flux obtained in binary MF filtration was rather low. The transmissions of both PLA and LP in binary MF filtration were much smaller than that obtained from single component filtration. This indicated that if this membrane is going to be used for the separation purpose with EMF operation model, productivity will be the issue because it has shown that transmission of LP was quite low. To improve the transmission of LP and low the transmission of PLA would be the goal of using EMF to achieve separation.

5.3.3.1.2 Separation of PLA and LP by EMF

5.3.3.1.2.1 Effect of electric field

Experiment ran with electric field was carried out to demonstrate whether separation of PLA and LP could be achieved. The experiment was ran with feed solution with concentration of 21.8g/L (Batch B PLA+LP) with 23.2% LP and 25mM NaOAc, pH 5 titrated by HAc, TMP 0.35, constant electric field strength 1364 V/m at polarity $-MF+$. During the experiments, the pH remained quite constant. Feed conductivity contributed from both enzyme and other ions was less than 2ms/cm. Both permeate flux and transmission are illustrated in comparison to respective results from MF of PLA and LP (in the above section) in the following Figures.

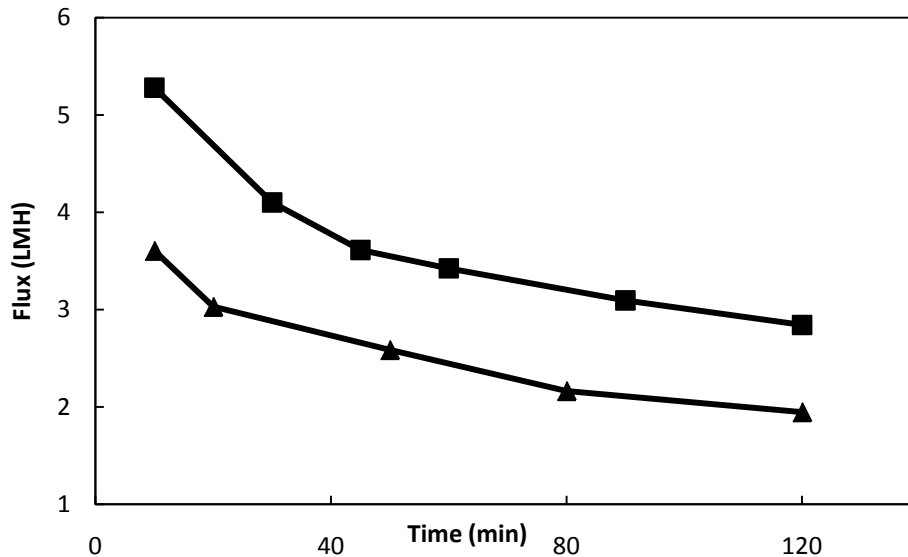

Figure 5.16 Effect of electric field on flux during EMF of PLA and LP (■)MF (▲)-MF+

As can be seen in Figure 5.16, permeate flux declined between 30-50% by applying the electric field at polarity $-MF+$. The decrease of permeate flux probably was due to enhanced membrane fouling caused by the enhanced LP transport resulted from electric field which acts as an additional driving force. Electric field dragging LP towards membrane caused more LP deposit on the surface of membrane thereby more severe fouling happened. It can also be due to the viscosity increase in the presence of electric field [149].

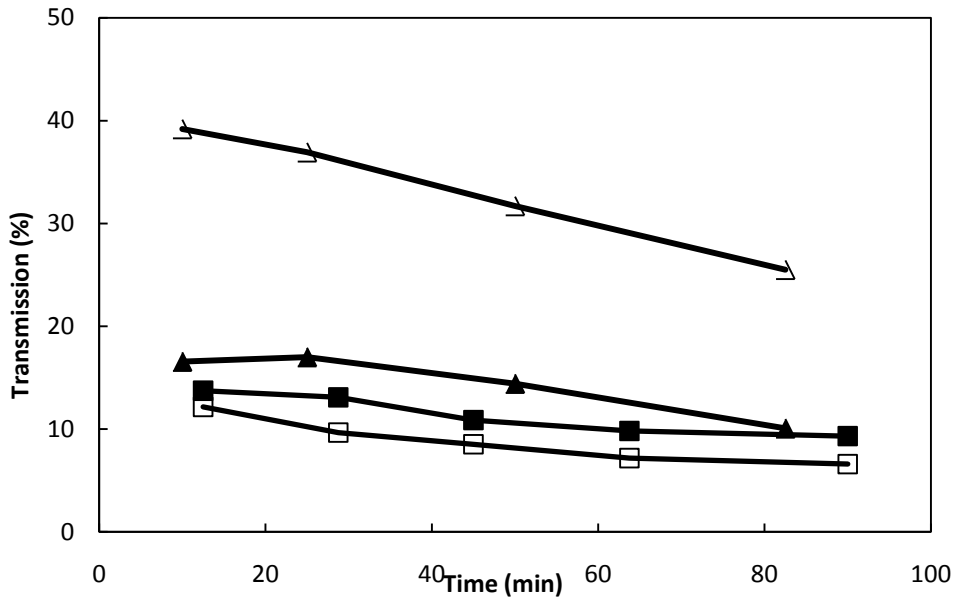

Figure 5.17 Effect of electric field on transmission EMF of PLA and LP (■)PLA, MF(□)LP, MF (▲)PLA, -MF+(Δ)LP, -MF+

We can clearly see from Figure 5.17, the electric field allowed to modify the transmissions of PLA and LP. This was especially distinct for LP, the transmission of LP almost increased four-fold at start, and then decreased gradually with time. The decline of LP transmission during the experiment can be ascribed to the increase of membrane fouling, which will cause a decrease of current utility. Surprisingly, the transmission of PLA obtained from EMF also increased slightly in comparison to that obtained from separation by MF. It is expected that the PLA transmission in the condition of EMF should be decreased due to electric field in the direction of dragging the positively charged PLA away from membrane. The reason why transmission of PLA increased slightly can probably be ascribed to the fact that the friction of LP on PLA molecular and its relative faster velocity of LP resulted from electric field, which push the PLA transport through membrane pore. It can also be due to lower charge density of PLA as compared to LP and to the fact that PLA has relatively larger diffusivity. Last but not least, the decrease of flux in EMF as compared to MF can also make PLA transmission increase. Jonsson [150] proposed a theory that the rejection of solute was proportionally dependent on the permeation flux in cellulose acetate reverse osmosis membranes, it had hardly no dependence of feed concentration.

The selectivity obtained from EMF was compared with that from MF, and is presented in Figure 5.17.

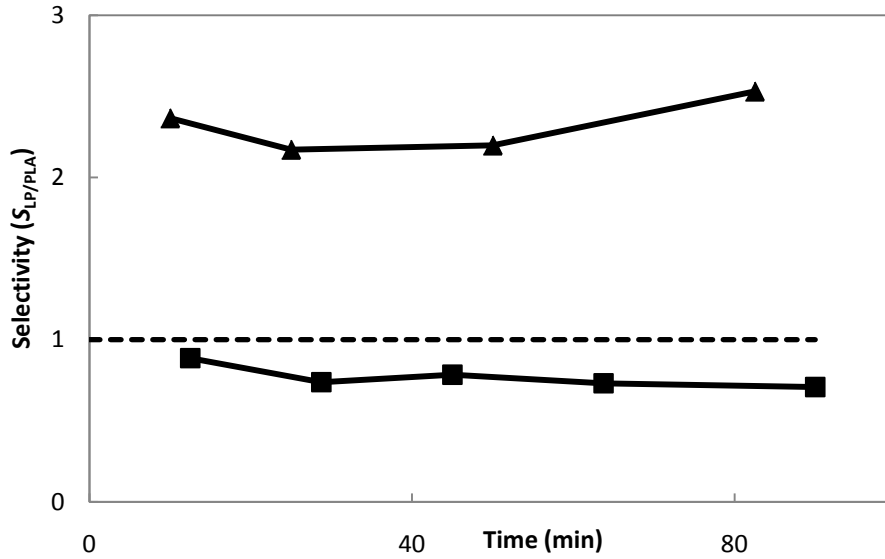

Figure 5.18 Comparison of the selectivity obtained during MF and EMF of PLA and LP (■) MF(▲) -MF+

As can be seen from Figure 5.18, more than two-fold of separation factor $S_{LP/PLA}$ was observed mainly due to the improved transmission of LP. In order to maximize the separation performance, one should expect the transmission of LP as high as possible and transmission of PLA as low as possible. There are several parameters such as solution pH, ionic strength, TMP and electric field strength which are responsible for the transport can be manipulated in order to have optimal separation. But here, the main idea was to demonstrate whether EMF can be used to separate PLA and LP whereas MF could not achieve.

In order to clearly demonstrate the effect of electric field on separation performance, Table 5.1 listing the comparisons of selectivity and LP purity in permeate are presented in the following table.

Table 5.1 Summary of experimental conditions and separation improvement in terms of selectivity and LP purity in permeate by applying electric field in MF

Experiment	pH	Feed concentration (g/L)	Percentage of LP concentration in feed (%)	Selectivity		Permeate LP purity (%)	
				10min	90min	10min	90min
MF, 0.35bar	5	21.8	23.2	0.89	0.71	21.11	17.61
-MF+, 0.35bar, 1364V/m	5	21.8	23.2	2.37	2.53	41.69	43.34

5.3.3.1.2.2 Effect of feed concentration

The effect of total feed concentration was studied in this section. The percentage of LP in the feed solution was kept almost the same between two experiments. The experimental conditions are listed in table 2. PLA used in these two experiments was from Batch A.

Figure 5.19 shows the permeate flux change during the EMF of PLA and LP both at high and low concentration.

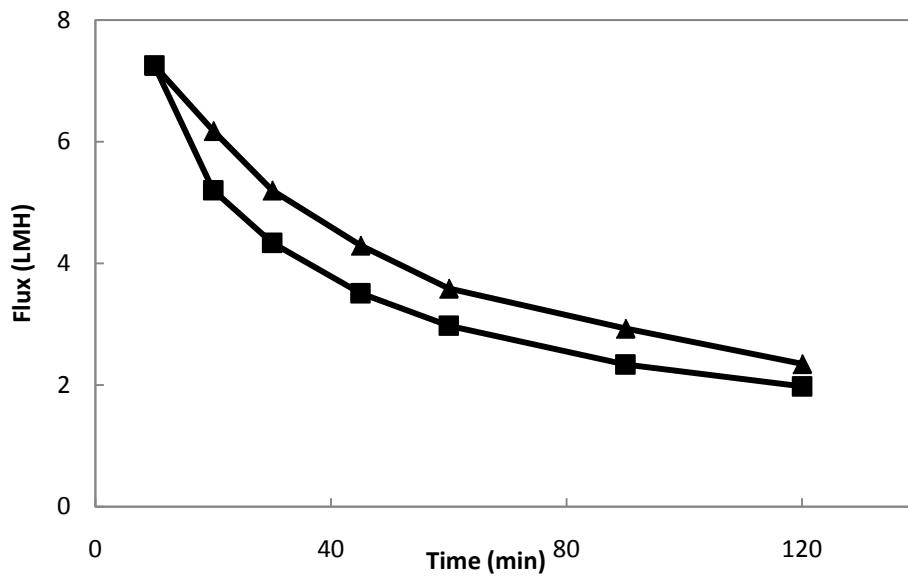

Figure 5.19 Effect of feed concentration on flux during EMF of PLA and LP (■)19.1g/L
(▲)10.2g/L

By using Batch A, the permeate flux from both cases was nearly two-fold higher than that obtained from Batch B as Figure 5.16 shows. The flux decreased gradually with time, as expected permeate flux obtained when EMF of less concentrated feed solution was higher than that obtained when dealing with more concentrated solution. This was due to thicker layer built up on the membrane surface when more concentrated solution was used, thereby the flux decreased.

Transmissions of PLA and LP were also compared between these two experiments in Figure 5.20.

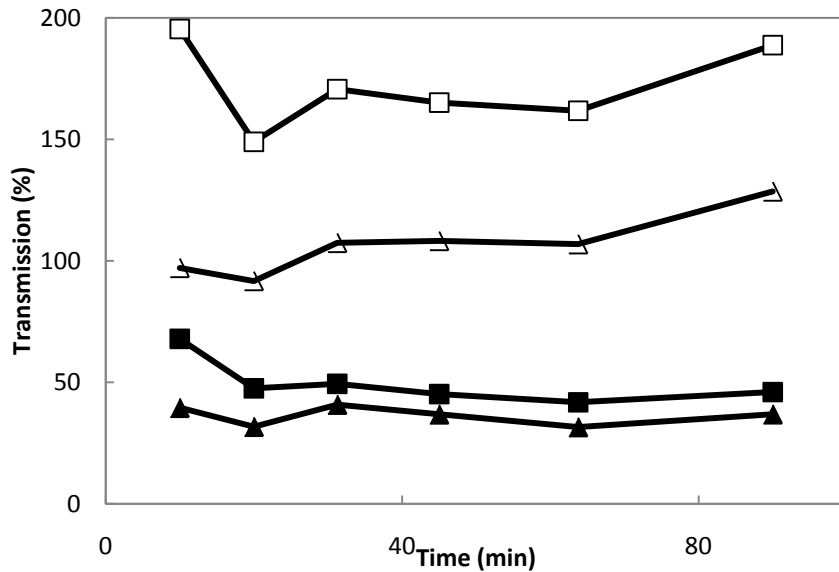

Figure 5.20 Effect of feed concentration on transmission during EMF of PLA and LP (■)PLA, 19.1g/L (□)LP, 19.1g/L (▲)PLA, 10.2g/L (Δ)LP, 10.2g/L

As seen in Figure 5.20, by increasing the total feed concentration, transmissions of both PLA and LP increased. A maximum 2-fold factors increase of LP transmission was obtained when EMF of high feed concentration at the beginning of the experiment. The increase of PLA transmission was very little. This can be explained by the mentioned extended Nernst-Planck equation. By increasing the feed concentration, transport rate of the negatively charged LP increased due to the increase of convective and electric transport. Regarding the transmission of LP, it seemed that the increased electric transport away from membrane was not strong enough to compete with the increased convective transport.

The solute flux which describes the transport rate of PLA and LP is presented in the following Figure.

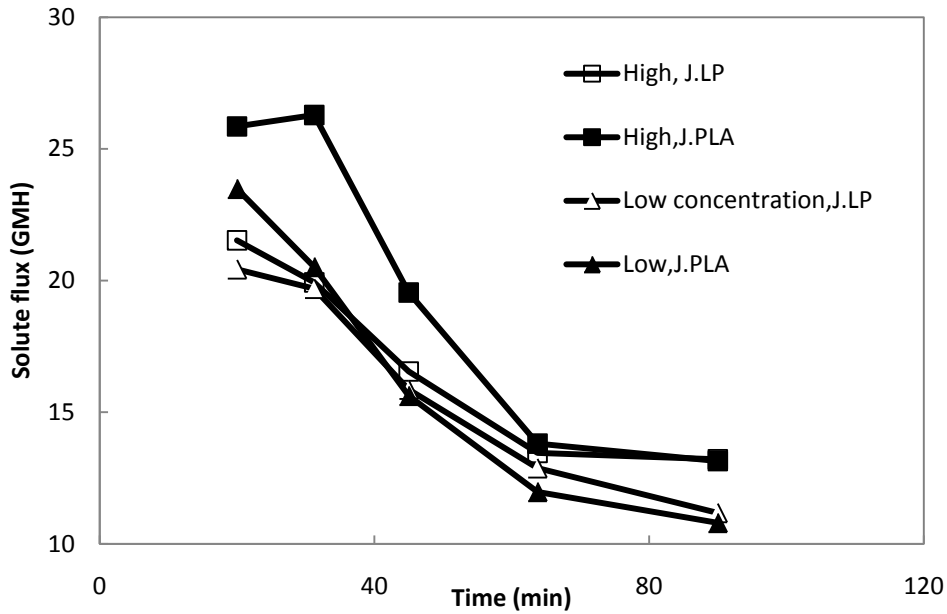

Figure 5.21 Effect of feed concentration on solute flux of PLA and LP during EMF operation
 (■)PLA, 19.1g/L (□)LP, 19.1g/L (▲)PLA, 10.2g/L (Δ)LP, 10.2g/L

A slight higher solute flux for both PLA and LP was obtained when EMF of high concentration feed solution, which is expected that a proportional increase of the transport rate with concentration is according to the ENP equation. Bargeman et al. [103] reported a 2.1-fold increase in the amount of bioactive peptide transported during 4 hours of EMF operation when the feed concentration of casein hydrolystate increased from 0.8 to 2g/L. Solute flux for all cases decreased, which could be due to the decrease of permeation flux and also to the decrease of electric field strength in feed compartment during the experiments. The difference of transport rate between high and low concentration feed for EMF was very small. The average transport rate for PLA and LP during the 2 hours experiment was 19.7 GMH and 16.9 GMH respectively for high concentration feed, and 16.5 GMH and 16 GMH for low concentration feed. This observed minor difference in the amount of PLA and LP transported for both high and low concentration feed can be partly explained by the difference of electric field strength in the feed compartment caused by the difference of feed conductivity. As a result of relative lower feed conductivity of the feed in low feed concentration, the electric field strength in the feed compartment as driving force was expected to be bit higher than for the higher concentration solution. This will slightly counteracted the positive effect of the higher concentration on the amount of LP transported.

The following Figure 5.22 shows the comparison of selectivity obtained between high and low feed concentrations.

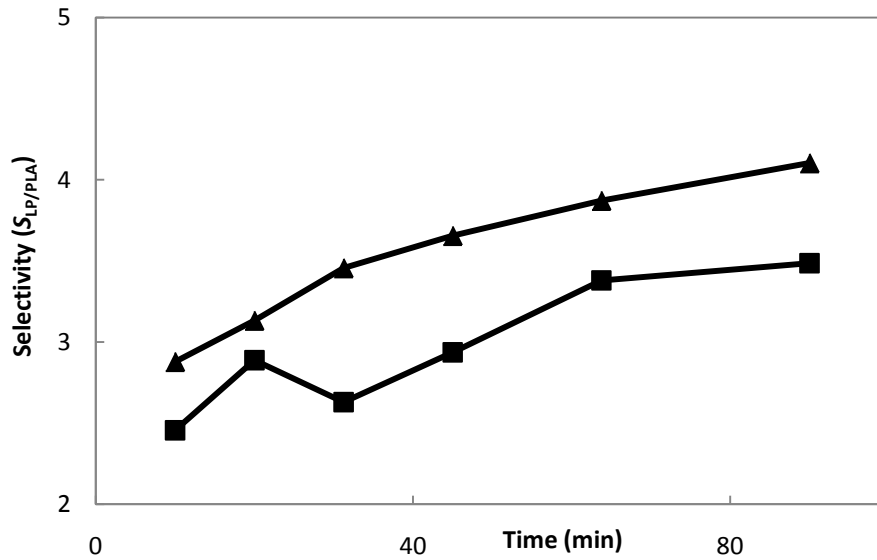

Figure 5.22 Effect of feed concentration on selectivity during EMF of PLA and LP (■)19.1 g/L (▲)10.2 g/L

Selectivity in both cases increased gradually with time. By decreasing the feed concentration, separation performance improved, which was probably ascribed to less fouling when dealing with less concentrated feed solution.

The following Table summarized the comparison of selectivity and LP purity at the start and at end of each experiment. It clearly shows that both selectivity and LP purity increased when the feed concentration decreased.

Table 5.2 Summary of experimental conditions and comparison of separation performance in terms of selectivity and LP purity obtained at different feed concentration during EMF operation

Experiment	pH	Feed concentration (g/L)	Percentage of LP concentration in feed(%)	Selectivity		Permeate LP purity (%)	
				10min	90min	10min	90min
-MF+,0.35bar,1364V/m	5	19.1	22.4	2.46	3.49	41.45	50.13
-MF+,0.35bar,1364V/m	5	10.2	21.7	2.88	4.10	44.42	53.26

An investigation of the effect of PLA concentration in the feed was performed. By decreasing the PLA concentration and keeping the LP concentration almost constant in the feed did not help improve the separation performance (data not shown).

5.3.3.1.2.3 Batch variation

An investigation of Batch variation on separation performance was also carried out. One of the main reasons was that PLA Batch A product has almost run out, therefore it was essential to know whether there will be any effect that Batch B might have on the separation performance in EMF.

The effect of PLA batch variation on flux during EMF separation of PLA and LP is presented Figure 5.23.

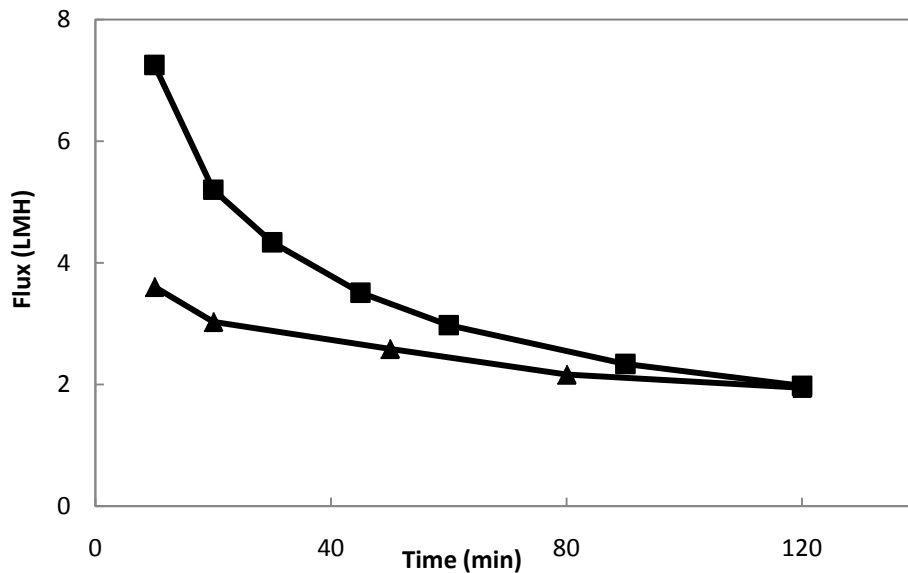

Figure 5.23 Effect of PLA batch variation on permeate flux during EMF of PLA and LP (■)Batch A (▲)Batch B

When using Batch A PLA in the separation experiment, the permeate flux at beginning of experiment was nearly 2-fold factors higher than when using Batch B. Permeate flux in both cases decreased with the time. Even though the decline rate when dealing with Batch A was bigger than with Batch B, the permeate flux at the end of each experiments ended up with the same value. One of the reasons for the different flux pattern could be that the viscosity and conductivity between Batch A and Batch B were different.

The PLA batch variation on transmission was also investigated and the results are shown in Figure 5.24.

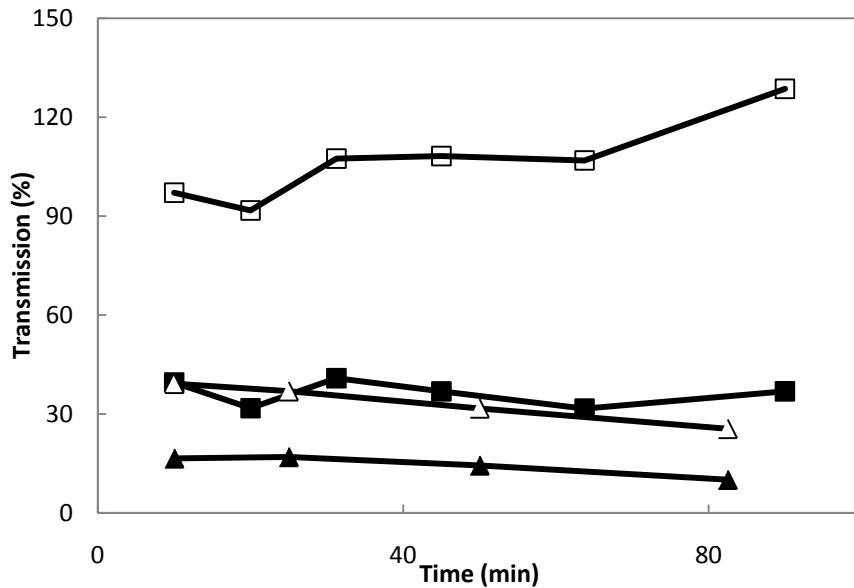

Figure 5.24 Effect of PLA batch variation on transmissions during EMF of PLA and LP (■)Tr. of PLA, Batch A (□) Tr. of LP, Batch A (▲) Tr. of PLA, Batch B (△) Tr. of LP, Batch B

The transmissions of PLA and LP shows different when different PLA batches were used. Both PLA and LP transmissions increased when PLA Batch A was used. More significant effect was observed on the LP transmission when PLA Batch A was used, the transmission of LP increased by nearly 3-fold factors. The increase of transmission was probably due to less membrane fouling and higher electric field strength in feed compartment when using PLA Batch A. The changes of membrane-protein and protein-protein interaction can also be the reason for the transmission variation.

Figure 5.25 compares the PLA and LP solute fluxes obtained between using PLA Batch A and Batch B.

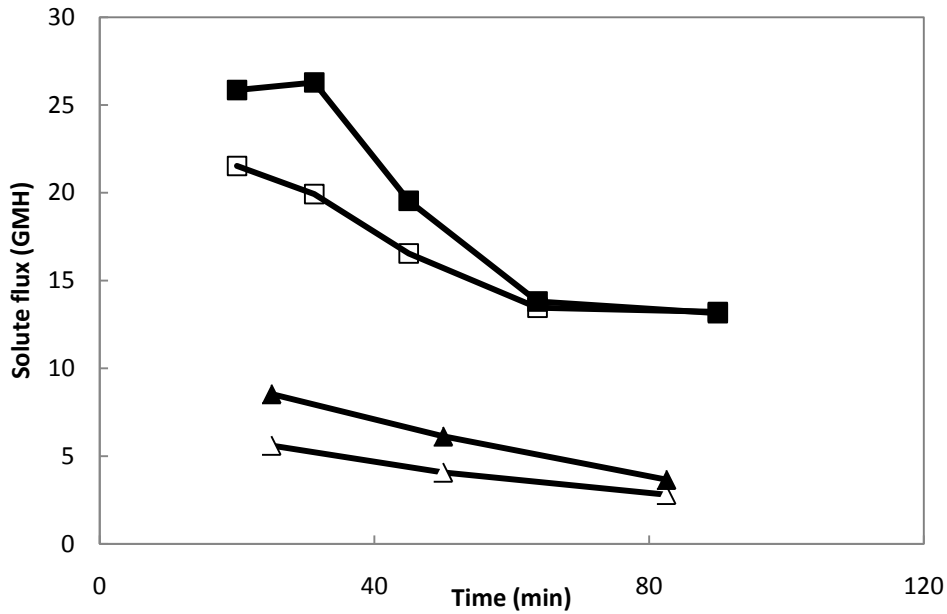

Figure 5.25 Effect of PLA batch variation on solute flux during EMF of PLA and LP (■)PLA, Batch A (□)LP, Batch A (▲)PLA, Batch B (△)LP, Batch B

Obviously, the solute flux was also influenced very much by the PLA Batch variation. Solute flux of both PLA and LP increased more than 2 times when PLA Batch A was used. The increase of solute flux can be due to higher permeate flux during EMF when using PLA Batch A. Solute flux in both cases decreased with time and the decrease patterns were similar with that of permeate flux as Figure 5.23 shows.

Figure 5.26 illustrates the effect of PLA batch variation on separation performance in terms of selectivity.

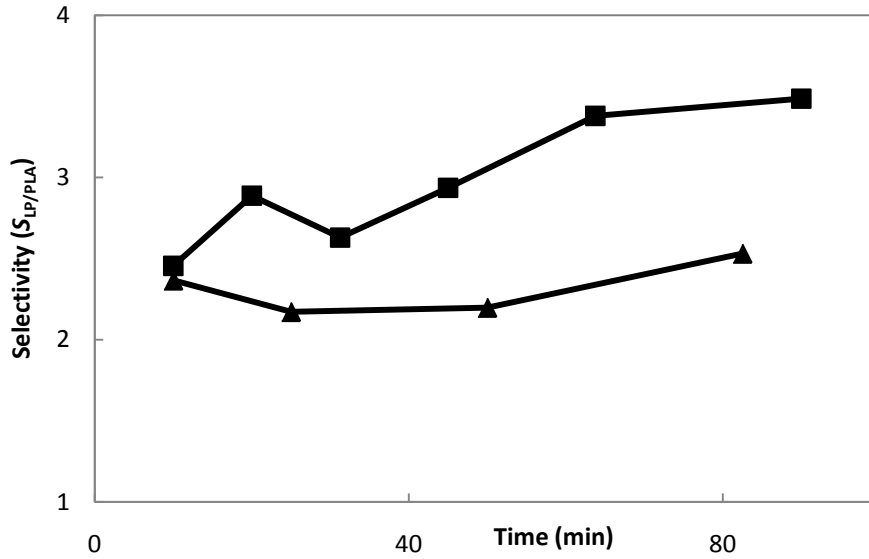

Figure 5.26 Effect of PLA batch variation on selectivity during EMF of PLA and LP (■)Batch A (▲)Batch B

By using PLA Batch A in the separation, selectivity could be achieved more than 3, which was higher than that obtained from Batch B.

All the results with respect to the effects of PLA batch variation on permeate flux, transmission and solute flux prove that effect of batch variation should be taken into account. Therefore, it is important to keep the record of using different batches in the experiments.

Table 5.3 summarized the selectivity and LP purity improvement during each experiment by using PLA Batch A and PLA Batch B.

Table 5.3 Summary of experimental conditions and comparison of separation performance in terms of selectivity and LP purity obtained during EMF of PLA and LP with different PLA batches

Experiment	pH	Feed concentration (g/L)	Percentage of LP concentration in feed(%)	Selectivity		Permeate LP purity (%)	
				10min	82.5-90min	10min	82.5-90min
-MF+,0.35bar,1364V/m	5	19.1 (Batch A)	22.4	2.46	3.49	41.45	50.12
-MF+,0.35bar,1364V/m	5	21.4 (Batch B)	23.2	2.37	2.53	44.67	43.34

5.3.3.2 Cellulose based membrane

The water permeability of the above used PS membrane after chemical cleaning remained at 140 ± 20 L/(m².h.bar) at 20 degrees, which is rather low as compared to typical water permeability obtained from MF. The reason for that was probably due to its rather low porosity (around 12%) [114] and low ability of fouling resistance. Even though it has shown that separation of PLA and LP can be achieved with maximum selectivity around 5 with this PS membrane, from productivity point of view it is not attractive to use this membrane with such low permeate flux.

Therefore, a Hydrosart membrane purchased from Sartorius was tested on the application of EMF of PLA and LP. In this part, first the comparison of MF separation of PLA and LP using GRM and Hydrosart membrane was performed in order to understand the membrane itself. Then investigations of the feed pH, electric field strength and TMP on the EMF separation performance were carried out. All the PLA solution used in this part was from PLA Batch B.

5.3.3.2.1 Hydrosart membrane in MF and EMF filtration

The water permeability of Hydrosart membrane was above 10000 L/ (m².h.bar) at 20 degrees, which was 2 orders of magnitude higher than the PS membrane. Figure 5.27 illustrates the comparison of flux obtained during MF separation of PLA and LP with GRM and Hydrosart membrane.

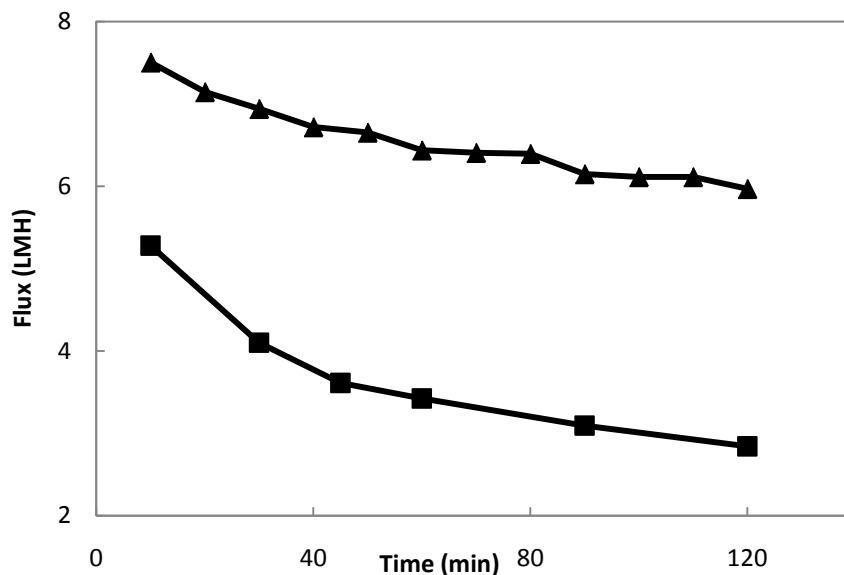

Figure 5.27 Comparison of the flux obtained during MF of PLA and LP using GRM and Hydrosart membrane (■)GRM (▲)Hydrosart; experiments ran at the same conditions, feed concentration 21.5g/L(PLA Batch B+LP) with 22.5% LP 25mM NaOAc, pH 5, TMP 0.35bar, 50mM Na₂SO₄ as initial permeate solution

Even though the water permeability of Hydrosart membrane was 2 orders of magnitude higher than that of GRM membrane, the permeate flux during MF filtration of 21.5g/L enzyme solution was not proportionally higher. The permeate flux started at around 7.5 LMH and gradually decreased to 6 LMH. Higher permeate flux was obtained by using Hydrosart membrane, but the difference was not so big.

The permeate concentration of PLA and LP in these two membranes were also compared and the data are shown in the following Figure.

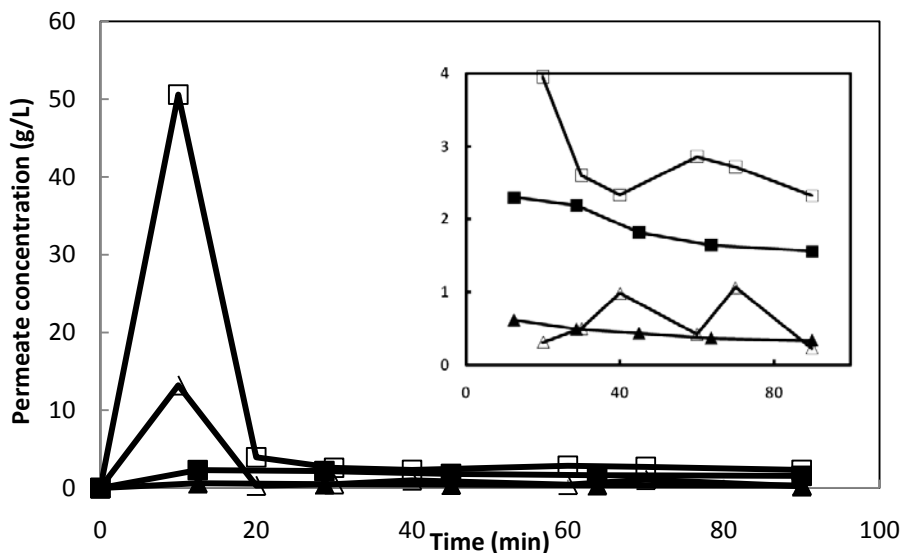

Figure 5.28 Comparison of the measured permeate concentration of PLA and LP as function of time during MF of PLA and LP using GRM and Hydrosart membrane (■)PLA, GRM (□)PLA, Hydrosart (▲)LP, GRM (△)LP, Hydrosart; experiments ran at the same conditions, feed concentration 21.5g/L(PLA Batch B+LP) with 22.5% LP 25mM NaOAc, pH 5, TMP 0.35bar, 50mM Na₂SO₄ as initial permeate solution

As can be seen in Figure 5.28, the permeate concentration of PLA and LP as function of time shows different pattern with the two membranes especially at the beginning of experiments. In Hydrosart membrane, the permeate concentration of PLA and LP increased dramatically at beginning (around

50g/L and 13g/L respectively) and then decreased rapidly to a very low level. The rapid increase of permeate concentration at beginning was probably due to the higher porosity of Hydrosart membrane, after a few minutes the membrane was heavily fouled and the pore size was constricted therefore resulted in dramatic decrease of permeate concentration. However, it is still unclear how the permeate concentration reached higher than the bulk concentration in absence of other driving forces other than convective transport. In the GRM membrane, the permeate concentration of PLA and LP remained at low and stable level due to its original low porosity. The transmissions of PLA and LP in Hydrosart membrane at beginning were more than 300% may suggest that rate of solute transport was higher than the rate of solvent transport.

By looking at the flux and permeate concentration change for both of the two membranes, it can be found that due to the high porosity of the Hydrosart membrane, the transport of both PLA and LP was very high at beginning, but then due to the severe membrane fouling the membrane started acting like GRM membrane.

One experiment ran with electric field was carried out in order to investigate how this membrane acts in application of separation. The experiment was performed with feed solution at concentration 21.3g/L (PLA Batch B+LP) with 22.2% LP and 25mM NaOAc, pH 5, TMP 0.26bar, constant electric field strength 1364 V/m.

The permeate flux, solute flux and selectivity are shown in the following Figures.

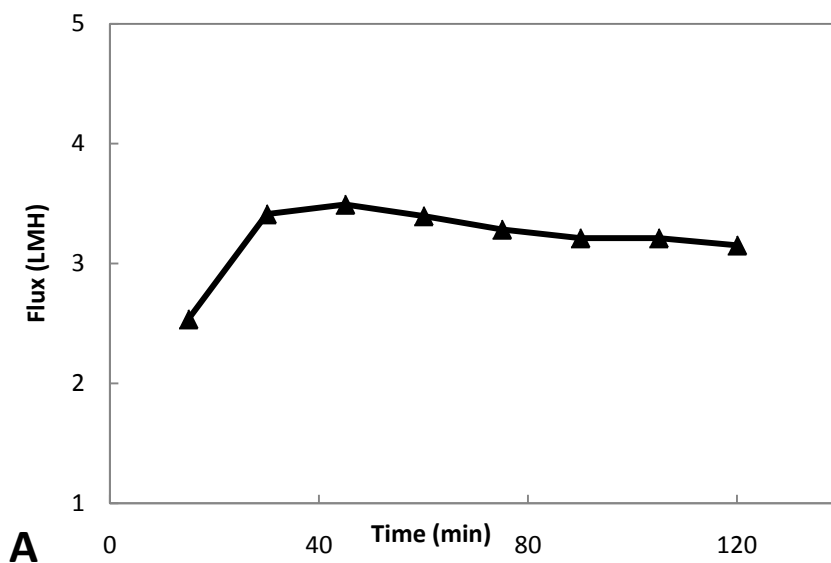

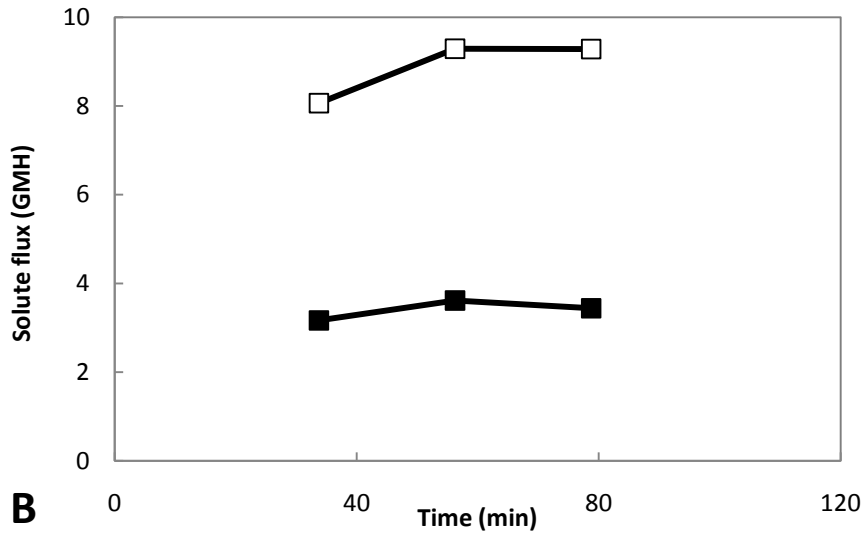

Figure 5.29 (A) Permeate flux and (B) solute flux of the two enzymes during EMF (■)LP (□)PLA

There was no improvement of permeate flux by using Hydrosart membrane, it stayed at quite low level. However, in comparison to GRM membrane, the permeate flux was more constant during the experiment. It is still hard to understand whether the constant flux was resulted from the low operation TMP or its low fouling property. With respect to solute flux, as shown in Figure 5.29 (B), the amount of PLA transported into permeate was nearly 4 times more than that of LP, which was due to the higher concentration of PLA in the feed even though there was additional driving force from electric field acting on LP besides the convective transport. The solute flux of both PLA and LP also remained very constant. The transmissions of PLA and LP in this case were also constant suggesting that the Hydrosart membrane has more ability to prevent protein fouling than GRM membrane.

Figure 5.30 shows the selectivity change during the experiment.

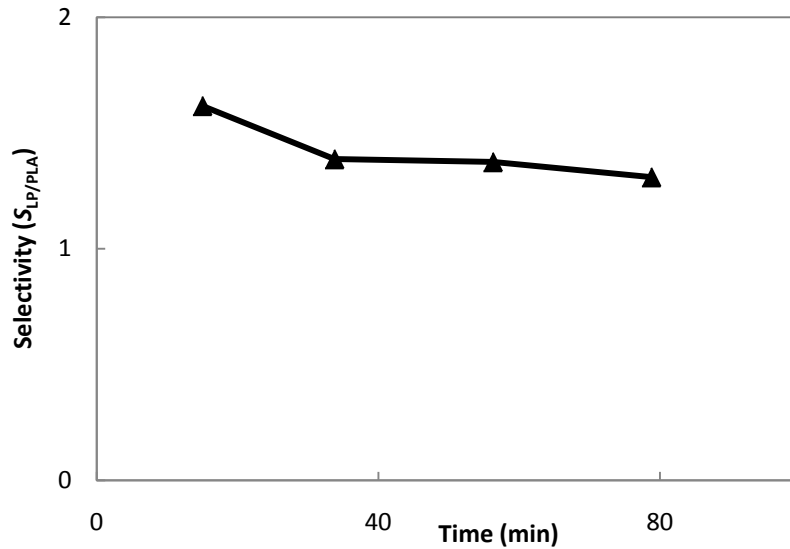

Figure 5.30 Selectivity obtained during EMF of PLA and LP

As seen in the Figure, selectivity obtained during the experiment was above unity, which indicated that separation of PLA and LP was possible to achieve. However, in comparison to the selectivity obtained with GRM membrane, it was bit lower. It is hard to know how the separation performance is related with the membrane itself. In the later sections, experiments were carried out to find the parameters that influence the separation performance and to understand how they affect the separation performance.

5.3.3.2.1.1 Effects of CaCl_2 addition in the feed and buffer concentration

We were suggested by the internal scientists that the enzymes shall have certain amount of calcium ion in the solution in order to have stable activity. That was also the reason why precipitation happened more often in the PLA Batch B solution due to the shortage of calcium resulted from diafiltration. Therefore, in the further investigation all the feed solution was added 10mM CaCl_2 .

The effect of CaCl_2 addition was studied by comparing two EMF filtration experiments ran at the same conditions one with CaCl_2 and the other without CaCl_2 in the feed solution. The experiments were run at similar conditions: feed concentration 20.8g/L with 22.5%LP and 25mM NaOAc, pH 5.5, TMP 0.26bar, constant electric field 1364V/m. The experiments were performed for 2 hours. The results were shown by comparing the average permeate flux, average transmissions of PLA and LP, average selectivity, average LP purity in permeate and also the current, feed conductivity evolution between the two experiments.

As can be seen from Table 4, experiment performed without CaCl_2 in the feed allowed higher transmissions of PLA and LP thus resulting bit higher selectivity. By adding CaCl_2 , the zeta-potential of the enzyme solution representing the surface charge of the enzyme particle will decrease, thereby the effect of electric field will decrease. This phenomenon was observed in the case of LP transmission, the average transmission of LP decreased from 150.2% to 65.7% due to the addition of 10mM CaCl_2 . However, the results for PLA transmission change were not in accordance with the theory, average transmission of PLA decreased by adding 10mM CaCl_2 . It is expected that the effect of electric field dragging PLA away from membrane should decrease thereby an increase transmission can be obtained. The reasons for the decrease of PLA transmission was probably because of membrane fouling due to the calcium and its interaction with LP. And this was also be proved by the fact that the water permeability was not possible to be restored to the same level as it has before each experiment, even after chemical cleaning with several rounds of caustic and acid treatment. The decrease of transmission can also be attributed to the higher conductivity in the feed, with higher conductivity in feed the utilization of the same current by enzyme will decrease. Marshall *et al.* [151] also reported that the fouling resistance of a microfiltration membrane increased when calcium was added into a β -lactoglobulin solution, especially at high flux rate. The permeate flux increased from 3.2 to 4.7LMH by adding CaCl_2 . We do not know if this was due to electro-osmosis effect.

Table 5.4 Summary of the results from the experiments performed with and without addition of CaCl_2 during EMF of PLA and LP

Addition of CaCl_2	Flux (LMH)	Current (A)	Feed conductivity (us/cm)	Tr of PLA (%)	Tr of LP (%)	Permeate LP purity (%)	Selectivity
None	3.2	2.81-1.22	2630-1932	75.3	150.2	36.6	2
10mM	4.7	3.62-1.11	4030-2940	46.4	65.7	29.8	1.4

The effect of buffer concentration in the feed was also studied (Figures not shown). Two experiments carried out at the same conditions but with concentration of NaOAc (one with 25mM and the other with 50mM): concentration of feed solution 21g/L (PLA+LP) with 21% LP, pH 5, TMP 0.26, electric field strength 1364V/m. Results showed that a 1.9-fold increase of average permeate flux was obtained by increasing the NaOAc buffer concentration from 25mM to 50mM during 2 hours EMF filtration experiments. Correspondingly, a 2-fold and a 1.7-fold increase of

average PLA and LP solute flux were obtained respectively. The reason for the increase of permeate flux could be due to the solubility increase of enzymes and to the low viscosity at relative high conductivity. As a result of lower conductivity (25mM), the electric field strength in the feed compartment was 1.1 factors higher than for the higher conductivity (50mM). This slightly counteracted the positive effect of higher convective transport of LP.

The selectivity was almost the same between the two cases indicating the separation performance was not influenced by the buffer concentration. However, if energy consumption is taken into account, one should avoid high salt conductivity.

5.3.3.2.1.2 Effect of solution pH

The effect of pH is directly related to protonation and deprotonation phenomenon thus the charge of protein, which is pH dependent as shown in Figure 5.3. According to Figure 5.3, at the pH range 4.7-7.7, PLA becomes less positively charged and LP becomes more positively charged when the pH stays more away from pH 4.7. There should be an optimal pH, at which the ratio of LP and PLA transmission is maximum resulting in the best separation.

Three experiments carried out at almost the same conditions, constant TMP 0.26bar, constant electric field strength 1364V/m, but with different pH of feed solution, feed solution in all cases contained 25mM NaOAc and CaCl₂ in order to keep pH constant and enzyme active. The experimental conditions are summarized in the following Table.

Table 5.5 Summary of experimental conditions during EMF of PLA and LP at different feed pHs

pH	TMP (bar)	Electric field strength(V/m)	Feed concentration(g/L)	% of LP concentration in feed
5	0.26	1364	21.8	8.3
5.25	0.26	1364	22.2	8.9
5.5	0.26	1364	22.2	8.7

Figure 5.31 shows the effect of solution pH on permeate flux when EMF filtration of PLA and LP.

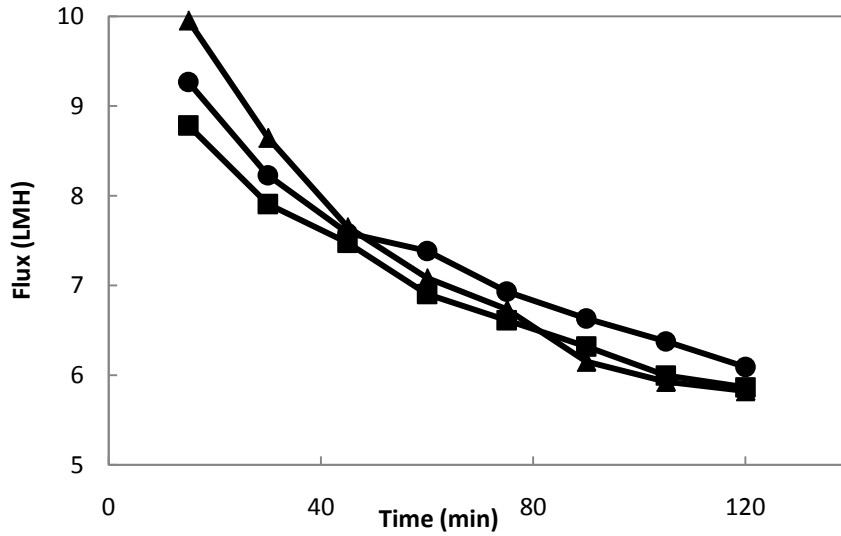

Figure 5.31 Comparison of the permeate flux obtained at different feed pHs during EMF of PLA and LP (■)pH 5(●)pH 5.25(▲)pH 5.5

The permeate flux at the very beginning of each experiment increased with the increase of solution pH, but the difference was very small in the investigated pH range. The permeate flux declined gradually with the time, at the end of experiments, it reached at around 6LMH in all the cases. With the time progresses, the pH effect on permeate flux was very little. The slight increase of permeate flux at the start with the increase of pH can be due to protein-membrane interaction change, which might result in less fouling.

The transmissions of PLA and LP obtained at different feed pH were compared in Figure5.32.

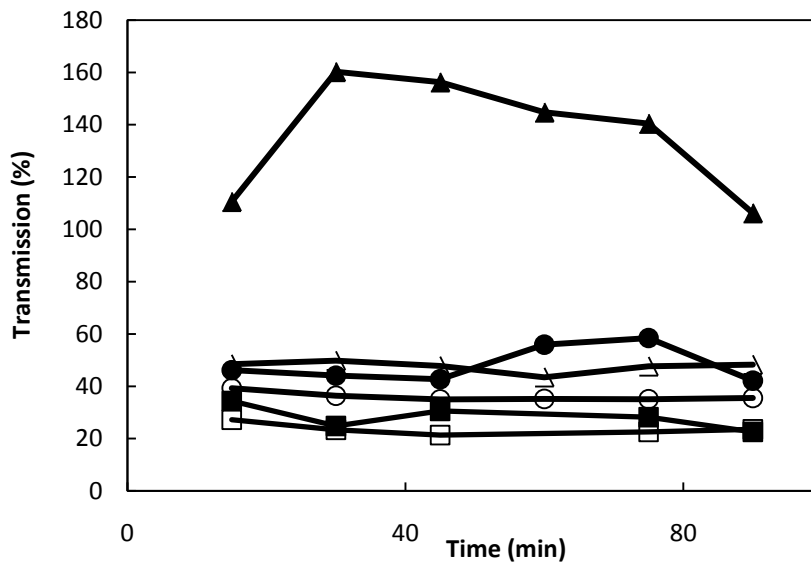

Figure 5.32 Comparison of the transmissions of PLA and LP obtained at different feed pHs during EMF of PLA and LP (■)Tr LP, pH 5(□)Tr PLA, pH 5 (●)Tr LP pH 5.25 (○) Tr PLA pH 5.25 (▲)Tr LP, pH 5.5(△) Tr PLA, pH 5.5

The transmissions of both PLA and LP increased with the increase of pH. This was the most evident for the LP transmission when the pH was at 5.5. As the pH increases, LP becomes more negatively charged; therefore the electro-transport towards membrane will be enhanced. The reason why LP transmission increased rapidly when increasing from pH 5.25 to pH 5 can be due to the charge density increase is more pronounced in this range and to the decrease of friction between membrane pore and LP. Regarding the PLA transmission, it can be explained by the fact that PLA becomes less positively charged with the increase of pH, the effect of electric field strength on electro-transport of PLA decreased thereby the transmission increased with the increase of pH.

The solute flux of PLA and LP at different pHs is presented in Figure 5.33.

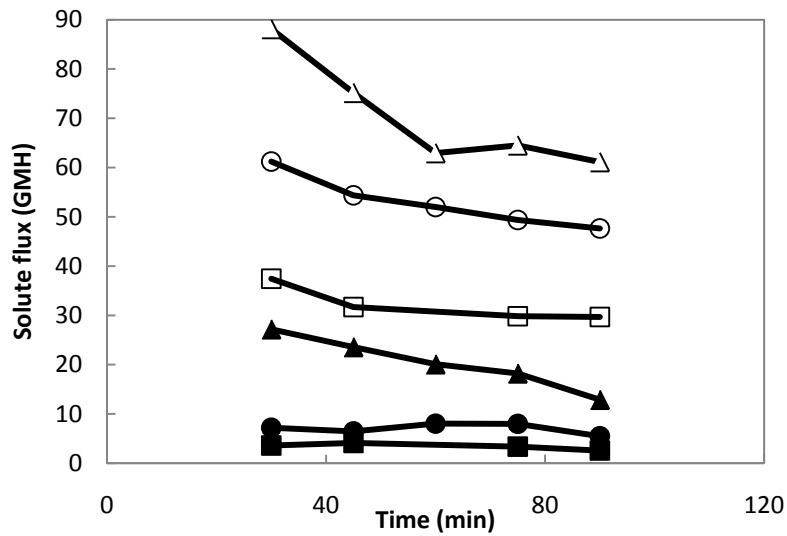

Figure 5.33 Comparison of solute fluxes of PLA and LP obtained at different feed pH s during EMF of PLA and LP (■) LP, pH 5 (□) PLA, pH 5 (●) LP pH 5.25 (◊) PLA pH 5.25 (▲) LP, pH 5.5 (△) PLA, pH 5.5

The solute flux of both PLA and LP also increased with the increase of pH which shows the similar variation pattern of transmission. The solute flux of PLA in all the cases was higher than that of LP, which was due to the higher concentration of PLA in the solution than LP. As the pH increases, LP becomes more negatively charged; therefore the electro-transport towards membrane will be enhanced. Since the convective transports were more or less the same at the investigated pH range, the amount of LP transported shall be enhanced due to the enhanced electro-transport (according to the ENP equation). Regarding the PLA transmission, it can also be explained by the ENP equation. PLA becomes less positively charged with the increase of pH, therefore the effect of electric field strength on electro-transport of PLA decreased. Since the convective transport of PLA remained constant (permeate fluxes were the same in the investigated pH range as Figure 5.31 shows and feed concentrations of PLA were the same) and electro-transport was in an opposite direction to convective transport, therefore the total PLA solute flux increased with the increase of pH.

Figure 5.34 illustrates the comparison of selectivity change during EMF filtration at different feed solution pH.

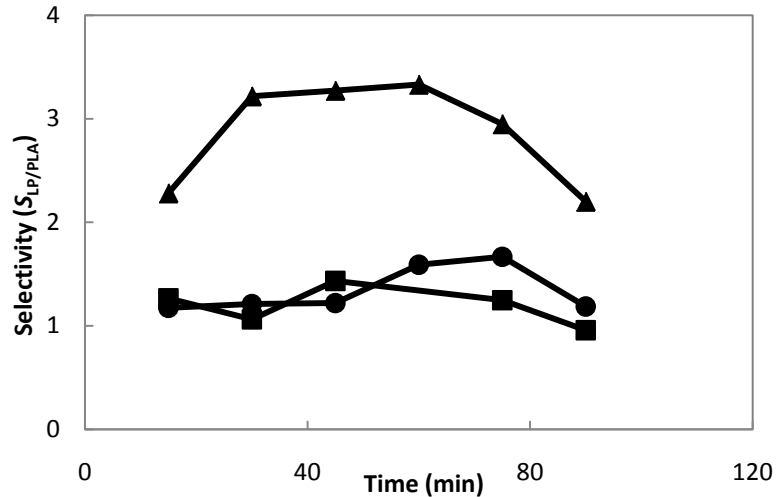

Figure 5.34 Comparison of the selectivity obtained from different feed pHs during EMF of PLA and LP (■)pH 5(●)pH 5.25(▲)pH 5.5

It can be clearly seen that the selectivity remained almost the same when increasing pH from 5 to 5.25. Then there was a great increase when pH was increased to 5. This observation was related to the PLA and LP transmission behavior as Figure 5.32 shows. The LP transmission increased much faster than that of PLA when pH was lifted up to 5.5. In order to have high selectivity, one shall try to maximize the LP transmission and minimize the PLA transmission. Adjustment of solution pH is obviously an option to do that.

5.3.3.2.1.3 Effect of electric field strength

Two experiments were performed to investigate the effect of electric field strength on the separation performance. By increasing the electric field strength, the electrotransport shall be enhanced. Dependent on the molecular charge, one can expect either an increase or decrease of the amount of solute transported. The two experiments were run at 1364 and 2046 V/m respectively with keeping other conditions almost the same, feed solution in both cases contained 25mM NaOAc and 10mM CaCl₂ in order to keep pH constant and enzyme active. Details of the experimental conditions are presented in the following Table.

Table 5.6 Summary of experimental conditions during EMF at different electric field strength

Electric field strength(V/m)	TMP (bar)	pH	Feed concentration(g/L)	% of LP concentration in feed
1364	0.26	5	21.8	8.3
2046	0.26	5	22.5	8.3

Figure 5.35 shows the permeate flux obtained at two different electric field strength during EMF filtration.

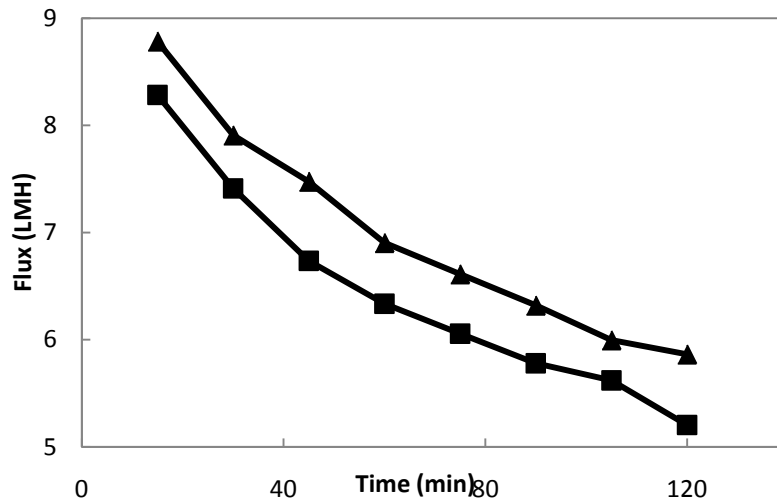

Figure 5.35 Comparison of permeate flux obtained at different electric field strength during EMF separation of PLA and LP (■) 2046 V/m (▲) 1364 V/m

The permeate flux decreased slightly when electric field strength was increased from 1364 to 2064V/m. This can be due to the increase of viscosity when increasing the electric field strength. This was in agreement with the studies done by Andrade et.al [149] who reported that the solution viscosity was increased in the presence of electric field and this effect increased with increasing the strength of electric field. As expected, the permeate flux decreased with the time due to membrane fouling.

The transmissions of PLA and LP during EMF filtration at different electric field strength were compared in Figure 5.36.

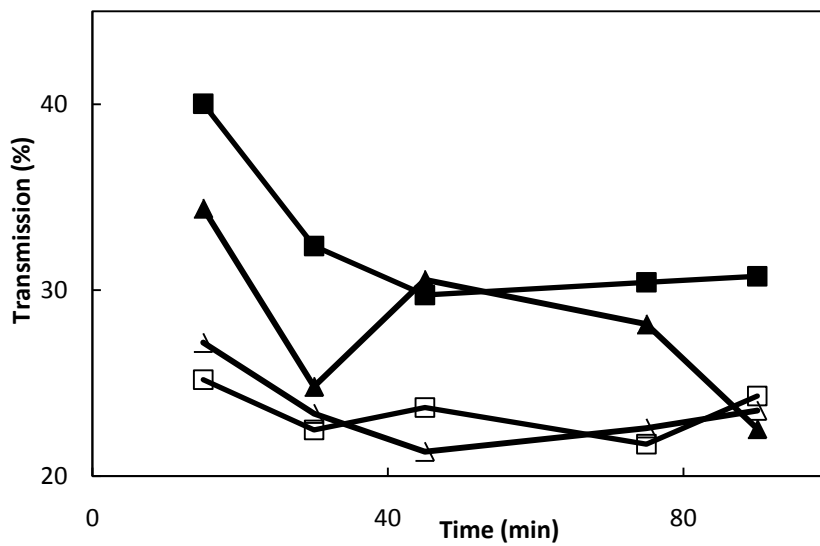

Figure 5.36 Comparison of the transmissions of PLA and LP obtained at different electric field strength during EMF of PLA and LP (■) LP, 2046V/m (□) PLA, 2046V/m (▲) LP, 1364V/m (△) PLA, 1364V/m

As can be seen in Figure 5.36, the increase of LP transmission was very little by increasing the electric field strength. This was probably due to the increase of membrane resistance resulted from the increase of driving force. There is probably a critical electric field strength below which the transmission of LP increases greatly with its increase and above which the transmission of LP increases very little. Therefore, control the membrane fouling of enzyme deposition resulted from the electrophoretic driving force should be taken into account. The transmission of PLA remained almost the same when the electric field strength was increased, which seemed illogical because one shall expect that by increasing the electric field strength the transmission should be decreased. A possible explanation could be that the critical electric field has been reached therefore the bulk concentration is higher than the concentration on membrane surface, which results diffusion towards membrane. Again, the friction of LP on PLA can also enhance the transmission. Another explanation could be that the current efficiency was quite low in the relative high conductivity solution. This was reflected from the observation that solute fluxes of both PLA and LP were almost not affected as Figure 5.37 shows.

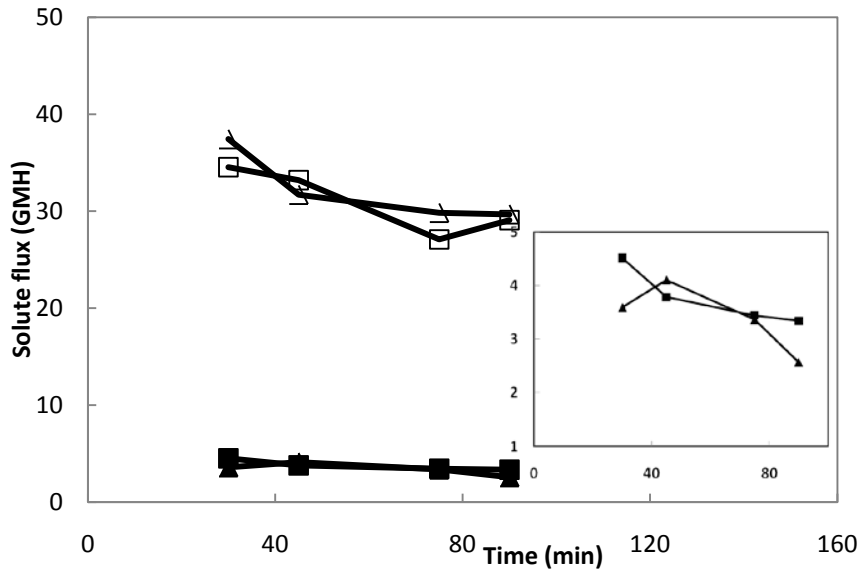

Figure 5.37 Comparison of the solute fluxes of PLA and LP obtained at different electric field strength during EMF (■) LP, 2046V/m (□) PLA, 2046V/m (▲) LP, 1364V/m (△) PLA, 1364V/m

As expected, the solute flux of LP was more than 5-fold factors lower than that of PLA due to higher concentration of PLA in the feed. However, the solute fluxes of both PLA and LP did not increase with the increase of electric field strength. Obviously, the increase of electric field strength did not help as expected. Theoretically, by increasing the electric field strength the solute flux should be increased when electrotransport is in the same direction of convective transport, and vice versa. This can be due to the increased part of current was mainly utilized by other ions in the solution since the conductivity in the feed was nearly 4ms/cm. The concern of enzyme denaturation should be ruled out because the activity was checked during the experiment and no activity loss was discovered.

Due to the slightly increase of PLA transmission, selectivity was also improved slightly when the electric field strength was increased as the following Figure shows.

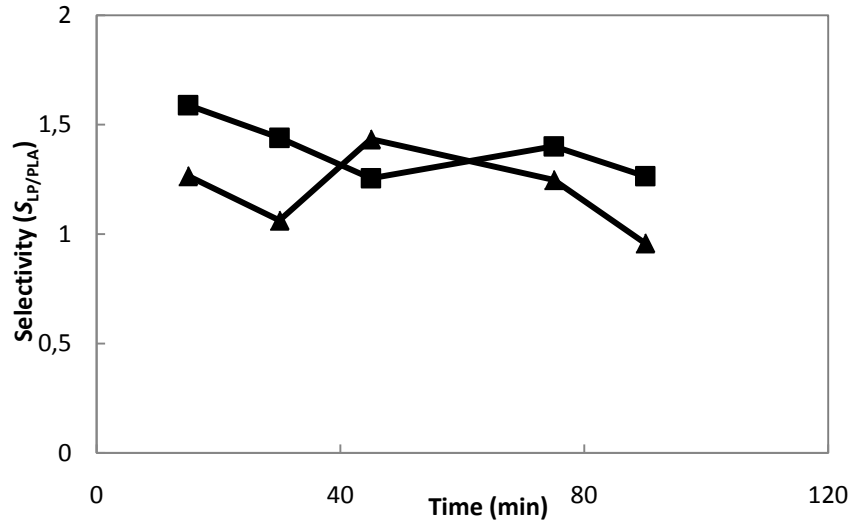

Figure 5.38 Comparison of the selectivity obtained at different electric field strength during EMF
(■) 2046 V/m (▲) 1364 V/m

As can be seen, average selectivity increased slightly by 14% when the electric field was increased from 1364 to 2056 V/m, which was not attractive at all. Over this investigated range, the increase of electric field did not help improve the separation so largely. This can be due to the low current efficiency at relatively high conductivity of feed. In this sense, it is waste of energy to increase the electric field strength.

5.3.3.2.1.4 Effect of TMP

The effect of TMP is more complex when electric field is in present compared to conventional UF and MF filtration. Two experiments were performed to investigate the effect of TMP on the separation performance. The two experiments were run at 0.26bar and 0.35bar respectively with keeping other conditions almost the same, feed solution in both cases contained 25mM NaOAc and 10mM CaCl₂ in order to keep pH constant and enzyme active. Details of the experimental conditions are presented in the following Table.

Table 5.7 Summary of experimental conditions performed at different TMP

TMP (bar)	Electric field strength(V/m)	pH	Feed concentration(g/L)	% of LP concentration in feed
0.26	2046	5	22.5	8.3
0.35	2046	5	22.4	8.5

Figure 5.39 illustrates the flux obtained at two different TMP during EMF filtration.

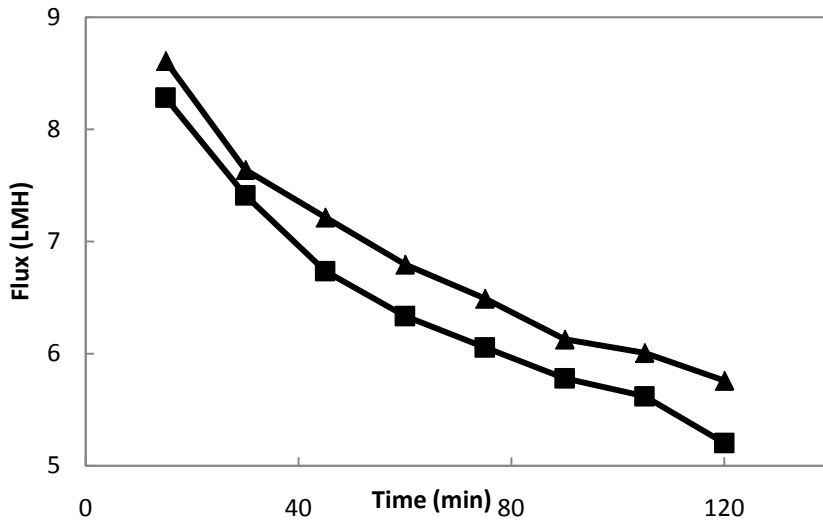

Figure 5.39 Comparison of the permeate flux obtained at different TMP during EMF of PLA and LP (■) 0.26bar (▲) 0.35bar

As expected, the permeate flux increased slightly when the TMP was increased. Obviously, the limiting flux was not reached yet at 0.35bar. In both cases, the permeate flux decreased gradually with the time in a similar pattern.

The transmissions of PLA and LP were also compared between the two operating TMP. The data are shown in the following Figure.

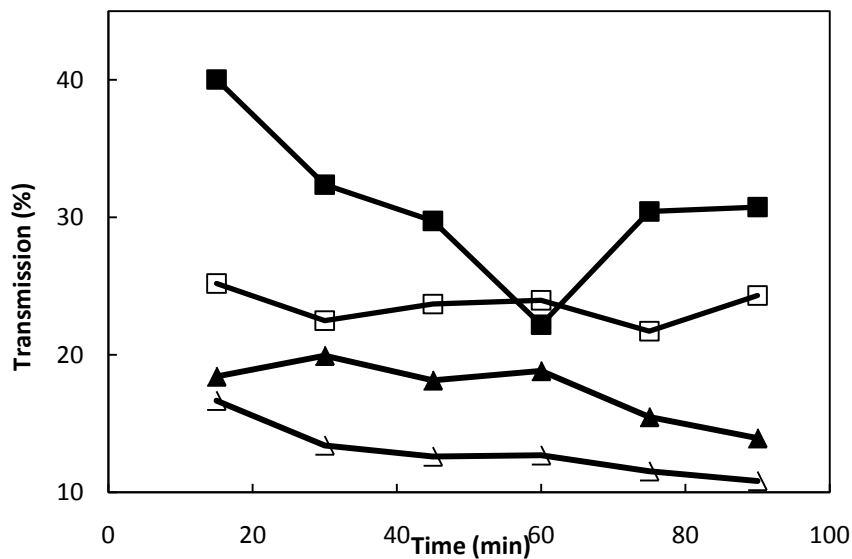

Figure 5.40 Comparison of the transmissions of PLA and LP obtained at different TMP during EMF of PLA and LP (■) LP, 0.26bar (□) PLA, 0.26bar (▲) LP, 0.35bar (△) PLA, 0.35bar

Surprisingly, the transmissions of both PLA and LP were not enhanced by increasing the TMP from 0.26bar to 0.35bar. The decrease of transmission can be due to a denser cake layer caused by the increase of TMP and an increase of the internal fouling as the enzyme aggregates are forced deeper into the membrane., The pores of the membrane become narrower when the internal fouling increases thereby the transmission decreases. This phenomenon should be especially evident when the cross flow velocity is low due to the long residence time of enzyme in the filtration module. And this is exactly the case here. The decrease of transmissions might also be due to the fact that the aggregation rate of LP is more affected by an increase of TMP because the pI of LP is close to pH 5.

The solute fluxes of PLA and LP also decreased with the increase of TMP from 0.26bar to 0.35bar as Figure 5.41 shows.

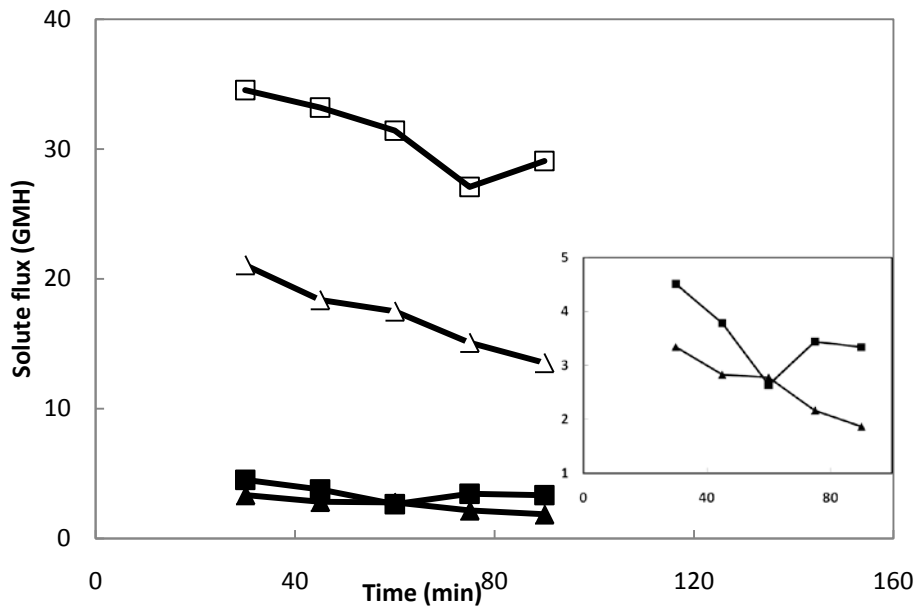

Figure 5.41 Comparison of the solute fluxes of PLA and LP obtained at different TMP during EMF of PLA and LP (■) LP, 0.26bar (□) PLA, 0.26bar (▲) LP, 0.35bar (△) PLA, 0.35bar

The solute flux of PLA was much higher than that of LP due to the higher concentration of PLA in the feed solution. Due to the lower transmissions of both PLA and LP at TMP 0.35bar, the solute fluxes of PLA and LP decreased when the TMP was increased to 0.35bar. Due to the decrease of permeate flux, solute fluxes of both PLA and LP decreased with the time.

The selectivity remained almost the same when TMP changed from 0.25bar to 0.35bar as the following Figure presents. This was due to the fact that the transmissions of PLA and LP changed concomitantly with TMP.

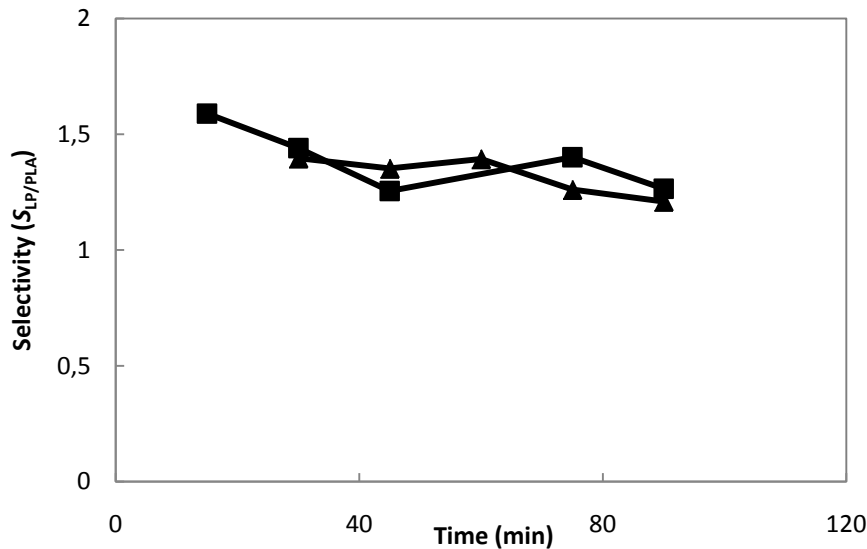

Figure 5.42 Comparison of the selectivity obtained at different TMP during EMF of PLA and LP
 (■) 0.26bar (▲) 0.35bar

5.3.4 Summary

- Separation of PLA and LP was not possible to achieved by MF filtration
- Application of an external electric field across the membrane, separation of PLA and LP can be achieved both by a PS membrane and a cellulose based membrane. Separation performance varied with the membrane used
- When using PS membrane in EMF filtration of PLA and LP, a maximum selectivity($S_{LP/PLA}$) of nearly 5 was achieved; the separation performance was dependent on the feed concentration, with the increase of feed concentration, separation performance decreased slightly; batch variation also influenced the separation performance, slightly better separation performance was achieved when PLA Batch A was sued
- A cellulose based membrane with higher water permeability (also higher porosity than PS membrane) however did not result in better separation performance. Over the investigated conditions, a maximum selectivity ($S_{LP/PLA}$) of around 3 was achieved; the separation performance improved when the solution pH was increased to pH 5.5; electric field strength

in our investigated range have very little effect on separation performance, selectivity was improved slightly by increasing electric field strength; over the investigated range of TMP, transmissions of both PLA and LP decreased concomitantly with TMP thereby the selectivity was not influenced

- The amount of CaCl_2 dosage should be carefully chosen, on one hand enzyme needs Ca^{2+} to be active, on the other hand, Ca^{2+} will cause enzyme precipitate and membrane scaling problem

5.4 Conclusions

Based on the results from MF filtration of single and binary mixture with and without electric field and the investigations of operating parameters on separation performance, the following points can be concluded:

- Transmission and flux of both PLA and LP were dependent on the solution pH. In our studies, it was found that the transmissions of PLA and LP were highest at the solution pH equal to pI only at low operation TMP. The flux is not always lowest at solution pH equal to pI. It also depends on the charge property of membrane
- MF filtration should be operated at low TMP in order to maintain relative constant transmission and flux. Other ions present in the feed can also affect the transmission and flux
- In EMF filtration of single enzyme, the transmissions of both PLA and LP can be manipulated by applying the electric field. However, the flux did not improve which indicated that the depolarization effect was not evident when open membrane such as MF membrane was used.
- Enzyme precipitation caused by low solubility was identified especially at low pH. By increasing the salt concentration in feed solution helped increase PLA solubility. However, addition of salt decreased the zeta-potential of enzyme, thereby weakened the effect of electric field. The amount of salt added into solution should be carefully chosen in order to balance the solubility and the increases of the agglomeration rate which will result in low flux. Using buffer such as NaOAc is an alternative, it can also help keep stable solution pH.
- An increase of transmission was observed when increasing the feed concentration of LP due to a thicker concentration polarization layer.

- With regard to enzymes separation, conventional MF filtration was not possible to achieve separation. By applying the electric field, LP transmission was much enhanced due to additional driving force while PLA transmission either decreased as expected or increased slightly. The increase of PLA transmission was probably due to the friction of LP on PLA resulted from high transport rate thereby speeded up the transport of PLA through the pore. This was more evident with the cellulose membrane which has large porosity. In short, separation of PLA and LP can be achieved in the presence of electric field.
- A maximum selectivity of nearly 5 was obtained with the PS membrane when EMF filtration of 10.2g/L (PLA Batch A+LP) with 21.7% LP and 5mM Na₂SO₄ at pH 5, TMP 0.35bar and electric field strength 1364V/m. With the increase of feed concentration, separation performance decreased slightly.
- When cellulose based membrane was applied in EMF filtration, separation performance was not improved. This was probably due to the fact that the transmissions of both PLA and LP increased concomitantly in the presence of electric field. In the membrane with high porosity, the increase transport rate resulted from the friction of LP on PLA was more evident.
- The separation performance was improved 2-fold factors when the pH was elevated from 5 to 5.5. This was due to the greater increase of LP transmission.
- Over the investigated range of electric field, separation performance was improved slightly with the increase of electric field strength. The separation performance was hardly improved when TMP was elevated over the investigated range.
- Over the investigated range of buffer concentration, separation performance was not affected. However, addition of CaCl₂ resulted in a slightly decrease of separation performance. Therefore, it has to be very careful with the amount of CaCl₂, on one hand there has to be certain amount of CaCl₂ in order to keep enzymes active, on the other hand dosage of CaCl₂ would cause membrane scaling problem and decrease the separation performance.
- Batch variation had effect on the flux, transmission and separation performance. This was due to the difference of diafiltration treatment in the production.

Chapter 6

General discussion and future work

6.1 Conclusions

In this study, the technological feasibility of EMF for enzyme fractionation is studied, validated and compared with the conventional filtration.

As a proof-of-concept, amino acids were used as model solution to test the feasibility of EMF in the application of amphoteric molecules separation. Single amino acid was used to illustrate the effect of electric field on the transport of charged amino acid, the mass transport can be enhanced or decreased enormously when electric field was applied in the same direction with convective transport or opposite with the direction of convective transport. Normal UF filtration is not possible to achieve separation between Glu and Leu because they are transported to permeate at the same rate by convective transport. By applying the electric field in UF filtration, it is possible to uncouple the transport between the charged Glu and neutral Leu. The separation performance can be tuned by choosing different combinations of current density and TMP. The highest selectivity value (separation of Leu from Glu) was achieved at nearly 90 in the conditions of 60A/m² current density and TMP 0.3bar which indicated that EMF can be a potential fractionation technology for enzyme separation. We also learned that the salt concentration in permeate should not be too high to prevent diffusion of salt ions from the feed to permeate. On the other hand, the salt concentration should not be too small to prevent the water splitting caused by the limiting current density situation at the cation exchange membrane between the permeate and electrolyte compartment (especially at polarity +UF- where salt is depleted). Water splitting in permeate would cause pH variation in permeate which eventually affected the amino acid flux. Migration of amino acid back to the feed compartment due to pH change caused by water splitting was observed. In all the cases, 50mM Na₂SO₄ solution was used as initial permeate concentration. The limitation of the set-up however is that positively charged amino acid can pass through cation-exchange membrane thereby migrate to electrolyte compartment.

However enzymes is much more complicated molecules than amino acids for instance membrane fouling is the biggest problem when using membrane filtration process, second the MW of enzyme is much bigger therefore the mobility is not as high as amino acid, third the charge density of enzyme may not be as effective as that of amino acid with regard to electrophoretic force. Thereby, a model protein should be first tried in EMF.

BSA as a well studied protein was used in EMF filtration. EMF filtrations of BSA both using MF and UF membranes were studied and compared with normal MF and UF filtration in terms of flux and transmission. In the studies of EMF filtration using a UF membrane, flux and BSA rejection can be well manipulated and predicted based on the knowledge of solution pH and polarity of electric field especially when solution pH was above 7. When operating with solution pH close to the pI of BSA, the lowest flux was obtained indicating membranes are more easily fouled at pI of the processed solute. It suggests that solution pH determines the electrostatic interaction between the membrane and protein. BSA transmission decreased and flux increased as compared to normal UF when solution pH is controlled to give electrophoretic migration of BSA away from the membrane. Since the MW of BSA is much bigger than the UF membrane cut-off, therefore the BSA transmission was hardly enhanced when solution pH is controlled to give electrophoretic migration of BSA towards membrane. By changing the system set-up from a UF membrane to a more open MF membrane, it has been found that the solution pH influenced the BSA transmission enormously suggesting that the membrane is negatively charged (has also been confirmed by zeta-potential measurement reported in Appendix 8) at the investigated pH range. Likewise, it has been found that BSA transmission decreased and flux increased as compared to normal MF membrane when solution pH is controlled to give electrophoretic migration of BSA away from the MF membrane, this was evident when solution pH was above 7. When the solution is controlled to give electrophoretic migration of BSA towards the membrane, the transmission increased greatly and flux normally decreased slightly as compared to MF filtration. It has been demonstrated that the electric field can used to control the solute transmission by choosing proper polarity and solution pH. However, the transmission and flux were also influenced by the interaction between membrane and solute; therefore one shall take that into account when designing the separation performance. When operating at pH close to pI of the processed solute, the lowest flux was obtained and membranes were more easily fouled. Normally, operation at polarity +UF- it was easier to encounter water splitting reactions caused by the limiting current density situation. It can be concluded that the solution pH, polarity, membrane properties and electric field are the key

parameters when designing a proper EMF filtration process. The surface density of the solute should be high in order to achieve effective separation based on charge.

Based on the results from EMF filtration of BSA, separation experiments with a binary mixture of LP and PLA were performed. Results have shown that separation of LP (side activity) from PLA (main activity) which is not possible to achieve with normal MF has been successfully performed with EMF filtration using MF membrane. The ideal EMF separation process at polarity $-MF^+$ was designed to allow LP transportation to the permeate compartment mainly due to electrotransport and convective transport and to retain the PLA as much as possible by electrotransport. The mass transport can be well explained by the ENP equation as discussed in the Result section. It has been found that in EMF the separation performance in terms of selectivity and LP purity in permeate solution was dependent on the feed concentration, solution pH and membrane property. The effects of increasing electric field strength and TMP on the separation performance were very small in the investigated range. Better separation was observed at lower feed concentration, higher solution pH in the investigated range and with PS MF membrane. Solution pH in this case was both important for enzyme solubility and surface charge, however with higher solution pH in the investigated range LP is more negatively charged and PLA is less positively charged, therefore mass transports of both PLA and LP were enhanced. One shall optimize the solution pH which can both solve solubility issue and balance the mass transport of PLA and LP. Even though the Cellulose based MF membrane has much better water permeability and higher porosity than the PS MF membrane, better separation was achieved with PS MF membrane. This could be due to low porosity of PS membrane which did not favor the transport of PLA. For even better EMF separation, charge property of the porous membrane should be taken into account. For instance, one can take advantage of the charge property to gain higher rejection of one component which has the same sign with the charge of membrane and higher transmission of the other component which has the opposite sign with the charge of membrane. The following Figure 6.1 shows how to design the separation of two enzymes when they have different pIs. It indicates that at the fixed polarity $-MF^+$, enzyme 1 can be removed only when the pI of enzyme 2 is higher than that of enzyme 1. For example, in our case the LP was removed due to the fact that pI of PLA is bigger than that of LP. If the pI of LP was bigger than that of PLA, polarity has to be switched in order to achieve separation.

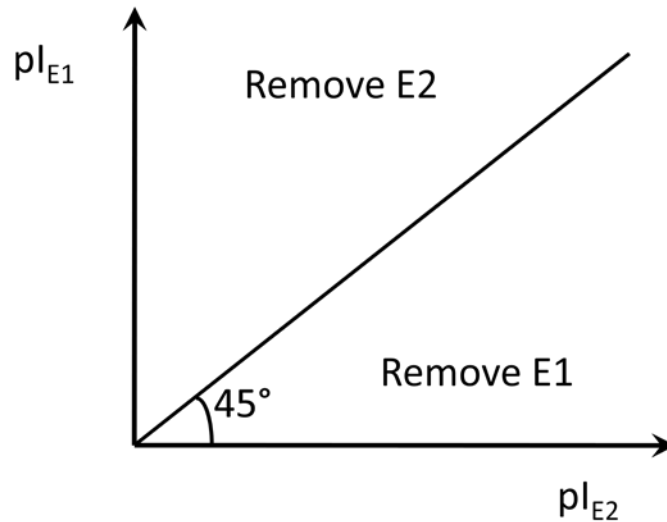

Figure 6.1 Diagrammatic description for the design of binary mixture separation at polarity -MF+

The selectivity obtained from this study was not high enough to achieve complete separation of LP from PLA within a reasonable time because PLA transmission was hardly affected by electric field (the maximum selectivity for separation of LP from PLA was around 5). Besides the fact that separation of enzyme is more complicated than amino acid, the operation mode that used could probably be optimized as follows. Switching the polarity into +MF- and make the main activity PLA removed from feed could be a better operation mode. This is because: 1) MW of PLA is smaller than LP, transmission of PLA in MF is bigger than that of LP; 2) LP is more negatively charged, electrophoretic force is more effective to retain LP; 3) membrane-protein interaction also makes PLA transmission increase and LP transmission decrease.

6.2 Recommendations for future work

In this thesis, we have shown that a binary enzyme mixture can be separated by means of applying electric field through MF filtration at polarity -MF+. However, the selectivity obtained from this study was not high enough to achieve complete separation of LP from PLA within a reasonable time. For the future work, optimization of the system to achieve better separation, economic evaluation of the process and investigation of multicompartiment system will be the key points.

1. EMF separation at polarity +MF- should definitely be tried, where the main activity PLA is to be removed from feed. A higher selectivity can be expected with this operation mode even though it is not logical that the main product is removed from the feedstock.

2. In order to achieve better separation, one shall maximize the mass transport of the solute that is to be removed and minimize the mass transport of the solute that is to be retained. These could be achieved by further optimization of the process conditions: operation times, solution pH, solution conductivity, electric field strength, cross-flow velocity and types and sequence of ion-exchange membranes in the system etc. Furthermore, it appeared that more knowledge about enzyme and membrane characteristics are needed to understand the separation mechanisms involved. A complete membrane characterization would be needed to investigate the effect of hydrophilic/hydrophobic character of the membranes and their charge density on the separation selectivity. As for enzyme, surface charge, electrophoretic mobility and molecular mass are the parameters which should be accounted for. Such investigations could be particularly useful for prediction and optimization of the separation performance.
3. Test more membranes, for example charged membranes and ceramic membranes. The PS membrane has very low water permeability; therefore high productivity cannot be expected. The Cellulose based membrane was claimed as a very hydrophilic membrane; however the membrane was fouled badly during EMF filtration of enzymes. Therefore system control to avoid membrane fouling should be optimized. For instance, TMP can be adjusted to even lower value than 0.35 bar. However, the productivity will be sacrificed. Membranes which have better anti-fouling character and have charge effect favored for separation are desired.
4. NaOAc was used in the feed solution for the purpose of keeping pH constant and CaCl_2 was used for the purpose of keeping enzyme active and soluble. Instead of using NaOAc and CaCl_2 , $\text{Ca}(\text{OAc})_2$ can be tried, which gives both buffer property and provides Ca^{2+} to stabilize the enzymes. The dosage amount should be optimized. Because in our case, there is a trade-off between the solution solubility and surface charge of enzyme. The enzyme precipitated due to the decrease of solubility when the solution conductivity was low. This problem can be solved by dosing NaOAc. However, the dosage of NaOAc would increase the solution conductivity which eventually decreases the surface charge of enzyme thereby jeopardize the electrophoretic effect.
5. Initial permeate solution shall have the same conductivity contributed by buffer as in the feed compartment, which then eliminated the influence on the transport of enzymes due to the same concentration of buffer in feed compartment and permeate compartment. Therefore, instead of using Na_2SO_4 it can be considered using NaOAc or $\text{Ca}(\text{OAc})_2$

6. In the present configuration of the module, a separation of only two solute fractions could be achieved. Therefore, the use of an extra permeate compartment at the other side of the feed compartment, which is also separated from the feed compartment by a porous membrane should be tested. With this configuration (see Figure 6.2), it could be possible to separate a protein mixture in three different protein fractions, provided that the solution pH in the feed compartment can be held within strict limits. For example, if we choose to let the proteins migrate in negatively charged form, anode should be put at feed compartment side. The pH of the feed solution is then adjusted to a pH so that only one protein (say P1) is negatively charged, while the other two proteins (P3 and P2) are positively charged or uncharged. When applying an electric field, the negatively charged protein will migrate to the permeate compartment at anode side, where protein migration stops as the results of higher conductivity and ion-exchange membrane. And the positively charged protein (P3) will migrate to the permeate compartment at the cathode side. The last protein (P2) will ideally stay in the feed compartment. In this process, it is also very important to select the right porous membranes with appropriate pore size, which we can take advantage of the combined effects of charge and sieving. Of course, by putting an extra compartment, an extra pair of inlet and outlet is needed. Since P2 is supposed to stay in the feed compartment, the operation mode should be operated with little or no TMP as like in electrophoretic contactor.

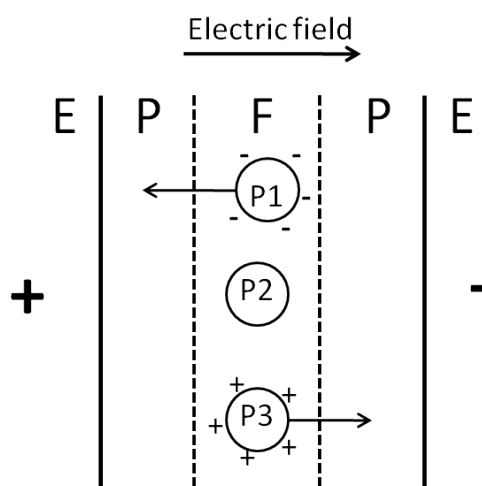

Figure 6.2 Demonstration of multicompartement for trinary mixture protein separation

7. In this work, we only operated EMF in batch mode. Since normally the flow rates in a feed and bleed or fed-batch operation mode are higher than batch mode, higher electric fields

strength can be applied and thus higher protein fluxes may be obtained. Therefore, these operation modes may improve the technological feasibility of EMF and should be tested experimentally. For instance, EMF can be installed directly after the UF concentration which will then be operated a fed-batch mode.

8. Modeling of the separation performance can be considered for future work which can help forecast the effects of some important design parameters such as electric field strength, solution pH and feed concentration etc.
9. Finally, an economic evaluation of this process is expected for future work, for instance the total cost per g separated enzyme as compared to others separation techniques such as chromatography.

Chapter 7

Appendixes

7.1 Appendix 1

Variation of the current, pH and conductivity with time during the EUF of BSA at polarity +UF-, supplemented to section 4.3.1.2.1.1

In the experiments, a DC power supply was used to apply constant potential across the electrodes and the resulting current variations were recorded during the experiments. Variation of the current with time during the EUF of BSA in the 4 experiments is presented in Figure 7.1.

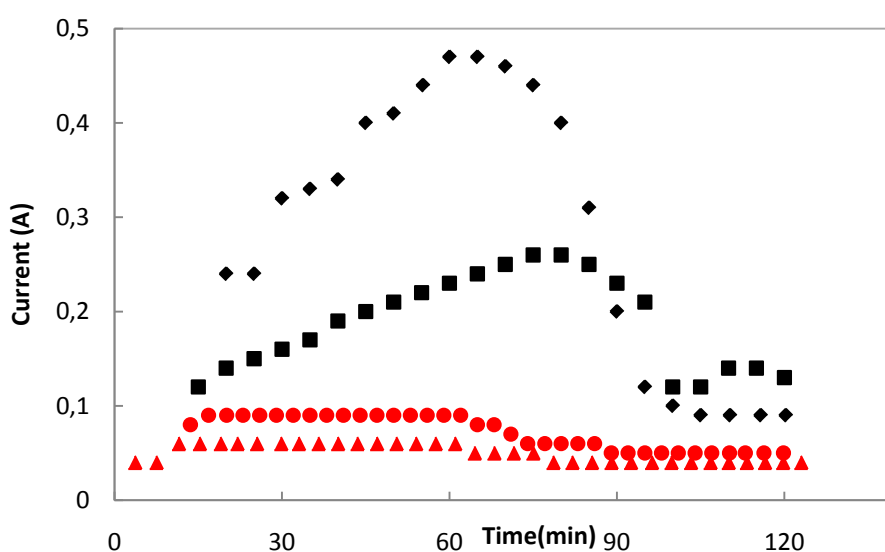

Figure 7.1 Variations of current as function of time in the 4 experiments during EUF of BSA at polarity +UF-, (◆)Nr.8, pH 3.7 ± 0.2 (■)Nr.4, pH 5 ± 0.5 (▲)Nr.1,pH 7.2 ± 0.4 (●)Nr.7,pH 9.7 ± 0.2

Under the influence of the electrical field, electro-transport of BSA from feed compartment to permeate compartment was validated by the variations of pH and solution conductivity both for

permeate and feed solution with time, and the variation of pH and conductivity is presented in Figure 7.2 and Figure 7.3 respectively.

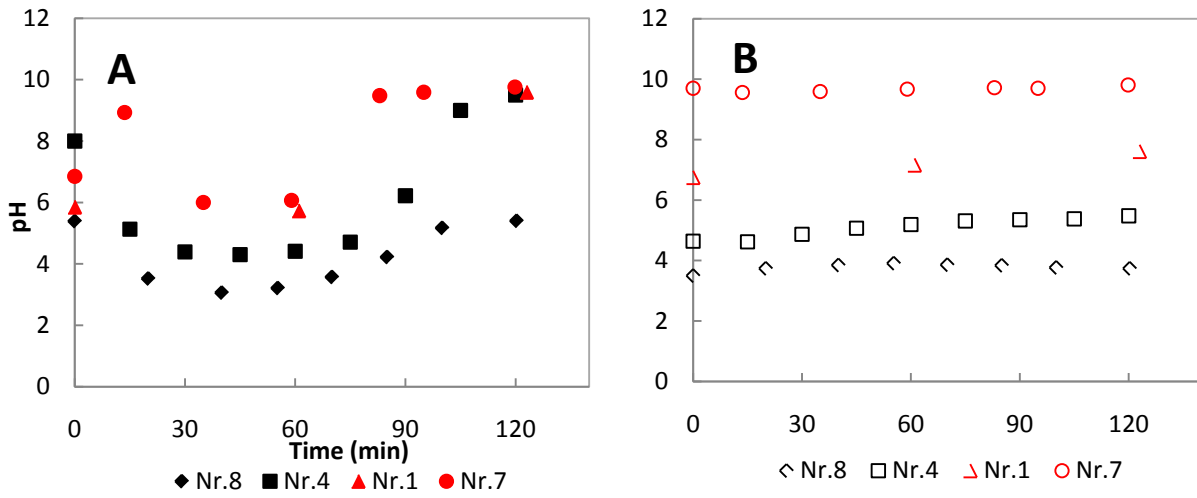

Figure 7.2 Variations of pH in (A) the permeate compartment and (B) the feed compartment during EUF of BSA when operating at polarity +UF-

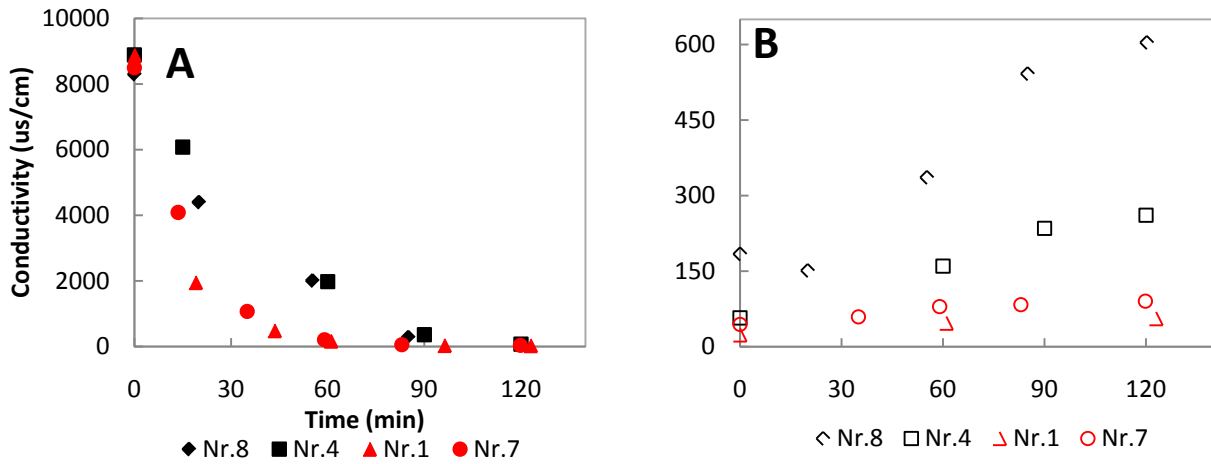

Figure 7.3 Variations of conductivity in (A) the permeate compartment and (B) the feed compartment during EUF of BSA when operating at polarity +UF-

7.2 Appendix 2

Variation of the current, pH and conductivity with time during the electro-transport of BSA at polarity $-UF+$, supplemented to section 4.3.1.2.1.2

Variation of the current with time during the EUF of BSA in the 4 experiments is presented is presented in Figure 7.4.

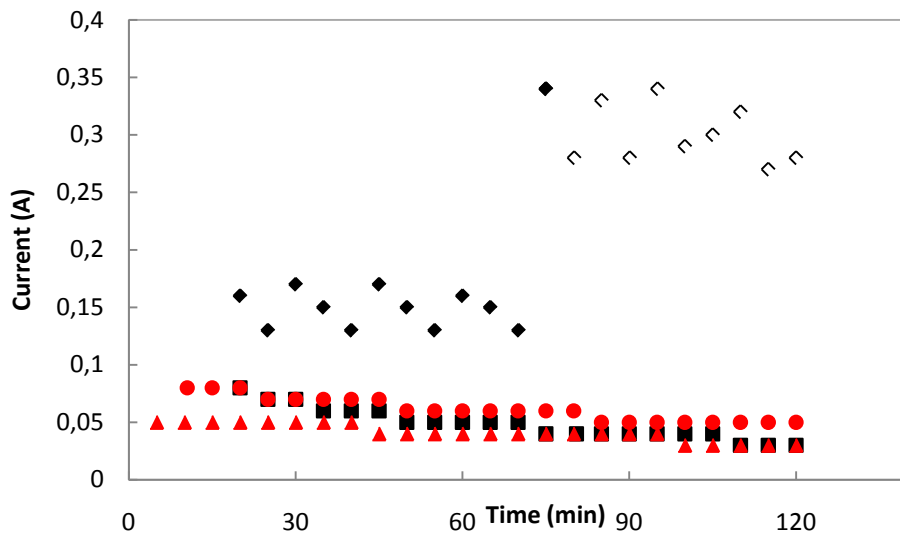

Figure 7.4 Variation of current as function of time during EUF of BSA at polarity $-UF+$, (◆) Nr.6 pH 3.8 ± 0.3 , 909V/m (◇)Nr.6 pH 3.8 ± 0.3 , 1818V/m (■) Nr5 pH 5.4 ± 1 (▲) Nr.2 pH 7.6 ± 0.7 (●) Nr.3 pH 8.9 ± 0.2

The variation of pH and conductivity is recorded during the experiments and presented in Figure 7.5 and Figure 7.6 respectively.

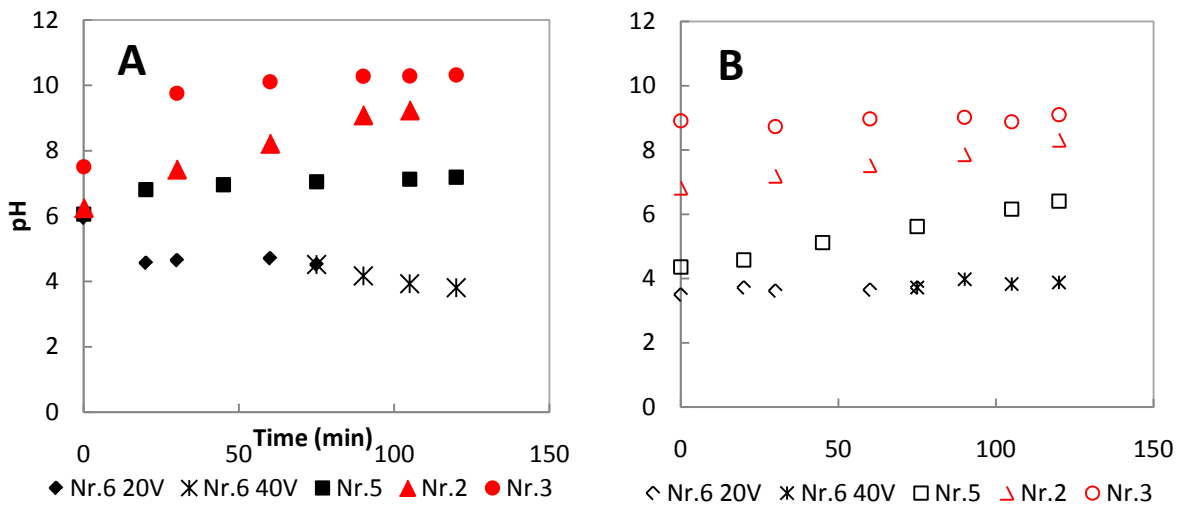

Figure 7.5 Variations of pH in (A) the permeate compartment and (B) the feed compartment during EUF of BSA when operating at polarity -UF+

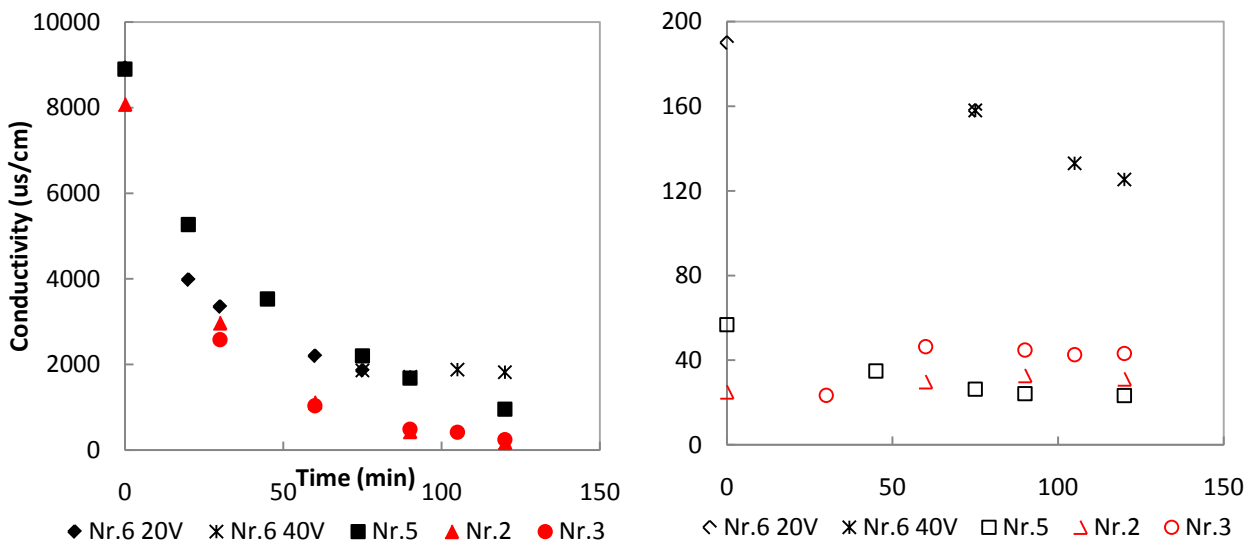

Figure 7.6 Variations of conductivity in (A) the permeate compartment and (B) the feed compartment during EUF of BSA when operating at polarity -UF+

7.3 Appendix 3

Both variation of calculated and measured permeate BSA concentration during each experiments in section 4.3.2.1.2 is plotted in Figure 7.7. The feed solution pH during each experiment was checked and also recorded in Figure 7.7.

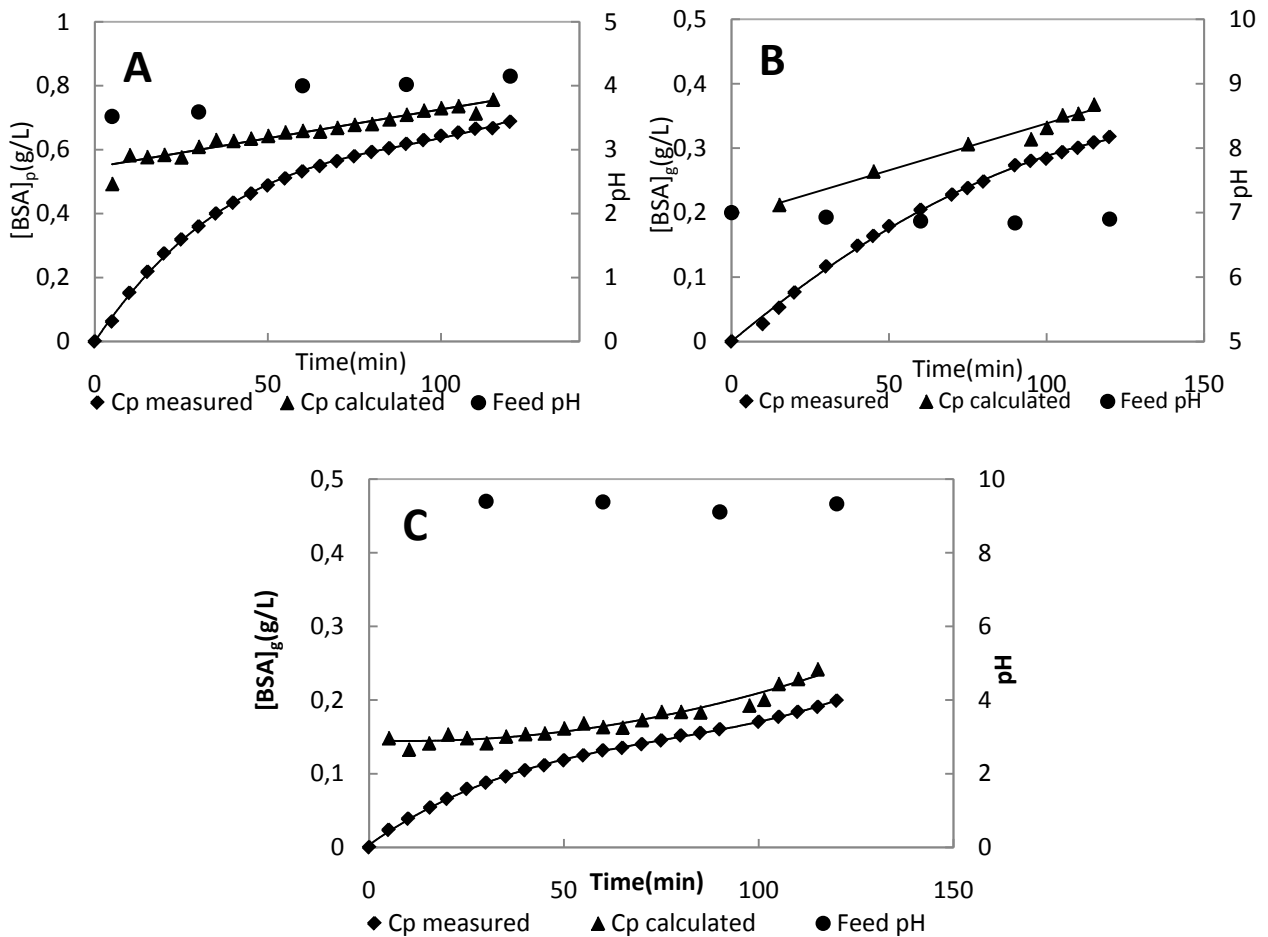

Figure 7.7 Comparison of the measured and calculated permeate BSA concentration during MF of BSA with permeate solution circulating at different feed pH (A) Exp. Nr.5 acidic pH 3.8±0.3 (B) Exp. Nr.10 neutral pH 6.9±0.08 (C) Exp.Nr.7 basic pH 9.5±0.4 (details refer to Table 4.3)

7.4 Appendix 4

The resulting current recorded from Exp. Nr. 4 and Nr.8 in section 4.3.2.2.1.1

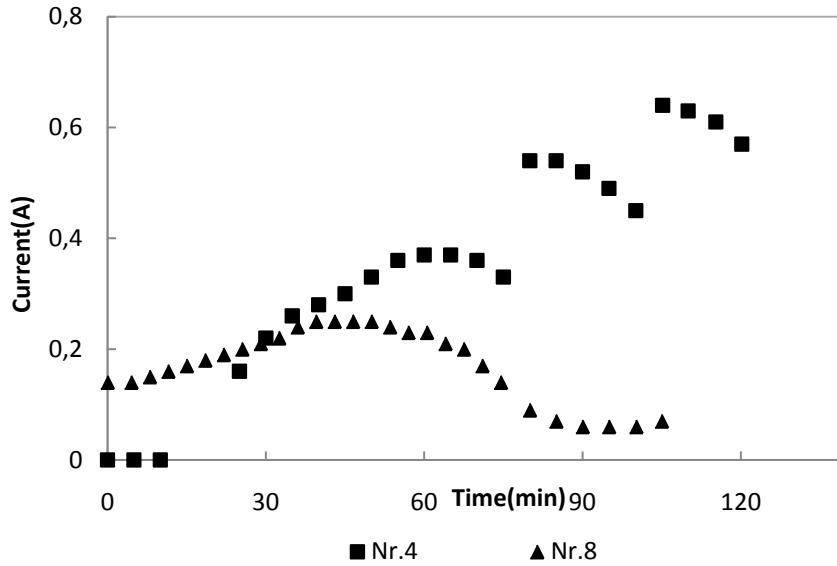

Figure 7.8 The resulting current in Exp. Nr.4 and Nr.8 during EMF of BSA at polarity + MF- at constant electric field 909V/m

The resulting current recorded from Exp. Nr. 3 and Nr.6 in section 4.3.2.2.1.2

The resulting current from these two experiments were recorded in Figure 7.9.

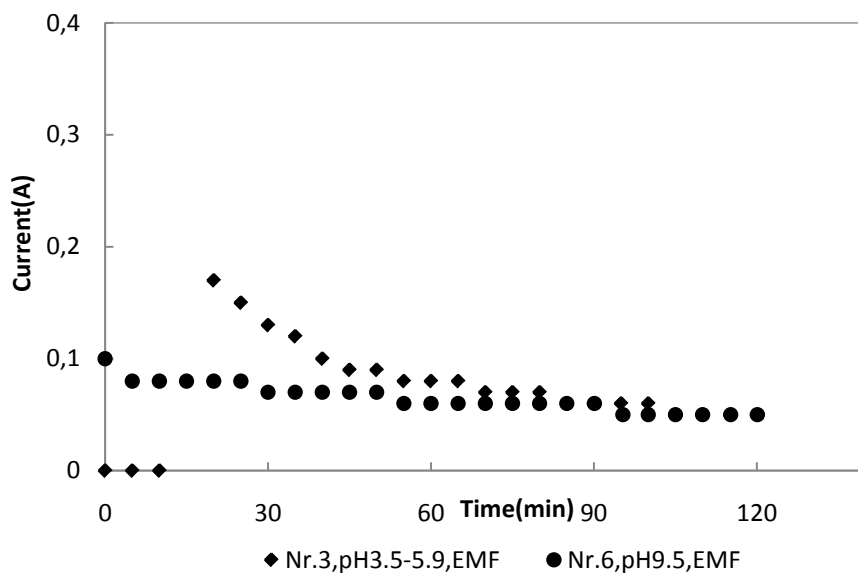

Figure 7.9 The resulting current in Exp. Nr.3 and Nr.6 during EMF of BSA at polarity – MF+ at constant electric field 909V/m

7.5 Appendix 5

Diafiltration of PLA in pilot scale:

Diafiltration of 800Kg PLA Batch B UF concentrate directly from production site in Novozymes, original activity 6100Leu(P)/G with 50.4% sucrose.

Procedure (whole process took 24 hours)

1. 800kg bulk solution diluted into 2000kg solution with water
2. UF filtration (UFX10 pHT from Alfa Laval) at TMP= 4.5bar for about 10.5 hours until the feed volume decreased to 300kg
3. Diafiltration with 1500kg water (5 times as feed volume) overnight until the feed volume decreased to 50kg
4. Titrate the 50kg solution to a certain pH, then put it up into small container and finally froze them

Permeate flow was not controlled; it increased from 130L/h at the beginning to 260L/h at the end of experiment. Temperature in the feed tank was at 20 ± 5 degrees.

During the whole procedure, RI (Refractive index) of both permeate and concentrate, NTU(Nephelometric turbidity unit) and conductivity of concentrated were followed every one hour.

The following Table shows the physical-chemical properties of PLA before and after diafiltration

Table 7.1 Comparison of PLA physical-chemical properties before and after diafiltration

Procedure	pH	NTU	RI in concentrate (%)	RI in permeate (%)	Conductivity in concentrate (ms/cm)	Conductivity in permeate (ms/cm)
Before diafiltration	5.33	9.2	50.8	25	3.54	3.51
After diafiltration	7.57	99.9	10.2	0.1	0.63	0.06

After diafiltration and UF concentration: 53Kg PLA solution with activity 92700Leu (P)/G (=66.2g/L) was obtained.

Yield can be calculated: $92700 \text{ Leu(P)/G} / (6100 * 800/53 = 92075 \text{ Leu(P)/G}) = 100.7\%$

7.6 Appendix 6

Identification of PLA precipitation:

PLA precipitation problem due to the decrease of solubility at low pH and low conductivity was encountered especially using PLA Batch B. The following pictures show how precipitation developed.

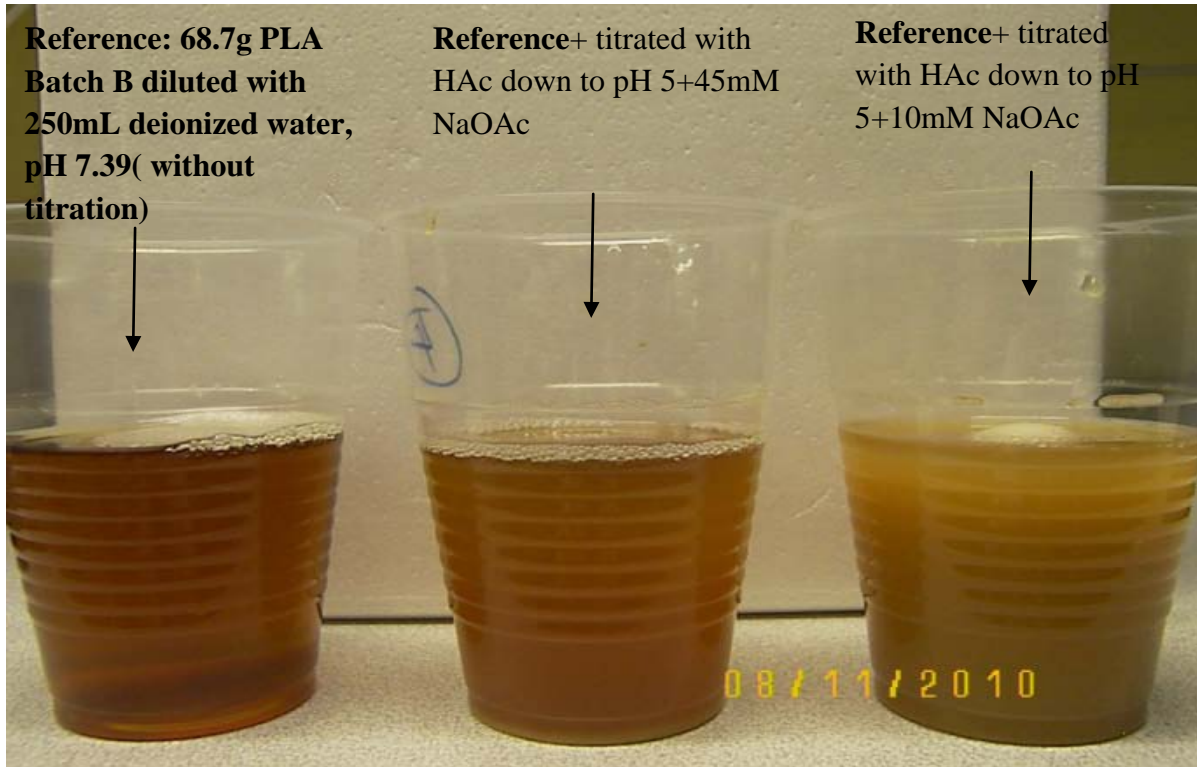

Figure 7.10 Photo showing PLA precipitation happened when pH titrated to 5, the precipitation was mitigated when increasing conductivity

APPENDIX 6

Take same amount of homogenized solution and run centrifugation for 10min at 3900rpm. Precipitation can be easily identified in the following picture.

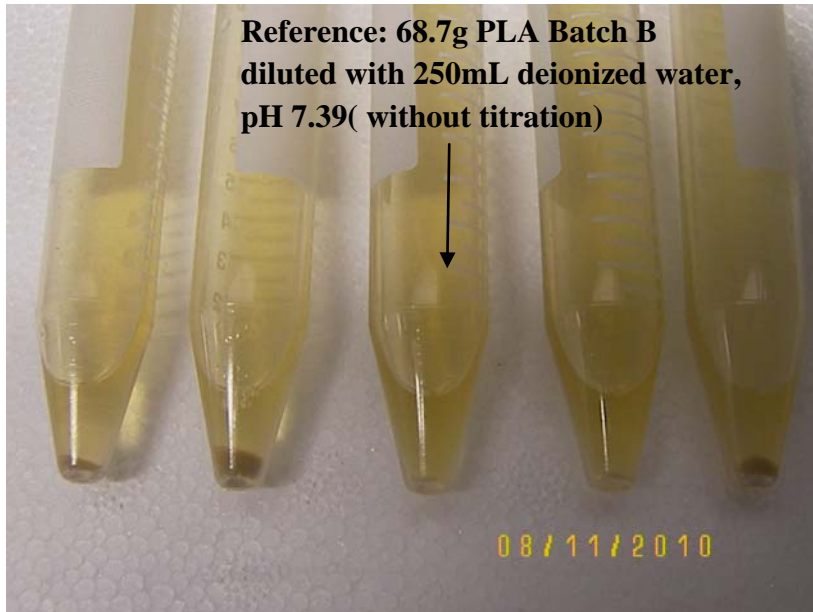

Figure 7.11 Photo showing different PLA solutions after centrifugation, Left to right: Reference+pH5 (titrated with HAc)+45mM NaOAc; Reference+pH5 (titrated with HAc)+10mM NaOAc; **Reference**; Reference+ 25mM NaOAc; Reference+ pH5(titrated with HAc)+25mM NaOAc

7.7 Appendix 7

pI, MW and mobility of PLA and LP:

Isoelectric focusing (IEF) and sodium dodecyl sulfate polyacrylamide gel electrophoresis (SDS-PAGE) were used to determine the pI and MW of PLA and LP respectively.

The pI determination of PLA and LP was run with IEF experiment and the results are shown in Figure 7.12.

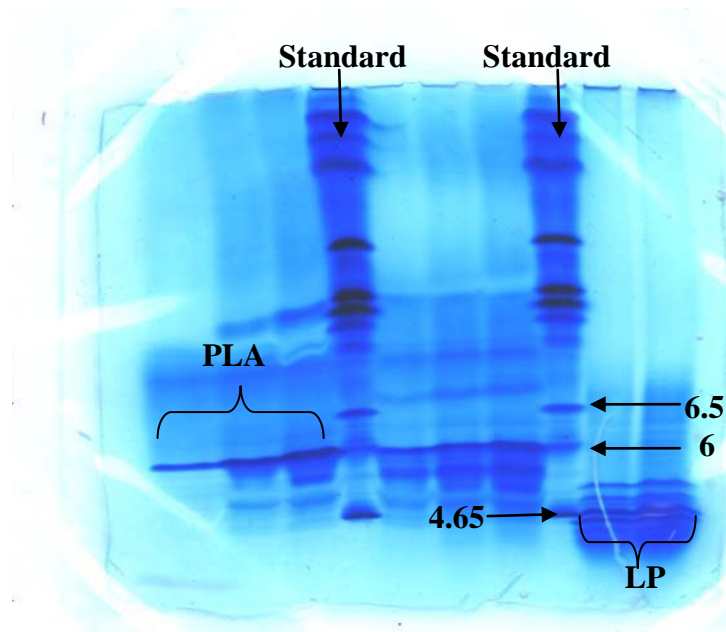

Figure 7.12 IEF results of PLA and LP

MW determination of PLA and LP was performed with SDS-PAGE experiment, the results are presented in Figure 7.13.

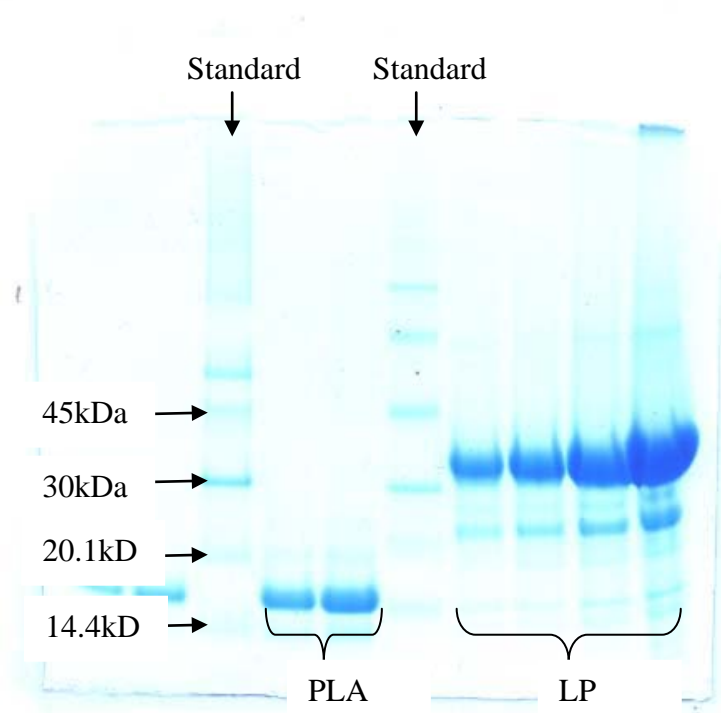
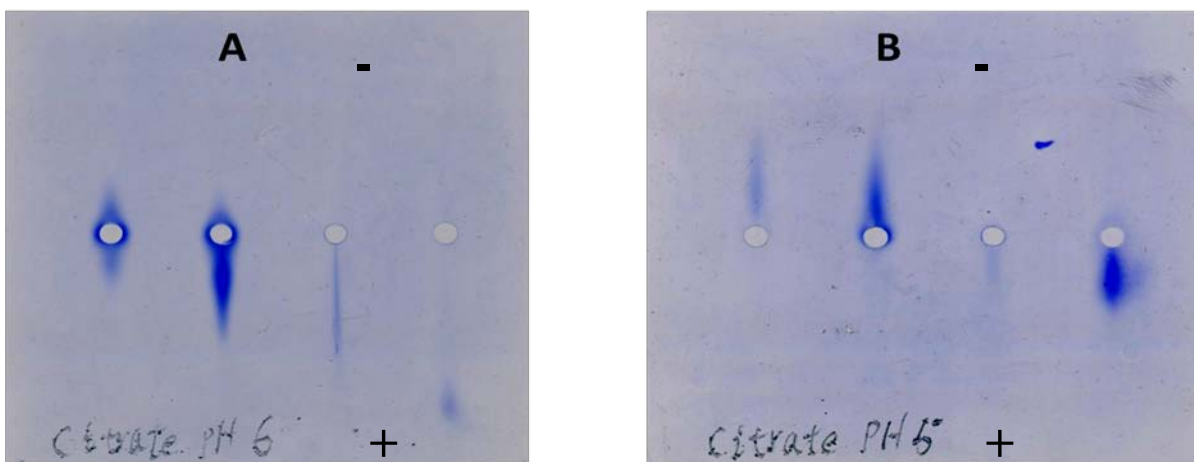

Figure 7.13 SDS results of PLA and LP

Figure 7.14 and D show the results of the gel electrophoresis experiments run at 45V for 60min. Buffer at pH 6: 12.5mM Citric acid and 37mM disodium hydrogen phosphate. Buffer at pH 5: 12.5mM citric acid and 23.25mM disodium hydrogen phosphate



APPENDIX 7

Figure 7.14 Photos showing qualitative analysis of electrophoretic mobility by gel electrophoresis, gels made at (A) pH 6 and (B) pH 5, the circles in the center line were for sample loading. From left to right: PLA Batch A; PLA Batch B; LP; BSA

7.8 Appendix 8

Zeta-potential of membranes:

The zeta-potential of the two MF membranes used in the study (GRM 0.2PP and Hydrosart 0.2 μ m) were performed with Novozymes SurPASS streaming potential/current technology.

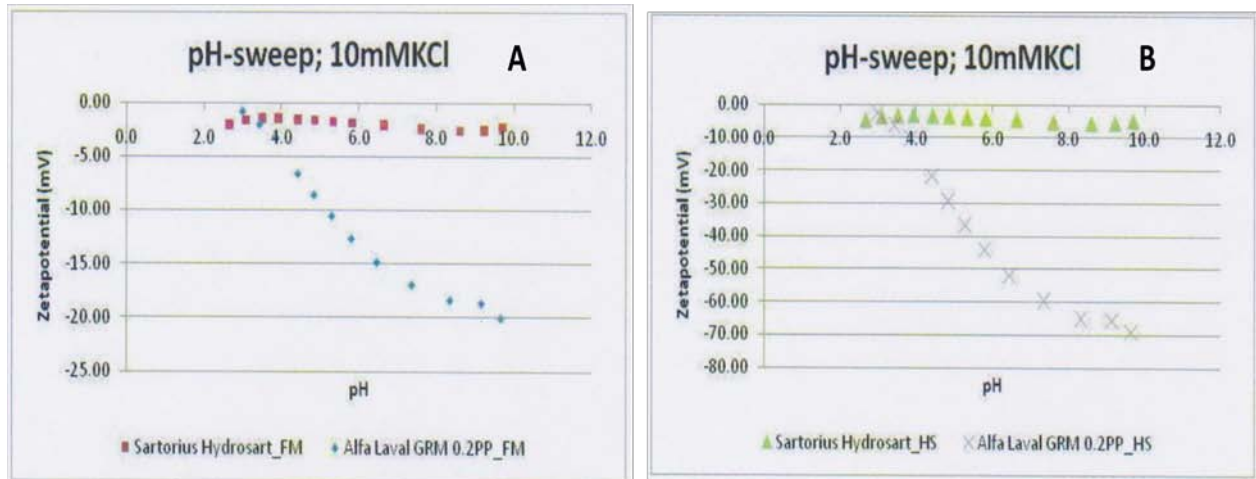

Figure 7.15 Zeta-potential of the MF membranes as function of pH measured in a 10mM KCl solution, zeta-potential calculated based on (A) the Helmholtz-Smoluchowski equation and (B) the Fairbrother-Mastin equation

REFERENCES

- [1] A.D. Enevoldsen, Electrically enhanced ultrafiltration of industrial enzyme solutions, (2007).
- [2] A.D. Enevoldsen, E.B. Hansen, and G. Jonsson. Electro-ultrafiltration of industrial enzyme solutions. *J.Membr.Sci.*, 299 (2007) 28.
- [3] H. Uhlig, *Industrial enzymes and their applications*, John Wiley & Sons, 1998.
- [4] T. Dodge, *Production of Industrial Enzymes*, *Enzymes in Food Technology*, Wiley-Blackwell, 2009, pp. 44-58.
- [5] P. W. Lambert, J. L. Meers and D. J. Best, *The Production of Industrial Enzymes [and Discussion]* *Phil. Trans. R. Soc. Lond. B*, in Anonymous , 1983, pp. 263-282.
- [6] E.A. Falch. *Industrial enzymes — Developments in production and application*. *Biotechnol.Adv.*, 9 (1991) 643.
- [7] R. Spears, *Overview of Downstream Processing*, *Biotechnology Set*, Wiley-VCH Verlag GmbH, 2001, pp. 39-55.
- [8] C. J. Bruton, A. R. Thomson and C. R. Lowe, *Large-Scale Purification of Enzymes [and Discussion]* *Phil. Trans. R. Soc. Lond. B*, 1983, pp. 249-261.
- [9] S.M. Wheelwright. *The design of downstream processes for large-scale protein purification*. *J.Biotechnol.*, 11 (1989) 89.
- [10] D.R. Headon, G. Walsh. *The industrial production of enzymes*. *Biotechnol.Adv.*, 12 (1994) 635.
- [11] C.B. Martin F. Chaplin, *Enzyme technology* , Press Syndicate of the University of Cambridge, 1990.
- [12] A. Wolfgang, *Enzymes in industry:Production and application*, (2007).
- [13] J.C. Janson, L.Ryden. *Protein purification: principles, high-resolution methods, and applications*, Wiley&Sons, 1998.
- [14] A.S. Michaels. *Membrane technology and biotechnology*. *Desalination*, 35 (1980) 329.
- [15] A. Michaels. *Membranes, membrane processes, and their applications: Needs, unsolved problems, and challenges of the 1990's*. *Desalination*, 77 (1990) 5.
- [16] M. Ulbricht. *Advanced functional polymer membranes*. *Polymer*, 47 (2006) 2217.
- [17] R. van Reis, A. Zydney. *Bioprocess membrane technology*. *J.Membr.Sci.*, 297 (2007) 16.
- [18] R.W.Baker., *Membrane technology and applications*, Wiley, 2004.
- [19] M. Nyström, P. Aimar, S. Luque, M. Kulovaara, and S. Metsämuuronen. *Fractionation of model proteins using their physicochemical properties*. *Colloids Surf.Physicochem.Eng.Aspects*, 138 (1998) 185.

REFERENCES

- [20] R. van Reis, A. Zydney. Membrane separations in biotechnology. *Curr.Opin.Biotechnol.*, 12 (2001) 208.
- [21] M.Mulder., *Basic Principles of membrane technology*, Kluwer Academic Publishers, London,UK, 2000.
- [22] W.R. Bowen, P.M. Williams. Quantitative predictive modelling of ultrafiltration processes: Colloidal science approaches. *Adv.Colloid Interface Sci.*, 134-135 (2007) 3.
- [23] C. Martin-Orue, S. Bouhallab, and A. Garem. Nanofiltration of amino acid and peptide solutions: mechanisms of separation. *J.Membr.Sci.*, 142 (1998) 225.
- [24] T. Tsuru, T. Shutou, S. Nakao, and S. Kimura. Peptide and amino acid separation with nanofiltration membranes. *Sep. Sci. Technol.*, 29 (1994) 971.
- [25] A. Garem, G. Daufin, J.L. Maubois, and J. Leonil. Selective separation of amino acids with a charged inorganic nanofiltration membrane: effect of physicochemical parameters on selectivity. *Biotechnol. Bioeng.*, 54 (1997) 291.
- [26] Cheryan M., *Ultrafiltration and Microfiltration Handbook*, , Lancaster, PA: Technomic Publishing Co., 1998.
- [27] G. Russotti, K.E. Goklen. Crossflow membrane filtration of fermentation broth. *Biotechnol. Bioprocess.*, 26 (2001) 85.
- [28] S.T. Kelly, A.L. Zydney. Mechanisms for BSA fouling during microfiltration. *J.Membr.Sci.*, 107 (1995) 115.
- [29] C. Charcosset. Membrane processes in biotechnology: An overview. *Biotechnol.Adv.*, 24 (2006) 482.
- [30] S.M. Bailey, M.M. Meagher. Separation of soluble protein from inclusion bodies in *Escherichia coli* lysate using crossflow microfiltration. *J. Membr. Sci.*, 166 (2000) 137.
- [31] V.S. Espina, M.Y. Jaffrin, and L.H. Ding. Comparison of rotating ceramic membranes and polymeric membranes in fractionation of milk proteins by microfiltration. *Desalination*, 245 (2009) 714.
- [32] K. Hwang, H. Hwang. The purification of protein in cross-flow microfiltration of microbe/protein mixtures. *Separation and Purification Technology*, 51 (2006) 416.
- [33] R. Ghosh. Separation of human albumin and IgG by a membrane-based integrated bioseparation technique involving simultaneous precipitation, microfiltration and membrane adsorption. *J.Membr.Sci.*, 237 (2004) 109.
- [34] C.S. Parnham, R.H. Davis. Protein recovery from bacterial cell debris using crossflow microfiltration with backpulsing. *J.Membr.Sci.*, 118 (1996) 259.
- [35] M.Y. Jaffrin, L. Ding, O. Akoum, and A. Brou. A hydrodynamic comparison between rotating disk and vibratory dynamic filtration systems. *J.Membr.Sci.*, 242 (2004) 155.
- [36] S.S. Lee, A. Burt, G. Russotti, and B. Buckland. Microfiltration of recombinant yeast cells using a rotating disk dynamic filtration system. *Biotechnol. Bioeng.*, 48 (1995) 386.

REFERENCES

- [37] C.S. Parnham III, R.H. Davis. Protein recovery from cell debris using rotary and tangential crossflow microfiltration. *Biotechnol. Bioeng.*, 47 (1995) 155.
- [38] J.H. Vogel, K. Kroner. Controlled shear filtration: a novel technique for animal cell separation. *Biotechnol. Bioeng.*, 63 (1999) 663.
- [39] S. Luque, H. Mallubhotla, G. Gehlert, R. Kuriyel, S. Dzengeleski, S. Pearl, et al. A new coiled hollow-fiber module design for enhanced microfiltration performance in biotechnology. *Biotechnol. Bioeng.*, 65 (1999) 247.
- [40] M. Schutyser, R. Rupp, J. Wideman, and G. Belfort. Dean Vortex Membrane Microfiltration and Diafiltration of rBDNF E. coli Inclusion Bodies. *Biotechnol. Prog.*, 18 (2002) 322.
- [41] J.A. Levesley, M. Hoare. The effect of high frequency backflushing on the microfiltration of yeast homogenate suspensions for the recovery of soluble proteins. *J. Membr. Sci.*, 158 (1999) 29.
- [42] F. Meacle, A. Aunins, R. Thornton, and A. Lee. Optimization of the membrane purification of a polysaccharide-protein conjugate vaccine using backpulsing. *J. Membr. Sci.*, 161 (1999) 171.
- [43] R.T. Kurnik, A.W. Yu, G.S. Blank, A.R. Burton, D. Smith, A.M. Athalye, et al. Buffer exchange using size exclusion chromatography, countercurrent dialysis, and tangential flow filtration: Models, development, and industrial application. *Biotechnol Bioeng.*, 45 (1995) 149.
- [44] R. Ghosh, S.S. Silva, and Z. Cui. Lysozyme separation by hollow-fibre ultrafiltration. *Biochem.Eng.J.*, 6 (2000) 19.
- [45] S. Bhattacharjee, C. Bhattacharjee, and S. Datta. Studies on the fractionation of β -lactoglobulin from casein whey using ultrafiltration and ion-exchange membrane chromatography. *J.Membr.Sci.*, 275 (2006) 141.
- [46] M.C. Yang, J.H. Tong. Loose ultrafiltration of proteins using hydrolyzed polyacrylonitrile hollow fiber. *J.Membr.Sci.*, 132 (1997) 63.
- [47] C.H. Müller, G.P. Agarwal, T. Melin, and T. Wintgens. Study of ultrafiltration of a single and binary protein solution in a thin spiral channel module. *J.Membr.Sci.*, 227 (2003) 51.
- [48] M.C. Almécija, R. Ibáñez, A. Guadix, and E.M. Guadix. Effect of pH on the fractionation of whey proteins with a ceramic ultrafiltration membrane. *J.Membr.Sci.*, 288 (2007) 28.
- [49] R. van Reis, A.L. Zydney, Protein ultrafiltration, in: M.C. Flickinger, S.W. Drew (Eds.), *Encyclopedia of Bioprocess Technology: Fermentation, Biocatalysis, and Bioseparation*, John Wiley & Sons, Inc., 1999, pp. 2197.
- [50] A. Mehta, A.L. Zydney. Permeability and selectivity analysis for ultrafiltration membranes. *J.Membr.Sci.*, 249 (2005) 245.
- [51] N.S. Pujar, A.L. Zydney. Electrostatic effects on protein partitioning in size-exclusion chromatography and membrane ultrafiltration. *J Chromatogr A*, 796 (1998) 229.

REFERENCES

- [52] D.B. Burns, A.L. Zydney. Buffer effects on the zeta potential of ultrafiltration membranes. *J. Membr. Sci.*, 172 (2000) 39.
- [53] B. Cheang, A.L. Zydney. Separation of alpha-lactalbumin and beta-lactoglobulin using membrane ultrafiltration. *Biotechnol Bioeng*, 83 (2003) 201.
- [54] N. Ehsani, M. Nystroem. Fractionation of BSA and myoglobin with modified and unmodified ultrafiltration membranes. *Bioseparation*, 5 (1995) 1.
- [55] M. Nystrom, N. Ehsani, and H. Ojamo. Separation of lignocellulosics hydrolyzing enzymes with modified ultrafiltration membranes. *Bioseparation*, 2 (1991) 187.
- [56] M. Nystrom, P. Aimar, S. Luque, M. Kulovaara, and S. Metsamuuronen. Fractionation of model proteins using their physiochemical properties. *Colloids Surf., A*, 138 (1998) 185.
- [57] S. Nakao, H. Osada, H. Kurata, T. Tsuru, and S. Kimura. Separation of proteins by charged ultrafiltration membranes. *Desalination*, 70 (1988) 191.
- [58] J. Lu, Y. Wan, and Z. Cui. Fractionation of Lysozyme and Chicken Egg Albumin Using Ultrafiltration with 30-kDa Commercial Membranes. *Ind. Eng. Chem. Res.*, 44 (2005) 7610.
- [59] R. Ghosh, Z.F. Cui. Fractionation of BSA and lysozyme using ultrafiltration: effect of pH and membrane pretreatment. *J.Membr.Sci.*, 139 (1998) 17.
- [60] R.H.C.M. van Eijndhoven, S. Saksena, and A.L. Zydney. Protein fractionation using electrostatic interactions in membrane filtration. *Biotechnol. Bioeng.*, 48 (1995) 406.
- [61] S. Saksena, A.L. Zydney. Effect of solution pH and ionic strength on the separation of albumin from immunoglobulins (IgG) by selective filtration. *Biotechnol Bioeng*, 43 (1994) 960.
- [62] T.N. Shah, H.C. Foley, and A.L. Zydney. Development and characterization of nanoporous carbon membranes for protein ultrafiltration. *J.Membr.Sci.*, 295 (2007) 40.
- [63] C.C. Striemer, T.R. Gaborski, J.L. McGrath, and P.M. Fauchet. Charge- and size-based separation of macromolecules using ultrathin silicon membranes. *Nature (London, U. K.)*, 445 (2007) 749.
- [64] S. Cowan, S. Ritchie. Modified polyethersulfone (PES) ultrafiltration membranes for enhanced filtration of whey proteins. *Sep. Sci. Technol.*, 42 (2007) 2405.
- [65] R. Levenstein, D. Hasson, and R. Semiat. Utilization of the Donnan effect for improving electrolyte separation with nanofiltration membranes. *J. Membr. Sci.*, 116 (1996) 77.
- [66] C. Martin-Orue, S. Bouhallab, and A. Garem. Nanofiltration of amino acid and peptide solutions: mechanisms of separation. *J.Membr.Sci.*, 142 (1998) 225.
- [67] A. Garem, G. Daufin, J.L. Maubois, B. Chaufer, and J. Leonil. Ionic interactions in nanofiltration of β -casein peptides. *Biotechnol. Bioeng.*, 57 (1998) 109.

REFERENCES

- [68] Y. Pouliot, M.C. Wijers, S.F. Gauthier, and L. Nadeau. Fractionation of whey protein hydrolysates using charged UF/NF membranes. *J.Membr.Sci.*, 158 (1999) 105.
- [69] Y. Pouliot, S.F. Gauthier, and J. L'Heureux. Effect of peptide distribution on the fractionation of whey protein hydrolysates by nanofiltration membranes. *Lait*, 80 (2000) 113.
- [70] J. Lapointe, S.F. Gauthier, Y. Pouliot, and C. Bouchard. Effect of hydrodynamic conditions on fractionation of β -lactoglobulin tryptic peptides using nanofiltration membranes. *J.Membr.Sci.*, 212 (2003) 55.
- [71] M.C. Wijers, Y. Pouliot, S.F. Gauthier, M. Pouliot, and L. Nadeau. Use of nanofiltration membranes for the desalting of peptide fractions from whey protein enzymic hydrolyzates. *Lait*, 78 (1998) 621.
- [72] D.K. Roper, E.N. Lightfoot. Separation of biomolecules using adsorptive membranes. *J. Chromatogr., A*, 702 (1995) 3.
- [73] E. Klein. Affinity membranes: a 10-year review. *J.Membr.Sci.*, 179 (2000) 1.
- [74] R. Ghosh. Protein separation using membrane chromatography: opportunities and challenges. *Journal of Chromatography A*, 952 (2002) 13.
- [75] H.N. Endres, J.A.C. Johnson, C.A. Ross, J.K. Welp, and M.R. Etzel. Evaluation of an ion-exchange membrane for the purification of plasmid DNA. *Biotechnol. Appl. Biochem.*, 37 (2003) 259.
- [76] M.R. Etzel. Layered stacks [in chromatography]. *J. Chromatogr. Libr.*, 67 (2003) 213.
- [77] X. Zeng, E. Ruckenstein. Membrane Chromatography: Preparation and Applications to Protein Separation. *Biotechnol. Prog.*, 15 (1999) 1003.
- [78] B. Kalbfuss, M. Wolff, L. Geisler, A. Tappe, R. Wickramasinghe, V. Thom, et al. Direct capture of influenza A virus from cell culture supernatant with Sartobind anion-exchange membrane adsorbers. *J. Membr. Sci.*, 299 (2007) 251.
- [79] A. Saxena, B.P. Tripathi, M. Kumar, and V.K. Shahi. Membrane-based techniques for the separation and purification of proteins: An overview. *Adv.Colloid Interface Sci.*, 145 (2009) 1.
- [80] D.S.Hage, Handbook of affinity chromatography , CRC Press, 2005.
- [81] S. Brandt, R.A. Goffe, S.B. Kessler, J.L. O'Connor, and S.E. Zale. Membrane-based affinity technology for commercial scale purifications. *BioTechnology*, 6 (1988) 779.
- [82] E. Ruckenstein, X. Zeng. Macroporous chitin affinity membranes for lysozyme separation. *Biotechnol. Bioeng.*, 56 (1997) 610.
- [83] X. Zeng, E. Ruckenstein. Macroporous chitin affinity membranes for wheat germ agglutinin purification from wheat germ. *J.Membr.Sci.*, 156 (1999) 97.

REFERENCES

- [84] U.B. Finger, J. Thoemmes, D. Kinzelt, and M.-. Kula. Application of thiophilic membranes for the purification of monoclonal antibodies from cell culture media. *J. Chromatogr., B: Biomed. Appl.*, 664 (1995) 69.
- [85] S.M.A. Bueno, K. Haupt, and M.A. Vijayalakshmi. Separation of immunoglobulin G from human serum by pseudobioaffinity chromatography using immobilized L-histidine in hollow fiber membranes. *J. Chromatogr., B: Biomed. Appl.*, 667 (1995) 57.
- [86] F. Cattoli, G.C. Sarti. Separation of MBP fusion proteins through affinity membranes. *Biotechnol. Prog.*, 18 (2002) 94.
- [87] I. Recio, S. Visser. Two ion-exchange chromatographic methods for the isolation of antibacterial peptides from lactoferrin: In situ enzymatic hydrolysis on an ion-exchange membrane. *Journal of Chromatography A*, 831 (1999) 191.
- [88] A. Karger, B. Bettin, H. Granzow, and T.C. Mettenleiter. Simple and rapid purification of alphaherpesviruses by chromatography on a cation exchange membrane. *J. Virol. Methods*, 70 (1998) 219.
- [89] H.R. Charlton, J.M. Relton, and N.K. Slater. Characterization of a generic monoclonal antibody harvesting system for adsorption of DNA by depth filters and various membranes. *Bioseparation*, 8 (1999) 281.
- [90] M.Belanich, B.Cummings, D.Grob, J.Klein, A.O'Connor, and D.Yarosh. Reduction of endotoxin in a protein mixture using strong anionexchange membrane absorption. *Pharm Technol*, (1996) 142.
- [91] E. Iritani, Y. Mukai, and Y. Kiyotomo. Effects of electric field on dynamic behaviors of dead-end inclined and downward ultrafiltration of protein solutions. *J. Membr. Sci.*, 164 (2000) 51.
- [92] S. Oussedik, D. Belhocine, H. Grib, H. Lounici, D.L. Piron, and N. Mameri. Enhanced ultrafiltration of bovine serum albumin with pulsed electric field and fluidized activated alumina. *Desalination*, 127 (2000) 59.
- [93] N. Mameri, S.M. Oussedik, A. Khelifa, D. Belhocine, H. Ghrib, and H. Lounici. Electric fields applied in the ultrafiltration process. *Desalination*, 138 (2001) 291.
- [94] C.W. Robinson, M.H. Siegel, A. Condemine, C. Fee, T.Z. Fahidy, and B.R. Glick. Pulsed-electric-field crossflow ultrafiltration of bovine serum albumin. *J. Membr. Sci.*, 80 (1993) 209.
- [95] T. Weigert, J. Altmann, and S. Ripperger. Crossflow electrofiltration in pilot scale. *J. Membr. Sci.*, 159 (1999) 253.
- [96] P.V. Zumbusch, W. Kulcke, and G. Brunner. Use of alternating electrical fields as anti-fouling strategy in ultrafiltration of biological suspensions - introduction of a new experimental procedure for crossflow filtration. *J. Membr. Sci.*, 142 (1998) 75.
- [97] G.M. Rios, H. Rakotoarisoa, and B. Tarodo de la Fuente. Basic transport mechanisms of ultrafiltration in the presence of an electric field. *J. Membr. Sci.*, 38 (1988) 147.

REFERENCES

- [98] J.M. Radovich, R.E. Sparks. Electrophoretic techniques for controlling concentration polarization in ultrafiltration. *Polym. Sci. Technol.*, 13 (1980) 249.
- [99] Z. Lazarova, W. Serro. Electromembrane separation of mineral suspensions: influence of process parameters. *Sep. Sci. Technol.*, 37 (2002) 515.
- [100] R.J. Wakeman. Electrically Enhanced Microfiltration of Albumin Suspensions. *Food Bioprod.Process.*, 76 (1998) 53.
- [101] Y. Weng, K. Li, L.H. Chaung-Hsieh, and C.P. Huang. Removal of humic substances (HS) from water by electro-microfiltration (EMF). *Water Res.*, 40 (2006) 1783.
- [102] G. Bargeman, M. Dohmen-Speelmans, I. Recio, M. Timmer, and C. Van der Horst. Selective isolation of cationic amino acids and peptides by electro-membrane filtration. *Lait*, 80 (2000) 175.
- [103] G. Bargeman, J. Houwing, I. Recio, G. Koops, and C. Van der Horst. Electro-membrane filtration for the selective isolation of bioactive peptides from an α -casein hydrolysate. *Biotechnol. Bioeng.*, 80 (2002) 599.
- [104] G. Bargeman, G.-. Koops, J. Houwing, I. Breebaart, H.C. van der Horst, and M. Wessling. The development of electro-membrane filtration for the isolation of bioactive peptides: the effect of membrane selection and operating parameters on the transport rate. *Desalination*, 149 (2002) 369.
- [105] J. Lapointe, S.F. Gauthier, Y. Pouliot, and C. Bouchard. Selective separation of cationic peptides from a tryptic hydrolysate of β -lactoglobulin by electrofiltration. *Biotechnol. Bioeng.*, 94 (2006) 223.
- [106] G. Brisson, M. Britten, and Y. Pouliot. Electrically-enhanced crossflow microfiltration for separation of lactoferrin from whey protein mixtures. *J.Membr.Sci.*, 297 (2007) 206.
- [107] S. Lentsch, P. Aimar, and J.L. Orozco. Enhanced separation of albumin-poly(ethylene glycol) by combination of ultrafiltration and electrophoresis. *J.Membr.Sci.*, 80 (1993) 221.
- [108] T. Käppler, C. Posten. Fractionation of proteins with two-sided electro-ultrafiltration. *J.Biotechnol.*, 128 (2007) 895.
- [109] S. Galier, H.R. Balmann. The electrophoretic membrane contactor: A mass-transfer-based methodology applied to the separation of whey proteins. *Separation and Purification Technology*, 77 (2011) 237.
- [110] S. Galier, H. Roux-de Balmann. Study of the mass transfer phenomena involved in an electrophoretic membrane contactor. *J.Membr.Sci.*, 194 (2001) 117.
- [111] S. Galier, H. Roux-de Balmann. Influence of electrostatic interactions in electrophoretic membrane contactors. *Desalination*, 149 (2002) 351.
- [112] S. Galier, H. Roux-de Balmann. Study of biomolecules separation in an electrophoretic membrane contactor. *J.Membr.Sci.*, 241 (2004) 79.
- [113] N. Ndiaye, Y. Pouliot, L. Saucier, L. Beaulieu, and L. Bazinet. Electro-separation of bovine lactoferrin from model and whey solutions. *Separation and Purification Technology*, 74 (2010) 93.

REFERENCES

- [114] J. Mueller, R.H. Davis. Protein fouling of surface-modified polymeric microfiltration membranes. *J.Membr.Sci.*, 116 (1996) 47.
- [115] C.A.P.M. van Nunen, Design of a large scale membrane-electrophoresis module for separation of proteins, (1997).
- [116] J.S. Newman, *Electrochemical Systems*, (1991).
- [117] M.J. Laidler K., *Physical Chemistry*, New York: Houghton Mifflin Company, 1999.
- [118] A.D. Enevoldsen, E.B. Hansen, and G. Jonsson. Electro-ultrafiltration of amylase enzymes: Process design and economy. *Chemical Engineering Science*, 62 (2007) 6716.
- [119] L. Pupunat, G.M. Rios, R. Joulie, M. Persin, and G. Pourcelly. Electronanofiltration: a new process for ion separation. *Sep. Sci. Technol.*, 33 (1998) 67.
- [120] J.M.K. Timmer, M.P.J. Speelmans, and H.C. van der Horst. Separation of amino acids by nanofiltration and ultrafiltration membranes. *Separation and Purification Technology*, 14 (1998) 133.
- [121] J. Lapointe, S.F. Gauthier, Y. Pouliot, and C. Bouchard. Fouling of a nanofiltration membrane by a β -lactoglobulin tryptic hydrolysate: impact on the membrane sieving and electrostatic properties. *J.Membr.Sci.*, 253 (2005) 89.
- [122] A.T. S. Kimura, Separation of amino acids by charged ultrafiltration membranes, in Anonymous , *Membranes and membrane processes*, E. Drioli, M. Nakagaki (Eds.), New York, Plenum press, 1984, pp. 191.
- [123] G. Daufin, F.L. Kerherve, P. Aimar, D. Molle, J. Leonil, and F. Nau. Electrofiltration of solutions of amino acids or peptides. *Lait*, 75 (1995) 105.
- [124] H.S. Lee, J. Hong. Electrokinetic separation of lysine and aspartic acid using polypyrrole-coated stacked membrane system. *J. Membr. Sci.*, 169 (2000) 277.
- [125] T.B. Choe, P. Masse, A. Verdier, and M.J. Clifton. Membrane fouling in the ultrafiltration of polyelectrolyte solutions: poly(acrylic acid) and bovine serum albumin. *J. Membr. Sci.*, 26 (1986) 17.
- [126] http://www.horiba.com/fileadmin/uploads/Scientific/Documents/PSA/AN184_app.pdf .
- [127] K.L. Jones, C.R. O'Melia. Ultrafiltration of protein and humic substances: effect of solution chemistry on fouling and flux decline. *J.Membr.Sci.*, 193 (2001) 163.
- [128] A.D. Marshall, P.A. Munro, and G. Traegaardh. The effect of protein fouling in microfiltration and ultrafiltration on permeate flux, protein retention and selectivity: a literature review. *Desalination*, 91 (1993) 65.
- [129] I.H. Huisman, P. Prádanos, and A. Hernández. The effect of protein–protein and protein–membrane interactions on membrane fouling in ultrafiltration. *J.Membr.Sci.*, 179 (2000) 79.

REFERENCES

- [130] J. Li, R.D. Sanderson, G.Y. Chai, and D.K. Hallbauer. Development of an ultrasonic technique for in situ investigating the properties of deposited protein during crossflow ultrafiltration. *J.Colloid Interface Sci.*, 284 (2005) 228.
- [131] R.J. Wakeman, C.J. Williams. Additional techniques to improve microfiltration. *Separation and Purification Technology*, 26 (2002) 3.
- [132] A. Persson, A. Jönsson, and G. Zacchi. Transmission of BSA during cross-flow microfiltration: influence of pH and salt concentration. *J.Membr.Sci.*, 223 (2003) 11.
- [133] M.K. Mishra, T. Kumaraguru, G. Sheelu, and N.W. Fadnavis. Lipase activity of Lecitase Ultra: characterization and applications in enantioselective reactions. *Tetrahedron: Asymmetry*, 20 (2009) 2854.
- [134] S. Durand, F. Clemente, J. Thouvenot, J. Fauvel-Marmouyet, and L. Douste-Blazy. A lipase with high phospholipase activity in guinea pig pancreatic juice. *Biochimie*, 60 (1979) 1215.
- [135] H.A.a.H. Sober R.A., *Handbook of biochemistry*, 2nd ed., The chemical Rubber Co.,Cleveland,Ohio,Pages C-10 and C-13,1970, .
- [136] C. Visvanathan, R. Ben aim. Studies on colloidal membrane fouling mechanisms in crossflow microfiltration. *J.Membr.Sci.*, 45 (1989) 3.
- [137] P. Blanpain, J. Hermia, and M. Lenoël. Mechanisms governing permeate flux and protein rejection in the microfiltration of beer with a Cyclopore membrane. *J.Membr.Sci.*, 84 (1993) 37.
- [138] A. Bansal, Y.H. Ma, and W.M. Clark. A quantitative investigation of membrane fouling by proteins using energy dispersive spectroscopy. *Key Eng. Mater.*, 61-62 (1991) 505.
- [139] S.P. Palecek, A.L. Zydney. Intermolecular electrostatic interactions and their effect on flux and protein deposition during protein filtration. *Biotechnol. Prog.*, 10 (1994) 207.
- [140] M. Teng, S. Lin, C. Wu, and R. Juang. Factors affecting selective rejection of proteins within a binary mixture during cross-flow ultrafiltration. *J.Membr.Sci.*, 281 (2006) 103.
- [141] S.P. Palecek, A.L. Zydney. Hydraulic permeability of protein deposits formed during microfiltration: effect of solution pH and ionic strength. *J.Membr.Sci.*, 95 (1994) 71.
- [142] W.R. Bowen, J.I. Calvo, and A. Hernández. Steps of membrane blocking in flux decline during protein microfiltration. *J.Membr.Sci.*, 101 (1995) 153.
- [143] C. Ho, A.L. Zydney. A Combined Pore Blockage and Cake Filtration Model for Protein Fouling during Microfiltration. *J.Colloid Interface Sci.*, 232 (2000) 389.
- [144] A.L. Zydney, C. Ho, and W. Yuan, Chapter 2 Fouling phenomena during microfiltration: Effects of pore blockage, cake filtration, and membrane morphology, in Dibakar Bhattacharyya and D. Allan Butterfield (Ed.), *Membrane Science and Technology*, Elsevier, 2003, pp. 27-44.
- [145] P. Heinemann, J.A. Howell, and R.A. Bryan. Microfiltration of protein solutions: effect of fouling on rejection. *Desalination*, 68 (1988) 243.

REFERENCES

- [146] S.T. Kelly, A.L. Zydney. Protein fouling during microfiltration: comparative behavior of different model proteins. *Biotechnol. Bioeng.*, 55 (1997) 91.
- [147] G. Belfort, R.H. Davis, and A.L. Zydney. The behavior of suspensions and macromolecular solutions in crossflow microfiltration. *J.Membr.Sci.*, 96 (1994) 1.
- [148] S. Mochizuki, A.L. Zydney. Sieving Characteristics of Albumin Deposits Formed during Microfiltration. *J.Colloid Interface Sci.*, 158 (1993) 136.
- [149] E.N.D.C. Andrade, C. Dodd. The effect of an electric field on the viscosity of liquids. *Proc. R. Soc. London, Ser. A*, 187 (1946) 296.
- [150] G. Jonsson, C.E. Boesen. Water and solute transport through cellulose acetate reverse osmosis membranes. *Desalination*, 17 (1975) 145.
- [151] A.D. Marshall, P.A. Munro, and G. Trägårdh. Influence of permeate flux on fouling during the microfiltration of β -lactoglobulin solutions under cross-flow conditions. *J.Membr.Sci.*, 130 (1997) 23.