



## Monitering af sandfiltres driftstilstand

Lopato, Laure; Riemer, Morten; Arvin, Erik; Binning, Philip John

*Publication date:*  
2011

*Document Version*  
Også kaldet Forlagets PDF

[Link back to DTU Orbit](#)

*Citation (APA):*

Lopato, L., Riemer, M., Arvin, E., & Binning, P. J. (2011). *Monitering af sandfiltres driftstilstand*. Abstract fra Dansk Vand Konference 2011, Aarhus, Danmark. <http://www.danva.dk/Default.aspx?ID=2717&TokenExist=no>

---

### General rights

Copyright and moral rights for the publications made accessible in the public portal are retained by the authors and/or other copyright owners and it is a condition of accessing publications that users recognise and abide by the legal requirements associated with these rights.

- Users may download and print one copy of any publication from the public portal for the purpose of private study or research.
- You may not further distribute the material or use it for any profit-making activity or commercial gain
- You may freely distribute the URL identifying the publication in the public portal

If you believe that this document breaches copyright please contact us providing details, and we will remove access to the work immediately and investigate your claim.

# Monitering af sandfiltres driftstilstand

Laure Lopato & Morten Riemer, Grontmij A/S.  
Erik Arvin & Philip J. Binning, DTU Miljø

Dansk Vand Konference 2011  
1.-2. november 2011  
Radisson Blu Scandinavian Hotel, Aarhus



Technical University of Denmark  
DTU Environment  
Department of Environmental Engineering



## Sandfilter

2

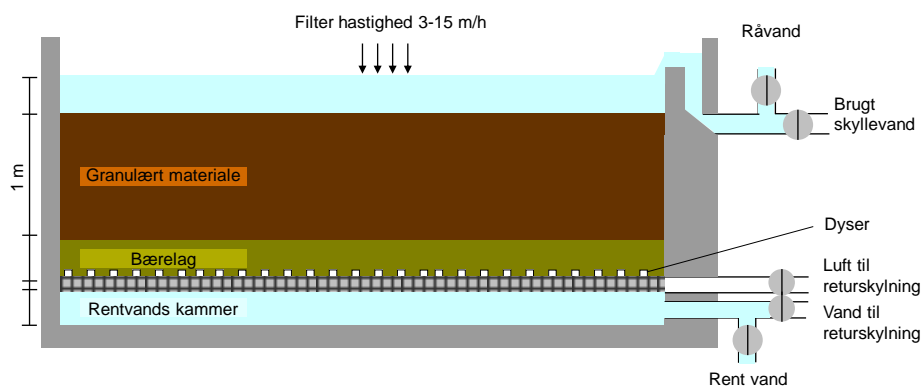

## Hvordan overvåges sandfiltrene i dag?

3

- Kontrol af, om drikkevandsbekendtgørelsen er opfyldt for vandet i udløbet fra filtrene
- Visuel overvågning af tilbageskylprocessen:
  - Er der uens strømningsmønster på overfladen?
  - Bliver skyllevandet rimeligt klart?
  - Er filteroverfladen efter skyl homogen?
- Er tryktabsopbygningen "normal"?
- Nogle få vandværker kontrollerer turbiditet

## Mål med dette indlæg

4

- Hvordan kan man forbedre monitoreringen af sandfiltre for at forbedre drikkevandskvaliteten?
- Hvordan kan man inddrage filtrene i Dokumenteret Drikkevands Sikkerhed, DDS?



## Filter fejlfinding

5



## Filter fejlfinding

6



## Konstaterede problemer

7

- Lav partikel fjernelse, turbiditet
- Lav jern & manganfjernelse
- Lav ammoniumfjernelse
- Tryktabsproblemer
- Vækst/tab af filtermateriale

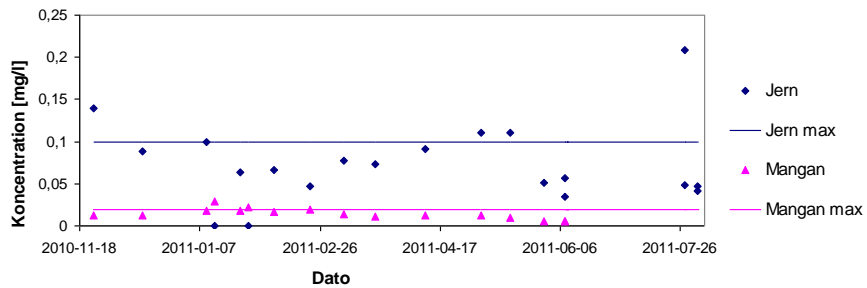

## Filter fejlfinding

8



## Filter fejlfinding

9



## Værktøjskasse

10

1. Sammenfatning af eksisterende data
2. Overflade-observation
3. Returskylnings-observation
4. Ekspansion og returskylningsflow
5. Turbiditet af returskylningsvand
6. Flowmåling
7. Turbiditets-overvågning
8. Tryktabs-overvågning
9. Stokkemetode
10. Hånd penetrometer
11. Udgravning
12. Udtagning af filterkerne (core sampler)
13. Mudderboller analyse
14. Carbonat fældning analyse
15. Partikelbelægnings analyse
16. Partikelstørrelsesfordeling
17. Turbiditets profil
18. Samlet Opløst Gas probe
19. Ammonium profil
20. Salt tracer
21. Ammonium profil og salt tracer
22. Sulfit tracer
23. TDR
24. Georadar

## Indledende undersøgelser

11

- Sammenstilling af eksisterende data:
  - Vandkvalitet, tidsvariation
  - Konstruktionstegninger
- Overflade observation
- Returskylning observation

Tykkelse af det filtrerende lag

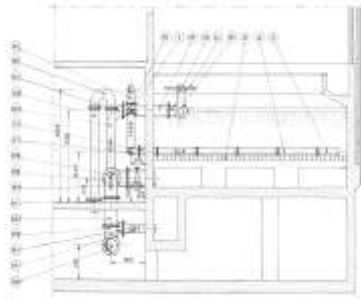
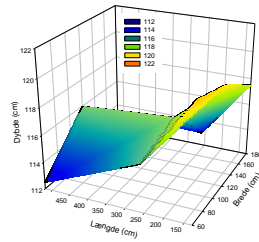

## Returskyl undersøgelse

12

- Filter ekspansion
- Flow under returskylning
- Turbiditet under returskylning



## Driftsundersøgelse

13

- Flow variationer
- Turbiditets-overvågning
- Tryktabs-overvågning

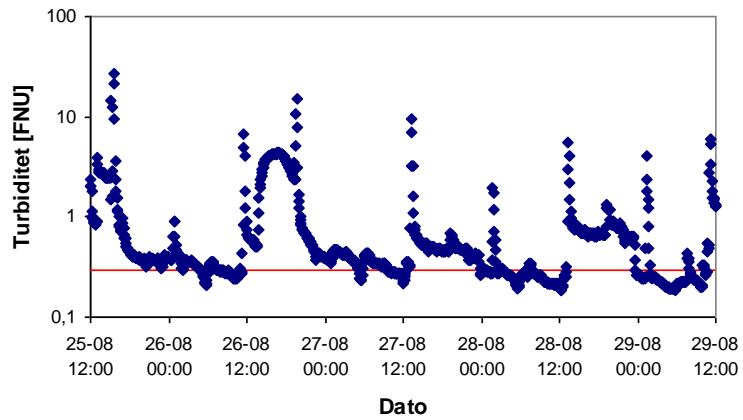

## Filter materiale undersøgelse

14

- Stokkemetode
- Hånd penetrometer
- Udgravning





## Filter materiale undersøgelse

15

- Prøvetager
  - Mudderboller
  - Carbonat fældning
  - Partikel belægninger
  - Partikelstørrelsesfordeling
  - Turbiditets profil
- Samlet Opløst Gas probe



## Filter materiale undersøgelse

16



## Filter materiale undersøgelse

- Salt tracer

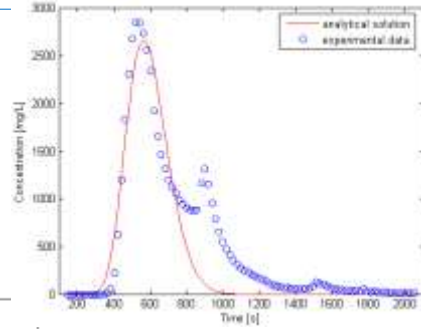

- Ammonium profil

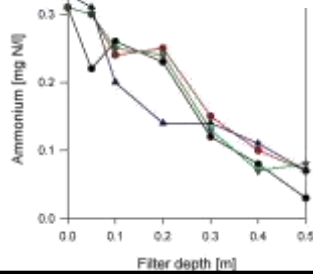

## Filter materiale undersøgelse

18

- Sulfit tracer



- Georadar

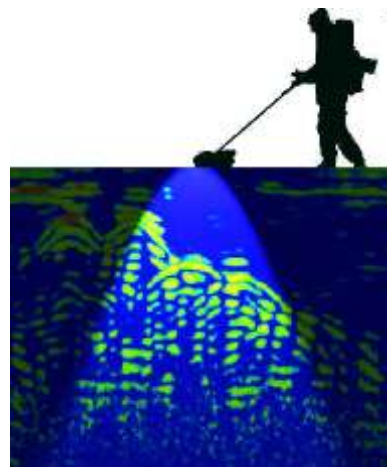

- TDR  
(Time Domain Reflectometry)



## Filter fejlfinding

19

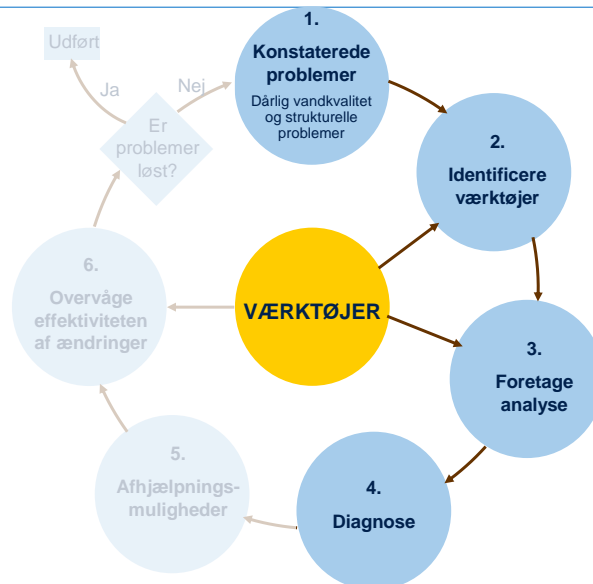

## Diagnose Vandværk 1

20

- Vækst af filtermateriale  
=> Svag returskylning



## Diagnose Vandværk 2

- Vækst af filtermateriale på grund af kalkfældning

=> Uheldig kombination af luft og vandskyl i kombination med hårdt vand

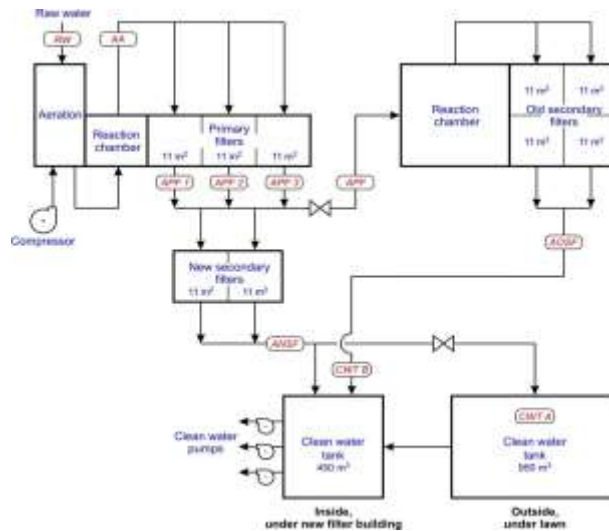

## Diagnose Vandværk 3

22

- Lav jernfjernelse, høj turbiditet
- Tab af granulært medium under returskyl
- Blandet filterlag

=> Dårlig tilstand af filtermaterialet

For stærk beluftning, luftovermætning

=> Indløbsflow forstyrrer filteroverfladen, pludselige flow stigninger



## Driftsundersøgelse

23

- Flow variationer
- Turbiditets-overvågning
- Tryktabs-overvågning

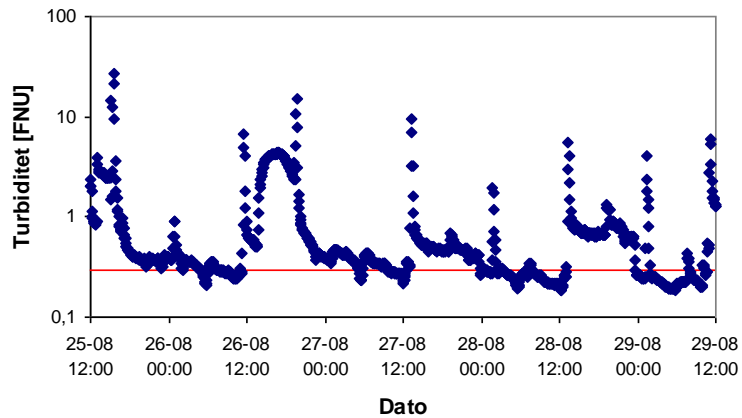

## Diagnose Vandværk 4

24

- Ringe ammoniumfjernelse

=> Svagt returskyl i forfilter



"Fra dårlig til effektiv ammoniumfjernelse i Torplille Vandværk"  
Henrik Blomhøj, Tage Selchau og Erik Arvin.  
Vandposten (151), s. 16-18, 2005.

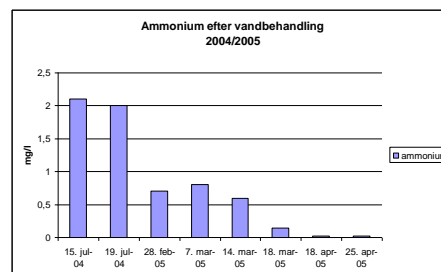
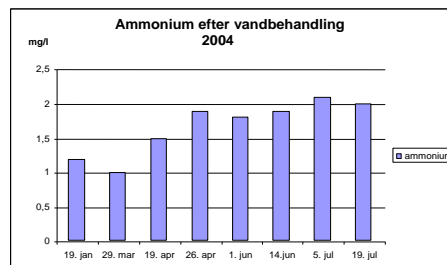

## Filter fejlfinding

25



## Afhjælpningsmuligheder

26

- Forbedre forbehandling
- Forbedre returskylning
- Reducere flow
- Øge vandniveau over filter
- Forbedre flowkontrol
- Nyt indløbsdesign
- Rens/udskift dyser
- Nyt bærelag



## Filter fejlfinding

27



## Dokumenteret Drikkevandssikkerhed - DDS

28

- Brug af diagnostiske værktøjer til DDS

Farlige tilfælde	Styrende kontrolforanstaltninger	Overvågningsgrænser	Overvågning
Turbiditetstoppe forårsaget af pludselige ændringer i indløbs flow	Sikre næsten konstant flow til filter	<5% flow stigning i minuttet	Flowmåler ved indgangen af filteret

## Konklusioner

29

- Sandfiltre drives ikke altid under de bedste betingelser!
- Filter konstruktion og driftsmåde årsag til dårlig filtereffektivitet.



- Næsten ingen dokumentation af driftsproblemer og evt. løsninger.
- Mindst 24 diagnostiske værktøjer til rådighed for "filterdoktoren"
- De diagnostiske værktøjer kan også bruges til filter-DDS.

## Tak for opmærksomhed

30

