



Fuel Pellets from Biomass. Processing, Bonding, Raw Materials

Stelte, Wolfgang

Publication date:
2011

Document Version
Publisher's PDF, also known as Version of record

[Link back to DTU Orbit](#)

Citation (APA):
Stelte, W. (2011). *Fuel Pellets from Biomass. Processing, Bonding, Raw Materials*. Technical University of Denmark. Risø-PhD No. 90(EN)

General rights

Copyright and moral rights for the publications made accessible in the public portal are retained by the authors and/or other copyright owners and it is a condition of accessing publications that users recognise and abide by the legal requirements associated with these rights.

- Users may download and print one copy of any publication from the public portal for the purpose of private study or research.
- You may not further distribute the material or use it for any profit-making activity or commercial gain
- You may freely distribute the URL identifying the publication in the public portal

If you believe that this document breaches copyright please contact us providing details, and we will remove access to the work immediately and investigate your claim.

Fuel Pellets from Biomass

Processing, Bonding, Raw Materials

Risø-PhD-Report

Wolfgang Stelte
Risø-PhD-90 (EN)
December 2011

Risø DTU
National Laboratory for Sustainable Energy

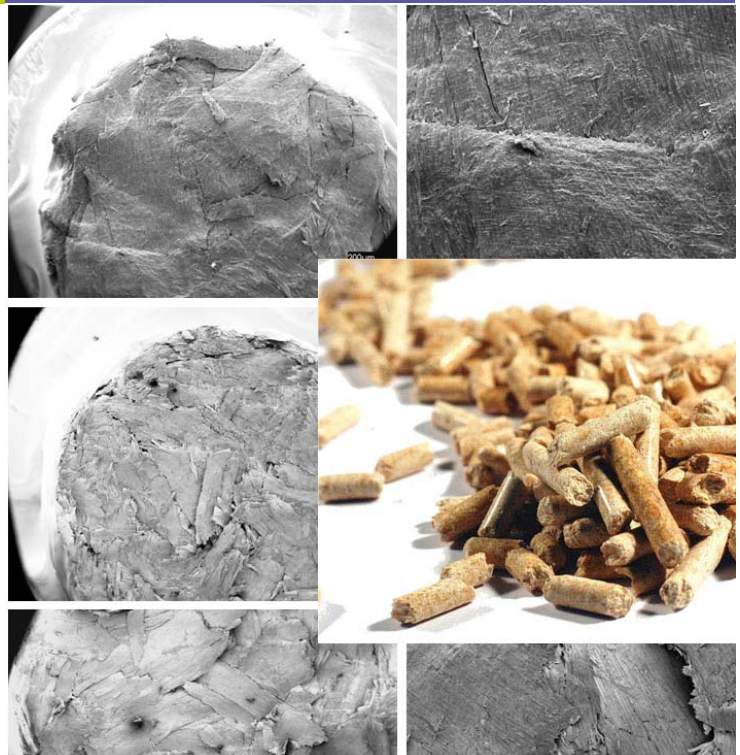

Fuel Pellets from Biomass

Processing, Bonding, Raw Materials

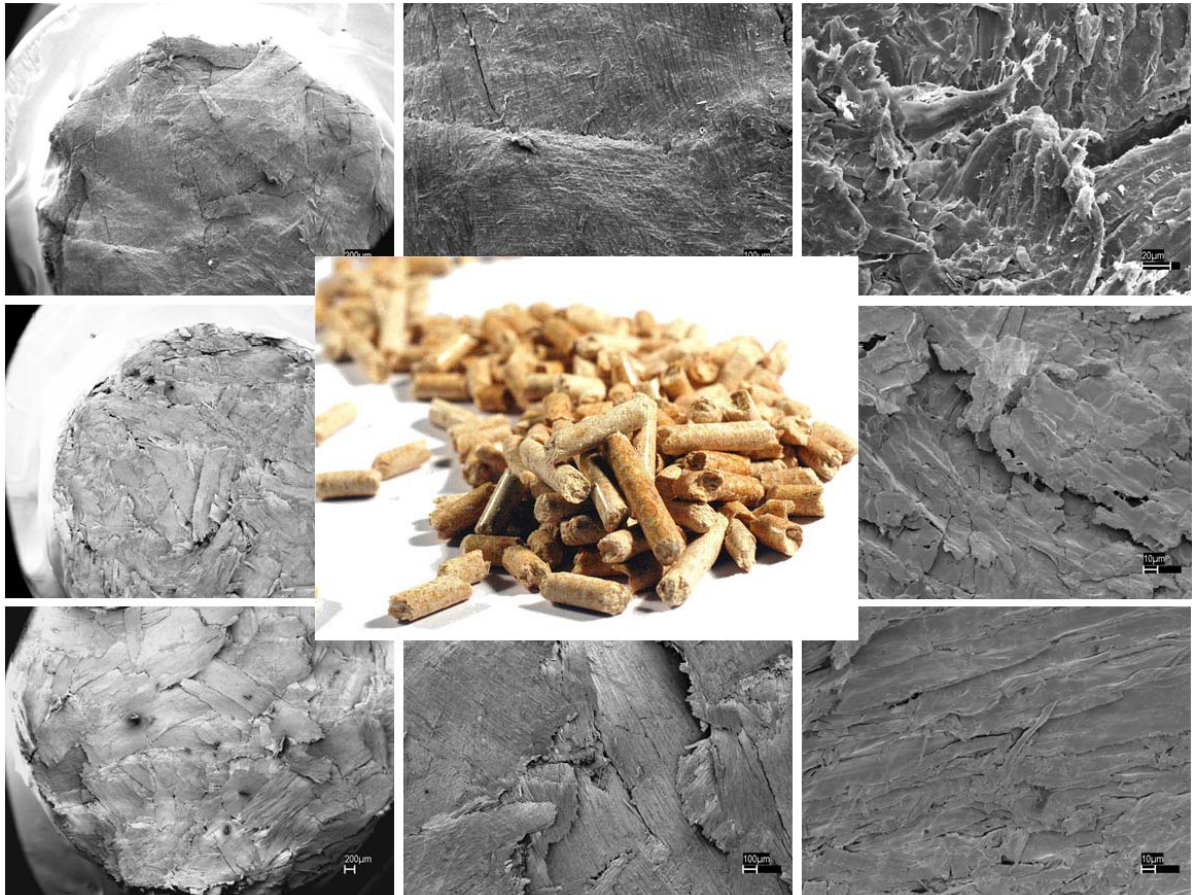

PhD Thesis

Wolfgang Stelte

Risø-DTU

Danish National Laboratory for Sustainable Energy
Technical University of Denmark

Abstract

The depletion of fossil fuels and the need to reduce green house gas emissions has resulted in a strong growth of biomass utilization for heat and power production. Attempts to overcome the poor handling properties of biomass, i.e. its low bulk density and inhomogeneous structure, have resulted in an increasing interest in biomass densification technologies, such as pelletization and briquetting. The global pellet market has developed quickly, and strong growth is to be expected for the coming years. Due to an increasing demand for biomass, the traditionally used wood residues from sawmills and pulp and paper industry are not sufficient to meet future needs. Therefore, new types and sources of biomass will be used more commonly in the future. Although wood pellet production has been an established process for more than 100 years, little research has been conducted about pellet production; it has mainly been about process optimization.

The present study investigates several important aspects of biomass pelletization. Seven individual studies have been conducted and linked together, in order to push forward the research frontier of biomass pelletization processes. The first study was to investigate influence of the different processing parameters on the pressure built up in the press channel of a pellet mill. It showed that the major factor was the press channel length as well as temperature, moisture content, particle size and extractive content. Furthermore, extractive migration to the pellet surface at an elevated temperature played an important role. The second study presented a method of how key processing parameters can be estimated, based on a pellet model and a small number of fast and simple laboratory trials using a single pellet press. The third study investigated the bonding mechanisms within a biomass pellet, which indicate that different mechanisms are involved depending on biomass type and pelletizing conditions. Interpenetration of polymer chains and close intermolecular distance resulting in better secondary bonding were assumed to be the key factors for high mechanical properties of the formed pellets. The outcome of this study resulted in study four and five investigating the role of lignin glass transition for biomass pelletization. It was demonstrated that the softening temperature of lignin was dependent on species and moisture content. In typical processing conditions and at 8% (wt) moisture content, transitions were identified to be at approximately 53-63 °C for wheat straw and about 91 °C for spruce lignin. Furthermore, the effects of wheat straw extractives on the pelletizing properties and pellet stability were investigated.

The sixth and seventh study applied the developed methodology to test the pelletizing properties of thermally pre-treated (torrefied) biomass from spruce and wheat straw. The results indicated that high torrefaction temperatures above 275 °C resulted in severe degradation of biomass polymers, thus reducing the ability to form strong inter-particle bonds and resulting in poor mechanical properties of the manufactured pellets. The results can be used to give an indication for finding the right compromise of high energy density, improved grindability, and sufficient pellet stability.

ISSN 0106-2840
ISBN 978-87-550-3955-1

Information Service Department
Risø National Laboratory for
Sustainable Energy
Technical University of Denmark
P.O.Box 49
DK-4000 Roskilde
Denmark
Telephone +45 46774005
bibl@risoe.dtu.dk
Fax +45 46774013
www.risoe.dtu.dk

Table of content

Table of content	1
Preface and acknowledgements	2
Danish Abstract / Dansk Sammenfatning	4
Publication list	6
Introduction	9
1. Bioenergy and biomass pelletization	12
2. Pelletizing process	15
2.1. Raw materials	16
2.2. Process parameters and modeling	16
2.2.1. Key process parameters	18
2.2.2. Process modeling	22
3. Bond formation in biomass pellets	24
3.1. Role of lignin glass transition	25
4. Recent trends and developments	27
4.1. Torrefaction	27
4.2. Pelletization of torrefied biomass	28
5. Summary of appended papers	29
6. Conclusions	33
7. Application of results	35
8. Outlook	38
References	39
Appendix (Papers I – VII)	47

Preface and acknowledgements

This PhD thesis is submitted as partial fulfillment of the requirements for the degree of the philosophiae doctor (PhD) at Risø – Danish National Laboratory for Sustainable Energy, Technical University of Denmark (Risø-DTU).

The present study was conducted under the framework of the Danish Energy Agency EFP project “Advanced understating of pelletization ENS-33033-0227” during the years 2009-2011. It was based on, and can be seen as a continuation of an earlier project, run during the years 2005-2008 under the frame work of the Danish Energy Agency project “basic understanding of biomass pelletization EFP project No. 33031-037”. The project was finance by the Danish Energy Agency, DONG Energy and Vattenfall to whom I want to express my gratitude.

The study was executed under the supervision of Ulrik Henriksen and Jesper Ahrenfeldt, both from Risø-DTU, Biosystems division, and Jens Kai Holm from DONG Energy. Experimental work took place in the laboratories of the “Biosystems” and “Materials Research” divisions at Risø-DTU in Roskilde, at the department for Bio and Ecosystem Science at Copenhagen University, Frederiksberg and at the USDA Forest Products Laboratory in Madison, Wisconsin, USA.

There are a number of people who have contributed to realize this work. First of all I would like to say thank you to my PhD supervisors Ulrik Henriksen, Jesper Ahrenfeldt and Jens Kai Holm who gave me the opportunity to join their team and to start my research. Thanks a lot for the guidance and advice when needed and the freedom to drive and run my project independently and goal oriented with outstanding cooperation partners from in and outside Denmark. Thank you also to the biomass gasification (BGG) and Bioenergy group (NRG) to welcome me in their team, I have felt home in both groups during the last three years. Special thanks to Freddy Christensen, Kristian Estrup, and Erik Hansen who were always there when technical problems had to be solved. Thanks to Lei Shang who shared an office with me for the good work cooperation and for helping me with Chinese delights over the day. Thanks also to the PhD students and post docs from NRG for their advice and company during the last three years who made my daily life here at Risø a lot more enjoyable.

Thank you also to the numerous cooperation partners outside Risø-DTU. Here especially to Craig Clemons, Charles Frihart, Jane O’Dell, Fred Matt, Thomas Kuster, Daniel Yelle from the USDA Forest Products laboratory in Madison, Wisconsin. Jonas Dahl and Niels Peter Nielsen from the Danish Technological Institute, Dorte Posselt and Thomas Hecksher from Roskilde University, Søren Barsberg and Joana Møller Nielsen from Copenhagen University.

I want to express a very special thanks to Anand Sanadi from Copenhagen University, Faculty of Life Sciences, who taught me how to write papers, and guided me with a lot of advice, knowledge and patience through my whole PhD study.

Last but not least, I would like to thank my dear friends in Copenhagen, Madison and the rest of the world for making the years of my PhD study some of the best in my life. You all made these years very special for me. Finally thank you to my beloved family for all their support and guidance.

Copenhagen, 14th of November 2011

Wolfgang Stelte

Danish Abstract / Dansk Sammenfatning

Titel: Træpiller fra biomasse - Oparbejdning, adhæsion og råvarer

Den fremtidige mangel af fossile brændstoffer og behovet for at reducere udledningen af drivhusgasser har resulteret i en kraftig vækst i anvendelsen af biomasse til kraftvarme-produktion. Som konsekvens af at biomasse som udgangspunkt har dårlige håndteringsegenskaber, dvs. lav densitet og uensartet struktur, har resulteret i en stigende interesse for biomasse-komprimeringsteknologier såsom pelletering og brikettering. Det globale træpille-marked har udviklet sig hurtigt og en yderligere kraftig vækst er forventet indenfor de kommende år når antallet af træpille-forbrugere vokser. På grund af en stigende efterspørgsel på biomasse, er de traditionelt anvendte ressourcer som trærester fra savværker og pulp og papirindustrien ikke tilstrækkelige til at imødekomme det fremtidige behov. Derfor vil nye typer biomasse blive mere almindelige i den fremtidige biopille-produktion. Selvom produktion af træpiller som proces har været kendt i mere end 100 år, er der kun blevet publiceret meget lidt forskning om træpille-produktion og Størstedelen handler om simpel proces-optimering. Den nærværende afhandling undersøger flere vigtige aspekter ved biomasse-pelletering. Syv separate studier er blevet gennemført, for herefter at blive bundet sammen med det formål at højne den generelle forståelse af biomasse-pelleteringsprocesser. Det første studie bestod i at undersøge indflydelsen af forskellige procesparametre på trykket, der bygges op i pressekanalerne i en pillepresse. Resultaterne viste, at den vigtigste faktor var længden af pressekanalen, men også temperatur, fugtighed, partikelstørrelse og indhold af ekstraktiver og deres migration til overfladen ved forhøjet temperatur spiller en vigtig rolle. I det anden studie præsenteres en metode, der viser hvordan nøgleparametre for processen kan estimeres på baggrund af en matematisk model og et mindre antal af hurtige og simple laboratorietests med en enkeltpillepresse. Det tredje studie undersøger bindingsmekanismerne i en biopille. Studiet indiker, at forskellige mekanismer er involveret afhængigt af biomassetypen og pelleteringsforholdene. Dannelse af faste bindinger via lignin mellem tilgrænsende biomassepartikler antages at være den afgørende faktor for de gode mekaniske egenskaber af de dannede piller. Resultatet af denne undersøgelse resulterede i studie fire og fem, hvor betydningen af lignins glasovergang i forhold til pelleteringsegenskaberne af biomassen blev undersøgt. Studierne viser, at glasovergangen af lignin er afhængig af biomassetype og fugtindhold. Under typiske procesbetingelser og med 8 % (wt) vandindhold, blev glasovergangstemperaturen målt til at ligge omkring 53-63 °C for hvedehalm og ca. 91 °C for grantræ. Desuden blev effekten af kemisk ekstraktion af ekstraktiver fra halmoverfladen (cuticula) undersøgt mht. pelleteringsegenskaber og pillestabilitet. Det sjette og syvende studie anvender de metoder og den opbyggede viden fra de foregående studier til at undersøge pelleteringenegenskaberne af termisk forbehandlet (torreficeret) biomasse af grantræ og hvedehalm. Resultaterne viser, at torreficerings temperaturer over 275 °C resulterer i udbredt nedbrydning af biomassen.

Herved svækkes polymerernes evne til at danne stærke bindinger mellem tilgrænsende biomassepartikler, hvilket resulterer i dårligere mekaniske egenskaber af de fremstillede piller. Resultaterne af disse studier kan bruges til at give en indikation af hvordan man finder de rigtige procesparametre, som resulterer i et kompromis mellem høj energitæthed, forbedrede neddelingsegenskaber og høj pillekvalitet.

Publication list

Appended Papers

The PhD thesis is based on work reported in the following articles¹⁻⁷:

- I. Stelte W*, Holm JK, Sanadi AR, Barsberg S, Ahrenfeldt J, Henriksen UB. Fuel pellets from biomass: the importance of the pelletizing pressure and its dependency on the processing conditions. *Fuel*, 2011, 90(11):3285-3290.
- II. Holm JK, Stelte W*, Posselt D, Ahrenfeldt J, Henriksen UB. Optimization of a multi-parameter model for biomass pelletization to investigate temperature dependence and to facilitate fast testing of pelletization behavior. *Energy and Fuels*, 2011,25(8):3706-3711.
- III. Stelte W*, Holm JK, Sanadi AR, Barsberg S, Ahrenfeldt J, Henriksen UB. A study of bonding and failure mechanisms in fuel pellets from different biomass resources. *Biomass and Bioenergy*, 2011, 35(2):910-918.
- IV. Stelte W*, Clemons C, Holm JK, Ahrenfeldt J, Henriksen UB, Sanadi AR. Thermal transition of the amorphous polymers in wheat straw. *Industrial Crops and Products*, 2011, 34(1):1053-1056.
- V. Stelte W*, Clemons C, Holm JK, Sanadi AR, Ahrenfeldt J, Henriksen UB. The effect of lignin glass transition and surface waxes on the pelletizing properties of wheat straw. *Bioenergy Research*, doi:10.1007/s12155-011-9169-8, Article in press.
- VI. Stelte W*, Clemons C, Holm JK, Sanadi AR, Shang, L, Ahrenfeldt J, Henriksen UB, Fuel pellets from torrefied spruce. *Biomass and Bioenergy*, 2011, 35(11):4690-4698.
- VII. Stelte W*, Shang L, Nielsen NPK, Sanadi AR. Pelletizing properties of torrefied wheat straw. Accepted for presentation at World Sustainable Energy Days, European Pellets Conference, Wels, Austria, 2012.

*) corresponding author

Papers written / contributed to during the PhD study, but not part of my thesis:

- VIII.** Stelte W*, Sanadi AR. Preparation and characterization of cellulose nanofibers from two commercial hardwood and softwood pulps. *Industrial & Engineering Chemistry Research*, 2009, 48(24):11211-11219.
- IX.** Shang L*, Ahrenfeldt J, Holm JK, Sanadi AR, Barsberg S, Thomsen T, Stelte W, Henriksen UB. Grindability study of torrefied wheat straw. Submitted.
- X.** Ahrenfeldt J*, Egsgaard H, Stelte W, Thomsen T, Henriksen UB. The Influence of Partial Oxidation Mechanisms on Tar Destruction in Two-Stage Biomass Gasification. Submitted.

*) corresponding author

The PhD research has also contributed to the following conferences and workshops:

Stelte W*, Clemons C, Holm JK, Sanadi AR, Ahrenfeldt J, Shang L, Henriksen UB. Pelletizing properties of torrefied biomass. Oral presentation at: 19th European Biomass Conference and Exhibition. Berlin, Germany, 6-10 June, 2011.

Stelte W*, Clemons C, Holm JK, Sanadi AR, Ahrenfeldt J, Shang L, Henriksen UB. Fuel pellets from torrefied biomass. Poster Presentation at: Biomass Pelletization Workshop. University of British Columbia, Vancouver, Canada, 17-18 May, 2011 and World Sustainable Energy Days – European Pellets Conference, Wels, Austria, 2-4 March, 2011.

Stelte W*, Ahrenfeldt, Henriksen UB. Binding mechanisms in fuel pellets made from biomass. Poster Presentation at: Forest Products Society - FPS 64th International Convention. Madison, Wisconsin, USA, 20-22 June, 2010.

Stelte W*. Advanced understanding of biomass pelletization. Poster Presentation at: World Sustainable Energy Days - European Pellets Conference, Wels, Austria, 3-5 March, 2010.

Stelte W*, Holm, JK, Ahrenfeldt, Henriksen UB. Predictive method for estimating the pelletizing properties of different types of biomass. Oral Presentation at: World Sustainable Energy Days – European Pellets Conference Wels, Austria, 3-5 March, 2010.

Stelte W*, Holm JK. Mechanical forces in wood pellet production. Poster Presentation at: World Sustainable Energy Days. Wels, Austria, 25-26 February, 2009.

*) presenting and/or corresponding author

Introduction

The compaction of biomass into pellets and briquettes is an old process which has been known for more than 100 years⁸. There are many different applications for densified biomass products, ranging from pharmaceutical tablets, animal feedstock and bedding material to energy carriers. The utilization of biomass pellets and briquettes for heat and power production had its roots in the oil crisis during the early and late 1970s. Political upheavals in the Middle East caused an increasing oil price and delivery bottlenecks, which resulted in actions to find alternative energy resources based on local resources. The interest in fuel pellets decreased in the years after the oil crisis, which is also reflected by the low number of scientific publications about pellets and briquettes between the late 1980s and the beginning of the 21st century⁹.

The depletion of fossil fuels on the one hand and an increasing demand on the other has resulted in a steadily increasing price of oil and gas¹⁰. Furthermore, the combustion of fossil fuels has been identified as the major contributor to climate change and global warming^{11,12}. The insight that alternative energy sources are needed to decrease our dependency on fossil fuels and to reduce green house gas (GHG) emissions has resulted in an increasing interest in biomass for bioenergy and an increasing interest in pelletization and briquetting technologies.

Fuel pellets today are (with a few exceptions) made from wood residues; however, an increasing demand has resulted in a lot of efforts to extend the raw material base to agricultural residues, i.e. grasses, husks, pulps and energy grasses¹³. The raw material base for briquettes has always been more diverse, since briquetting compared to pelletizing processes is a lot more flexible when adjusting to new types of raw materials. Nevertheless, pellets have some important advantages when compared to briquettes. Due to their small size, pellets can be transported by vacuum pumps, almost like liquid fuels. Their defined and standardized physical dimensions allow automated feeding and combustion in boiler systems, which greatly ease the biomass handling properties¹³.

Political decision-makers have set clear goals for power producers to reduce their GHG emissions and several power producers in Europe have started to use biomass pellets as fuel for their power plants as a fast and efficient way to switch from fossil to renewable energy carriers^{14,15}. Huge investments have been made into wind and solar power; however, since they are subject to climatic and seasonal fluctuation, their energy output is erratic and difficult to predict. Biomass can provide a steady base load and can easily be adjusted to the actual need^{16,17}. Since most heat and power plants today are coal-fired, different pre-treatment technologies have been tested to produce a “coal-like” fuel based on biomass, which can be utilized in existing power plants. Here, a thermal biomass pre-treatment process, known under the term “torrefaction”, has raised the interest of the power industry. In combination with pelletization, it results in “coal-like” pellets that can be used for co-firing with coal in existing coal power plants¹⁸.

The increasing use of pellets and the extension of the raw material base are resulting in the need for a deeper understanding of the pelletizing process; this has been the motivation for the present research project.

The present study can be subdivided into four different topics to find answers to the most urgent questions concerning fuel pellet production from biomass:

1. How can new raw materials be tested for their pelletizing properties? Today's process development is mainly based on time- and cost-intensive pilot scale tests and personal experience. The aim was to develop a set of fast and simple laboratory test methods.
2. Which process and raw material parameters have the greatest influence on pelletizing processes and how can they be optimized? The aim was to make a study to test the impact of various parameters on the pelletizing process and pellet quality, to identify the process key parameters and to further develop a mathematical model that predicts the pelletizing behavior.
3. What makes a biomass pellet stick together and how can the bonding be improved? Good inter-particle bonding is the requirement for high pellet quality. An understanding of the bonding mechanisms is important for process optimization
4. How does thermal pre-treatment of biomass (torrefaction) influence the pelletizing properties? Torrefaction increases the biomass energy density, improves the combustion properties, and improves storability. Therefore torrefied pellets are regarded as an ideal raw material for pelletizing processes. The aim was to study the chemical changes of the biomass during torrefaction and to understand how these influence the pelletizing properties and pellet quality.

The different questions have been addressed in the seven research articles written during this study.

Paper I and II^{1, 2} are addressing the need to develop a laboratory scale test method to evaluate the impact of raw material and processing parameters on the pelletizing process using a single pellet press. They are also addressing how such data, in combination with modeling, can be used to estimate the pelletizing properties in a full scale pellet mill. **Paper III**³ investigates the bonding mechanism in pellets made from different biomass resources. **Paper IV**⁴ studies the thermal transitions of wheat straw and spruce amorphous polymers. **Paper V**⁵ studies the influence of these transitions on the pelletizing properties and pellet stability. **Paper VI and VII**^{6,7} apply the gained knowledge and developed methods to specific, more practical cases - the two cases regarding the pelletization of torrefied spruce (**Paper VI**⁶) and torrefied wheat straw (**Paper VII**⁷). Those research articles form the core of this thesis and contain detailed

background information, a literature review, materials and methods description, a detailed discussion with previously published studies, and conclusions.

Chapters 1-4 review different aspects of biomass pelletization. Chapter 1 sets the process into a broader context of biomass and bioenergy production. Chapter 2 reviews the literature with respect to origin of the process, raw materials, process parameters and modeling. Chapter 3 reviews bond formation in densified biomass in general and more specific for pellets. Chapter 4 looks on recent trends and developments. The papers written during this study¹⁻⁷ are included in the review section that will form the base of a future review article. Chapter 5 summarizes the written papers and chapter 6 and 7 draw conclusions and discuss the application of the results. Chapter 8 provides an outlook on future challenges.

1. Bioenergy and biomass pelletization

Today's heat and power production depends to large extends on fossil resources, such as coal, oil and gas. They account for more than 81% of the world's total primary energy supply¹⁰. Global climate change scenarios, depleting fossil fuels and an unfavorable dependency on politically instable regions, rich in oil and gas, have triggered the development of renewable energy sources. The utilization of biomass for energy is just one out of many options but has some key advantages that make it attractive. In contrast to wind and solar power, biomass utilization can provide a base load, a continuous and steady flow of energy which is not influenced or even interrupted by night hours, seasonal or climate effects. It can furthermore provide high grade heat and can be converted into liquid and gaseous fuels that allow the integration into existing infrastructures i.e. transportation¹⁹. Biomass combustion is regarded as CO₂ neutral, since it permanently reproduces itself. Nevertheless this statement is only valid under the assumption of sustainability which is sometimes difficult to define and subject of discussions^{16,20,21}.

The share of bioenergy in the world's primary energy consumption is relatively low. About 13% of the world's energy supply is based on renewable resources and bioenergy is with a share of 77% by far the biggest contributor, mainly due to the traditional combustion of woody biomass¹⁰.

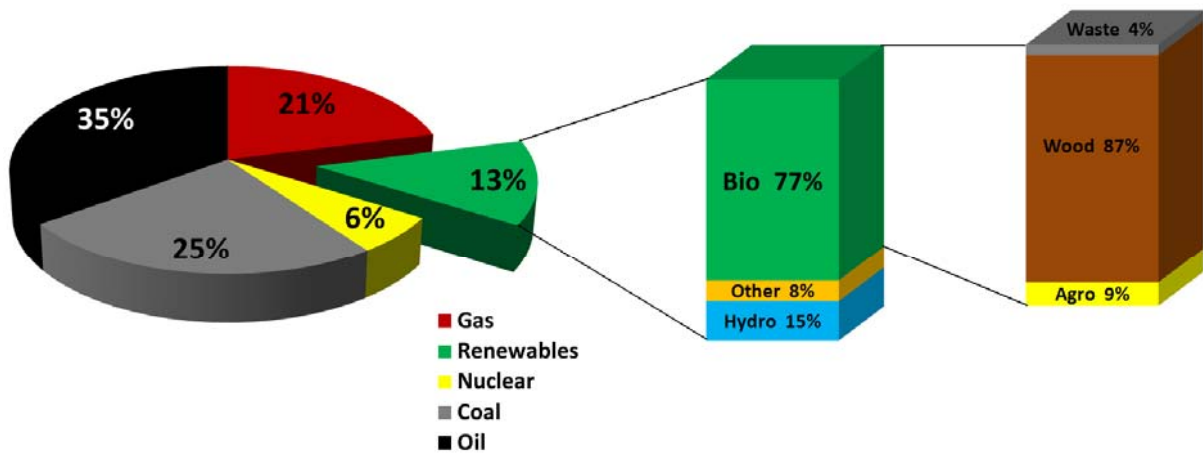

Figure 1. Share of bioenergy on global energy supply^{10,16}.

One of the major factors limiting the utilization of biomass for heat and power production is its low bulk density, resulting in poor and cost intensive handling properties. The distances between biomass production sites, such as forest and agricultural land and industrial and residential areas where the energy is needed are often great and require expensive transportation and storage facilities.

The bulk density of biomass is about 40-150 kg/m³ for grasses^{22,23} and about 150-200 kg/m³ for commercial woodchips²⁴. Pelletization of biomass increases the biomass bulk density to about 700 kg/m³²⁵. Apart from density increase, pelletization offers several other benefits, such as a homogeneous shape and structure that is advantageous for automated feeding into boiler systems¹³. Standardized composition and product quality eases the global trade and utilization of biomass pellets. Standard pellet size and shape allow easy storage and transportation in trucks, ships and storage facilities, and they can be moved from one place to another simply by pumping. Pelletization can reduce dust formation during biomass handling, and pellets have a large surface to volume ratio and contain only small amounts of water (usually less than 15 %) which makes them relatively resistant to decay processes as long as they are stored dry.

The world's largest regions of biomass pellet production and consumption are Europe and North America. The pellet market is booming and the main driving forces are national and international agreements to reduce the green house gas (GHG) emissions, such as the European "2020 goal" and the US American "Energy Independence and Security Act (EISA)" that are triggering the utilization of biomass for heat and power production^{14,26,27}.

The market price for pellets has been shown to be rather volatile and closely connected to the oil price, economic situation and energy demand²⁶. Sikkema et al.²⁶ and Spelter and Toth²⁸ have made market studies for both Europe²⁶ and Northern America²⁸. The wood pellet production within the European Union (EU-27) was about 10 million tons during 2009, while the pellet consumption was about 9.2 million tons at the same time, representing about 0.2 % of the Gross Energy consumption in Europe²⁶. The price per ton fluctuates with the economic conditions and was at about 125 EUR/ton at the end of the year 2010²⁶. Pellet markets within the EU are very different in their characteristics. Markets in Belgium, The Netherlands, The United Kingdom and Poland are dominated by large scale bulk markets for power plants. The Scandinavian markets (Denmark, Norway and Sweden) consist both of a bulk market for district heating and large scale combined heat and power (CHP) plants but also a considerable amount of pellets are used in small scale residential and industrial boilers for heating. In Germany and Austria pellets are predominantly used in small scale residential and industrial boilers for heating and are usually provided in bulk form. Small scale consumers using bagged wood pellets in residential stoves are the major consumers in Italy, Bulgaria, Hungary and France²⁶.

The North American wood pellet production (USA & Canada) was estimated to be at about 6.2 million tons for 2009²⁸. Although pellet production capacity in Canada is greater as in the United States, there is hardly an existing market for wood pellets inside the country and thus about 90 % of the Canadian wood pellets are exported overseas where they are used for large scale power production²⁸. In the United States about 80 % of the pellets produced are used within the country, for domestic heating in pellet stoves²⁸.

A strong potential growth is predicted both for the European and North American pellet market. The additional demand for biomass within the EU until 2020 will likely result in shortages within the EU and require more imports from Russia and/or overseas²⁶. The North American pellet market is less mature than the European

market, mainly due to lower energy prices and political conditions. Nevertheless there is a strong growth potential, both for residential as well as for the industrial market²⁸. With likely increasing prices for fossil fuels and electric power there is a good chance that some of the about 30 million homes in the Unites States which are today heated with electricity will switch to biomass heating²⁸. Regarding large scale applications, about 80 biomass fired power plants in 16 States were online in 2009 but unless they get subsidized they cannot compete with coal and gas fired power plants. The drive to reduce carbon dioxide emissions, however, has created opportunities for biomass in general and wood in particular²⁸. Other world regions with a strong potential to develop a pellet market are Russia, Brazil, Chile and New Zealand²⁹.

2. Pelletizing process

Mechanical densification of biomass is an established process technology that has been on the market for more than a century. The first patented biomass densification process was registered in 1880 by Mr. William Harold Smith in Chicago, Illinois⁸. It describes a process where saw dust is heated up to 150 °C, put in a strong mold and is compressed using a steam hammer. Biomass densification first became a commercial, large scale process in the second half of the last century, and was used to increase the handling properties of biomass both for energy production and animal feedstock. In North America, wood pellets came into existence in the 1970s with the primary purpose to resolve the energy crisis. They were mainly used by industrial, commercial and institutional sectors for heating. Residential consumers followed in 1983 when the first pellet stoves were introduced to the market²⁹. The European markets started later, with Sweden running at the forefront beginning about 1980 and then soon spread all over Europe²⁹. This development was initially driven by increasing prices for fossil fuels and good availability of residues from sawmills and pulp and paper industry. Political decisions aiming to reduce carbon dioxide emissions and a general environmental consciousness became important factors too^{16,29}.

Processing technology and product dimensions define the difference between pellets and briquettes. Pellets have in general a cylindrical shape and are about 6-25 mm in diameter and 3-50 mm in length³⁰ while briquettes are round or square sized with length/diameters of about 50-80 mm³¹. Especially in early studies from the 70s and 80s the terms “briquetting” and “pelletization” have been confused and the term briquettes has been used for pellets. The processes are very similar and have a lot of things in common, therefore, it is sensible to include and discuss both technologies within this work. In the context of this study all bodies that match the described pellet dimensions above, will be termed pellets. All bodies with greater dimensions are termed briquettes.

Pelletizing processes consist of multiple steps (Figure 2) that include raw material pre-treatment, pelletization and post-treatment. Pre-treatment technology steps depend a lot on the raw material characteristics and consist generally of size reduction, drying and conditioning. After pelletization, the pellets are transferred into a pellet cooler and screened for small particles¹³.

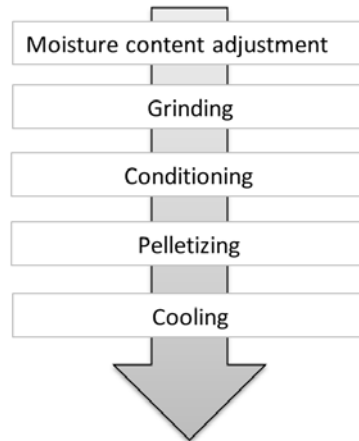

Figure 2. Process stages of biomass pellet production³².

2.1. Raw materials

Biomass feedstock for solid biofuels can be categorized into forestry, agriculture and waste-based materials, and they can be subdivided into primary sources (directly produced materials) or secondary sources (derived from other processes)³³. There has been a considerable amount of publications within the last years, mainly dealing with optimization of pelletization and briquetting processes. The raw materials studied range from wood species, such as pine³⁴⁻⁴², spruce^{1-3,34,37,42,43}, beech^{1-3,37,44}, oak^{38,39}, poplar³⁹, aspen⁴¹, salix⁴⁵, and fir⁴⁶, to agricultural residues, such as alfalfa²², barely⁴⁷⁻⁵⁰, canola⁵¹, oat⁵¹, wheat^{1,3,47,50-53}, rice^{54,55}, soybean⁵⁴, rye⁵⁶, reed canary grass²³, corn stover^{25,38,53,57,57-60}, corn cobs⁶¹, switch grass^{57-60,62-64}, big blue stem⁵³, sugar cane bagasse⁶⁵, cotton^{38,66}, olive residues⁶⁷ and peanut hulls⁶⁸ and also mixed residues⁶⁹.

2.2. Process parameters and modeling

Pellets are produced in a pellet mill that generally consists of a die with cylindrical press channels and rollers that force the biomass to flow into and through the channels. Due to the friction between the steel surface and the biomass in the press channel, a high back pressure is built up and heat is generated. The physical forces built up in the press channel of a pellet mill are crucial for understanding and optimizing the pelletizing process, and have been the subject of multiple studies^{1,2,37,44}. A die with press channels and roller(s) are the basic parts of a pellet mill. The die can either be in the shape of a ring or a flat plate as shown in Figure 3.

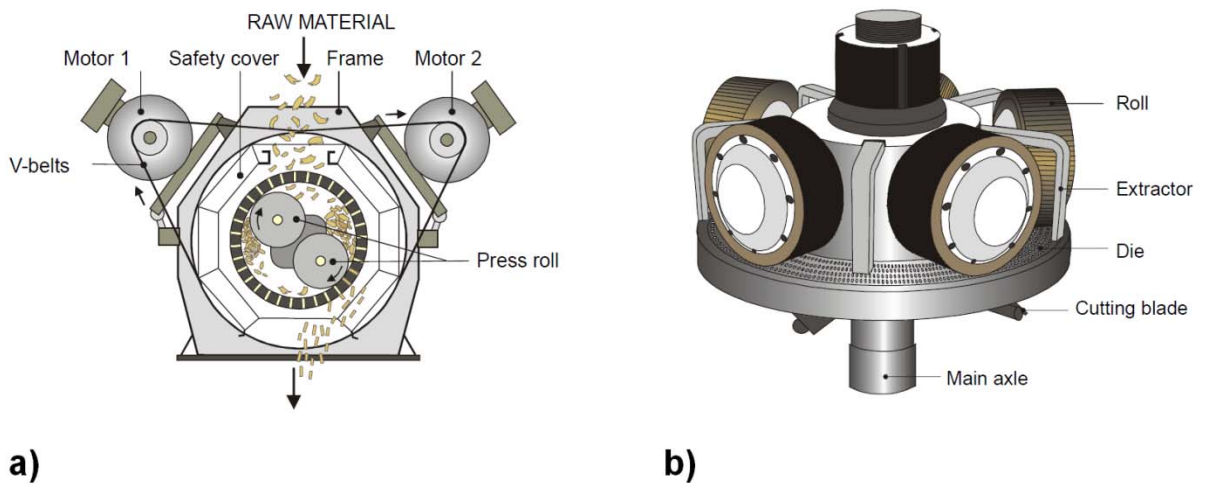

Figure 3. Typical pellet mill design a) ring die and b) flat die³¹.

Either the die or the rollers can be rotating, and due to that movement the biomass particles are squeezed into the openings of the press channel.

The pelletization process itself takes place in the press channel of a pellet mill and has been the subject of studies and modeling approaches^{1,2,37,41,44,70}. During pelletization the biomass particles are fed into the pellet mill. The basic parts of a typical ring die pellet mill are a die with press channels and (usually two) eccentrically installed rollers. The rollers are located in close proximity to the die. The biomass in the mill is squeezed between roller and die and forced to flow into the press channels. Every time the roller passes the channel a new amount of biomass is pressed into the channel as illustrated in Figure 4.

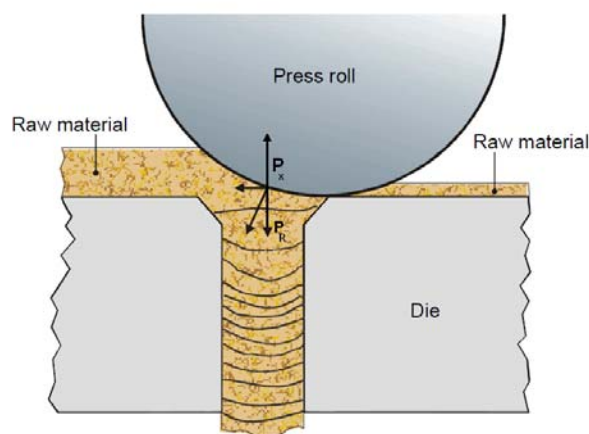

Figure 4. Assembly of a pellet in the press channel of a pellet mill (graphic modified based on Alakangas et al.³¹).

Studies have shown that the compression ratio c (length/diameter) of the press channel is one of the most influential parameters determining the magnitude of the pressure (P_x) generated in the press channel of a pellet mill^{1,37,44}. The pressure exerted by the rollers of the pellet press P_R is limited within a certain range (set by the size and motor power of the pellet mill). When P_x exceeds this range the press channels of the pellet mill will be blocked, since the rollers are not able to provide the necessary pressure to push the materials through the channels. The optimal magnitude of P_x is therefore a trade-off between the necessary pressure to produce stable pellets and the energy uptake by the pellet mill. High P_x increases the risk of fires due to heat development caused by friction as well as energy uptake of the pellet mill.

2.2.1. Key process parameters

P_x and its dependency on raw material characteristics i.e. species, moisture content, particle size, as well as process related parameters, such as temperature and press channel length have been investigated in detail in **Paper I**¹.

Moisture content

The effect of raw material moisture content on the pelletizing properties and product quality has been subject of several studies^{1,34,36,39,41,43,47,48,50,52,57,71-73}.

In these studies the moisture content was subject to variation and its impact on the pellet quality (durability or compression stability) was analyzed. There is a general difference between wood and herbaceous biomass resources. The optimum moisture content for wood species was found to be between 5 and 10 % (wt).

For beech 6 to 10 % (wt)^{1,40}, spruce about 10 % (wt)¹, olive 5 % (wt)⁷¹ and pine 6 to 8 % (wt)⁴⁰. The optimum moisture contents for the pelletization of grasses are significantly higher. For unspecified straw in general 10 to 15 % (wt)⁵⁰, Barley straw 19 to 23 % (wt)⁴⁸, wheat straw about 15 % (wt)^{1,52} and corn stover about 10 % (wt)⁵⁷. Increasing moisture contents above the optimum have been shown to have a negative influence on the pellet's mechanical properties^{1,40,48,57,71} and reduce the pellet density^{50,57}.

Apart from the quality of the densified product, the densification process itself is influenced by the moisture content. Andrejko and Grochwitz⁷² concluded from their studies that the energy consumption to compact ground lupine seeds into pellets was dependent on moisture content. They found out that the energy input necessary to compact the ground seeds to a constant volume decreased with an increasing moisture content within the range of 9.5 to 15.0 % (wt). Nielsen et al.⁴⁰ have shown that an increasing moisture content for pine and beech results in a decrease of the energy requirement for different components of the pelletizing process.

Temperature

The effect of temperature on biomass densification has been studied to great extent^{1,36,40,43,48,57,62}. Heat is generated during pelletization due to friction between biomass and the press channels of the pellet mill. Serrano et al.⁴⁸ have studied the heat distribution by taking thermo graphic images of a pellet press and found out that the temperature of a die under operation at stable conditions is about 90 °C while the temperature of the biomass is just about 70 °C and cooling quickly once it has been passed through the die (Figure 5).

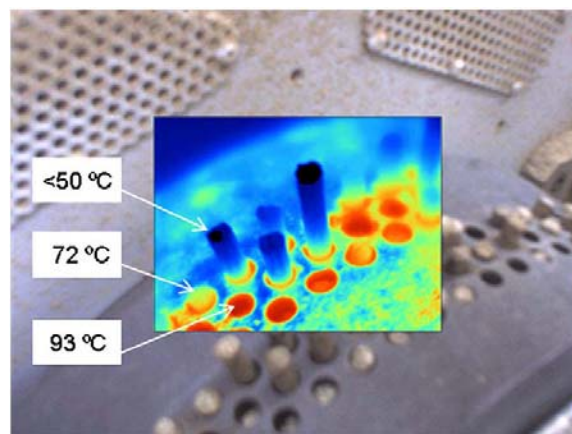

Figure 5. Thermographic image of a pellet press die⁴⁸.

The first studies of the temperature effects on biomass densification were conducted by Smith et al.⁵² in the late 1970s. They investigated the dependency of straw briquette density on the applied temperature within a range of 60-140 °C. They showed that the density increased with temperature until it reached 90 °C, while further increase did not result in density increase. They observed that the stability was enhanced and suggested that thin layers of waxes around the stem (cuticula) melt and solidify during this process and as such serve as an adhesive between individual straw fibers. Nevertheless several other studies suggest a negative effect of plant waxes on inter-particle bonding due to the formation of a weak boundary layer^{3,5,82,83}.

A study made by Stelte et al.⁴ (**Paper IV**) has shown that wheat straw waxes undergo a glass transition already at about 40-50 °C (below the temperature where density improvements were observed) while wheat straw lignins showed a strong transition in the range of 65-75 °C much closer to the observed improvements. Indeed several studies^{3,59,62} have suggested that lignin glass transition and subsequent flow and hardening result in an interpenetration of polymer chains from adjacent particles and thus in enhanced secondary bonding and high mechanical properties of a pellet.

Increasing mechanical properties of the pellets with increasing temperature were reported for spruce⁴³, corn stover⁵⁷, switch grass⁶², pine⁴⁰, olive⁷¹, beech⁴⁰ and wheat straw⁵. Furthermore it was reported that an increasing temperature reduces the

friction in the press channel of a pellet mill¹ and lowers the energy requirement for different components of the pelletizing process⁴⁰.

Particle size

Different studies have been made about the impact of particle size on the compaction properties of biomass^{1,36,47,48,57,74}.

Stelte et al.¹ (**Paper I**) have shown that the friction in the press channel of a pellet mill increases with decreasing particle size for beech particles. Regarding pellet quality, Kaliyan and Morey⁵⁷ have found out that decreasing particle size for corn stover grinds results in an increased briquette density. Similar results were observed by Mani et al.⁴⁷ who found that particle size significantly affects the pellet density for pellets made from barley straw, corn stover and switch grass, but not in the case of wheat straw. A study made by Serrano et al.⁴⁸ indicated opposite results. The difference between these studies was explained by the use of an industrial pellet mill instead of laboratory scale single pellet press units.

Jensen et al.⁷⁴ investigated different disintegration methods with the aim of determining particle size distribution in a biomass pellet using wet and dry disintegration methods. They suggest that wet disintegration combined with mechanical impact is the most suitable method to determine the internal particle size distribution of a biomass pellet.

Press channel dimensions

The diameter of a press channel varies according to the desired product diameter, usually between 6-25 mm³⁰. The press channel length and the ratio between length and diameter, the so called compression ratio (c), have been subject to multiple studies^{1,2,37,44,49,50,55,75}. Faborode and O'Callaghan⁵⁵ were the first to study the relationship between the compression ratio and the compaction pressure. They tested the impact of the compression ratio (between 0-17) on the pelletizing pressure of straw. Their data clearly shows an exponential correlation between the compression ratio and the pelletizing pressure. The physical forces acting on a pellet in the press channel of a pellet mill were further studied by Holm et al.^{2,37,44}. Their findings resulted in a pellet model that in combination with simple tests in a laboratory scale single pellet press allow an estimation of the pelletizing pressures at a given larger press channel length.

Colovic et al.⁷⁵ have studied the impact of the press channel length on the physical quality of cattle feed pellets and they concluded that an increasing press channel length resulted in higher mechanical properties of the pellets (pellet hardness test)

Pelletizing pressure

The pressure the biomass is exposed to during pelletizing and briquetting processes has a significant impact on the product density and durability as well as on the process

energy consumption and has therefore been subject of various studies^{1,47,50-52,57,62,71,76}. Studies have been made for straws from wheat^{47,51,52,62}, barley^{47,50,51}, canola⁵¹, alfalfa⁷⁶ and oat⁵¹. Other biomass residues tested were corn stover^{47,57}, switch grass^{47,57,62}, olive residues⁷¹ and wood¹. The biomass is compacted at different pressures and the resulting product density^{1,47,50-52,55,57,62}, mechanical properties^{57,62,71} or energy content⁵⁰ are compared. Regarding the product density, there is a very clear accordance between the studies that pellet and briquette density increases with an increasing pressure and that the dependency between pressure and density follows a saturation curve, indicating that the plant cell wall density is the upper limit that can be reached. Maximum applied pressures ranged from 50 MPa⁵⁰ up to 600 MPa¹ while most studies were somewhat in between. In general, the pellet density increases only incrementally at pressures above 50 to 100 MPa^{1,47,51}. The mechanical properties, compressive strength⁶² and durability^{63,71} improve with increasing pressure and follow a saturation curve, as already observed for the pellet density¹. Building up pressure by motor power either in a pellet mill or briquetting press consumes energy and it seems clear that, above a certain threshold which is somewhere above 100 MPa, additional energy put into the process mainly results in excess heat instead of increased pellet density and stability.

Biomass composition and additives

The effect of biomass constituents on the strength and durability of feed pellets have recently been reviewed by Kaliyan and Morey⁷⁷, who focused on the influence of starch, protein, fiber, fat and extractives on the biomass bonding properties. Although fuel pellets serve a different purpose and vary considerably in composition from pelletized fodder i.e. contain less starch, protein and fat, a lot of valuable information can be found in this study. Starch plasticizes in presence of heat and moisture in a process generally known as gelatinization which significantly increased the pellet durability⁷⁸. Proteins are, like starch, known to plasticize under heat and pressure and have been shown to increase the pellet strength⁷⁹. The fiber content of biomass has to be differentiated into water soluble and insoluble fibers. Soluble fibers generally increase the viscosity of the feed and have a positive effect on the pellet structure while insoluble fibers can entangle with each other⁸⁰. The stiffness and resilience of a fiber can be problematic during pelletization and large fiber sizes can result in weak spots where pellets fragment⁸¹. The presence of lipids in pellet feedstock results in a decrease of the pellet's mechanical properties⁷⁹, mainly due to inhibition of bonding properties of the water soluble compounds (hydrogen bonding)⁸¹. Results from those studies indicate the importance of thermal softening and plastic deformation, flow and subsequent hardening of biomass polymers during pelletization. In the case of fuel pellets from biomass, it has been shown that high extractives contents lower the friction in the press channel of a pellet mill^{1,5,39} and that high concentrations of extractives on the biomass particle surface can reduce the mechanical strength of densified biomass products^{3,5,82,83}.

Additives or binders may be added to improve the pellet's mechanical properties i.e. increase density and strength, improve the pelletizing process (throughput) or improve of moisture resistance¹³. Other reasons for additive addition is to improve the combustion properties i.e. ash melting point, slagging and corrosion⁸⁴.

Binders can be in liquid or solid form to improve the interparticle bonding. A large number of about fifty organic and inorganic compounds have been used in densified biomass products⁸⁵. In feedstock pellets a wide range of additives are used including molasses, starches, protein, modified cellulose, lignosulphate and anorganic clay minerals^{77,86,87}. A very common type of additive for wood pellets is lignosulphate that has recently been shown to increase the mechanical properties of wood pellets better than starch⁸⁸. Other additives used in wood pellets are paraffin, molasses, stearin and cellulose fibers¹³. It has to be noted that there are national differences about what additives are allowed in fuel pellets and the legislation in Denmark is, for example more restrictive than in Germany¹³. Stevens and Gardner⁸⁹ have recently made a study investigating the effect of two lignin types on fuel value, moisture content and quality. They concluded from their study that the lignin preparation will have a major impact on the feasibility of using lignin as an additive.

2.2.2. Process modeling

Many different aspects of biomass pelletization have been the subject of mathematical models. There are several different general approaches to model the compression of (biomass) powders and these have been reviewed extensively by Leuenberger and Rohera⁹⁰.

Kaliyan and Morey⁶⁰ have reviewed different constitutive and rheological models describing biomass densification processes and proposed a constitutive model for the densification of corn stover and switch grass. Their model characterized the biomass thermo mechanical properties through five model parameters (elastic modulus, strength coefficient, strain hardening exponent, viscous coefficient and frictional loss factor). The model parameters were affected by pressure, particle size, moisture content and temperature.

Holm et al.⁴⁴ have developed a pellet production model describing the pelletizing pressure variation along the press channels of the pellet mill die. The model is based on defining differential control volumes describing the forces acting on the pellet in the press channel (c.f. Equation 1). The pellet model describes the pelletizing pressure P_x as a function of P_{N0} (pre-stressing term), μ (sliding friction coefficient), ν_{LR} (Poisson's ratio), r (press channel radius) and x the length of the die channel:

$$P_x(x) = \frac{P_{N0}}{\nu_{LR}} (e^{2\mu\nu_{LR}x/r} - 1) \quad (\text{Equation 1})^{44}$$

However, Equation 1 contains three variable parameters (P_{N0} , μ and ν_{LR}) and having only one equation, it is not possible to fit all parameters in a single step, due to mutual correlations. Furthermore, values for μ and ν are not available in the literature for all

types of biomass and not available for different temperatures and moisture contents either. The material specific parameter P_{NO} can only be determined experimentally. To solve this problem (**Paper II**)² describes a procedure where the parameters μ , ν and P_{NO} are combined into two new parameters (U and J), that can be estimated based only on a few experimental trials using a single pellet press (Figure 6). The simplicity of this method allows faster testing of new types of biomass by easy estimation of the compression curves (P_x vs. c) up to compression ratios relevant for full-scale pellet mills.

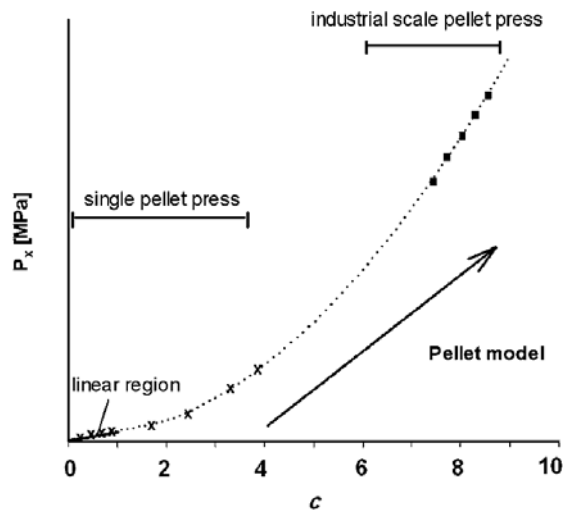

Figure 6. Schematic diagram showing how simple and fast testing with a single pellet press (SPP) unit in combination with modeling can predict the performance of an industrial pellet mill, where testing otherwise would be expensive and time-consuming². This data can be helpful when designing pelletizing processes for new types of biomass.

3. Bond formation in biomass pellets

The understanding of the bonding mechanisms between biomass particles within a fuel pellet or briquette is crucial for the production of high quality fuels. The bonding mechanisms in fuel pellets and briquettes have only been the subject of a few studies so far^{3,46,59}. Nevertheless a lot of knowledge can be transferred from related fields, such as pharmaceutical tableting, powder and agglomeration technology, fiber board manufacturing, wood plastic composites, wood welding and materials science in general.

One area of science that has been studied intensively during the last century is the production of pharmaceutical tablets. Tablet pressing of powder materials is therefore a well known process that has been studied intensively and has been subject of extensive reviews^{90,91}. In general, there are two important aspects to consider when pelleting granular materials and these are the behavior of the particle under pressure and secondly the interactions between the particles⁹². The pressure at a constant compression rate increases with time during densification processes as shown in the compression curve in Figure 7. In general the densification process can be separated into different stages i.e. particle rearrangement, elastic and plastic deformation and hardening⁸⁵.

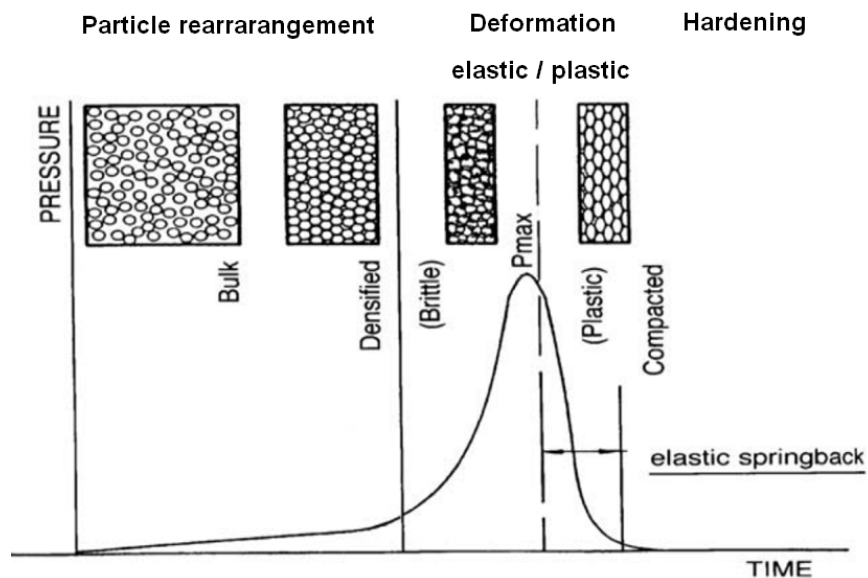

Figure 7. Powder compression curve⁸⁵.

According to Rumpf⁸⁰ and Pietsch⁸⁵, bonding forces between particles in compacted bodies can be classified into 1) solid bridges, 2) attraction forces between solid particles, 3) mechanical interlocking 4) adhesion and cohesion and 5) interfacial forces and capillary pressure. These bonding mechanisms have been identified and assumed also to be valid for densified forage and wood residues^{87,93}.

Mani et al.⁹⁴ have analyzed compression curves of various grasses and interpreted them. Initially the pressure builds up slowly because particles rearrange in a way that they fill less space. Furthermore air located in the pores between the particles is removed when pressing. With further compression of the materials, particles are getting in very close proximity to each other and short range bonding forces, i.e. van der Waals forces and electrostatic forces, make them adhere to one another. After a certain point no closer packing can be obtained this way and particles are pressed against each other, undergoing elastic and plastic deformation and fiber interlocking⁸⁵. In case of plant cells that contain a large inner volume (vacuole) filled with air (dried biomass) the cell structure breaks up and the vacuole is compressed. At the same time cell wall compounds (i.e. lignin and hemicelluloses) are expected to be released from the cell and to interact with surrounding particles⁹⁵. Due to the high temperature and pressure lignin softens and flows, resulting in interdiffusion and entanglement of polymer chains between adjacent fibers. This phenomenon has earlier been described as “solid bridge” formation⁵⁹ and is important for the pellet strength³. The density increases with pressure until it reaches a maximum which, in the case of plant biomass, can be expected to be close to the density of the plant cell wall¹.

Bond formation between wood particles has been intensively addressed in wood science and wood technology and knowledge can be transferred to pelletizing processes. Wood welding, like pelletization and briquetting, is a process where heat and pressure is applied to biomass resulting in bond formation. The mechanism behind friction welding of wood has been studied in great detail⁹⁶⁻⁹⁹. According to these studies, the amorphous wood polymers lignin and hemicelluloses melt and flow in a process termed the “ungluing” of wood cells and results in the formation of an “entanglement network of molten polymers” that solidifies subsequently into a “wood fiber entanglement network composite”¹⁰⁰. Kaliyan and Morey⁶⁰ have recently reviewed the densification mechanisms in solid biofuels in great detail. **Paper III**³ deals with the bonding mechanism in fuels pellets made from different biomass resources.

3.1. Role of lignin glass transition

The role of the lignin glass transition and plasticization during biomass processing has been approached in many studies in general^{96,101-106} and more specific for its influence on the stability of biomass pellets^{3-5,59}. With an increasing temperature the energy of the lignin molecule increases, consequently intermolecular bonds are weakened and bond rotation around covalent bonds occurs. The lignin becomes more flexible and passes from a glassy into a rubbery state. The temperature at which this transition is happening is the so called glass transition temperature (T_g) and depending on lignin composition and the presence of a plasticizer, i.e. water^{5,103,104}. The higher the temperature above the T_g , the greater and easier is the flow of these molecules. When passing the T_g , the inter-molecular bonding is reduced, while the chain mobility and the free volume is increased to such an extent that the polymer chain ends and the backbone are able to rotate around their own axis. As a consequence, the viscosity of a polymer passing from a glassy into a plastic state drops significantly, resulting in

pronounced flow characteristics. This enables the interdiffusion of polymer chain ends and segments between adjacent fibers, and the establishment of new secondary bonds and entanglements, once the polymer is cooled down below the T_g ^{102,105,106}. The idea of a softening point is naturally a somewhat simplified picture. In reality, the polymer backbone, chain ends, etc. are those of a heterogeneous material with a diverse chemical structure and a distribution of molar mass, chain length etc., and the transition occurs over a temperature range³. The T_g for wheat straw lignin has been identified under dry and moist conditions (8% wt water content) to be at about 53-63 °C⁴, while the T_g for spruce lignin was found to be significantly higher at about 91 °C⁴. Pressing above the lignin T_g improves the pellet's mechanical properties⁵ and also reduces friction in the press channel.

Paper IV⁴ and **Paper V**⁵ study the lignin glass transition and its role on the pelletizing process in detail.

4. Recent trends and developments

4.1. Torrefaction

Some properties of biomass are inconvenient for its utilization as fuel in combustion and gasification processes i.e. its high oxygen contents, low calorific value, hydrophilic nature, and high moisture content¹⁸. Apart from that, its fibrous and tenacious structure and inhomogeneous composition makes biomass even more challenging and energy intense to process¹⁸. Numerous studies have shown that torrefaction changes the biomass properties¹⁰⁷⁻¹²⁰. Torrefaction is a thermal pre-treatment process that in literature is also referred to as roasting, mild pyrolysis or high temperature drying. The biomass is heated up to 200-300 °C in absence of oxygen reducing the fibrous structure and tenacity of the biomass and increasing its mass specific calorific value¹⁸. During torrefaction the biomass is partly decomposed and low molecular organic volatile compounds evaporate from the biomass¹¹³. This results in a decrease of mass while the initial energy content is slightly reduced. However as a consequence, the energy density of the biomass is increased, making it more attractive as a fuel¹⁸.

Torrefaction is therefore used to convert various types of lignocellulosic biomass into an energy dense homogeneous solid. The volatiles can be subdivided into condensable and non-condensable compounds. Condensable compounds are mainly water and acetic acid, non-condensables consist mainly of carbon mono- and dioxide¹¹³. Furthermore, biomass polymers i.e. hemicelluloses, cellulose and lignin are degraded and/or transformed¹²¹. The most reactive compounds are hemicelluloses. Xylan was found to start to decompose quickly at about 200 °C, resulting in high weight loss of the biomass. Cellulose degradation starts slowly at about 270 °C but accelerates noticeably at temperatures above 300 °C¹¹². Rousset et al.¹²² have studied the thermal degradation of lignin under torrefaction in great detail and concluded that lignins are more resistant to prolonged heat treatment than polysaccharides and that lignin undergoes intense structural transformations during torrefaction, mainly cleavage and recondensation reactions. Torrefaction improves the combustion properties, since higher combustion rates can be achieved while reducing smoke emissions at the same time¹¹⁵. Arias et al.¹¹⁰ and Repellin et al.¹¹⁹ investigated the grindability of torrefied wood and both grinding energy and resulting particle size of the product decreased with torrefaction. Torrefaction also increases hydrophobicity, further increasing the effective fuel value, protecting it from microbiological degradation, and easing storage. Torrefaction is used as a pre-treatment to produce fuel for gasification and co-firing processes¹⁸.

4.2. Pelletization of torrefied biomass

Recently torrefaction has been combined with pelletization and so far only a few studies have been published about the pelletizing properties of torrefied biomass^{6,7,18,62,123}. The results indicate that pelletization of torrefied biomass is somewhat more challenging than conventional wood pellet production and the resulting quality is subject of variation depending on torrefaction conditions. Stelte et al. (**Paper VI and VII**)^{6,7} have investigated the pelletizing properties of torrefied spruce⁶ and wheat straw⁷. The results indicate that the friction in the press channel of a pellet mill increases with increasing torrefaction temperature and that the pellet's mechanical properties and density decrease with increasing torrefaction temperature. Decreasing mechanical properties can be beneficial when it comes to comminuting biomass pellets to dust prior firing i.e. conventional coal mills might suffice but maybe disadvantageous during transportation and handling. Therefore, a compromise between good grindability and sufficient stability during pellet handling has to be found. The studies^{6,7} indicate that torrefaction temperatures of about 250-275 °C result in stable pellets of high energy density and favorable mechanical properties during size reduction and milling processes.

Pelletizing processes today are usually limited to one biomass type. This has some drawbacks, since it would be advantageous to use one type of mill for many raw materials depending on variation in price and availability due to season and climate. Torrefaction could be used to produce a homogeneous blend of various raw materials and thus increase flexibility of raw material usage^{18,123}.

5. Summary of appended papers

The aim of the present PhD study was to continue pellet research based on the outcomes of the previous studies, which were conducted within our research group at Risø-DTU during the years 2005 to 2007 to gain a wide knowledge about biomass pelletization processes¹²⁴. During this study, a pellet production model was developed which described the variation of the pelletizing pressure along the press channel of a pellet press. Equations based on differential control volumes were set up to describe the forces acting on the pellet in the matrix. Important model parameters were the sliding friction coefficient, the ratio of compression, and the material-specific parameters, such as the elastic modulus and Poisson's ratio. Model calculations showed how the variation in the model parameters significantly changed the necessary pelletizing pressure. Using typical material parameters of beech and pine, it was illustrated why beech, in accordance with the experimental test results, was more difficult to pelletize than pine⁴⁴. The model gave a theoretical explanation of how the biomass-specific parameters, such as the friction coefficient and Poisson's ratio, influenced the pelletizing pressure. The model showed that the pelletizing pressure increases exponentially as a function of the channel length³⁷. To extend and utilize those results, it was necessary to investigate other aspects of pelletization, such as raw materials and process-related factors, i.e. moisture content, species, composition, temperature, particle size, press channel length, as well as the bonding forces which keep a biomass pellet together.

The first study (**Paper I**¹) was based on and motivated by the results from the previous research project^{37,44,124}, which had shown an exponential correlation between press channel length and pressure built up in the channel. However, it did not investigate the impact of other processing parameters, such as raw material type, pellet length, temperature, moisture content, and particle size on the pressure built up in the press channel. The results from **Paper I**¹ confirmed the exponential increase of the pelletizing pressure with channel length and were in good accordance with the suggested mathematical model. Furthermore, it was demonstrated that the rate of pressure increase was dependent on biomass species, temperature, moisture content and particle size. It was also shown that increasing the temperature resulted in a decrease of the pelletizing pressure. Infrared spectra taken from the pellet surface indicated the presence of hydrophobic extractives on the surface of pellets produced at higher temperatures. The extractives act as lubricants, which lower the friction between the biomass and the press channel walls. The effect of moisture content on the pelletizing pressure was dependent on the raw material species. Different particle size fractions, from below 0.5 mm up to 2.8 mm in diameter, were tested, and it was shown that the pelletizing pressure increased with a decreasing particle size due to an increased area of contact. The impact of pelletizing pressure on pellet density was determined, and it was shown that a pelletizing pressure above 200 MPa resulted in only a minor increase in pellet density.

The outcome of this study resulted in the question of how this data can be used to optimize existing and develop new pelletizing processes based on various types of raw material. At present, most processes are developed on a trial-and-error base and often require expensive and time-consuming trial-and-error experiments. The idea came up that a better prediction of the pelletizing behavior of different biomass types could be realized by a further development of the earlier proposed pellet model^{37,44}, and to combine it with a series of simple laboratory tests using a single pellet press. The second study (**Paper II**²) showed how the existing pellet model could be simplified by reducing the number of unknown variables from three to two, and how they can be determined experimentally by means of fast and simple single pellet press trials. The model was used to extrapolate the data from laboratory to production size scale.

The first two studies dealt with processing parameters and their influence on the pelletizing process, and introduced the single pellet press unit as a tool that can be used to simulate large scale pelletizing processes and how this data, in combination with a model, can be used for a better estimation of a process design. The other important aspect of designing a pelletizing process, the product quality, i.e. the bonding strength of a biomass pellet, and how it can be determined and characterized, has been addressed in the third study (**Paper III**³). It investigates bonding and failure mechanisms within a biomass pellet that need to be understood in order to be able to optimize any process. The mechanical strength and integrity of a biomass pellet were determined and correlated to the quality and mechanisms of inter-particle bonding. The raw materials used were beech, spruce and straw, which represented the most common biomass types used for fuel pellet production, i.e. hardwoods, softwoods and grasses, respectively. The results showed that the compression strengths of the pellets were generally higher for pellets produced at higher temperatures, and much higher for wood pellets than for straw pellets. Scanning electron microscopy of the beech pellet's fracture surfaces pressed at higher temperatures showed areas of cohesive failure, thus indicating high energy failure mechanisms, which are most likely due to lignin and hemicelluloses flow and inter-diffusion between macromolecules of adjacent fibers. These were absent in both spruce and straw pellets. Infrared spectroscopy of the fracture surfaces of the straw pellets indicated high concentrations of hydrophobic extractives, which were most likely responsible for their low compression strengths, due to the presence of a chemical weak boundary layer, which limited the adhesion mechanism to van der Waals' forces. Electron micrographs indicating interfacial failure mechanisms support these findings. Infrared spectra of the fracture surface of wood pellets, which are pressed at elevated temperatures, showed no signs of hydrophobic extractives. It has been demonstrated that both temperature and chemical composition, i.e. the presence of hydrophobic extractives, have a significant influence on the bonding quality between biomass particles during the pelletizing process.

Since the temperature and moisture content have been identified as important process parameters and because there have been strong indications for the glass transition of the biomass polymers having a strong effect on the pellet quality, it seemed logical to focus on the role of lignin glass transition. The fourth and fifth study

(Paper IV⁴) and **(Paper V⁵)** were made to address this question and investigate the role of lignin glass transition during the pelletization of wheat straw.

During the first part of this investigation **(Paper IV⁴)**, the thermal transition of the amorphous polymers in wheat straw were investigated by means of dynamic mechanical thermal analysis (DMTA). The study included both natural and solvent extracted wheat straw in moist (8 to 9 % (wt) water content) and dry conditions, and the results were compared to spruce samples. Under these conditions, two transitions arising from the glass transition of lignin and hemicelluloses have been identified. Key transitions attributed to the softening of lignin were found at 53, 63 and 91 °C for moist samples of wheat straw, extracted straw and spruce, respectively. Transitions for hemicelluloses were determined at 2, -1 and 5 °C, respectively. Differences are most likely due to different compositions of lignin and hemicelluloses from straw and spruce and structural differences between the raw materials. The high wax content in wheat straw resulted in a transition at about 40 °C, which was absent in solvent extracted wheat straw samples and spruce. This specific transition was further investigated and confirmed by differential scanning calorimetry (DSC) to be that of wax from wheat straw. Information about the thermal transitions is of great importance for the utilization of wheat straw in pelletizing.

Once the transitions had been identified, it was obvious to study the effect of lignin glass transition on the pelletizing properties of wheat straw **(Paper V⁵)**. Pellets from wheat straw and solvent extracted wheat straw were produced at 30 and 100 °C, and then compared. It was shown that pellets pressed below the lignin glass transition temperature had both lower density and lower compression strength, as well as a tendency to expand in length after the pelletizing process. At low temperatures, surface extractives have a lubricating effect and reduce the friction in the press channel of a pellet mill, while there was no such effect observed at elevated temperatures. Fuel pellets made from extracted wheat straw have a slightly higher compression strength, which might be explained with a better inter-particle adhesion in the absence of hydrophobic surface waxes.

Studies one to five provide a wide range of methodology, which is a kind of toolbox that can be used for studying the pelletizing properties of new types of biomass. The sixth and seventh study **(Paper VI⁶)** and **(Paper VII⁷)** applied the knowledge gained from the previous studies and used it to investigate the pelletizing properties of torrefied spruce **(Paper VI⁶)** and wheat straw **(Paper VII⁷)**. Those have earlier been shown to be challenging raw materials for pelletizing processes. The sixth study **(Paper VI⁶)** focused on the pelletizing properties of spruce torrefied at 250, 275 and 300 °C. The changes in composition were characterized by infrared spectroscopy and chemical analysis. The pelletizing properties were determined using a single pellet press, and pellet stability was determined by compression testing. The bonding mechanism in the pellets was studied by fracture surface analysis using scanning electron microscopy. The composition of the wood changed drastically under torrefaction, with hemicelluloses being most sensitive to thermal degradation. The chemical changes had a negative impact, both on the pelletizing process and the pellet properties. Torrefaction resulted in higher friction in the press channel of the pellet press and low compression strength of the pellets. Fracture surface analysis revealed a cohesive

failure mechanism due to strong inter-particle bonding in spruce pellets, as a result of a plastic flow of the amorphous wood polymers, which formed solid polymer bridges between adjacent particles. On the other hand fracture surfaces of pellets made from torrefied spruce possessed gaps and voids between adjacent particles due to a spring back effect after pelletization. They showed no signs of inter-particle polymer bridges, thus indicating that bonding is most likely limited to Van der Waals' forces and mechanical fiber interlocking.

The seventh study (**Paper VII**⁷) investigated the effect of torrefaction on the chemical composition of wheat straw and its pelletizing properties. Wheat straw was torrefied at 150, 200, 250 and 300 °C for two hours in an inert (nitrogen) atmosphere. The surface of the resulting products, analyzed by means of attenuated total reflectance – Fourier transform infrared spectroscopy, indicated degradation of hemicelluloses and cellulose with an increasing torrefaction temperature. The absorption bands of lignin changed with an increasing torrefaction temperature suggesting structural changes. Contrary to our expectations, the extractive content remained relatively stable up to high torrefaction temperatures. Standard fiber analysis was used to confirm these results. The torrefied wheat straw was tested for water absorption properties and heating value. The ability to absorb water decreased with an increasing torrefaction temperature and the energy density increased. Pelletizing tests using a single pellet press indicated an increasing friction for torrefied biomass, especially for material treated at 300 °C. The pellets' mechanical properties were evaluated by means of compression testing, which showed decreasing compression stability for pellets made from torrefied wheat straw. No stable pellets could be formed from straw torrefied at 300 °C.

The outcome of the studies can be used in several ways. First of all, the developed methodology (single pellet press tool in combination with model, and mechanical testing of the pellets) allows a fast and relatively simple way to study the pelletizing properties of all kinds of biomass before starting time- and cost-intensive pilot trials. More advanced techniques, such as electron microscopy, chemical analysis, infrared spectroscopy and dynamic mechanical thermal analysis, have been developed to study the biomass properties as well as to understand the bonding mechanisms.

The results from the different studies have shown that there is a relatively narrow window of processing parameters to produce stable pellets and that this window varies with biomass type. The data can be used to build upon and form a solid base for further investigations to improve the pellet quality and to reduce process costs.

6. Conclusions

The present study investigated several different aspects of biomass pelletization processes. The literature review at the beginning has shown that there is a growing demand for biomass for heat and power production, and that pelletizing processes ease biomass handling and conversion into heat and power. Research in this area has increased recently, and while for a long time the major focus of scientific studies had been on process optimization, many recent studies investigated the more fundamental aspects of biomass pelletization, such as bonding mechanisms, physical forces acting on the biomass during pelletization, thermo mechanical properties of raw materials, raw material-related differences and pre-treatment processes. The present study focused individually on different aspects of biomass pelletization, i.e. processing, modeling, and bonding mechanisms as well as new types of raw materials (**Paper I – VII¹⁻⁷**).

Bringing together the results obtained from all those studies, it becomes obvious that fuel pellet production from biomass is more complex than most people would expect. Even today, most pelletizing processes are results of trial-and-error experiments and individual experience, rather than being science-based. The present study has shown that many raw material variables such as species, chemical composition, and moisture content, as well as processing conditions, such as press channel dimensions, temperature, particle size and pre-treatment conditions, have an important influence on process and product quality. Providing a view from different perspectives on pelletizing processes and its most important aspects is probably the main outcome of this study. The methodology, introduced in this study, i.e. a single pellet press tool combined with mechanical testing and a mathematical model, and for more advanced studies, chemical analysis methods, fracture surface and spectroscopic methods, defines a broad toolbox that can be used for future “pellet research”.

From the first study (**Paper I¹**), it can be concluded that there is a narrow window of optimal processing parameters for each biomass type, i.e. press channel length, temperature, moisture content and particle size, and that small changes, like a couple of percent higher moisture content or a few millimeter longer press channel, can have a great effect on the process (i.e. energy uptake of the pellet mill) or pellet quality (mechanical properties). The tool developed and used for this study has been demonstrated to be a good model for pelletizing tests. The second study (**Paper II²**) has shown how the data obtained from single pellet press trials can be used to predict the parameters for production scale processes, and also explains the mathematical correlation of different biomass properties, i.e. Poisson ratio, friction coefficient, with process parameters (pelletizing pressure). The earlier developed pellet model⁴⁴ was simplified by introducing artificial parameters (U and J) for an easier application and connection of obtained data from the pellet press and model data.

From the first study, it was shown that the pellet quality (mechanical strength) was influenced by process and raw material parameters. A more detailed study of bonding and failure mechanisms of fuel pellets made from beech, spruce and straw revealed

that “good bonding” is the precondition for high mechanical stability of a pellet, and that the quality of bonding can be observed by means of fracture surface analysis. The results from the third study (**Paper III**³) indicate that an elevated temperature results in polymeric flow of biomass polymers and the formation of solid bridges between adjacent particles. This study also showed that the chemical composition of the biomass, especially surface extractives (i.e. wheat straw cuticula) and lignin properties (i.e. degree of substitution and glass transition), are likely to have an important effect. With the obtained data, it could be explained why pellets made from wheat straw are less mechanically stable than wood pellets. To obtain further knowledge and to confirm the hypothesis from that study, two additional studies were made. Study four (**Paper IV**⁴) investigated the thermo mechanical properties of wheat straw amorphous polymers (i.e. hemicelluloses and lignin) and the fifth study (**Paper V**⁵) investigated the effect of the lignin glass transition and surface waxes on pellet stability and bond formation. The studies indicated that the lignin glass transition is a key parameter in pellet production, and that its temperature is dependent on species (lignin structure) and moisture content (plasticizing effect of water). The presence of surface waxes on biomass particles resulted in decreased pellet stability. Waxes probably form a separate phase around particles, preventing lignin and carbohydrate molecules from different particles from interacting and forming hydrogen bonds or polymer bridges. Since thermo-chemical upgrading of biomass (torrefaction) is a widely discussed topic in the bioenergy sector right now and because of the request of power producers to obtain a more “coal-like” biomass fuel, studies six and seven (**Papers VI and VII**^{6,7}) were conducted to investigate the pelletizing properties of torrefied biomass. The study was based on the toolbox developed during the previous studies and only the biomass type, torrefied spruce (**Paper VI**⁶) and torrefied straw (**Paper VII**⁷) were modified. The obtained data showed that combined torrefaction and pelletization can result in a biomass fuel with higher energy density, lower water absorption, and better resistance to microbiological decay. The mechanical properties of torrefied pellets are different (i.e. more brittle) than conventional wood pellets, meaning that it is easier to grind and could more likely be used in existing power plant infrastructures, i.e. conventional coal mills. Nevertheless, it is important to notice that if the biomass has been exposed to high temperatures for longer times, the resulting polymer degradation prevents the formation of stable bonds between biomass particles and therefore lowers the pellet’s mechanical integrity. The introduced methodology and results will be useful for further investigations regarding the pelletizing properties of unknown/untried biomass resources.

7. Application of results

Today's process development is based on experience and trial-and-error experiments, which can be both cost and time consuming. The process design of a pellet plant is usually optimized for a certain type of raw material and can only to a limited extent be adjusted to other raw materials. Already small changes of the raw material properties can have a large impact on the process economy, i.e. throughput, energy consumption and/or the product quality. Today's understanding of pelletizing processes is limited and based on experience and half-knowledge, rather than on fundamental understanding of what and how different parameters influence the formation of a pellet. This knowledge is important, especially when it comes to a more competitive and diverse biomass market in the future. The variety of raw materials used for fuel pellet production will increase in the future, and this will require the adjustment of existing production lines or development of new concepts. A prominent example of how difficult it can be to design a pelletizing process, is the production of pellets from torrefied biomass that has swallowed both time and money.

The present study has addressed the necessity to study the fundamentals of biomass pelletization in great detail, to improve the way process development can be carried out in the future. Although some of the results may seem rather academic and not directly applicable for process development, they mark milestones on a way to make a process development more efficient.

The first study (**Paper I¹**) introduced the utilization of a single pellet press tool, a rather simple laboratory press, which allows to control and test all kinds of process parameters, such as temperature, moisture content, particle size, pressure, various raw material compositions and additives. Test can be done in the laboratory, and only a few grams of material are necessary for testing. The press cannot simulate all aspects of a "real life" pellet mill but can give an indication about how different process parameters affect the product quality and friction (pressure) built up in the press channel. In a production size pellet mill, some process parameters are connected and dependent on each other; for example, friction and temperature depend on the press channel length. Other parameters such as the particle size or moisture content are easier to adjust. The results obtained with a single pellet press tool will become useful when setting up a pilot scale test, i.e. allowing a more efficient testing, since many parameters have been tested already in advance on a small scale.

The analytical methods developed in **Paper I¹** have been used to monitor and to understand what is going on with the biomass when it is heated and pressed in the press channels of a pellet mill. The results have shown that extractives migrate to the pellet surface, reducing the friction within a press channel and thus reducing the energy uptake of the mill. Furthermore, it has been shown that there are species related differences and that particle size and moisture content play an important role. Another important finding was the influence of the press channel length (pellet length) on the pelletizing pressure. Here it was shown that the dimensions of a press channel i.e. length and diameter are very important factor when setting up a process. A change

of a few millimeters can make a big difference with respect to energy uptake, throughput, and pellet quality. This knowledge is important for choosing the right die. This problem was further studied in **Paper II**², where the data from the single pellet press tool was used in combination with a mathematical model to estimate pelletizing properties in a production size pellet mill. The model is based on two parameters (U and J) that can easily be determined by conducting a few experiments at low compression ratios. The model is used to scale up the data from a single pellet press to conditions in a production size pellet mill (large compression ratio). Based on those results it is possible to extrapolate how a material behaves in a production size pellet mill. At present we are investigating whether the extrapolated data is correct, and this work is expected to be finalized soon. Secondly, **Paper II**² investigated the temperature dependency of the two model parameters (U and J). The results have shown that when one of the parameters (U) is set to vary linearly with temperature, while the other parameter (J) is kept constant, the experimental data fits the model reasonably well. Based on this result it is possible to formulate a hypothesis about the temperature dependency of the underlying model parameters (friction coefficient, Poisson ratio and pre-stressing factor)

Almost no detailed studies have been made about the bonding mechanisms within a biomass pellet so far. This is of great importance, since many types of raw materials are difficult or impossible to pelletize, without really knowing the reason for the unfavorable behavior of the biomass. **Paper III**³ shows how biomass can be characterized, and how those characteristics can be linked to its pelletizing properties. The developed tool box include: chemical analysis, single pellet press tests, determination of the pellets' compression strength and fracture surface analysis, which is a widely applied tool in materials science. The outcome of the study has shown that species specific features, i.e. the presence of a wax layer (cuticula) on the plant surface have a strong impact, both on friction as well as on the bonding strength. Lignin and extractives were identified as important factors affecting the strength of a biomass pellet. This can explain why certain raw materials, i.e. straws are more difficult to pelletize than wood.

A more fundamental study about the thermal softening of lignin was made with **Paper IV**⁴. Although it does not seem to be directly applicable for pelletization processes, it gives an indication for a minimum temperature that is required for good bonding, and points out the importance of the water content. Water acts as a plasticizer reducing the softening temperature of the lignin in the biomass. The paper shows, why the moisture adjustment is such an important parameter for pellet production. Is a raw material too dry, it cannot be pelletized, since its lignin does not soften and as such does not form bonds between the biomass particles. Furthermore, the study is interesting from an academic point of view, since no one has determined the glass transition temperature of wheat straws amorphous polymers before.

Paper V⁵ was a more straight forward study about the influence of lignin softening and wax content on the pelletizing process. The results show the effect of temperature on bonding strength and explain why the pelletizing temperatures should be above the softening temperature of lignin. Furthermore, does it show the negative effect of wheat straw waxes on the leave surface (cuticula) on the bonding properties.

Secondly, waxes were shown to reduce the friction in the press channel of a pellet mill. Probably it will not be an economical feasible option to remove waxes from the biomass surface as it was done in the study but it might be an option to mix different types of biomass to optimize the pelletizing properties.

Paper VI and VII^{6,7} address the pelletization of torrefied biomass. Pelletization of torrefied biomass is difficult due to the low moisture content and the thermal degradation of the biopolymers, resulting in an increase of the softening temperature above the friction induced pelletizing temperature. Dehydration reactions result in a loss of hydroxyl groups, and as such a reduction of possible hydrogen bonding sites. The thermal degradation of hemicelluloses change the tenacious and flexible biomass fibers, into brittle and stiff ones that break and disintegrate easily when exposed to mechanical forces. Dust and fines are formed, which complicate the handling and processing properties of the torrefied biomass. The results from this study have shown the relation between the thermal degradation of the biopolymers, and how this affects the pelletizing properties and the pellet stability. The study should not be understood as a process optimization but more as a general study, which explains why the bonding and pelletizing properties decrease during torrefaction. Those results can be helpful for further optimization studies or for explaining the results/observations made in earlier studies.

8. Outlook

The main future issues in biomass pellet production are the sustainable and price-competitive production of pellets, for an increasing industrial and domestic pellet market that has high demands on pellet quality and combustion properties. Big trends right now are to combine torrefaction and pelletization processes, and to introduce a broader base of raw materials, i.e. agricultural residues, energy grasses and mixed biomass resources.

Pretreatment processes, like torrefaction, unify the biomass and result in a rather homogeneous product, compared to what is used as raw materials. Therefore, it might be an ideal pre-treatment for utilizing different biomass types, without the need of adapting the pelletizing process to the different raw materials used. Nevertheless, the combination of torrefaction and pelletization adds an extra dimension to process optimization, and the establishment of a cost-competitive process resulting in high quality pellets is challenging. There have been some major breakthroughs of European and North American pellet producers recently and large-scale production of torrefied pellets has just begun on a commercial scale.

A global pellet market requires global standards for biomass production as well as for pellet quality. The definition of globally sustainable criteria is particularly important, since it will have a great impact on how biomass is produced and harvested and whether it can contribute positively to the reduction of green house gas emissions and conserving ecosystems.

References

- (1) Stelte, W.; Holm, J. K.; Sanadi, A. R.; Ahrenfeldt, J.; Henriksen, U. B. Fuel pellets from biomass: the importance of the pelletizing pressure and its dependency on the processing conditions. *Fuel*. 2011, 90, 3285-3290.
- (2) Holm, J. K.; Stelte, W.; Posselt, D.; Ahrenfeldt, J.; Henriksen, U. B. Optimization of a multiparameter model for biomass pelletization to investigate temperature dependence and to facilitate fast testing of pelletization behavior. *Energy & Fuels*. 2011, 25, 3706-3711.
- (3) Stelte, W.; Holm, J. K.; Sanadi, A. R.; Barsberg, S.; Ahrenfeldt, J.; Henriksen, U. B. A study of bonding and failure mechanisms in fuel pellets from different biomass resources. *Biomass & Bioenergy*. 2011, 35, 910-918.
- (4) Stelte, W.; Clemons, C.; Holm, J. K.; Ahrenfeldt, J.; Henriksen, U. B.; Sanadi, A. R. Thermal transitions of the amorphous polymers in wheat straw. *Industrial Crops and Products*. 2011, 34, 1053-1056.
- (5) Stelte, W.; Clemons, C.; Holm, J. K.; Sanadi, A. R.; Shang, L.; Ahrenfeldt, J.; Henriksen, U. B. Fuel pellets from wheat straw: The effect of lignin glass transition and surface waxes on pelletizing properties. *Bioenergy Research*. doi:10.1007/s12155-011-9169-8, Published online.
- (6) Stelte, W.; Clemons, C.; Holm, J. K.; Sanadi, A. R.; Shang, L.; Ahrenfeldt, J.; Henriksen, U. B. Fuel pellets from torrefied spruce. *Biomass & Bioenergy*. 2011, 35, 3690-3698.
- (7) Stelte, W.; Nielsen, N. P. K.; Sanadi, A. R. Pelletizing properties of torrefied wheat straw. *World Sustainable Energy Days – European Pellets Conference 29.Feb-2. Mar 2012, Wels, Austria*. Accepted for presentation.
- (8) Smith, W. H. US Patent 233887, 1880.
- (9) Anonymous. Web of Science, Science Citation Index., Database accessed October 2011. www.webofknowledge.com. Thomsen Reuters, New York.
- (10) Anonymous. Key world energy statistics 2010. International Energy Agency (IEA), Paris, 2011.
- (11) Berner, R. A. The long-term carbon cycle, fossil fuels and atmospheric composition. *Nature*. 2003, 426, 323-326.
- (12) Dukes, J. S. Burning buried sunshine: Human consumption of ancient solar energy. *Climatic Change*. 2003, 61, 31-44.
- (13) Obernberger, I.; Thek, G. In: *The pellet handbook - The production and thermal utilisation of biomass pellets*; Earthscan: London, 2010.
- (14) Tolon-Becerra, A.; Lastra-Bravo, X.; Bienvenido-Barcena, F. Proposal for territorial distribution of the EU 2020 political renewable energy goal. *Renewable Energy*. 2011, 36, 2067-2077.
- (15) Sipilä, K.; Mäkinen, T.; Wilén, C.; Solantausta, Y.; Arasto, A.; Helynen, S.; den Uil, H.; Vehlow, J. S., H.; Gabrielle, B.; Peck, P.; Rogulska, M. *Bioenergy in Europe - Implementation of EU directives and policies relating to bioenergy in Europe and RD&D priorities for the future*. VTT Technical Research Centre of Finland: Espoo, 2008.

- (16) Bauen, A.; Berndes, G.; Junginger, M.; Londo, M.; Vuille, F.; Ball, R.; Bole, T.; Chudziak, C.; Faaij, A.; Mozaffarian, H. Bioenergy – a sustainable and reliable energy source: A review of status and prospects. International Energy Agency (IEA):Paris, 2009.
- (17) Rosillo-Calle, F. In: Overview of bioenergy; Rosillo-Calle, F., Hemstock, S., De Groot, P. and Woods, J., Eds.; The biomass assessment handbook; Earthscan: Oxford, 2007.
- (18) van der Stelt, M. J. C.; Gerhauser, H.; Kiel, J. H. A.; Ptasinski, K. J. Biomass upgrading by torrefaction for the production of biofuels: A review. Biomass & Bioenergy. 2011, 35, 3748-3762.
- (19) Dunnett, A. J.; Shah, N. Prospects for bioenergy. Journal of Biobased Materials and Bioenergy. 2007, 1, 1-18.
- (20) Gerbens-Leenes, W.; Hoekstra, A. Y.; van der Meer, T. H. The water footprint of bioenergy. Proceedings of the National Academy of Science of the United States of America. 2009, 106, 10219-10223.
- (21) Schubert, R.; Schellnhuber, H. J.; Buchmann, N.; Epiney, A.; Grießhammer, R.; Kulesa, M.; Messner, D.; Rahmstorf, S.; Schmid, J. In: Future bioenergy and sustainable land use; Earthscan: London, 2009.
- (22) Adapa, P. K.; Tabil, L. G.; Schoenau, G. J.; Crerar, B.; Sokhansanj, S. Compression characteristics of fractionated alfalfa grinds. Powder Handling & Processing. 2002, 252-259.
- (23) Larsson, S. H.; Thyrel, M.; Geladi, P.; Lestander, T. A. High quality biofuel pellet production from pre-compacted low density raw materials. Bioresource Technology. 2008, 99, 7176-7182.
- (24) Robbins, W. C. Density of wood chips. Journal of Forestry. 1982, 80, 567.
- (25) Sokhansanj, S.; Turhollow, A. F. Biomass densification - Cubing operations and costs for corn stover. Applied Engineering in Agriculture. 2004, 20, 495-499.
- (26) Sikkema, R.; Steiner, M.; Junginger, M.; Hiegl, W.; Hansen, M. T.; Faaij, A. The European wood pellet markets: current status and prospects for 2020. Biofuels Bioproducts & Biorefining-Biofpr. 2011, 5, 250-278.
- (27) Anonymous. Biomass multi year program plan – April 2010. United States Department of Energy:Washington, 2010.
- (28) Spelter, H.; Toth, D. North America's wood pellet sector. Research report FPL–RP–656. Forest Products Laboratory:Madison, 2009.
- (29) Peksa-Blanchard, M.; Dolzan, P.; Grassi, A.; Heinimö, J.; Junginger, M.; Ranta, T.; Walter, A. IEA Bioenergy Task 40 - Global wood pellets markets and industry: policy drivers, market status and raw material potential. International Energy Agency (IEA):Paris, 2007.
- (30) Alakangas, E. In: New European pellets standards; Energiesparverband Oberösterreich: Linz, 2010.
- (31) Alakangas, E.; Paju, P. In: Wood pellets in Finland, technology, economy and market. OPET 5 report. VTT Technical Research Centre of Finland: Espoo, 2002.
- (32) Larsson, S. H. In: Fuel pellet production from reed canary grass - Supply potentials and process technology. PhD thesis, Swedish University of Agricultural Science: Umeå, 2008.

- (33) Panoutsou, C. In: Supply of solid biofuels: Potential feedstocks, cost and sustainability issues in EU27; Grammelis, P., Ed.; Solid Biofuels for Energy; Springer: London, 2011.
- (34) Arshadi, M.; Gref, R.; Geladi, P.; Dahlqvist, S.; Lestander, T. The influence of raw material characteristics on the industrial pelletizing process and pellet quality. *Fuel Processing & Technology*. 2008, 89, 1442-1447.
- (35) Finell, M.; Arshadi, M.; Gref, R.; Scherzer, T.; Knolle, W.; Lestander, T. Laboratory-scale production of biofuel pellets from electron beam treated Scots pine (*Pinus silvestris* L.) sawdust. *Radiation Physics and Chemistry*. 2009, 78, 281-287.
- (36) Filbakk, T.; Skjevraak, G.; Hoibo, O.; Dibdiakova, J.; Jirjis, R. The influence of storage and drying methods for Scots pine raw material on mechanical pellet properties and production parameters. *Fuel Processing & Technology*. 2011, 92, 871-878.
- (37) Holm, J. K.; Henriksen, U. B.; Wand, K.; Hustad, J. E.; Posselt, D. Experimental verification of novel pellet model using a single pelleter unit. *Energy & Fuels*. 2007, 21, 2446-2449.
- (38) Li, Y. D.; Liu, H. High-pressure densification of wood residues to form an upgraded fuel. *Biomass & Bioenergy* 2000, 19, 177-186.
- (39) Nielsen, N. P. K.; Gardner, D. J.; Felby, C. Effect of extractives and storage on the pelletizing process of sawdust. *Fuel* 2010, 89, 94-98.
- (40) Nielsen, N. P. K.; Gardner, D. J.; Poulsen, T.; Felby, C. Importance of temperature, moisture content, and species for the conversion process of wood residues into fuel pellets. *Wood and Fiber Science* 2009, 41, 414-425.
- (41) Nielsen, N. P. K.; Holm, J. K.; Felby, C. Effect of Fiber Orientation on Compression and Frictional Properties of Sawdust Particles in Fuel Pellet Production. *Energy & Fuels*. 2009, 23, 3211-3216.
- (42) Samuelsson, R.; Thyrel, M.; Sjostrom, M.; Lestander, T. A. Effect of biomaterial characteristics on pelletizing properties and biofuel pellet quality. *Fuel Processing & Technology*. 2009, 90, 1129-1134.
- (43) Rhen, C.; Gref, R.; Sjostrom, M.; Wasterlund, I. Effects of raw material moisture content, densification pressure and temperature on some properties of Norway spruce pellets. *Fuel Processing & Technology*. 2005, 87, 11-16.
- (44) Holm, J. K.; Henriksen, U. B.; Hustad, J. E.; Sorensen, L. H. Toward an understanding of controlling parameters in softwood and hardwood pellets production. *Energy & Fuels*. 2006, 20, 2686-2694.
- (45) Biswas, A. K.; Yang, W.; Blasiak, W. Steam pretreatment of *Salix* to upgrade biomass fuel for wood pellet production. *Fuel Processing & Technology*. 2011, 92, 1711-1717.
- (46) Lam, P. S.; Sokhansanj, S.; Bi, X.; Lim, C. J.; Melin, S. Energy input and quality of pellets made from steam-exploded Douglas fir (*Pseudotsuga menziesii*). *Energy & Fuels* 2011, 25, 1521-1528.
- (47) Mani, S.; Tabil, L. G.; Sokhansanj, S. Effects of compressive force, particle size and moisture content on mechanical properties of biomass pellets from grasses. *Biomass & Bioenergy* 2006, 30, 648-654.

- (48) Serrano, C.; Monedero, E.; Lapuerta, M.; Portero, H. Effect of moisture content, particle size and pine addition on quality parameters of barley straw pellets. *Fuel Processing & Technology*. 2011, 92, 699-706.
- (49) Faborode, M. O. Moisture effects in the compaction of fibrous agricultural residues. *Biological Wastes* 1989, 28, 61-71.
- (50) Odogherty, M. J.; Wheeler, J. A. Compression of straw to high-densities in closed cylindrical Dies. *Journal of Agricultural Engineering Research*. 1984, 29, 61-72.
- (51) Adapa, P.; Tabil, L.; Schoenau, G. Compaction characteristics of barley, canola, oat and wheat straw. *Biosystems Engineering*. 2009, 104, 335-344.
- (52) Smith, I. E.; Probert, S. D.; Stokes, R. E.; Hansford, R. J. Briquetting of wheat straw. *Journal of Agricultural Engineering Research*. 1977, 22, 105-111.
- (53) Theerarattananoon, K.; Xu, F.; Wilson, J.; Ballard, R.; Mckinney, L.; Staggenborg, S.; Vadlani, P.; Pei, Z. J.; Wang, D. Physical properties of pellets made from sorghum stalk, corn stover, wheat straw, and big bluestem. *Industrial Crops and Products*. 2011, 33, 325-332.
- (54) Chen, N.; Ren, J.; Zhan, P.; Xu, Z. Effect of process parameters on solid fuel briquette of rice and soybean straw. *Advanced Manufacturing Technology, Pts 1, 2*. 2011, 156-157, 94-97.
- (55) Faborode, M. O.; Ocallaghan, J. R. Optimizing the compression briquetting of fibrous agricultural materials. *Journal of Agricultural Engineering Research*. 1987, 38, 245-262.
- (56) Narra, S.; Tao, Y.; Glaser, C.; Gusovius, H.; Ay, P. Increasing the calorific value of rye straw pellets with biogenous and fossil fuel additives. *Energy & Fuels*. 2010, 24, 5228-5234.
- (57) Kaliyan, N.; Morey, R. V. Densification characteristics of corn stover and switchgrass. *Transactions of the ASABE*. 2009, 52, 907-920.
- (58) Kaliyan, N.; Morey, R. V.; White, M. D.; Doering, A. Roll press briquetting and pelleting of corn stover and switchgrass. *Transactions of the ASABE* 2009, 52, 543-555.
- (59) Kaliyan, N.; Morey, R. V. Natural binders and solid bridge type binding mechanisms in briquettes and pellets made from corn stover and switchgrass. *Bioresource Technology*. 2010, 101, 1082-1090.
- (60) Kaliyan, N.; Morey, R. V. Constitutive model for densification of corn stover and switchgrass. *Biosystems Engineering*. 2009, 104, 47-63.
- (61) Kaliyan, N.; Morey, R. V. Densification characteristics of corn cobs. *Fuel Processing Technology*. 2010, 91, 559-565.
- (62) Gilbert, P.; Ryu, C.; Sharifi, V.; Swithenbank, J. Effect of process parameters on pelletisation of herbaceous crops. *Fuel* 2009, 88, 1491-1497.
- (63) Kaliyan, N.; Morey, R. V. Strategies to improve durability of switchgrass briquettes. *Transactions of the ASABE*. 2009, 52, 1943-1953.
- (64) Kaliyan, N.; Morey, R. V. Densification characteristics of corn stover and switchgrass. ASAE paper No. 06-6174. American Society of Agricultural and Biological Engineers:St. Joseph, 2006.
- (65) Erlich, C.; Ohman, M.; Bjornbom, E.; Fransson, T. H. Thermochemical characteristics of sugar cane bagasse pellets. *Fuel*. 2005, 84, 569-575.

- (66) Coates, W. Using cotton plant residue to produce briquettes. *Biomass & Bioenergy*. 2000, 18, 201-208.
- (67) Choi, Y.; Kim, J.; Cha, D. Comparison of efficiency for wood fuels (chips and pellets) by life cycle assessment. *Journal of Korean Forestry Society*. 2009, 98, 426-434.
- (68) Fasina, O. O. Physical properties of peanut hull pellets. *Bioresource Technology*. 2008, 99, 1259-1266.
- (69) Gil, M. V.; Oulego, P.; Casal, M. D.; Pevida, C.; Pis, J. J.; Rubiera, F. Mechanical durability and combustion characteristics of pellets from biomass blends. *Bioresource Technology*. 2010, 101, 8859-8867.
- (70) Larsson, S. H. Kinematic wall friction properties of reed canary grass powder at high and low normal stresses. *Powder Technology*. 2010, 198, 108-113.
- (71) Carone, M. T.; Pantaleo, A.; Pellerano, A. Influence of process parameters and biomass characteristics on the durability of pellets from the pruning residues of *Olea europaea* L. *Biomass & Bioenergy*. 2011, 35, 402-410.
- (72) Andreiko, D.; Grochowicz, J. Effect of the moisture content on compression energy and strength characteristic of lupine briquettes. *Journal of Food Engineering*. 2007, 83, 116-120.
- (73) Ryu, C.; Finney, K.; Sharifi, V. N.; Swithenbank, J. Pelletised fuel production from coal tailings and spent mushroom compost - Part I - Identification of pelletisation parameters. *Fuel Processing & Technology*. 2008, 89, 269-275.
- (74) Jensen, P. D.; Temmerman, M.; Westborg, S. Internal particle size distribution of biofuel pellets. *Fuel* 2011, 90, 980-986.
- (75) Čolović, R.; Vukmirović, D.; Matulaitis, R.; Bliznikas, S.; Uchockis, V.; Juškienė, V.; Lević, J. Effect of die channel press way length on physical quality of pelleted cattle feed. *Food & Feed Research*. 2010, 1, 1-6.
- (76) Butler, J. L.; McColly, H. F. Factors affecting the pelleting of hay. *Agricultural Engineering*. 1959, 40, 442-446.
- (77) Kaliyan, N.; Morey, R. V. Factors affecting strength and durability of densified biomass products. *Biomass & Bioenergy*. 2009, 33, 337-359.
- (78) Heffner, L. E.; Pfost, H. B. Gelatinization during pelleting. *Feedstuffs*. 1973, 45, 33.
- (79) Briggs, J.; Maier, D.; Watkins, B.; Behnke, K. Effect of ingredients and processing parameters on pellet quality. *Poultry Science*. 1999, 78, 1464-1471.
- (80) Rumpf, H. In: *The strength of granules and agglomeration*; Knepper, W. A., Ed.; Agglomeration; John Wiley: New York, 1962, 379-418.
- (81) Thomas, M.; van Vliet, T.; van der Poel, A. F. B. Physical quality of pelleted animal feed 3. Contribution of feedstuff components. *Animal Feed Science and Technology*. 1998, 70, 59-78.
- (82) Bikerman, J. J. Causes of poor adhesion - weak boundary Layers. *Industrial Engineering Chemistry*. 1967, 59, 40-44.
- (83) Bikerman, J. J. In: *The science of adhesive joints*; Academic Press: New York, 1961.
- (84) Miles, T. R.; Miles, T. R.; Baxter, L. L.; Bryers, R. W.; Jenkins, B. M.; Oden, L. L. Boiler deposits from firing biomass fuels. *Biomass & Bioenergy* 1996, 10, 125-138.
- (85) Pietsch, W. In *Agglomeration processes - phenomena, technologies, equipment*; Wiley-VCH: Weinheim, 2002.

- (86) Thomas, M.; vanZuilichem, D. J.; vanderPoel, A. F. B. Physical quality of pelleted animal feed. 2. Contribution of processes and its conditions. *Animal Feed Science and Technology*. 1997, 64, 173-192.
- (87) Tabil, L. G. In: Binding and pelleting characteristics of alfalfa. PhD thesis, Department of Agricultural and Bioresource Engineering, University of Saskatchewan, Saskatoon:1996.
- (88) Nielsen, N. P. K.; Gardner, D.; Holm, J. K.; Tomani, P.; Felby, C. In The effect of Lignoboost kraft lignin addition on the pelleting properties of pine sawdust; Proceedings from World Bioenergy 2008 Conference and Exhibition Swedish Bioenergy Association: Stockholm, 2008, 98-102.
- (89) Stevens, J.; Gardner, D. J. Enhancing the Fuel Value of Wood Pellets with the Addition of Lignin. *Wood and Fiber Science*. 2010, 42, 439-443.
- (90) Leuenberger, H.; Rohera, D. Fundamentals of powder compression .1. the compactibility and compressibility of pharmaceutical powders. *Pharmaceutical Research*. 1986, 3, 12-22.
- (91) Hiestand, E. N. Principles, tenets and notions of tablet bonding and measurements of strength. *European Journal of Pharmaceutics and Biopharmaceutics*. 1997, 44, 229-242.
- (92) Steward, A. Pelleting of granular materials. *Engineering*. 1950, 169, 203-204.
- (93) Mohsenin, N.; Zaske, J. Stress relaxation and energy-requirements in compaction of unconsolidated materials. *Journal of Agricultural Engineering Research*. 1976, 21, 193-205.
- (94) Mani, S.; Tabil, L. G.; Sokhansanj, S. Evaluation of compaction equations applied to four biomass species. *Canadian Biosystems Engineering* 2004, 46.
- (95) Odogherty, M. J. A Review of the mechanical-behavior of straw when compressed to high-densities. *Journal of Agricultural Engineering Research*. 1989, 44, 241-265.
- (96) Mansouri, H. R.; Pizzi, A.; Leban, J. End-grain butt joints obtained by friction welding of high density eucalyptus wood. *Wood Science and Technology*. 2010, 44, 399-406.
- (97) Delmotte, L.; Mansouri, H. R.; Omrani, P.; Pizzi, A. Influence of wood welding frequency on wood constituents chemical modifications. *Journal of Adhesion Science and Technology*. 2009, 23, 1271-1279.
- (98) Delmotte, L.; Ganne-Chedeville, C.; Leban, J. M.; Pizzi, A.; Pichelin, F. CP-MAS C-13 NMR and FT-IR investigation of the degradation reactions of polymer constituents in wood welding. *Polymer Degradation and Stability*. 2008, 93, 406-412.
- (99) Pizzi, A.; Despres, A.; Mansouri, H.; Leban, J.; Rigolet, S. Wood joints by through-dowel rotation welding: microstructure, C-13-NMR and water resistance. *Journal of Adhesion Science and Technology*. 2006, 20, 427-436.
- (100) Gfeller, B.; Zanetti, M.; Properzi, M.; Pizzi, A.; Pichelin, F.; Lehmann, M.; Delmotte, L. Wood bonding by vibrational welding. *Journal of Adhesion Science and Technology*. 2003, 17, 1573-1589.
- (101) Ganne-Chedeville, C.; Properzi, M.; Leban, J. -.; Pizzi, A.; Pichelin, F. Wood welding: Chemical and physical changes according to the welding time. *Journal of Adhesion Science and Technology*. 2008, 22, 761-773.

- (102) Bouajila, J.; Dole, P.; Joly, C.; Limare, A. Some laws of a lignin plasticization. *Journal of Applied Polymer Science*. 2006, 102, 1445-1451.
- (103) Salmen, L.; Olsson, A. M. Interaction between hemicelluloses, lignin and cellulose: Structure-property relationships. *Journal of Pulp and Paper Science*. 1998, 24, 99-103.
- (104) Olsson, A. M.; Salmen, L. In: *Viscoelasticity of in situ lignin as affected by structure: softwood vs. hardwood*; Glasser, W., Ed.; *Viscoelasticity of biomaterials*; American Chemical Society: Washington, 1992; pp 133-143.
- (105) Back, E. L. The bonding mechanism in hardboard manufacture - Review report. *Holzforschung* 1987, 41, 247-258.
- (106) Bouajila, J.; Limare, A.; Joly, C.; Dole, P. Lignin plasticization to improve binderless fiberboard mechanical properties. *Polymer Engineering & Science*. 2005, 45, 809-816.
- (107) Kleinschmidt, C. P. Overview of international developments in torrefaction. IEA Bioenergy Task 32 and Task 40 workshop, 28. January 2011, Graz, Austria 2011.
- (108) Pimchuai, A.; Dutta, A.; Basu, P. Torrefaction of agriculture residue to enhance combustible properties. *Energy & Fuels* 2010, 24, 4638-4645.
- (109) Deng, J.; Wang, G.; Kuang, J.; Zhang, Y.; Luo, Y. Pretreatment of agricultural residues for co-gasification via torrefaction. *Journal of Analytical and Applied Pyrolysis*. 2009, 86, 331-337.
- (110) Arias, B.; Pevida, C.; Feroso, J.; Plaza, M. G.; Rubiera, F.; Pis, J. J. Influence of torrefaction on the grindability and reactivity of woody biomass. *Fuel Processing and Technology*. 2008, 89, 169-175.
- (111) Kiel, J. H. A.; Verhoeff, F.; Gerhauser, H.; Meuleman, B. Torrefaction-based BO(2)-technology for biomass upgrading into commodity solid fuel Pilot-scale testing and demonstration. *Strom und Wärme aus Biogenen Festbrennstoffen*. 2008, 2044, 43-51.
- (112) Prins, M. J.; Ptasinski, K. J.; Janssen, F. J. J. G. Torrefaction of wood - Part 1. Weight loss kinetics. *Journal of Analytical and Applied Pyrolysis*. 2006, 77, 28-34.
- (113) Prins, M. J.; Ptasinski, K. J.; Janssen, F. J. J. G. Torrefaction of wood - Part 2. Analysis of products. *Journal of Analytical and Applied Pyrolysis*. 2006, 77, 35-40.
- (114) Prins, M. J.; Ptasinski, K. J.; Janssen, F. J. J. G. More efficient biomass gasification via torrefaction. *Energy* 2006, 31, 3458-3470.
- (115) Pentananunt, R.; Rahman, A. N. M. M.; Bhattacharya, S. C. Upgrading of biomass by means of torrefaction. *Energy* 1990, 15, 1175-1179.
- (116) Yan, W.; Acharjee, T. C.; Coronella, C. J.; Vasquez, V. R. Thermal pretreatment of lignocellulosic biomass. *Environmental Progress & Sustainable Energy* 2009, 28, 435-440.
- (117) Acharjee, T. C.; Coronella, C. J.; Vasquez, V. R. Effect of thermal pretreatment on equilibrium moisture content of lignocellulosic biomass. *Bioresource Technology*. 2011, 102, 4849-4854.
- (118) Brosse, N.; El Hage, R.; Chaouch, M.; Petrissans, M.; Dumarcay, S.; Gerardin, P. Investigation of the chemical modifications of beech wood lignin during heat treatment. *Polymer Degradation and Stability*. 2010, 95, 1721-1726.
- (119) Repellin, V.; Govin, A.; Rolland, M.; Guyonnet, R. Energy requirement for fine grinding of torrefied wood. *Biomass & Bioenergy* 2010, 34, 923-930.

- (120) Bourgois, J.; Bartholin, M. C.; Guyonnet, R. Thermal-treatment of wood - analysis of the obtained product. *Wood Science and Technology*. 1989, 23, 303-310.
- (121) Melkior, T.; Jacob, S.; Gerbaud, G.; Hediger, S.; Le Pape, L.; Bonnefois, L.; Bardet, M. NMR analysis of the transformation of wood constituents by torrefaction. *Fuel* 2011, doi:10.1016/j.fuel.2011.06.042.
- (122) Rousset, P.; Lapierre, C.; Pollet, B.; Quirino, W.; Perre, P. Effect of severe thermal treatment on spruce and beech wood lignins. *Annals of Forest Science*. 2009, 66.
- (123) Bergman, P. C. A. In: Combined torrefaction and pelletization: the TOP process. ECN Report: ECN-C-05-073, Energy Centre of The Netherlands (ECN): Petten,2005.
- (124) Henriksen, U. B.; Holm, J. K.; Simonsen, P.; Berg, M.; Posselt, D.; Nikolaisen, L.; Plackett, D.; Møller, J. D. Fundamental understanding of pelletization. Summary report: EFP-2005 project (33031-037). Technical University of Denmark:Lyngby,2008.

Appendix (Papers I – VII)

Here the reader will find the individual papers upon which this PhD study is based.

Due to copyright restrictions the public version of this thesis does not contain the original research articles. They can be obtained from your local university library or purchased from the journal publisher.

- I. Stelte W, Holm JK, Sanadi AR, Barsberg S, Ahrenfeldt J, Henriksen UB. Fuel pellets from biomass: the importance of the pelletizing pressure and its dependency on the processing conditions. *Fuel*, 2011, 90(11):3285-3290.
- II. Holm JK, Stelte W, Posselt D, Ahrenfeldt J, Henriksen UB. Optimization of a multi-parameter model for biomass pelletization to investigate temperature dependence and to facilitate fast testing of pelletization behavior. *Energy and Fuels*, 2011,25(8):3706-3711.
- III. Stelte W, Holm JK, Sanadi AR, Barsberg S, Ahrenfeldt J, Henriksen UB. A study of bonding and failure mechanisms in fuel pellets from different biomass resources. *Biomass and Bioenergy*, 2011, 35(2):910-918.
- IV. Stelte W, Clemons C, Holm JK, Ahrenfeldt J, Henriksen UB, Sanadi AR. Thermal transition of the amorphous polymers in wheat straw. *Industrial Crops and Products*, 2011, 34(1):1053-1056.
- V. Stelte W, Clemons C, Holm JK, Sanadi AR, Ahrenfeldt J, Henriksen UB. The effect of lignin glass transition and surface waxes on the pelletizing properties of wheat straw. *Bioenergy Research*, DOI 10.1007/s12155-011-9169-8, Article in Press
- VI. Stelte W*, Clemons C, Holm JK, Sanadi AR, Shang, L, Ahrenfeldt J, Henriksen UB, Fuel pellets from torrefied spruce. *Biomass and Bioenergy*,2011, 35(11):4690-4698.
- VII. Stelte W, Shang L, Nielsen NPK, Sanadi AR. Pelletizing properties of torrefied wheat straw. Accepted for presentation at World Sustainable Energy Days, European Pellets Conference, Wels, Austria, 2012.

The following pages have been deleted from the public version of this thesis due to copyright restrictions!

In case of questions please contact the author of this thesis

Wolfgang Stelte: stelte@gmail.com

Risø DTU is the National Laboratory for Sustainable Energy. Our research focuses on development of energy technologies and systems with minimal effect on climate, and contributes to innovation, education and policy. Risø has large experimental facilities and interdisciplinary research environments, and includes the national centre for nuclear technologies.

Risø DTU
National Laboratory for Sustainable Energy
Technical University of Denmark

Frederiksborgvej 399
PO Box 49
DK-4000 Roskilde
Denmark
Phone +45 4677 4677
Fax +45 4677 5688

www.risoe.dtu.dk