



OTN Transport of Baseband Radio Serial Protocols in C-RAN Architecture for Mobile Network Applications

Checko, Aleksandra; Kardaras, Georgios; Lanzani, Christian Fabio Alessandro; Temple, Dan; Mathiasen, Carsten; Pedersen, Lars A.; Klaps, Bert

Publication date:
2014

Document Version
Publisher's PDF, also known as Version of record

[Link back to DTU Orbit](#)

Citation (APA):
Checko, A., Kardaras, G., Lanzani, C. F. A., Temple, D., Mathiasen, C., Pedersen, L. A., & Klaps, B. (2014). *OTN Transport of Baseband Radio Serial Protocols in C-RAN Architecture for Mobile Network Applications*. Altera. <http://www.altera.com/literature/wp/wp-01215-cpri-obsai-otn.pdf>

General rights

Copyright and moral rights for the publications made accessible in the public portal are retained by the authors and/or other copyright owners and it is a condition of accessing publications that users recognise and abide by the legal requirements associated with these rights.

- Users may download and print one copy of any publication from the public portal for the purpose of private study or research.
- You may not further distribute the material or use it for any profit-making activity or commercial gain
- You may freely distribute the URL identifying the publication in the public portal

If you believe that this document breaches copyright please contact us providing details, and we will remove access to the work immediately and investigate your claim.

OTN Transport of Baseband Radio Serial Protocols in C-RAN Architecture for Mobile Network Applications

Abstract

This white paper presents a proof of concept implementation of digital baseband radio data transport over Optical Transport Network (OTN) compliant to 3GPP Long Term Evolution – Advanced (LTE-A) standard enabling Cloud Radio Access Network (C-RAN) architecture. The transport between the baseband module and a remote radio module is compliant to Common Public Radio Interface (CPRI) and to the OBSAI reference point 3 - 01 (RP3-01) interface protocols, respectively. The purpose is to demonstrate that data integrity and clocking performance at the radio node still meets the strict standard requirements after CPRI and OBSAI transport over an OTN.

Introduction

To support increasing demand for mobile data traffic, mobile network operators need to implement new solutions, which will maintain Total Cost of Ownership (TCO) at a reasonable level. Otherwise, the growing cost of supporting more bandwidth may exceed the operator’s revenues.

Figure 1. Network Costs Exceed Revenue

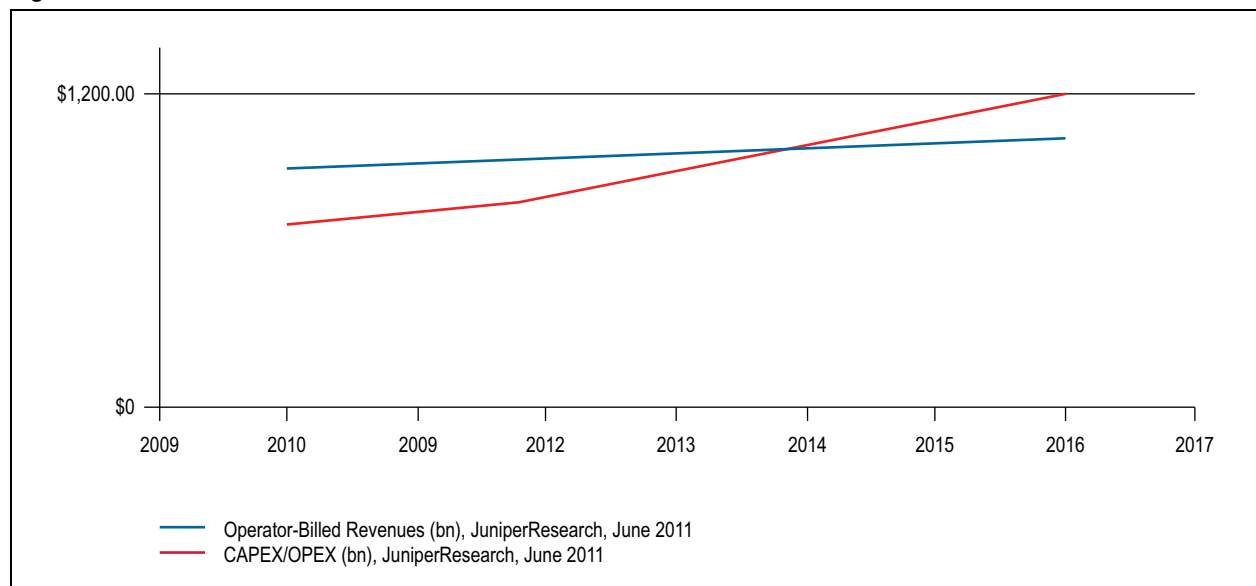

Features and Benefits of C-RAN

C-RAN is a novel mobile network architecture that has the potential to lower the network cost and energy consumption. ⁽¹⁾ In C-RAN the remote radio head (RRH) modules are connected to the virtualized baseband unit (BBU) pool, thereby sharing the baseband processing resources among the traffic loads. Fewer BBUs are needed in the pool in C-RAN than in traditional architecture. ⁽²⁾ ⁽³⁾ ⁽⁴⁾ In C-RAN when users move throughout the day between office and residential areas, they can still be served by the same baseband resources in the pool. In traditional RAN, the assignment of RRH to BBU is static, therefore the resources needed to be present in both office and residential areas, being underutilized in periods of lower activity, for example, evenings for office areas. The need for fewer BBUs reduces capital expenditure (CAPEX) in terms of lower equipment cost and operating expenditure (OPEX), as fewer BBUs consume less energy and allows much more efficient maintenance, by reducing costly truck-rolls. ZTE estimates that C-RAN enables 67% - 80% power savings compared with traditional RAN architecture, depending on how many cells one BBU pool covers, ⁽⁵⁾ which stays in line with China Mobile research claiming 71% power savings. ⁽⁶⁾ Further energy savings can be achieved by switching off some BBUs in the BBU pool in lower activity period, still maintaining the full network coverage. However, the cost of leasing fiber connections necessary to connect RRHs to BBU pool needs to be evaluated to perform final cost-benefit analysis of C-RAN.

Such C-RAN enables higher throughput in a mobile network boosting inter-cell interference coordination (ICIC) and coordinated multipoint (CoMP) transmission schemes. This is especially important, as more new cells are being added to increase mobile network capacity and interference management needs to be efficiently realized to achieve the capacity increase. When all the cells within a CoMP set are served by one BBU pool, then a single entity doing signal processing enables tighter cooperation between base stations. Therefore interference can be kept to lower level and consequently the throughput can be increased. ⁽⁷⁾ Moreover, implementing ICIC over a central unit - BBU Pool - enables optimization of transmission from many cells to multiple BBUs. ⁽⁸⁾ It has been proven that combining clustering of cells with CoMP makes more efficient use of the radio bandwidth. ⁽⁹⁾

In the paper *C-RAN The Road Towards Green RAN* ⁽¹⁾, authors present simulation results that compare spectrum efficiency of joint transmission (JT), the most advanced CoMP scheme, in C-RAN to non-cooperative transmission. Up to 20% increase in spectrum efficiency was observed. For a cell edge user, spectrum efficiency can increase by up to 119%. In the paper *Field Test of Uplink CoMP Joint Processing with C-RAN Testbed* ⁽¹⁰⁾, LTE UL CoMP joint processing has been verified on a C-RAN test bed around Ericsson offices in Beijing. Significant gain was achieved at the cell edge both for intra-site CoMP and inter-site CoMP. Throughput gain is 30% - 50% when there is no interference and can reach 150% when interference is present.

C-RAN enables:

- CAPEX, OPEX reduction for mobile operators
- Enhanced scalability of a mobile network, as new cells can be easily deployed plugging RRH to BBU pool
- Easier implementation of joint processing and scheduling to mitigate inter-cell interference thereby enhancing spectral efficiency
- Adaptability to non-uniform traffic

- Enhanced BBU failover mechanisms

Mapping of CPRI and OBSAI over OTN

CPRI and OBSAI are common protocols used to carry baseband data between RRH and BBU pool. In C-RAN, typically RRHs from one metropolitan area will be connected to a BBU pool to achieve statistical multiplexing gain between cells from office, residential and commercial areas. In the presence of OTN distances up to 40 km may be covered by mapping the CPRI/OBSAI bit streams to OTN.

OTN can be found in many fiber network deployments and can be reused to enable C-RANs. Mapping of CPRI/OBSAI bit streams over OTN is done over low-level optical channel data unit (ODU) containers as specified in ITU-T G.709/Y.1331. The main challenges of transmitting CPRI/OBSAI over OTN is to limit the frequency error introduced while mapping and de-mapping CPRI/OBSAI to OTN. Moreover, the signal must not be deteriorated to maintain its characteristics. Deterministic awareness of the delays through each hop needs to be maintained.

OTN provides:

- A standard way of supervising client's signals, assure reliability as well as achieve carrier grade of service
- A promising solution for optical transport network of C-RAN when existing OTN legacy network can be reused for C-RAN fronthaul connecting RRHs to BBU pool
- Forward error correction (FEC) allowing the transport of client signals like CPRI in noisy environments or over longer distances
- Support for both wavelength- and time-domain multiplexing maximizing the bandwidth utilization of the fiber network

We experimented by connecting a base station emulator (BSE) and a RRH provided from MTI Radiocomp to an OTN-compliant client-to-OTU2 Mapper and Multiplexer from Altera using both CPRI and OBSAI bit streams at different rates carrying LTE traffic. We measured and observed that carrier frequency error and error vector magnitude (EVM) changes are within 3GPP specifications for LTE-Advanced.

OTN Solution

When the customer or mobile network operator owns little fiber or when the cost of leasing fiber is high in both first and second mile, the C-RAN architecture presented in [Figure 2](#) is beneficial. The BBU pool is located on OTN ring. CPRI/OBSAI is carried between the BBU pool and RRH over OTN. CPRI/OBSAI can be mapped to OTN containers using the OTN mapper from Altera.

Figure 2. C-RAN Architecture for Scarce Fiber in First and Second Miles

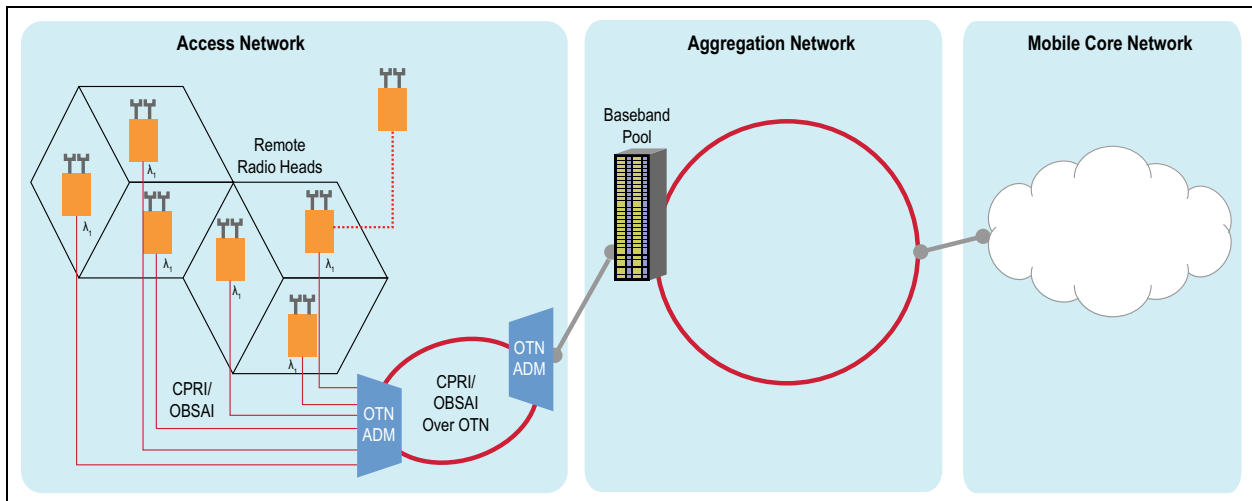

We benchmarked the CPRI/OBSAI over OTN transport performance against a reference setup shown in Figure 3. The BSE sends IQ data over CPRI protocol to the RRH. A signal analyzer is used to measure EVM and frequency error of the transmitted signal from the RRH antenna port.

Figure 3. Reference Setup for CPRI over OTN Testing

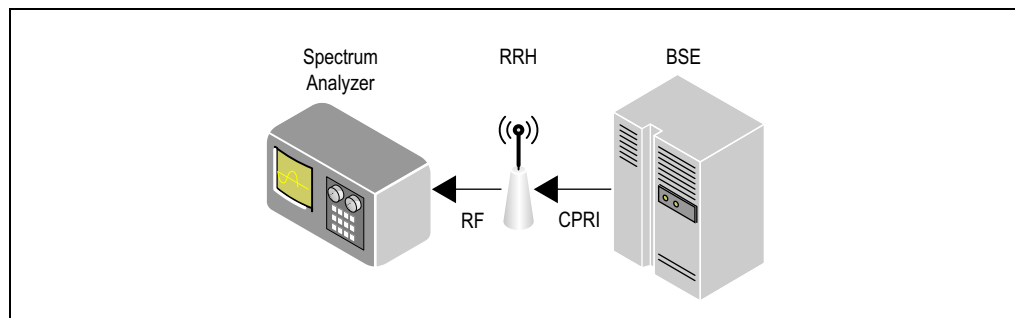

Figure 4 and Figure 5 show the actual measurement setup. We introduced the Altera® TPO124/125 OTN multiplexer that maps CPRI client signals to the OTN containers and back from the OTN containers to CPRI. We measured the data EVM and frequency error, and compared the results to the one achieved with the setup presented in Figure 3.

Figure 4. CPRI over OTN Mapping—Point-to-Point Measurement Setup

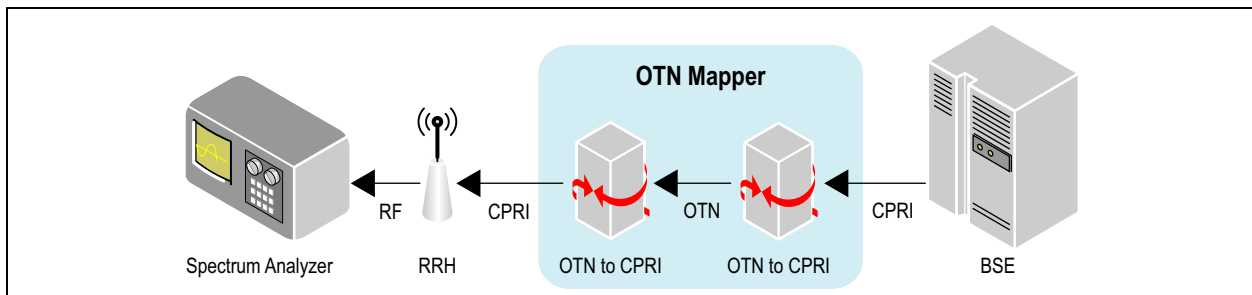

Figure 5. CPRI over OTN Mapping— 3-Node Ring Measurement Setup

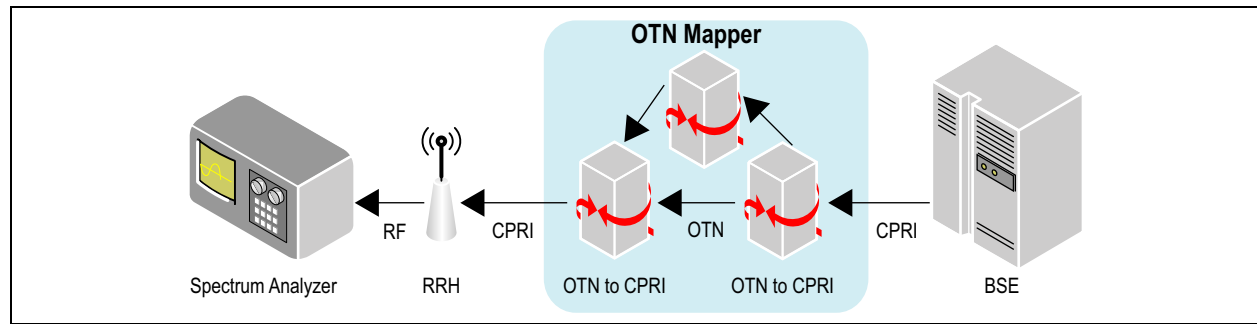

Figure 6 shows a detailed overview of the system.

Figure 6. Detailed Measurement Setup

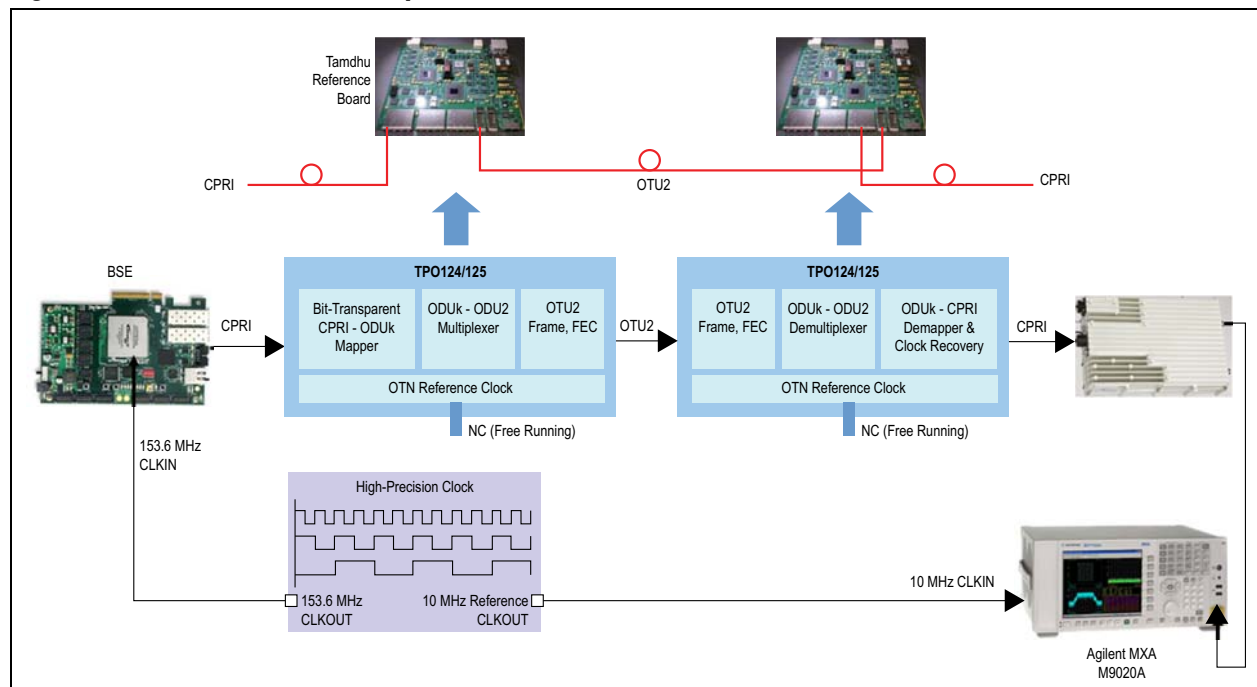

Table 1 lists four separate sets of measurements that were conducted, focusing on CPRI and OBSAI, using TPO124 and TPO125 mappers.

Table 1. Measurement Scenarios

Client	OTN Mapper	TP0124	TP0125
CPRI-3 2.4576 Gbps, point-to-point		Scenario 1	Scenario 2
OBSAI 3.072 Gbps, point-to-point		Scenario 3	Scenario 4
OBSAI 3.072 Gbps, 3-node ring		N/A	Scenario 5

Table 2 lists the parameters used in the setup.

Table 2. Setup Specifications

Base Station	Base Station Emulator	
	External clock	153.6 MHz
Optical transport	Fiber	Multimode
	SFP	Multimode, 850 nm, Finisar FTLF8524P2xNy
OTN	TPO124	Talisker Reference board with TPO124 client-to-OTU2 mapper
	TPO125	Tamdhu Reference board with TPO125 client-to-OTU2 mapper
	Optical fiber loopback on OTU2 port	
RRH for CPRI	model	RRH 700 MHz, FDD, 2x67 W
	Carrier center frequency	737 MHz
RRH for OBSAI	Model	RRH 850 MHz, FDD, 2x40 W
	Carrier center frequency	880 MHz
Client: CPRI-3 2.4576 Gbps	Mapping	GMP/ODU1
	Multiplexing	AMP ODU1/ODU2
	Line	OTU2
Client: OBSAI 3.072G	Mapping	BMP/ODUflex (as per CPRI-4)
	Multiplexing	GMP ODUflex/ODU2
	Line	OTU2
Test signals (3GPP 36.141)	LTE, 10 MHz, 10 ms	
	QPSK	ETM 3.3
	16 QAM	ETM 3.2
	64 QAM	ETM 3.1

Results for Transmission of CPRI and OBSAI over OTN

Table 3 summarizes the results for transmission of CPRI and OBSAI protocols for three different modulations—QPSK, 16 QAM, and 64 QAM measurements were taken without OTN (Figure 3), with TPO124 and TPO125 as OTN mappers (Figure 4), and as a 3-node ring (Figure 5). The maximum EVM and frequency error for each modulation, in each scenario is observed.

Looking at the performance of transmission of CPRI over OTN, we can see that OTN transmission caused negligible EVM degradation compared to its reference scenario. The frequency error increased; however, it stays within the requirements. Similar conclusions were drawn for the performance of OBSAI over OTN transmission when compared to its reference scenario—negligible EVM increase while the frequency error stayed within the requirements.

Table 3 lists the worst case observations over a 1-minute interval.

Table 3. Measurement Results Summary for Point-to-Point Configuration

Modulation	OTN Device	CPRI		OBSAI		Requirement	
		EVM (%)	Frequency Error (ppm)	EVM (%)	Frequency Error (ppm)	EVM (%) 3GPP 36.104	Frequency Error (ppm)
QPSK	–	5.5	0.003	9.9	0.005	<17.5%	<0.05 ppm (3GPP 36.104)
	TPO124	5.7	0.026	9.9	0.034		
	TPO125	5.7	0.015	–	–		
16 QAM	–	5.5	0.003	6.9	0.007	<12.5%	
	TPO124	5.6	0.023	7.2	0.028		
	TPO125	5.6	0.016	–	–		
64 QAM	–	5.5	0.003	4.4	0.005	<8%	
	TPO124	5.7	0.027	5.1	0.028		
	TPO125	5.7	0.018	4.5	0.034		

Figure 7 shows an example of results for 64QAM modulated signal transmitted with OBSAI protocol over OTN with TPO125 device. The upper left figure shows the modulation constellation. In the upper right figure, the frequency error is displayed for each of the 20 slots of a 10 ms LTE frame. The lower right figure shows the summary of measurements with EVM and averaged frequency error. Similar results can be expected with CPRI-4.

Figure 7. Results 64QAM with OBSAI Using TPO125 Device

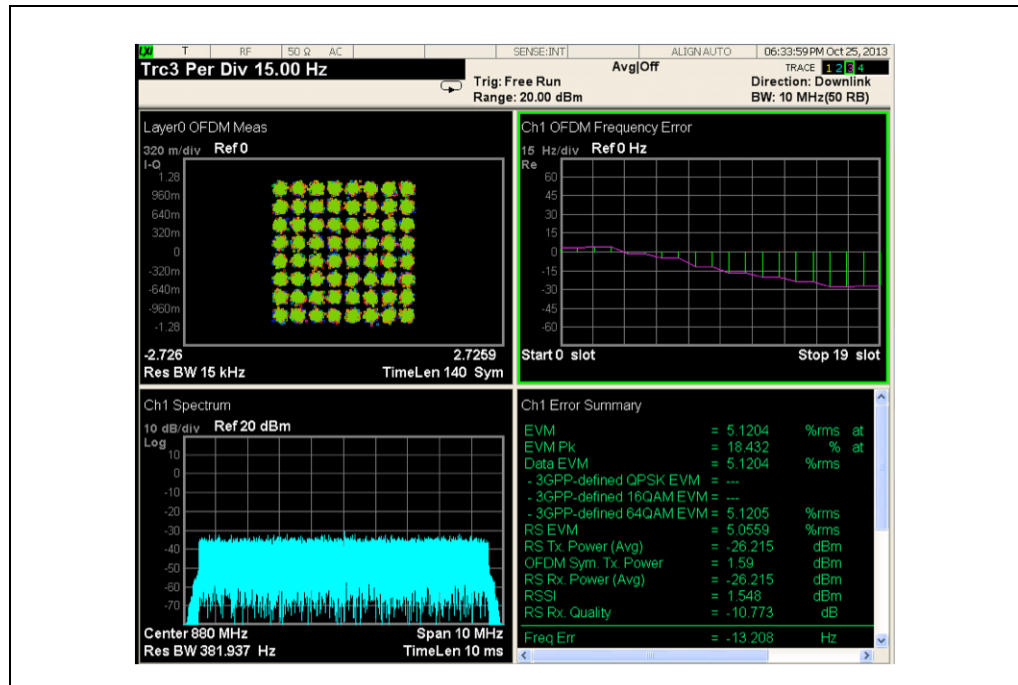

Table 4 lists the results of the measurements in Scenario 5, the 3-node ring configuration.

Table 4. Measurement Results Summary for 3-Node Ring Configuration

Modulation	OTN Device	CPRI		OBSAI		Requirement	
		EVM (%)	Frequency Error (ppm)	EVM (%)	Frequency Error (ppm)	EVM (%) 3GPP 36.104	Frequency Error (ppm)
64 QAM	TP0125	N/A	N/A	5.1	0.034	<8%	<0.05 ppm

Conclusion

C-RAN is a promising network architecture offering CAPEX and OPEX savings and improved network performance. OTN is a recommended optical transport solution for IQ transport between RRH and BBU pool when mobile network operator has a cost-efficient access to legacy OTN network, which can be reused for C-RAN.

We present a proof of concept of transmitting radio interface protocols over OTN enabling to exploit the benefits of C-RAN. Our solution introduces negligible EVM increase and small frequency error. It is fully compliant with 3GPP requirements for LTE-Advanced. Future work includes integration of setup with higher CPRI/OBSAI bit rates up to 10 Gbps and verification of deterministic delay measurements.

References

1. "C-RAN The Road Towards Green RAN," China Mobile Research Institute, Tech. Rep., October 2011.
2. S. Namba, T. Matsunaka, T. Warabino, S. Kaneko, and Y. Kishi, "Colony-RAN architecture for future cellular network," in Future Network Mobile Summit (FutureNetw), 2012, July 2012, pp. 1–8.
3. M. Madhavan, P. Gupta, and M. Chetlur, "Quantifying multiplexing gains in a wireless network cloud," in Communications (ICC), 2012 IEEE International Conference on, 2012, pp. 3212–3216.
4. A. Checko, H. Christiansen, and M. S. Berger, "Evaluation of energy and cost savings in mobile Cloud-RAN," in Proceedings of OPNETWORK Conference, 2013.
5. "ZTE Green Technology Innovations White Paper," ZTE, Tech. Rep., 2011.
6. C. Chen, "C-RAN: the Road Towards Green Radio Access Network. Presentation," August 2012.
7. H. Jinling, "TD-SCDMA/TD-LTE evolution - Go Green," in Communication Systems (ICCS), 2010 IEEE International Conference on, 2010, pp. 301–305.
8. H. Holma and A. Toskala, "LTE-Advanced: 3GPP Solution for IMTAdvanced". John Wiley and Sons, Ltd, 2012.
9. R. Irmer, H. Droste, P. Marsch, M. Grieger, G. Fettweis, S. Brueck, H. P. Mayer, L. Thiele, and V. Jungnickel, "Coordinated multipoint: Concepts, performance, and field trial results," Communications Magazine, IEEE, vol. 49, no. 2, pp. 102–111, 2011.

10. L. Li, J. Liu, K. Xiong, and P. Butovitsch, "Field test of uplink CoMP joint processing with C-RAN testbed," in Communications and Networking in China (CHINACOM), 2012 7th International ICST Conference on, 2012, pp. 753–757.

About MTI Mobile

Microelectronics Technology Inc. (MTI)—headquartered in Taiwan—is a leading global provider of products and solutions for the wireless telecommunications industry. MTI’s Mobile division focus is on design and manufacturing of state-of-the-art radio and interfacing technology components for use in 4G mobile networks and beyond. MTI develops its technology in Taiwan, the USA and in Denmark while owning and operating manufacturing facilities in Taiwan and China.



For more information about MTI, visit the website www.mtigroup.com.

About Altera

Altera programmable solutions enable designers of electronic systems to rapidly and cost effectively innovate, differentiate, and win in their markets. Altera offers FPGAs, SoCs, CPLDs, and complementary technologies, such as power management, to provide high-value solutions to customers worldwide.



For more information about Altera, visit the website www.altera.com.

Authors

- Aleksandra Checko, Industrial PhD Student, MTI Mobile
- Georgios Kardaras, Ph.D, Engineering Manager, MTI Mobile
- Christian Lanzani, Ph.D., Head of Product & IP Management, MTI Mobile
- Dan Temple, Senior Manager FPGA Design, Altera Corporation
- Carsten Mathiasen, Senior Design Engineer, Altera Corporation
- Lars A. Pedersen, Wireline Strategic Marketing, Altera Corporation
- Bert Klaps, Senior System Engineer, Altera Corporation

Document Revision History

Table 5 lists the revision history for this document.

Table 5. Document Revision History

Date	Version	Changes
March 2014	1.0	Initial release.