



Coordinated system services from offshore wind power plants connected through HVDC networks

Zeni, Lorenzo; Glasdam, Jakob; Hesselbæk, Bo; Lund, T.; Sørensen, Poul Ejnar; Hansen, Anca Daniela; Kjær, Philip C.

Published in:
CIGRE Session 45, 2014

Publication date:
2014

[Link back to DTU Orbit](#)

Citation (APA):

Zeni, L., Glasdam, J., Hesselbæk, B., Lund, T., Sørensen, P. E., Hansen, A. D., & Kjær, P. C. (2014). Coordinated system services from offshore wind power plants connected through HVDC networks. In *CIGRE Session 45, 2014* [C1-PS2 – C1_212_2014 NCA 535] International Council on Large Electric Systems.

General rights

Copyright and moral rights for the publications made accessible in the public portal are retained by the authors and/or other copyright owners and it is a condition of accessing publications that users recognise and abide by the legal requirements associated with these rights.

- Users may download and print one copy of any publication from the public portal for the purpose of private study or research.
- You may not further distribute the material or use it for any profit-making activity or commercial gain
- You may freely distribute the URL identifying the publication in the public portal

If you believe that this document breaches copyright please contact us providing details, and we will remove access to the work immediately and investigate your claim.



Coordinated system services from offshore wind power plants connected through HVDC networks

**L. ZENI*, J. GLASDAM,
B. HESSELBÆK
DONG Energy
Denmark**

**T. LUND
Energinet.dk
Denmark**

**P.E. SØRENSEN,
A.D. HANSEN
Technical University of
Denmark**

**P.C. KJÆR
Aalborg
University
Denmark**

SUMMARY

This paper presents an overview of power system services in networks involving multiple onshore power systems, a voltage sourced converter (VSC) based high voltage direct current (HVDC) offshore network and an offshore wind power plant (OWPP). A comprehensive list of services regarding onshore as well as offshore network operation – both AC and DC – will be discussed from a state of the art perspective. Among them, the most interesting have been selected and will be treated in more detail and the main contribution of this paper will be to shed light on the most relevant aspects related to their implementation. For example, new findings on onshore AC voltage control are reported, that help the characterisation of potential AC voltage control that a VSC-HVDC station may offer to an onshore AC grid. The HVDC system behind the VSC-HVDC station may connect, through other converters, to another AC power system, or an OWPP, or both. Moreover, the implementation of power oscillation damping (POD) and HVDC voltage control into an OWPP controller is proposed, discussing the main challenges related to their efficient design. Dynamic control challenges are assessed, in particular in relation to the inherent control and communication delays of OWPPs, and their influence on the successful delivery of the targeted services. Furthermore, it is shown that as an HVDC network increases in size from the point-to-point, the handling of onshore short circuits calls for the proper combination of DC chopper(s) and fast DC voltage control, depending on the specific case. All the treated services are crucial from a transmission operator's (TSO) perspective, to guarantee stability, security of supply and efficiency. For this reason, the paper proposes a qualitative benchmarking of the HVDC station and, when relevant, its combination with OWPPs, against a conventional power station of comparable size. Consequently it will be pointed out what features will be critical for TSOs when partially or completely replacing conventional units with HVDC stations connected to neighbouring systems and/or OWPPs.

KEYWORDS

DC chopper, DC voltage control, Frequency control, High Voltage Direct Current (HVDC), Power oscillation damping, System services, Voltage control, Wind power

1. INTRODUCTION

As offshore wind power plants (OWPPs) are installed ever further away from shore, high voltage direct current (HVDC) transmission becomes the technically most viable solution for their connection to land. Voltage source converter (VSC) HVDC systems are already being installed in the German North Sea and the same technology is looked at with increasing interest in relation to future projects in the United Kingdom (UK) as well [1]. Additionally, new offshore installations of HVDC interconnectors between Northern European countries are continuously conceived and deployed. Suggestions have been raised for a full integration of HVDC interties and HVDC connected OWPPs into a unique so-called North Sea super-grid, in order to achieve a more optimal economic performance. Going even further, a pan-European HVDC grid concept has also been looked at [2],[3]. The utilisation of a rather immature technology poses some challenges to wind turbine manufacturers, HVDC system suppliers, OWPP developers and transmission system operators (TSOs), that must harmoniously ensure all the electrical elements can be integrated and be grid code compliant. Traditionally, a major part of the power production has been delivered by conventional power plants with large synchronous machines and hydro or thermal prime movers. These power plants deliver a variety of system services such as short circuit power, reactive power and voltage control, inertia, power oscillation damping (POD), primary and secondary frequency control, reserve power and black start capability [4]. The installation of a large amount of offshore wind power will lead to crowding out of a large part of the thermal production units with higher marginal production costs than the OWPPs. Either the new (HVDC connected) OWPPs must be able to deliver the same services as the conventional units that they replace, or additional dedicated units such as for example synchronous condensers or static compensators (STATCOMs) must be installed to make up for them. This increases costs, system complexity and substation land take. Furthermore, new services may be required by HVDC systems, especially in case they expand beyond two terminals [5].

On the one hand, the high controllability of modern power electronic devices (PEDs) offers a solid base to rely upon when providing the above mentioned services. On the other hand, one must deal with control coordination and communication issues due to the many interacting elements – e.g. HVDC converters, OWPPs, onshore AC system controls, etc. – and their different dynamic performance. Moreover, the uncontrollable nature of wind power poses further challenges to be handled. This paper takes inspiration from this scenario, where OWPPs are connected to onshore AC systems via HVDC networks, and deals with the provision of system services through proper coordination of HVDC converters and OWPPs.

2. SIMULATION SETUP

As a first, incremental, step from the usual point-to-point HVDC connection of OWPPs, a three-terminal network is taken as reference case. An OWPP is connected in parallel to a VSC-HVDC link connecting two asynchronous power systems. The simplified electrical diagram is shown in Figure 1.

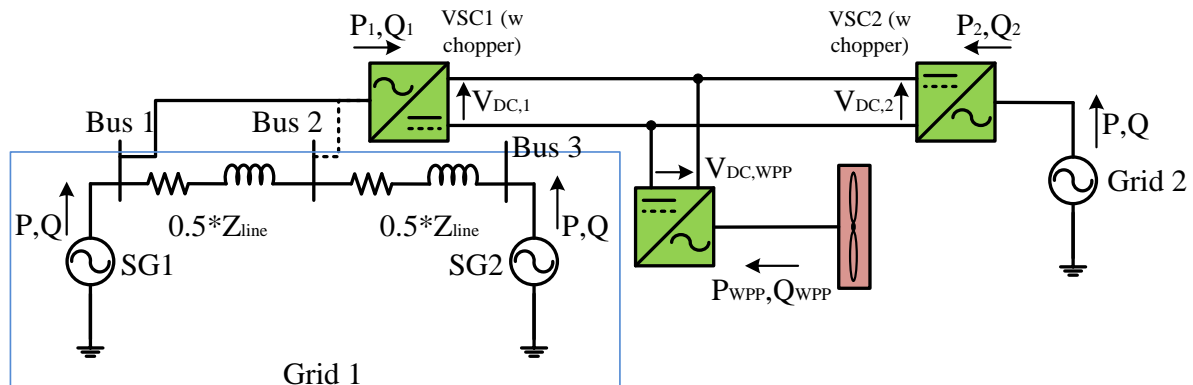

Figure 1 - Simplified simulation setup diagram.

Such a network is deemed to be able to capture all the most important aspects of the relevant system services, which will be treated in the following sections as follows:

- AC voltage control, both onshore and offshore.
- Onshore frequency control (FC).

- POD in onshore grid.
- DC voltage control.
- Handling of short circuits in the onshore and offshore AC systems and in the DC grid.

Emphasis in this paper is laid mainly on onshore AC voltage control, POD, DC voltage control and onshore AC faults. Simulation results are reported to support the discussion and prove the concepts. The remaining services are left to future publications, but a summary of the state of the art is included. Suitable generic models are used for the electrical components and OWPP and user defined generic controllers are employed in the simulation model. The VSCs are all rated equally and the OWPP's nominal active power corresponding to 0.83 pu of the VSCs' rating. The detailed description of the simulation model is out of the scope of this paper and was partly published in previous work [6]. However, features that are deemed to be relevant to illustrate the content of the present paper are reported in the next sections.

After discussing the above system services in Sections 3 to 7 a qualitative benchmarking with a conventional unit is proposed in Section 8. The HVDC converter – and its combination with an OWPP – will be compared with a conventional power plant of similar size, addressing the performance with regard to the considered system services. This will point out the most critical factors TSOs will have to focus on when replacing conventional generation with HVDC stations connected to OWPPs.

3. AC VOLTAGE CONTROL AND SHORT CIRCUIT POWER

Offshore AC voltage control

The control of the voltage in the offshore AC network is a vast topic that is generically a sub-aspect of the overall control philosophy of the offshore inertia-less network. Standard solutions where the HVDC converter plays the role of the master and the OWPP synchronises in the usual way are traditionally employed in research projects [7],[8]. However, more generalised paradigms where every converter actively participates in the control have also been proposed [9]. Moreover, other control techniques may also be applied to handle the control problem [10]. In the authors' experience, the offshore grid control must be carefully designed both for no-load operation, where grid resonances must be properly damped, and under load, where possible low frequency instabilities may arise. In particular, when the master converter is operating against converters of similar size, the control philosophy and parameters have a significant influence on the proper operation of the network.

Onshore AC voltage control and short circuit power

The onshore AC voltage control of HV networks is usually strongly cross-coupled with the control of the reactive power and the concept of available short circuit power (ASCP). The latter is here defined as the AC voltage variation rejection capability of a system after a step in the reactive power demand ($ASCP \approx Q/\Delta V$). The concepts are also intertwined with the reachable active power transmission, and previous publications have investigated the issue [11],[12].

As the reactive power is not transferred to the DC network, it is reasonable, for this service, to restrict the focus to the onshore HVDC station. Assuming rated AC voltage ($V_{AC} = 1$ pu) at the converter's point of common coupling (PCC) and analysing the $Q-\Delta V_{AC}$ relationship when assuming lossless converter and AC network, the reactive power limitations due to converter rated current and available DC voltage are given with reasonable approximation by:

$$|Q| \leq \sqrt{\left(S_{nom} \cdot \frac{V_{AC}}{V_{AC,nom}}\right)^2 - P^2} \quad Q \leq (V_{AC}^{MAX} - V_{AC}) \cdot \frac{V_{AC}}{X_{ph}} \quad (1)$$

where S_{nom} is the nominal apparent power, P is the actual converter active power, X_{ph} is the reactance of the converter reactor and V_{AC}^{MAX} is proportional to the available DC voltage through well-known relations. Another limitation – that is roughly $|Q| \leq 0.5$ pu – is added based on literature [13]. Moreover, the AC network equation in the same space can be derived from literature [14] for the present simplified case:

$$Q = \frac{V_{AC}^2 - \sqrt{V_{AC}^2 V_g^2 - P^2 X_{SC}^2}}{X_{SC}} \quad (2)$$

where V_g and X_{SC} are the equivalent grid voltage and reactance respectively. The equations can be plotted in the $Q-\Delta V_{AC}$ space, resulting in Figure 2, that reports the case of short circuit ratio (SCR)

equal to 5 (left) and 1 (right). Taking losses into account would change the results quantitatively. However, the qualitative conclusions would be valid. The blue and black curves represent the first and second limits (1) respectively, while network equation (2) is plotted in orange for different values of P .

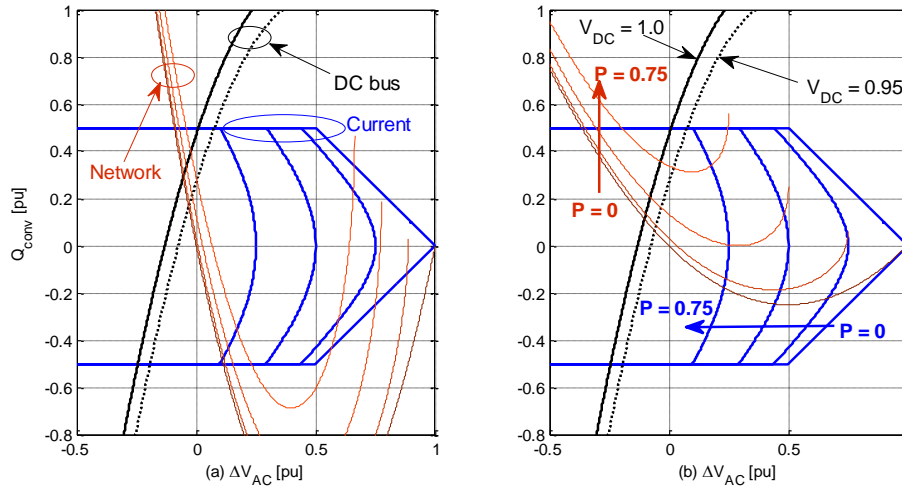

Figure 2 - VSC capability curves and AC network characteristics in the $Q-\Delta V_{AC}$ space. (a) SCR = 5.0, (b) SCR = 1.0. All quantities are in pu of converter ratings.

If the HVDC converter is provided with AC voltage droop control, the scenario for an initial active power production of $P = 0.5$ pu is depicted in Figure 3, where the behaviour of the system against a possible grid reactive power demand step (Q_L) is visualised. Many observations can be made on Figure 2 and Figure 3, but one that is particularly noticeable is the fact that for weak networks (i.e. SCR = 1), the network characteristic is slightly non-linear near the working point, while it is to a good approximation linear for stronger networks. This implies that the effective ASCP contribution of the VSC – decrease of equivalent short circuit reactance after its connection – depends on operational point and magnitude of the reactive power step. This is proved by Table 1, obtained running a set of dynamic simulations. With simple mathematical manipulations it is easy to assess that the ASCP contribution of an AC voltage droop controlling VSC is roughly equal to its droop gain K_{AC} .

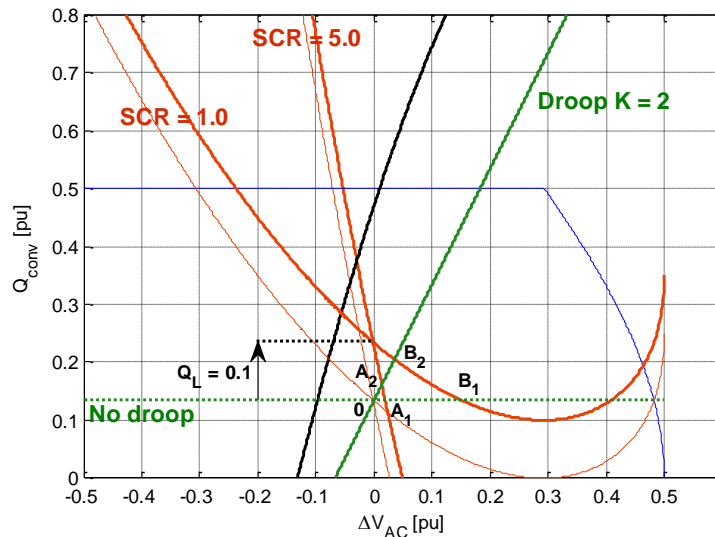

Figure 3 - Visualisation of steady-state AC voltage droop control in $Q-\Delta V_{AC}$ space. Thick orange lines represent the grid equation after reactive power step Q_L .

Dynamic aspects are discarded here, although they also play a role in the converter contribution to AC voltage control. Moreover, it is clear that, although the converter can efficiently contribute to ASCP, its contribution to the short circuit current during faults will not be greater than its rated current.

Table 1 - Equivalent ASCP after connection of VSC with AC voltage droop ($K_{AC} = 2$ pu). Results from non-linear dynamic model. ‘Ref’ refers to the case when the VSC is not connected.

		P [pu]→	0.08	0.16	0.4	0.56	-0.08	-0.16	-0.4	-0.56	Ref
$Q_L = 0.04$ pu	SCR = 1.0	2.97	2.97	2.88	2.77	2.97	2.97	2.87	2.73	0.96	
	SCR = 5.0	6.95	6.95	6.95	6.95	6.95	6.95	6.95	6.95	5.00	
$Q_L = 0.08$ pu	SCR = 1.0	2.96	2.96	2.88	2.75	2.96	2.91	2.86	2.72	0.91	
	SCR = 5.0	6.95	6.95	6.95	6.95	6.95	6.95	6.95	6.95	4.94	

4. FREQUENCY CONTROL

Contribution to onshore FC is considered state of the art for modern OWPPs and its provision through HVDC networks has been investigated in a number of publications, e.g. [6],[15]. The conclusion is that dynamic requirements are not very strict and even rather large control and communication delays can be accepted, especially when providing droop control, due to the usually slow dynamic envelop of AC frequency variations, as well as the sufficient capabilities of both OWPPs and HVDC converters. When the service includes inertial response, stricter limitations are imposed by the dynamics of the OWPP controller, and research in the area is on-going [6],[15].

Different approaches have been proposed for the provision of FC, mainly based on communication or on coordinated control of DC voltage and offshore frequency [6],[15]. Schemes based on coordinated control make use of local measurements only and are thus suitable for large networks. However, a communication-based scheme is deemed to be the most appropriate for small networks like the one in Figure 1. This is due to (i) the considered network configuration is simple, (ii) the dynamic requirements are quite loose and (iii) the coordinated control solution reduces the optimal utilisation of the DC network by decreasing the DC voltage during under-frequency events – in turn also decreasing the reactive power capability of the onshore HVDC stations (see also Figure 2).

In this specific case (Figure 1), a signal ΔP_{FC} can be derived by combining the frequency deviations in the two AC power systems. Then, it can be added to the power reference of the OWPP control according to Figure 4. It is well known that, in order for the OWPP to contribute with AC frequency droop in both directions, it must be in curtailed mode (power reserve) [16]. The figure reports also the signals for DC voltage control and POD, which will be described in the next sections.

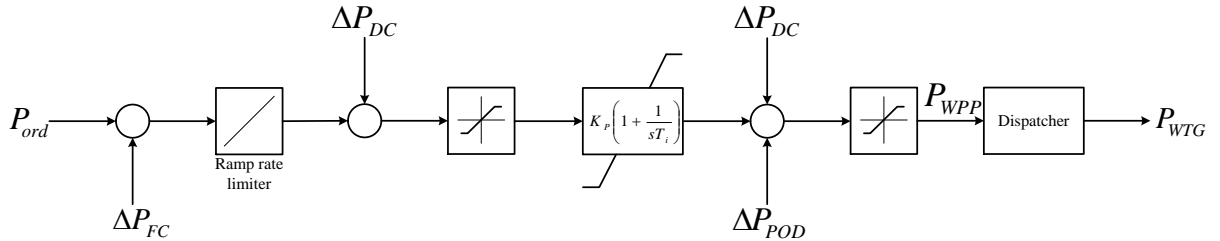

Figure 4 - Simplified block diagram of the OWPP controller.

5. POWER OSCILLATION DAMPING

Provision of POD from OWPPs and/or HVDC converters has been subject of past research, e.g. [17],[18],[19]. In such publications, an extensive treatment of the issue from a broad power system perspective is offered. However, a thorough description of the fundamental phenomena related to the simple – yet representative – onshore network in Figure 1 (Grid 1 in particular) is missing. It will be addressed by the authors in future publications, along with guidelines to set the control parameters taking into account effects of e.g. the voltage regulators for the synchronous machines, that are here supposed to be based on AC4A models [20]. Here, sample results are presented, to show the potential participation of HVDC and OWPPs in POD. This is done by:

- Designing a POD controller by deriving signals ΔP_{POD} and ΔQ_{POD} through a washout and lead-lag network as in [18]. These signals are used as power reference corrections in VSC1.
- Transmitting the active power signal ΔP_{POD} to the OWPP control and feeding it forward as input to the dispatch of the power to the wind turbines – according to Figure 4. This is done in

order to avoid the control delays and ramp rate limitations of the OWPP controller, which could be deleterious at the targeted frequencies and should be compensated for.

- Testing the connection of the VSC to both Bus 1 and Bus 2 (Figure 1) and benchmarking the performance against that of a standard power system stabiliser (PSS) – IEEE PSS1A [20] – installed at SG₁. This is done by imposing a fault at Bus 3, cleared after 3.5 cycles (70 ms).

The results are reported in Figure 5. The potential effectiveness is proved, especially for connection to Bus 1, while it is less satisfying when the converter is acting in the middle of the oscillation (Bus 2). This is well known [21]. However, it can be shown that if the electrical distance to a fast voltage regulator is sufficiently small, even contribution in the middle of the line can become relevant.

Among other issues that need to be taken into account during POD provision are the resonance frequency of the wind turbines' main drive train, communication delays (possibly to be compensated for by the controller) and exporting of the oscillations to neighbouring systems if the active power comes from a remote onshore converter rather than from the OWPP.

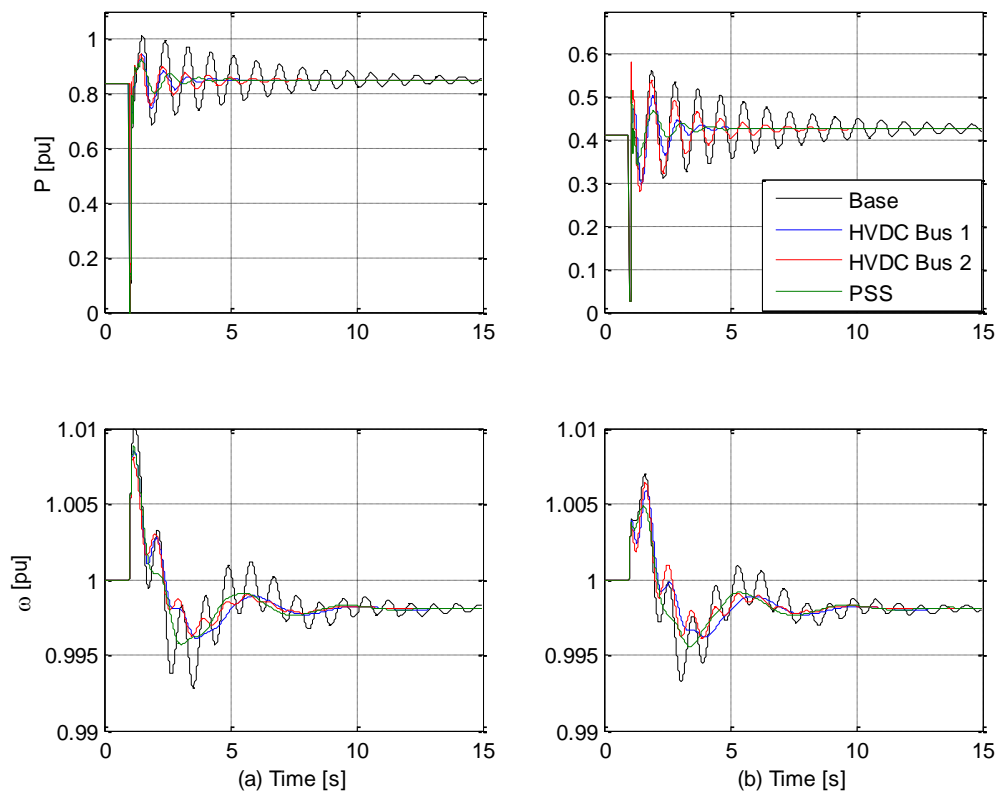

Figure 5 - System response to excitation of power oscillations and POD contribution from HVDC network. (a) Machine SG₁, (b) Machine SG₂.

6. DC VOLTAGE CONTROL

The control of the DC voltage for power balancing purposes is a more challenging task than controlling the AC frequency [5]. The time constants for DC voltage control can be one or two orders of magnitude shorter than for FC, due to the limited energy stored in the DC link. This becomes even more challenging when an OWPP needs to contribute to the control task, because of the inherent dynamic limitations associated with control and communication.

An exhaustive classification of DC voltage control schemes is provided by [5], that highlights how every control strategy proposed so far can be tracked down to a particular case of so called voltage droop. Further research has been directed to how OWPPs and AC grids can be integrated in the DC voltage control scheme – e.g. [22]. However, no attention has usually been paid to the real capability of the OWPPs and their dynamic limitations.

In multi-terminal DC networks, OWPPs can contribute quite effectively to the DC voltage control when their respective share represents a minor part of the total control power. On the other hand, due

to the limitations mentioned above, stability challenges arise when OWPPs are requested to be the main players in this control task. The solution to this challenge can be the utilisation of the other (faster) HVDC converters immediately after the disturbance to counteract initial rapid voltage drifts. The power from the OWPP can then be more smoothly supplied later to support during the last part of the dynamic response and during steady-state. This is implemented in practice by tuning the DC voltage control loop reported in Figure 6 according to where it is applied:

- For fast onshore HVDC converters, the filtering time constant T should be as low as 1-10 ms, and no dead-band is present – i.e. the continuous control of small variations is their duty. The derived output signal ΔP_{DC} is used as correction to the VSC power reference.
- For OWPPs, the time constant T can be chosen to be 100-500 ms and a dead-band can be used. The derived control signal (power reference ΔP_{DC}) is then fed forward through the OWPP controller, skipping the ramp rates and PI controller – see Figure 4.

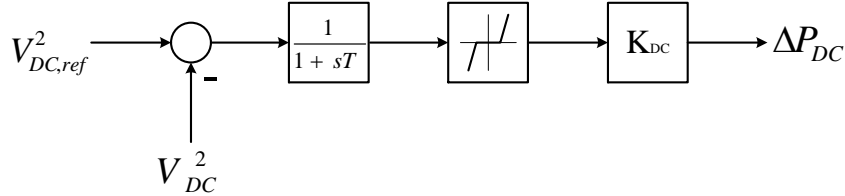

Figure 6 - DC voltage control loop for HVDC converters and OWPP.

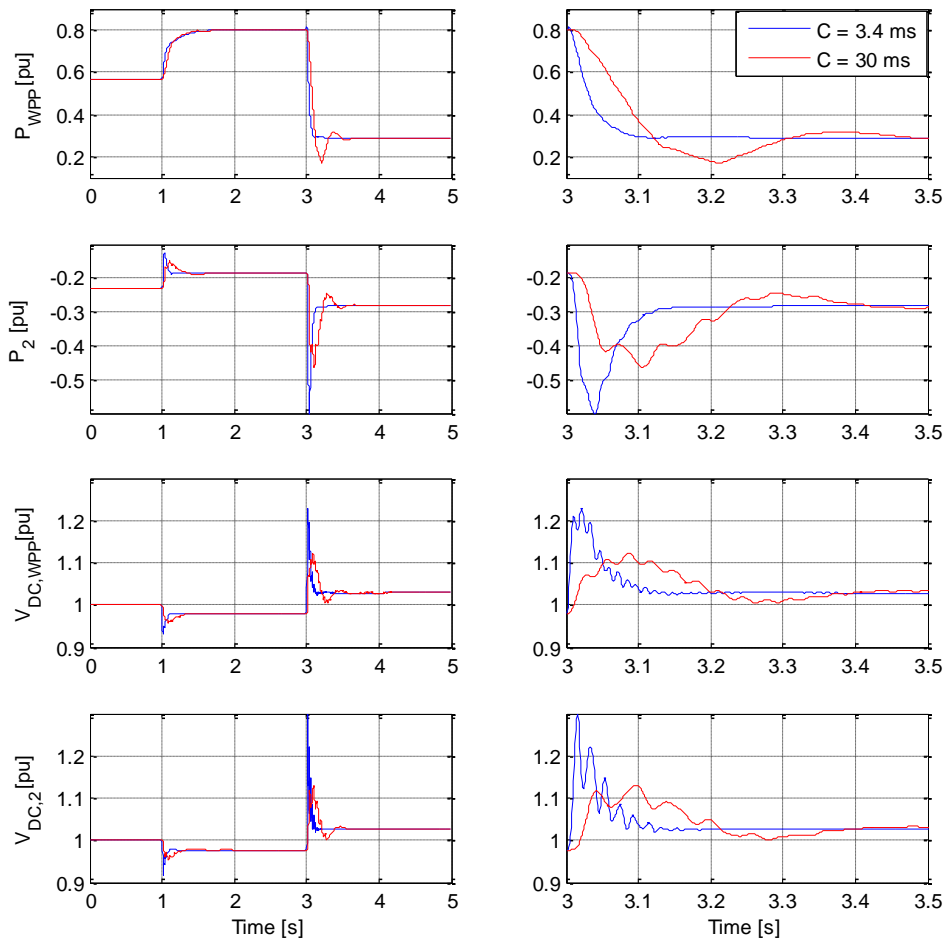

Figure 7 - System response to power step ($t = 1$ s) and outage ($t = 3$ s) of VSC1.

In Figure 7, results from a simulation are reported, where a step of -0.27 pu on VSC1 active power is tested, followed by the outage of the same converter (power imbalance ca. +0.6 pu). The steady-state

DC voltage control burden is mainly on the OWPP ($K_{DC} = 5$ pu) and partly on VSC2 ($K_{DC} = 1$ pu). The response is tuned by making the OWPP slower ($T = 0.2$ s) and VSC2 faster ($T = 1$ ms). The simulations were run for two values of the VSC capacitance (3.4 ms and 30 ms) representative of two-level converters and MMCs respectively¹. All pu quantities refer to a VSC rating.

It can be noticed that the price to pay for a stable and robust control of the voltage is an initial spike in the power modulation of VSC2 and a 100-200 ms long DC voltage drift – that can possibly be taken care of by the DC chopper when being over-voltage. This can be accepted with proper design of the DC link and if the onshore converters contributing to the first instants are connected to reasonably strong AC networks that can absorb the power spike without problems.

7. SHORT CIRCUITS

Short circuits in offshore AC network

Short circuits in the offshore AC network are a topic of crucial importance for the proper design of the OWPP, in particular in relation to protection philosophy and coordination. The topic has been treated in the literature – e.g. [7] – but more extensive studies are certainly needed to clarify (i) the possibilities offered by a largely controllable fault current in-feed, (ii) the usability of state of the art wind turbine’s fault-ride-through (FRT) algorithms and (iii) the challenges the control of power electronic converters may pose in terms of stability of the network and protection system design.

Short circuits in onshore AC network

When faults occur at the onshore HVDC stations, the VSC’s power transfer capability is more or less reduced, depending on (i) the severity of the fault and (ii) the VSCs’ FRT control algorithm. This creates a power imbalance in the DC network until the fault is cleared and the transmission capability is restored. The DC voltage then quickly drifts away from its rated value to dangerously high or low values. Possible methods to handle this include (i) distributed DC voltage control, (ii) utilisation of DC choppers or (iii) a combination of the two. If DC choppers are to contribute to regulation during under-voltages, they must be provided with a quickly chargeable/dischargeable energy storage system.

A compromise is therefore instituted between the VSCs’ DC voltage droop gains and the choppers’ ratings, assuming a desired maximum voltage drift and a certain worst-case maximum power imbalance, accompanied by the maximum fault duration. To illustrate this, a simulation scenario is considered where the OWPP is producing nominal power and VSC1 is exporting all of it. A severe fault occurs at $t = 1$ s at VSC1’s terminals. The maximum allowed DC voltage deviation is chosen to be 0.08 pu. A chopper is installed at VSC2’s DC side. Three chopper ratings are considered (1.0, 0.5 and 0.0 pu) and the DC voltage droop gain for VSC2 ($K_{DC,2}$) is selected for the three cases based on the common maximum DC voltage deviation (0.0, 2.5 and 5.0 pu respectively).

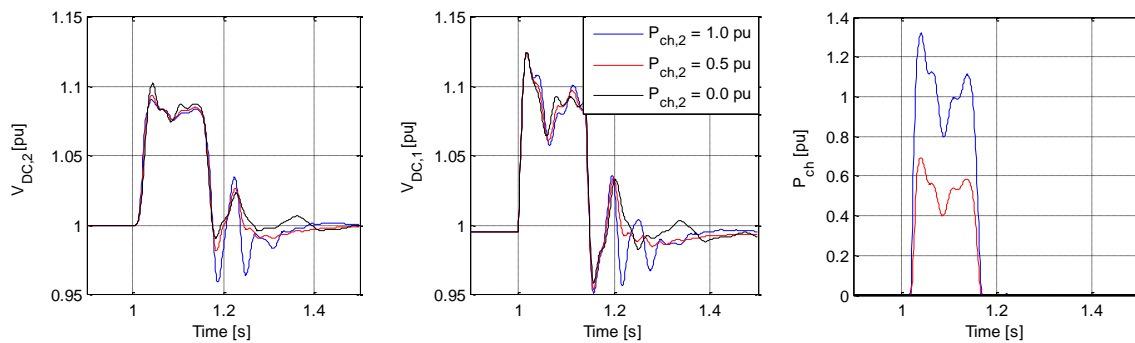

Figure 8 - Response to AC fault at VSC1. Diverse chopper ratings $P_{ch,2}$ and gains $K_{DC,2}$ are used.

Figure 8 shows the results, that prove that it is possible to substitute the chopper(s) with fast DC voltage control. Larger resonant voltage deviations are observed at VSC1, since the chopper is installed at VSC2. These are minor compared to what would be seen without any control action.

In general these considerations may be extrapolated to larger systems, with a total equivalent K_{DC} , a given maximum power imbalance, a desired DC voltage range and total available chopper(s) power.

¹ The capacitor time constant is defined here as rated energy divided by rated power, i.e. $0.5 \cdot C \cdot V_{rated}^2 / S_{rated}$.

Short circuits in DC network

Lack of devices and strategies for proper handling of short circuits in the DC network is the main technical show-stopper for the appearance of meshed DC grids to date [2]. Various solutions have been proposed and are available [2], but economic barriers still highlight the importance of investigating this challenge further.

8. BENCHMARKING WITH CONVENTIONAL UNIT

For every system service mentioned in this paper, it is important, from a TSO's perspective, to obtain knowledge as to how an HVDC station and OWPP perform as compared to a similarly sized power plant. A short paper cannot exhaustively analyse this, but a first qualitative assessment is as follows:

- **Onshore AC voltage control.** In general, the AC voltage control capability (or ASCP contribution) of a VSC is excellent. If well designed, an HVDC station can compete with a conventional machine and offer even more flexibility, particularly in under-excited scenarios.
- **Frequency control.** The capability of the HVDC network to provide frequency control is not depending solely on the VSC, but also on what lies behind the DC link. Provision of FC can be flexibly implemented and reach the same (or dynamically potentially better) performance as a conventional unit. This requires coordination with OWPPs and the other AC systems behind the DC link. For the former, power curtailment and proper market conditions are needed. For the latter, agreements between the involved TSOs are needed.
- **Power oscillation damping.** It has been observed (Figure 5) that HVDC converters can perform similarly to a conventional PSS in terms of POD, if they are placed at one end of the oscillation. Coordination with OWPPs is necessary to avoid possible mirroring of the oscillations in remote systems. In general, HVDC converters could substitute PSSs.
- **DC voltage control.** In this case, the benchmarking should be between conventional unit and OWPP. The former is potentially superior, due to its stored kinetic energy directly coupled to the grid, that can be released immediately for rapid DC voltage drifts by proper VSC control.
- **Short circuits.** In terms of SCP during actual short circuits, it is well known that VSCs contribute only with up to their rated current, while conventional machines transiently provide several pu short circuit current. This may make it necessary to over-size the VSC [23].

9. CONCLUSION

The paper has presented aspects related to the integration of HVDC connected OWPPs into the power system, particularly focussing on old and new system services. The study case in this paper is a three terminal DC network with one OWPP. The main focus was on onshore AC voltage control, POD contribution, DC voltage control and onshore AC faults.

Results concerning the characterisation of an HVDC station in terms of contribution to the AC voltage control were presented based on the analysis of the steady-state converter behaviour in the $Q-\Delta V_{AC}$ space, discussing the ASCP potential contribution, application of AC voltage droop and the influence of the network strength on its magnitude.

As for the provision of POD, it was shown that the service can be implemented efficiently especially when the HVDC station is placed at one side of the power oscillation. Some possible factors to be taken into account for the design were also pointed out.

DC voltage control was treated realistically taking into account the OWPPs' dynamic limitations, and illustrating the price the other DC nodes have to pay in order to guarantee robust power balance in the DC network if OWPP contribute substantially to the DC voltage control.

Onshore faults were treated by showing how DC choppers may become superfluous when the DC network expands. If they are to be utilised, their rating can be chosen as a compromise with fast voltage regulation from the healthy HVDC converters.

Other services have been mentioned from a state of the art perspective. Finally, a qualitative benchmarking with conventional units has been proposed. A qualitative discussion has been included in the paper in order to shed light on the most critical factors TSOs should focus on in the future when the networks they manage will host a large share of HVDC and wind power.

BIBLIOGRAPHY

- [1] Siemens, “Siemens Offshore Grid Connection Technology”, Siemens Wind Power, 15 Mar. 2013. [Online]. Available: <http://www.siemens.co.uk/en/wind/grid.htm>. [Last access 9 Apr. 2013].
- [2] Cigré WG B4.52, “HVDC Grid Feasibility Study”, (Cigré, Paris, 2013).
- [3] J. De Decker, P. et al., “Offshore Electricity Grid Infrastructure in Europe”, (Brussels, 2011).
- [4] P. Kundur, “Power System Stability and Control”, New York, McGraw-Hill, 1994.
- [5] T.K. Vrana, J. Beerten, R. Belmans and O.B. Fosso, “A classification of DC node voltage control methods for HVDC grids”, (Electr. Power Syst. Res., DOI: 10.1016/j.epsr.2013.05.001, 2013).
- [6] L. Zeni, I. Margaritis, A. Hansen, P. Sørensen and P. Kjær, “Generic Models of Wind Turbine Generators for Advanced Applications in a VSC-based Offshore HVDC Network”, (10th IET Conference on AC/DC Transmission, Birmingham, 2012, DOI: 10.1049/cp.2012.1980).
- [7] S. Chaudhary, “Control and Protection of Wind Power Plants with VSC-HVDC Connection”, (PhD thesis, Aalborg University, Denmark, 2011).
- [8] R. Sharma, “Electrical Structure of Future Off-shore Wind Power Plant with a High Voltage Direct Current Power Transmission”, (PhD thesis, Technical University of Denmark, 2011).
- [9] C. Heising, D. Meyer, R. Bartelt, M. Koochack Zadeh, T.J. Lebioda and J. Jung, “Power electronic asset characteristics for HVDC-connected offshore grids”, (11th Wind Integration Workshop, Lisbon, 2012).
- [10] L. Zhang, L. Harnefors and H.P. Nee, “Modeling and control of VSC-HVDC links connected to island systems”. (IEEE Trans. on Power Systems, ISSN:0885-8950, 26(2):783–793, May 2011).
- [11] J. Zhou and A. Gole, “VSC transmission limitations imposed by AC system strength and AC impedance characteristics,” (10th IET Conference on AC/DC Transmission, Birmingham, 2012, DOI: 10.1049/cp.2012.1986).
- [12] L. Zeni, H. Jóhannsson, A. Hansen, P. Sørensen, B. Hesselbæk, P. Kjær ”Influence of Current Limitation on Voltage Stability with Voltage Sourced Converter HVDC”, (4th European ISGT Conference, Copenhagen, 2013).
- [13] “HVDC Light – It’s time to connect”, (Technical brochure of HVDC Light based on MMC, ABB, December 2012 [Online] [Last accessed 12 December 2013]).
- [14] H. Jóhannsson, “Development of Early Warning Methods for Electric Power Systems”, (PhD Thesis, Technical University of Denmark, 2011).
- [15] Y. Pipelzadeh, B. Chaudhuri and T.C. Green, “Inertial response from remote offshore wind farms connected through VSC-HVDC links: a communication-less scheme”, (IEEE PES General Meeting, DOI: 10.1109/PESGM.2012.6345609, 2012).
- [16] G.C. Tarnowski, “Coordinated frequency control of wind turbines in power systems with high wind power penetration”, (Industrial PhD thesis, Technical University of Denmark, 2012. Available online).
- [17] T. Knüppel, ”Impact of Wind Power Plants with Full Converter Wind Turbines on Power System Small-Signal Stability”, (PhD Thesis, Technical University of Denmark, 2012).
- [18] A. Adamczyk, “Damping of Low Frequency Power System Oscillations with Wind Power Plants”, (PhD Thesis, Aalborg University, Aalborg, Denmark, 2012).
- [19] M. Ndreko, A.A. van der Meer, B.G. Rawn, M. Gibescu, M.A.M.M. van der Meijden, “Damping Power Oscillations by VSC-Based HVDC Networks: A North Sea Grid Case Study”, (12th Wind Integration Workshop, London, 2013).
- [20] D.C. Lee et al. “IEEE Recommended Practice for Excitation System Models for Power System Stability Studies”, (DOI: 10.1109/IEEESTD.1992.106975, March 19, 1992, IEEE).
- [21] M. Bongiorno, “Use of Power Electronic Controllers for Power Systems Stability Improvements”, (Report, Chalmers University, Gothenburg, Sweden, 2010).
- [22] T. Haileselassie and K. Uhlen, “Primary Frequency Control of Remote Grids Connected by Multi-terminal HVDC”, (IEEE PES General Meeting, DOI:10.1109/PES.2010.5589327 2010).
- [23] V. Akhmatov, A. Orths, P.B. Eriksen, H. Abildgaard and M. Powalko, “The Kriegers Flak Offshore Wind Power Plant Grid-connection Solution”, (12th Wind Integration Workshop, London, 2013).