



Inter laboratory comparison of industrial CT scanners

CIA-CT audit. Final report

Angel, Jais Andreas Breusch; Cantatore, Angela; De Chiffre, Leonardo

Publication date:
2012

Document Version
Publisher's PDF, also known as Version of record

[Link back to DTU Orbit](#)

Citation (APA):

Angel, J. A. B., Cantatore, A., & De Chiffre, L. (2012). *Inter laboratory comparison of industrial CT scanners: CIA-CT audit. Final report.*

General rights

Copyright and moral rights for the publications made accessible in the public portal are retained by the authors and/or other copyright owners and it is a condition of accessing publications that users recognise and abide by the legal requirements associated with these rights.

- Users may download and print one copy of any publication from the public portal for the purpose of private study or research.
- You may not further distribute the material or use it for any profit-making activity or commercial gain
- You may freely distribute the URL identifying the publication in the public portal

If you believe that this document breaches copyright please contact us providing details, and we will remove access to the work immediately and investigate your claim.

CIA-CT audit

Inter laboratory comparison of industrial CT scanners

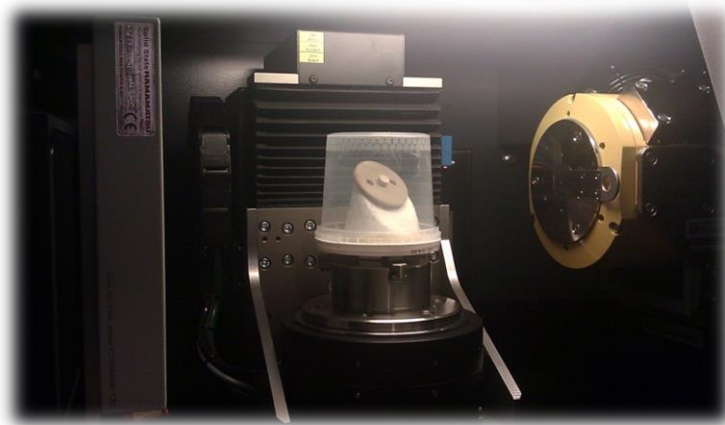

Final report

July 2012

Jais Angel, Angela Cantatore, Leonardo De Chiffre

Department of Mechanical Engineering

Technical University of Denmark

Abstract

In this report results from an intercomparison of industrial CT scanners are presented. Three audit items, similar to common industrial parts, were selected for circulation: a single polymer part with complex geometry (Item 1), a simple geometry part made of two polymers (Item 2) and a miniature step gauge produced using a polymer replica material (Item 3). The items circulated among six participants in Denmark and Germany. The circulation took place between March 2011 and June 2011. The items were measured according to a given protocol.

For Item 1 and Item 2 the selected geometrical features were height, diameter and roundness. Item 3 consisted of measurands as bidirectional and unidirectional distances. The polymer material of Item 1 was not described because of confidentiality. Item 2 was produced through a two component injection moulding process and consists of two polymers (polyetheretherketone for the disc and polyphenylenether for the top). Item 3 was fabricated by replication using a bisacryl material for dental applications (Luxabite).

Investigations on the parts' stability using a tactile Coordinate Measuring Machine (CMM), confirmed that polymers are not stable and change shape and dimensions over time. Stability of Item 1 and Item 2 was investigated over a period of eleven months. Reference measurements were carried out in three different time sequences and a maximum deviation of 31 μm was detected for Item 1, while a maximum deviation of 33 μm was detected for Item 2. A withdrawal of Item 3 was necessary during the proficiency testing, because the material was not hard and stable enough for CMM measurements.

It was important to avoid damages and limit contamination of the items during the circulation phase. Different experiments were made to select the correct sealing boxes for the items.

The inter laboratory comparison of industrial CT scanners produced a number of important results generating experience useful:

- Before testing applicability of CT scanning for measurement on the three small polymer items, their stability was investigated. Investigations on the parts' stability using a tactile Coordinate Measuring Machine (CMM), confirmed that polymers were not stable and change shape and dimensions over time. Stability of Item 1 and Item 2 was verified over a period of eleven months and a maximum deviation of 31 μm was detected for Item 1, when a maximum deviation of 33 μm was detected for Item 2. A significant form error was observed on the surface of Item 2, which influences the definition of the datums and the alignment. A withdrawal of Item 3 was necessary during the proficiency testing, because the material was not hard and stable enough.
- Regarding to the proficiency testing it was important to avoid damages and limit contamination of the items during the circulation phase. Different experiments were made to select the correct sealing box. It was seen that the density of the selected sealing box had an influence on the scanning results. The scanned result becomes better when the density of the sealing box is decreased. This phenomenon is due to the attenuation of the X-rays. The attenuation increases, when the geometrical thickness of the measuring object is increasing. A comparison between with and without sealing box was performed (a low

density sealing box was used, in this case polypropylene) through a scan and the experiment indicates that the difference did not exceed approximately 30 μm .

- Experiences from the participants and testing applicability of CT scanning showed following:
 - The definition of the measurement strategy should be more obvious and protection of the items during the circulation should be improved.
 - Labels on sealing boxes should be considered, because these tend to produce artefacts inside the scan. Therefore it is recommended placing the labels on the sealing boxes, where they cannot generate some noise inside the scan.
 - The used glue to fix the items generates beam hardening problems on the datums and surfaces, because the density of the glue was too close to the densities for Item 1 and Item 2.
 - The sealing boxes reduce the resolution and scanning quality of the items.
 - The interaction of multi materials generates beam hardening problems for Item 2.
- Measurements errors, trends and causes from the participants were the following:
 - There is a trend regarding Item 1, where the measured height by the participants seems to become lower compared to the reference value, with a maximum difference of 11 μm . The reason is that unidirectional measurements are not subject to specific uncertainty components such as threshold determination errors.
 - There is a trend regarding Item 2, where the measured roundness by the participants seems to be higher compared to the reference value, with a maximum difference of 30 μm . The reason was that form measurements were more problematic compared to the size measurements since form measurements are more affected by scatter and noise during the CT scanning process. This results in an overestimation of the form error values by the participants but, surprisingly, this phenomenon was not observed for Item 1. It can be due to the smaller voxel size for Item 1.
 - Most of the deviations from reference values were at the scale of the noise which the sealing box can generate.
- Regarding to the applied uncertainty models, 'Uncertainty evaluation based on the experience of the participant' (ISO 15530 series under development) and 'Uncertainty evaluation based on analytical budget of each uncertainty contribution' gave the best results in terms of agreement with reference measurement results for single polymers (Item 1). For multi materials (Item 2) 'Uncertainty evaluation based on analytical budget of each uncertainty contribution' gave the best results in terms of agreement with reference measurement results.



Preface

The 'Inter laboratory comparison of industrial CT scanners' CIA-CT audit was organized by DTU Department of Mechanical Engineering within the Danish project "CIA-CT: Centre for Industrial Application of CT scanning". The project was financed by the Danish Ministry of Science, Technology and Innovation. The project team at Centre for Geometrical Metrology (CGM), DTU Department of Mechanical Engineering was composed by:

Leonardo De Chiffre, Professor
Angela Cantatore, PostDoc
Jais Angel, Ph.D. Student
Pavel Müller, Ph.D. Student
Hans Nørgaard Hansen, Professor
René Sobiecki, Engineering Assistant
Jakob Rasmussen, Metrology Technician
Erik Larsen, Quality and Metrology Engineer, IPU Technology Development

Furthermore valuable contributions were given by:

Jan Lassen Andreasen, Dr., Novo Nordisk A/S
Peder Pedersen, Metrology Engineer, Danish Technological Institute (DTI)

The role as project coordinator was assumed by Ph.D. student Jais Angel, while the responsibility at CGM was taken by Professor Leonardo De Chiffre.

The project participants involved in the comparison are:

3D-CT A/S
Brock & Michelsen A/S, Carl Zeiss Industrielle Messtechnik GmbH
Danish Technological Institute, Metrology and Quality Assurance
Novo Nordisk A/S, Device R&D
Novo Nordisk A/S, DMS Metrology & Calibration
Zebicon A/S

Reference measurements were performed by René Sobiecki, Jakob Rasmussen and Erik Larsen at DTU Department of Mechanical Engineering.

Special thanks to all the participants as well as to the project team for their contributions to the project.

List of contents

Abstract	2
Preface	4
1. Project	6
1.1. Aim of the project.....	6
1.2. Project management and time schedule	7
1.3. Participants.....	8
2. Measurement procedure.....	9
3. Presentation of the items and some preliminary investigations to avoid damages through the circulation phase.....	10
3.1. Short description of the items.....	10
3.2. Selection of sealing boxes for the items	10
4. Reference values.....	14
4.1. Reference measurements.....	14
4.2. Measuring uncertainty.....	15
4.2.1. Substitution approach	15
4.2.2. PUMA approach	16
4.2.3. Probe force considerations	18
4.3. Item 1 – reference measurements and analysis of stability	19
4.4. Item 2 – reference measurements and analysis of stability	21
4.5. Item 3 – reference measurements and analysis of stability	24
4.6. Uncertainty considerations and material changes through time	27
5. Analysis of participants' data.....	30
5.1. Used industrial CT scanners, software and conducted measurements	30
5.2. Measurements carried out by participants.....	31
5.3. Applied voxel sizes	31
5.4. Problems reported by the participants.....	32
5.5. Main results for Item 1	33
5.6. Main results for Item 2	34
5.7. Analysis of the agreement between main results and reference measurement results....	36
5.8. Outline of the applied uncertainties by the participants	38
5.9. Temperature compensation	40
6. Summary and conclusions	41
7. References	43
8. Appendix.....	46

1. Project

The project was organized and coordinated by the Centre for Geometrical Metrology (CGM), Technical University of Denmark taking advantage of previous experience in other inter laboratory comparisons [Hansen et al., 1996] [De Chiffre et al., 2004]. Three audit items, similar to common industrial parts, were selected for circulation: a single polymer part with complex geometry (Item 1), a simple geometry part made of two polymers (Item 2) and a miniature step gauge produced using a polymer replica material (Item 3). The items circulated among six participants in Denmark and Germany. The circulation took place between March 2011 and June 2011. The items were measured according to a given protocol. Documentation, logistics, measuring protocols and reporting instructions were given in written form. The results of each participant are kept confidential. Each participant can identify their own results in the final report using an anonymous identification number provided by the coordinator. Each participant was responsible for following the protocols devised by the project coordinator. The protocols included documents which should be filled out [Angel et al., 2011]. Furthermore regarding the protocols, the items should be inspected and reported for errors and defects by the participants, when they received them.

1.1. Aim of the project

The aim of the comparison was to collect experience regarding the metrological performance of industrial CT scanning, when measuring small polymers items. The three items had to be considered more similar to industrial parts commonly measured in industry, which are less accurate and stable than reference artefacts. The main goals of the project can be summarized as follows:

- To test applicability of CT scanning for measurement on small polymer objects commonly measured in industry, which are less accurate and stable than reference artefacts.
- To evaluate the impact of different instrument settings and operator decisions on the measurements of items of different materials and geometry.
- To share knowledge of industrial CT scanning among the participants.
- To identify measurements errors and causes.

The items were circulated among six participants in Denmark and Germany to collect experience regarding the performance of industrial CT scanners for dimensional metrology.

The following was expected:

- To compare measurements and uncertainty models.
- To compare different parameter settings for performing the same measurement task.
- To indicate setting parameters for measurement optimization.

1.2. Project management and time schedule

The involved project phases were:

1. Plan, participants' definition.
2. Audit items calibrations.
3. Circulation.
4. Analysis of results.
5. Reporting and dissemination.

The timeline gives an indication of the used time for each of the phases and is given in Table 1.

The expected project period was delayed, by a reconstruction of the metrology laboratory at DTU during the measuring period, which can have influenced the stability of investigations because of vibrations, dirt, dust and misalignment of the used CMMs. Furthermore it restricted the access to the CMMs used for the project. As a result calibrations were performed before, during and after the circulation.

A final workshop is planned at DTU the 5th September 2012, where the participants can discuss and give contributions to the analysis of the inter laboratory comparison.

Table 1: Time schedule and milestones of the project.

Year	Month	Project phases				
		Plan, participants' definition	Audit items calibrations	Circulation	Analysis of results	Reporting and dissemination
2010	11					
	12					
2011	01					
	02					
	03					
	04					
	05					
	06					
	07					
	08					
	09					
	10					
	11					
	12					
2012	01					
	02					
	03					
	04					
	05					
	06					
	07					

1.3. Participants

A total number of six industrial CT scanners took part in the comparison. All the participants came from Denmark except from one participant from Germany. An overview of the participants in alphabetic order is given in Table 2, and a map of Germany and Denmark showing the locations of the participants is given in Figure 1. As indicated earlier, each participant can identify their own results in the final report using an anonymous identification number provided by the coordinator. It means that the order of the participants in alphabetic order in Table 2 is not related to the identification numbers.

Table 2: List of the participants in the circulation of the project in alphabetic order.

Participant	City	Country
3D-CT A/S	Nørresundby	Denmark
Brock & Michelsen A/S, Carl Zeiss Industrielle Messtechnik GmbH	Oberkochen	Germany
Danish Technological Institute, Metrology and Quality Assurance	Taastrup	Denmark
Novo Nordisk A/S, Device R&D	Hillerød	Denmark
Novo Nordisk A/S, DMS Metrology & Calibration	Hillerød	Denmark
Zebicon A/S	Billund	Denmark

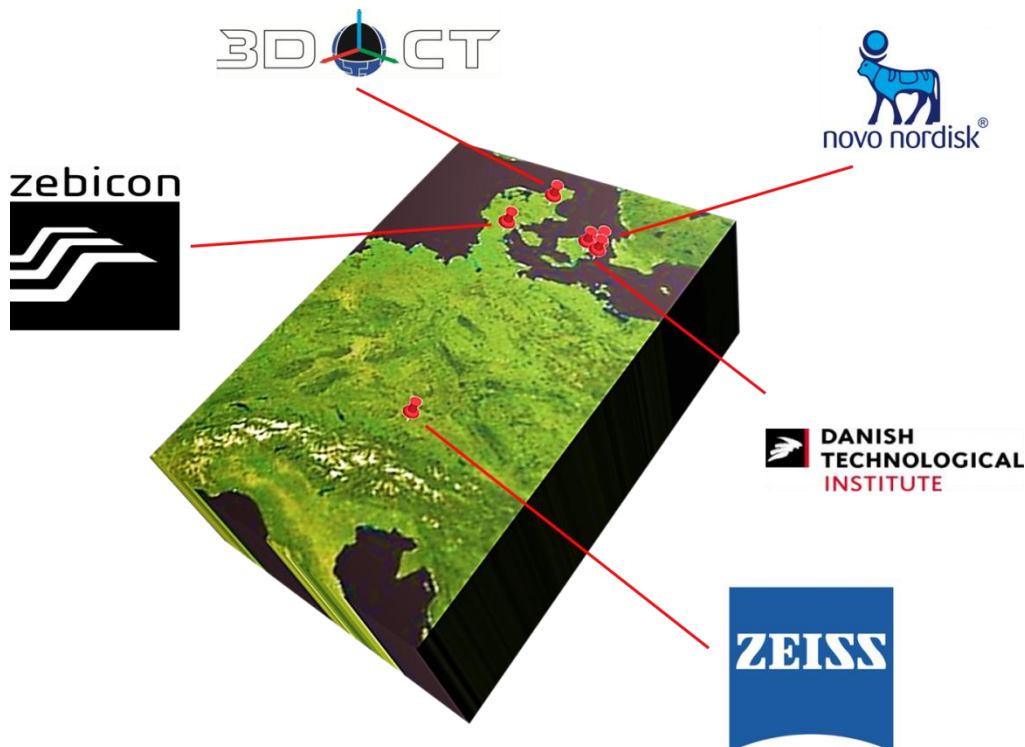

Figure 1: Map with an illustration of the location of the six participants in the circulation, where one is placed in Germany and the others in Denmark.

2. Measurement procedure

The participants were responsible for following the measurement procedures and instructions prepared by the project coordinator [Angel et al., 2011]. The procedures and instructions were sent by the project coordinator before the start of the circulation by email in formats which the participants had access for (the Microsoft Office package was used). The protocols include documents which should be filled out. The measurands should be measured regarding to the guidelines described in the protocols. Furthermore, the items should be inspected for damages and defects by the participants, when they received them. The CT scanning parameters were left to the participants' choice, to avoid limitation of their capabilities, and because it was impossible to specify the scanning parameters, when different CT scanners and participants were involved in the comparison.

A list of the measurement procedures and instructions documents provided by the project coordinator is presented in Table 3 from [Angel et al., 2011].

Table 3: List of the measurement procedures and instructions provided by the project coordinator

Content	Filename
<i>General overview of all three items</i>	
General overview and sequence of activities	CIA-CT_RR_I0.docx
<i>Item 1</i>	
Received form for Item 1	CIA-CT_RR_I1A.docx
Measurement procedure for Item 1	CIA-CT_RR_I1B.docx
Measurement result and report for Item 1	CIA-CT_RR_I1C.xlsx
Sending form for Item 1	CIA-CT_RR_I1D.docx
<i>Item 2</i>	
Received form for Item 2	CIA-CT_RR_I2A.docx
Measurement procedure for Item 2	CIA-CT_RR_I2B.docx
Measurement result and report for Item 2	CIA-CT_RR_I2C.xlsx
Sending form for Item 2	CIA-CT_RR_I2D.docx
<i>Item 3</i>	
Received form for Item 3	CIA-CT_RR_I3A.docx
Measurement procedure for Item 3	CIA-CT_RR_I3B.docx
Measurement result and report for Item 3	CIA-CT_RR_I3C.xlsx
Sending form for Item 3	CIA-CT_RR_I3D.docx

3. Presentation of the items and some preliminary investigations to avoid damages through the circulation phase

3.1. Short description of the items

The three small polymer items (called Item 1, 2 and 3) were chosen because they are more similar to industrial parts commonly measured in industry, which are less accurate and stable than reference artefacts commonly used for Coordinate Measuring Machines' calibrations and verifications. The three items are shown in Figure 2.

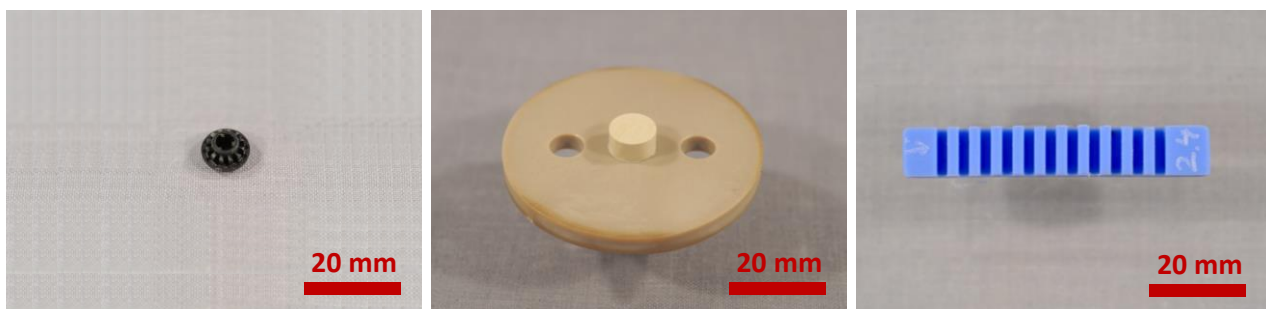

Figure 2: The three items, from the left Item 1, Item 2 and Item 3.

In connection with the discovered deformation of Item 3, the item was cancelled for the intercomparison and further investigations; see section 4.5. Item 3 was not implemented in the other sections of this report. Reference measurements of the items can be found in section 4.3, 4.4 and 4.5. Note that the cancelled sections for Item 3 can be found in Appendix.

3.2. Selection of sealing boxes for the items

Regarding to the proficiency testing it was important to avoid damages and limit contamination of the items during the circulation phase. Different experiments were made to select the correct sealing box. It was seen that the density of the selected sealing box had an influence on the scanning results. The scanned result becomes better when the density of the sealing box is decreased, as shown on Figure 3. This phenomenon is due to the attenuation of the X-rays. The attenuation increases, when the geometrical thickness of the measuring object is increasing. High-energy X-rays penetrate more efficiently than lower ones, but are less sensitive to changes in material density [Ketcham et al., 2001]. The reason is that the energy is not preferentially absorbed, as the linear attenuation coefficient generally decreases with increasing energy [Müller, 2010]. It is recommended to increase the energy of the X-ray depending on the material and thickness of the investigated object to ensure that the energy can penetrate the object [Simon et al., 2007]. Hence with constant energy and increasing atomic number, the maximum allowable penetration is decreasing [Kruth, 2010].

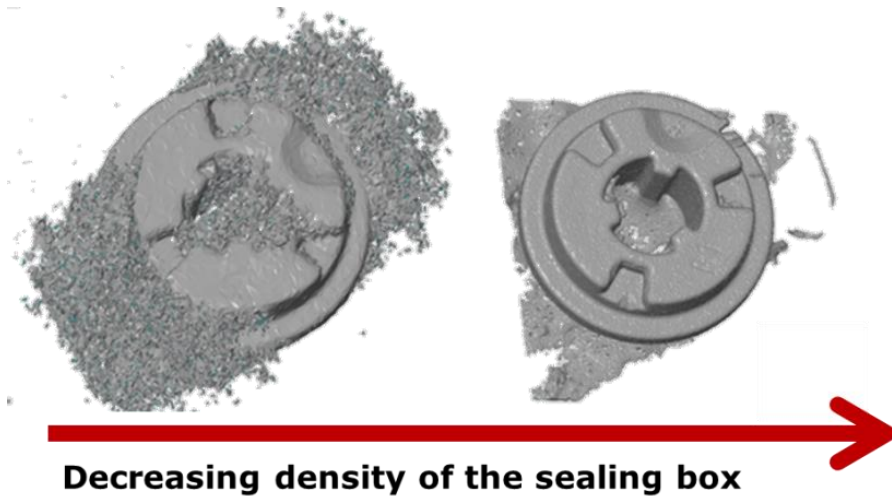

Figure 3: In this work, it was seen that the density of the sealing box has an influence on the scanning results, in this example for Item 1 (3D reconstruction in Calypso Software).

Examples of the sealing boxes for Item 1 and 2 are shown on Figure 4. In order to avoid noise at the border of the final scan, each item was mounted in expanded polystyrene and positioned at 45° with respect of the rotational axis. Figure 5 gives an idea of how Item 1 was fixed inside the expanded polystyrene and how the sealed chamber should be positioned on the rotary table. The flat surface of the lid of the sealed chamber should be placed downward.

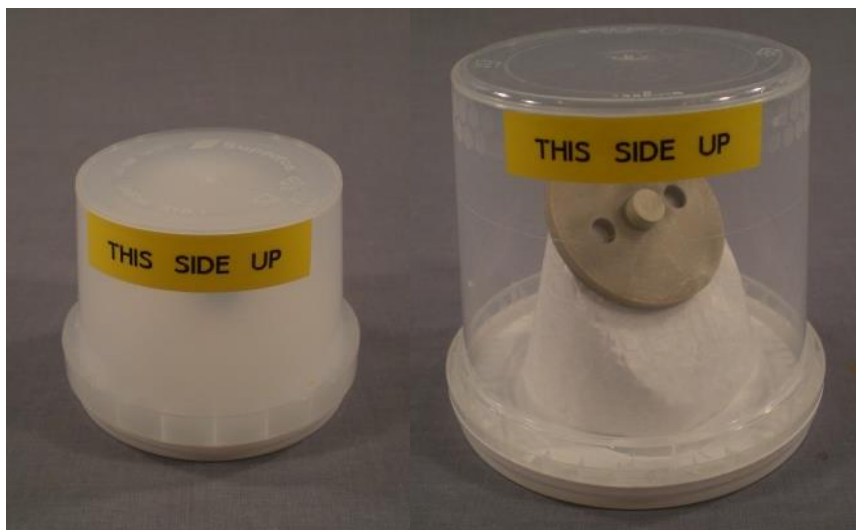

Figure 4: Examples of the sealing boxes for Item 1 (left) and 2 (right).

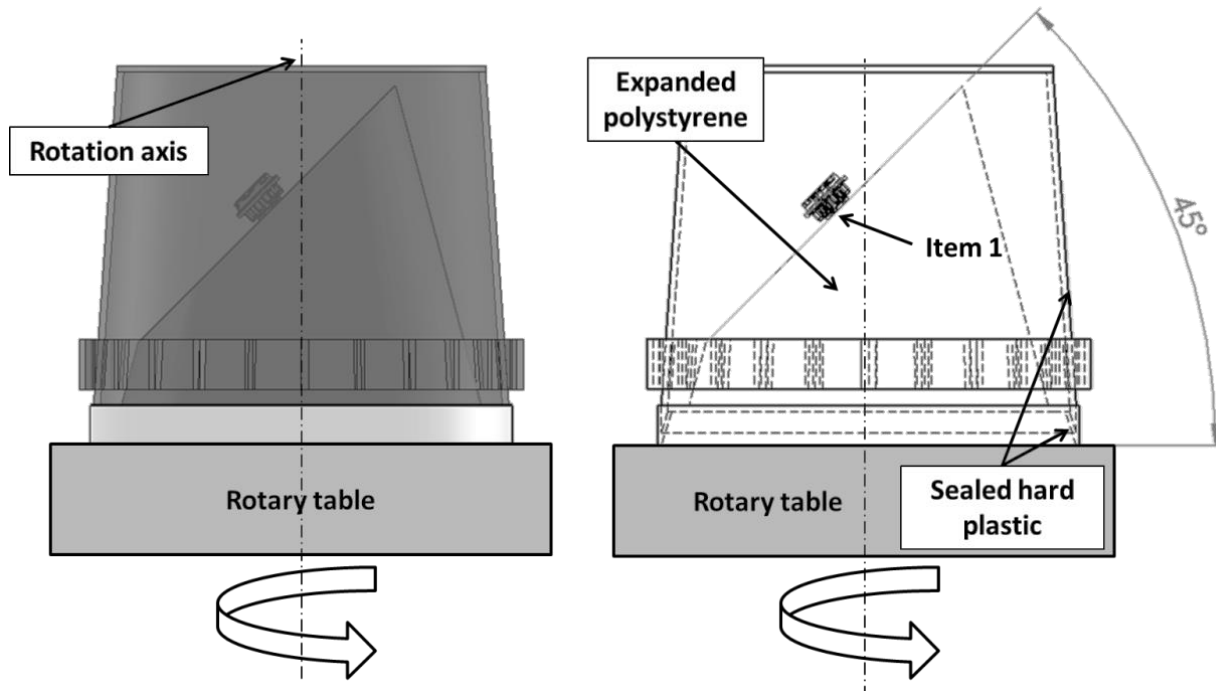

Figure 5: Example of recommended location of sealed chamber on the rotary table and position of Item 1.

A comparison between with and without sealing box was performed (a low density sealing box was used, in this case polypropylene (PP)) through a scan, see Figure 6. The colour map in Figure 6 indicates that the difference did not exceed approximately 30 μm . The density of PP is lower compared to water and much higher compared to air, see Table 4. Furthermore the density of the PP is lower than the densities of the used materials for Item 1 and Item 2, see Table 4. In Table 4, the thermal expansion coefficient is indicated too, for the materials which are relevant for the measurements. In this way it was expected that PP will influence the scanned results in a small or insignificant degree, when it acted as a sealing box. The boxes with the items were kept in a suitcase as shown on Figure 7. Both the items and the suitcase should be handled with care and it was required that the participants should use gloves when handling the items.

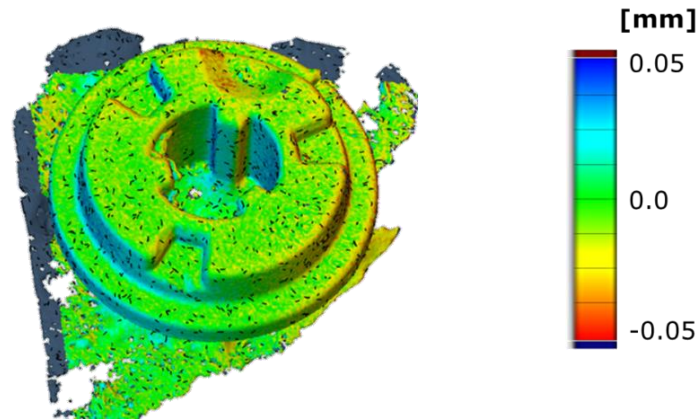

Figure 6: Colour map for comparison of the scan quality with and without sealing box (where a low density sealing box was used, in this case polypropylene) in GOM Inspect.

Table 4: Material characteristics.

Increasing density	Material	Density [kg/m ³]	Thermal expansion coefficient [10 ⁻⁶ K ⁻¹]
	Air at 20 °C and 101.325 kPa	1.29	Not relevant for the measurements
	Expanded polystyrene (used for fixture)	16-640	Not relevant for the measurements
	Polypropylene (sealing box)	855-946	Not relevant for the measurements
	Water	1000	Not relevant for the measurements
	A ethylene vinyl acetate copolymer mix (glue to bond fixture and industrial item)	1000-1100	Not relevant for the measurements
	Not specified (Item 1)	1150	140
	Polyphenylenether blends (Item 2, small plastic part)	1240	30
	Polyetheretherketone (Item 2, big plastic part)	1510	22



Figure 7: The items were protected in a suitcase.

4. Reference values

4.1. Reference measurements

Three different investigations were performed for the three items. The performed investigations were repeatability, reproducibility and stability of the items using tactile CMMs. The repeatability refers to measurements without moving the measured part, while the part was repositioned in the investigation of the reproducibility. Furthermore the stability of the parts was investigated through an interval of time in the period February 2011 to January 2012.

The CMM used at DTU to calibrate Item 1 and 2 was a tactile CMM equipped with a static probe. The CMM was of the type Zeiss UPMC 850 CARAT. Item 1 and 2 was measured using a probe with $\varnothing 1.0 \times 15$ mm and a probing force of 0.1 N. Six reversal measurement and transfer of traceability by comparator measurements were carried out. Item 1 was fixed using a screw, washer and nuts, see Figure 8.

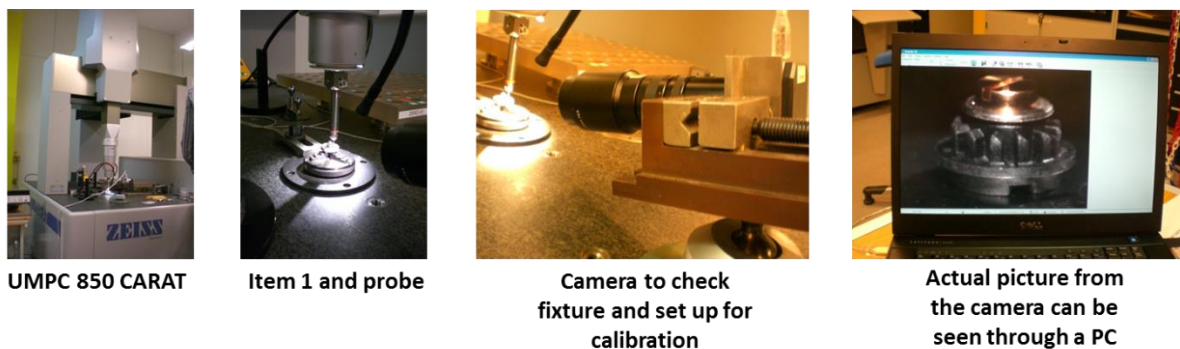

Figure 8: Setting up for Item 1 for transfer of traceability at DTU.

Item 2 was fixed using grips, see Figure 9.

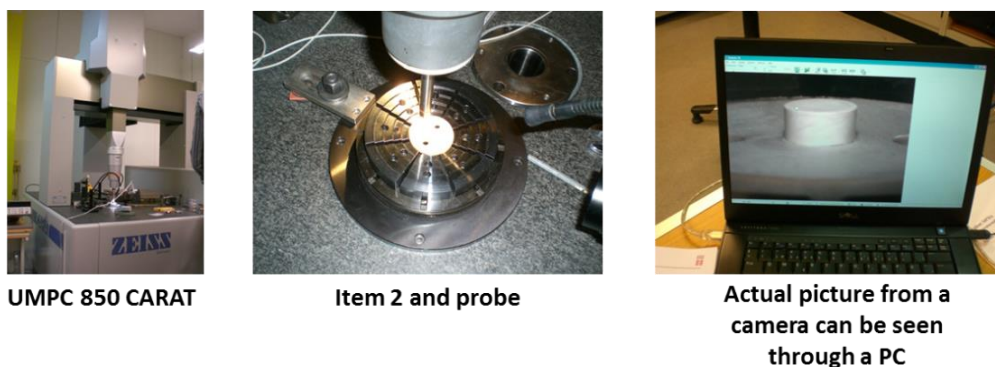

Figure 9: Setting up for Item 2 for transfer of traceability at DTU.

The CMM used at DTU to calibrate Item 3 was a tactile CMM equipped with a static probe. The CMM was of the type Zeiss OMC 850. Item 3 was measured using a probe with $\varnothing 0.8 \times 15$ mm and a probing force of 0.01 N. Five reversal measurement and transfer of traceability by

comparator measurements were carried out. Setting up for Item 3 for transfer of traceability at DTU is shown on Figure 10.



OMC 850

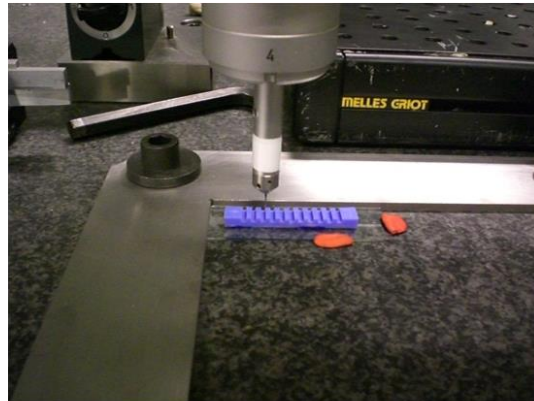

Item 3 and probe

Figure 10: Setting up for Item 3 for transfer of traceability at DTU.

4.2. Measuring uncertainty

4.2.1. Substitution approach

For estimation of the uncertainty for Item 1 and 2 the substitution approach [ISO TS 15530-3, 2011] was used. This method uses calibrated work pieces. The procedure starts with repeated measurements on calibrated work pieces with same conditions of the actual measurands. For estimation of the uncertainty Equation 1 was used.

$$U = k \cdot \sqrt{u_c^2 + u_p^2 + u_w^2 + u_b^2}$$

Equation 1

A description of each of the symbols in Equation 1 can be found in Table 5 [De Chiffre, 2011]. In this work it was assumed that, when the contribution of the systematic deviation between indicated value of the CMM and the calibrated value of the calibrated work piece (b) is larger than the other contributions, then it should be compensated and assumed that $u_b = 0$ in Equation 1. If the systematic deviation was small compared to the other contributions, then it is assumed that $u_b = b$ in Equation 1.

Table 5: Description of the symbols used in Equation 1.

Symbol	Description
U	Estimated uncertainty
k	Coverage factor ($k=2$ for a coverage probability of 95 %)
u_c	Standard uncertainty resulting from the uncertainty of the calibration of the calibrated work piece stated in the calibration certificate
u_p	Standard uncertainty resulting from the measurement procedure on CMM of the calibrated work piece
u_w	Standard uncertainty resulting from material and manufacturing variations (due to variations of expansion coefficient, form errors, roughness, elasticity and plasticity) ^A
$b \cup u_b$	Systematic deviation between indicated value of the CMM and the calibrated value of the calibrated work piece

A measuring uncertainty at 95% level ($k = 2$) was used for all values. The uncertainty U is given for each of the measurands for Item 1 in Table 6 and for Item 2 in Table 7. An illustration of the measurands can be found in section 4.3 for Item 1 and section 4.4 for Item 2.

Table 6: Uncertainty U for given measurands for Item 1.

Measurand identification	Uncertainty [μm]
Height, M_1	8
Diameter, M_2	22
Roundness, M_3	7

Table 7: Uncertainty U for given measurands for Item 2.

Measurand identification	Uncertainty [μm]
Height, M_1	7
Diameter, M_2	23
Roundness, M_3	1

4.2.2. PUMA approach

It was not recommended to use the substitution approach for Item 3, because the form error was too big, so the substitution approach will not give any effect compared to the GUM approach. It was decided to use the PUMA approach [ISO 14253-2, 2011], which is a simplification of GUM approach. For the PUMA approach, Equation 2 and Equation 3 were used.

$$U = u_c \cdot k \quad (k = 2)$$

Equation 2

$$u_c = \sqrt{u_{MPEX}^2 + \dots + u_{MX}^2 + \dots + u_{BX}^2 + \dots + u_{OX}^2 + \dots + u_{EX}^2 + \dots + u_{DX}^2 + \dots + u_{PX}^2 + \dots}$$

Equation 3

^A For this contribution only the standard deviation has been taken in consideration, since the used software correct for temperature and expansion.

A description of the symbols in Equation 2 and Equation 3 can be found in [De Chiffre, 2011]. Only the relevant and selected contributions from Equation 3 are explained in this report. Equation 2 and Equation 3 were simplified to Equation 4. A description of the symbols in Equation 4 can be found in Table 8.

$$U = k \cdot \sqrt{u_r^2 + u_m^2 + u_w^2 + u_{t1}^2 + u_{t2}^2 + u_{t3}^2 + u_p^2}$$

Equation 4

Furthermore U was the estimated uncertainty and k was the coverage factor ($k = 2$ for a coverage probability of 95 %).

For estimation of the uncertainty, the following components in Table 8 are included in the budget for Item 3. Note that the uncertainty components are divided in two categories; statistical methods (type A) and other methods than statistical (type B).

Table 8: Overview of the uncertainty components.

Number	Symbol	Description	Type
1	u_p	Uncertainty component coming from the measurement process	A
2	u_w	Uncertainty component coming from the combined form error of the measured features	B
3	u_{t1}	Uncertainty component coming from environment temperature difference for instrument	B
4	u_{t2}	Uncertainty component coming from environment temperature difference for artefact	B
5	u_{t3}	Uncertainty component coming from the deviation from the standard reference temperature	B
6	u_r	Uncertainty component coming from Grade I steel gauge blocks	B
7	u_m	Uncertainty component coming from the machine	B

A measuring uncertainty at 95% level ($k = 2$) was used for all values. The uncertainty U is given for each of the measurands for Item 3 in Table 9. An illustration of the measurands can be found in section 4.5.

Table 9: Uncertainty U for given measurands for Item 3.

Measurand identification	Uncertainty [μm]
Unidirectional type 1, M_{U1}	5
Unidirectional type 2, M_{U2}	8
Bidirectional type 1, M_{B1}	12
Bidirectional type 2, M_{B2}	28

4.2.3. Probe force considerations

In connection with the reference measurements before the circulation, a probe force test was performed to consider the deflection of the polymer materials depending on the used probe force. These experiments were only performed for Item 1 and Item 2, since it was only possible to adjust the probe force on Zeiss UPMC 850 CARAT.

The experiments were performed for 0.2, 0.4 and 1.0 N, and they were compensated with respect to a force of 0.1 N. The force of 0.1 N was used for creating a zero point. Six repeated measurements were made. The graph can be seen in Figure 11.

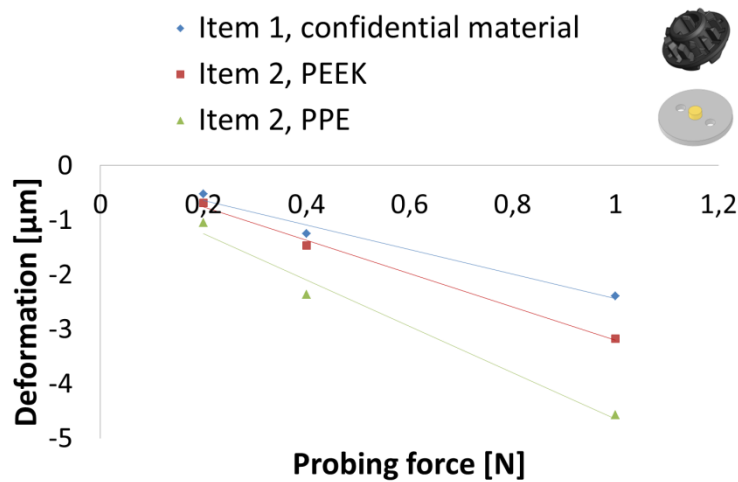

Figure 11: Performed probe force experiments. Note that PEEK is an abbreviation for polyetheretherketone (disc) and PPS is an abbreviation for polyphenylenether (top).

The average values have been compensated for systematic errors due to the force from the probe. For this the deflection from a contribution of 0.2 N has been used, and it has been compensated for a force of 0.1 N for creating a zero point.

4.3. Item 1 – reference measurements and analysis of stability

Figure 12 shows Item 1, the relevant datums and measurands.

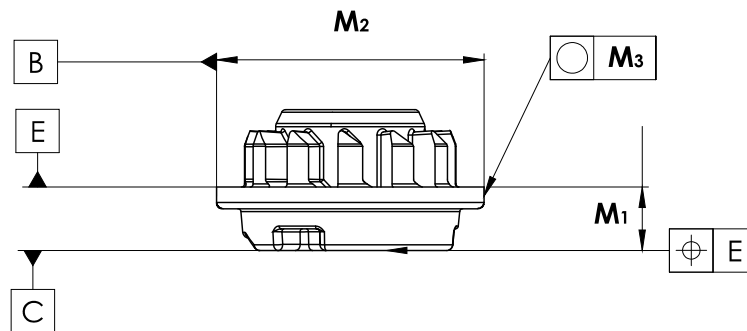

Figure 12: Item 1 with its relevant datums and measurands.

The nominal values of the three measurands for Item 1 are reported in Table 10, while the material characteristics have been described in Table 4. The detailed definition of the material characteristics and measurands were given in [Angel et al., 2011].

Table 10: Measurands on Item 1.

Measurand identification	Nominal value [mm]	Description
M1	2.05	Distance between planes (datum E and datum C)
M2	8.6	Diameter (datum B) measured at a distance of 0.25 mm from datum E
M3	-	Outer roundness (datum B) measured at a distance of 0.25 mm from datum E

Reference measurements were carried out before, during and after the circulation to check for traceability and repeated measurements. The comparison was carried out to validate the used reference data in the analysis. Six reversal measurement and transfer of traceability by comparator measurements were carried out for Item 1. The graph in Figure 13, which shows the variation of the reference measurements, can be used to evaluate repeatability and consistency of measurements [De Chiffre et al., 2004].

An example of the measurements of Item 1 before the circulation is given in Figure 13. Notice that the deviation of each measurement was based on the deviation between the measured value and the average value of the six measurements. Hence the repeatability shows a maximum deviation of 0.4 μm , when the maximum was 0.8 μm for reproducibility. These deviations seems acceptable due to the MPE for the CMM, which is defined as $MPE = 0.8 + L/600 \mu\text{m}$ (L in mm) [Angel et al., 2012].

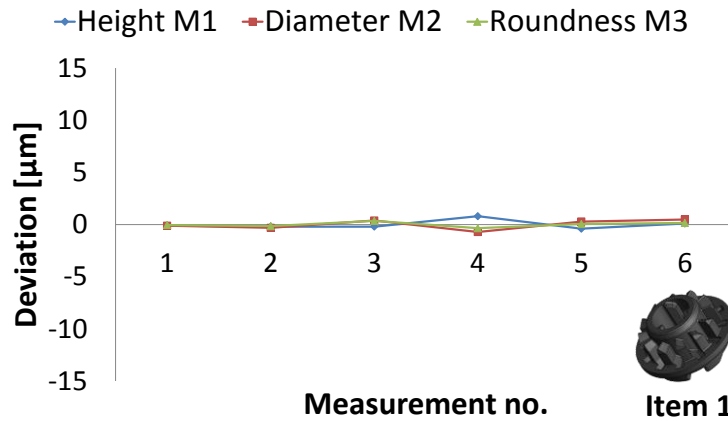
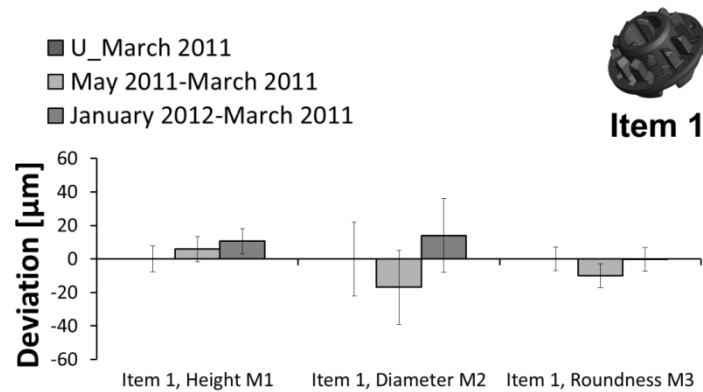

Figure 13: Variation of six reversal measurements. Note that for the three first measurements, Item 1 was not moved (repeatability), when it was moved and fixed again for measurement no. 4, 5 and 6 (reproducibility).

In the case of stability a comparison of values over an interval of time was carried out. An investigation on the stability of Item 1 was performed through reproduced measurements carried out in March 2011, May 2011 and January 2012. Deviations with respect to the first measurements are computed together with related uncertainties for Item 1 in Figure 14. It was detected that the item changed over a period of time. A maximum deviation of 31 µm was detected for diameter measurement of Item 1. The changes could be due to polymer characteristics, which were affected by temperature, humidity and air pressure.

Remark that a reconstruction was undertaken of the metrology laboratory during the measuring period, see section 1.2.



Measurand

Figure 14: Investigation on the stability of Item 1 performed through reproduced measurements carried out using a tactile CMM in March 2011, May 2011 and January 2012. Deviations with respect to the first measurements were computed together with related uncertainties.

4.4. Item 2 – reference measurements and analysis of stability

Figure 15 shows Item 2, the relevant datums and measurands.

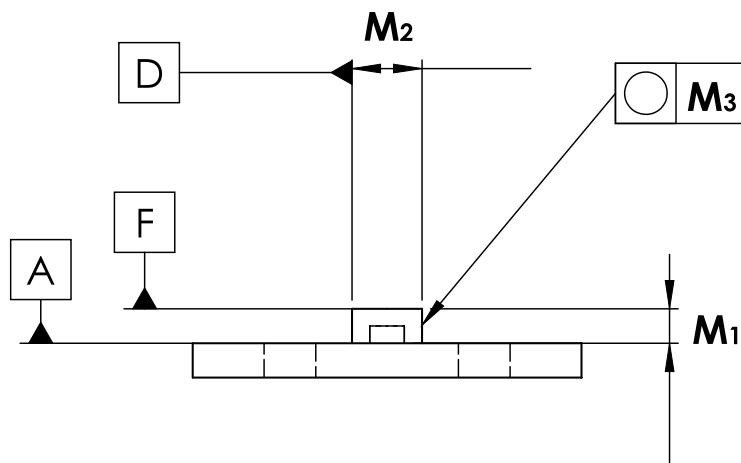

Figure 15: Item 2 with its relevant datums and measurands.

The nominal values of the three measurands for Item 2 are shown in Table 11, while the material characteristics are described in Table 4. The detailed definition of the material characteristics and measurands are given in [Angel et al., 2011].

Table 11: Measurands on Item 2.

Measurand identification	Nominal value [mm]	Description
M1	4	Distance between planes (datum F and datum A)
M2	8.1	Diameter (datum D) measured in a distance of 1 mm from datum A
M3	-	Outer roundness (datum D) measured in a distance of 1 mm from datum A

Six reversal measurement and transfer of traceability by comparator measurements were carried out for Item 2. An example of the measurements of Item 2 before the circulation is given in Figure 16. Notice that the deviation of each measurement was based on the deviation between the measured value and the average value of the six measurements. Hence the repeatability shows a maximum deviation of 0.4 μm , when the maximum was 2.2 μm for reproducibility. The deviation for repeatability seems acceptable due to the MPE for the CMM, when the deviation for reproducibility is high. It could be due to a significant form error obtained on the surface of Item 2, which influences the definition of the datums and the alignment, see section 5.4.

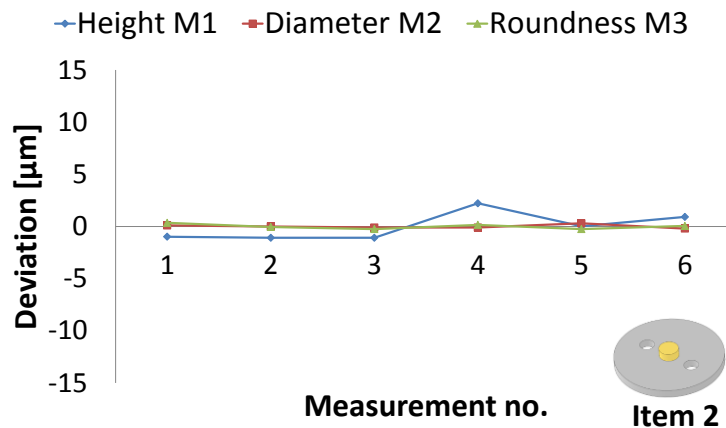
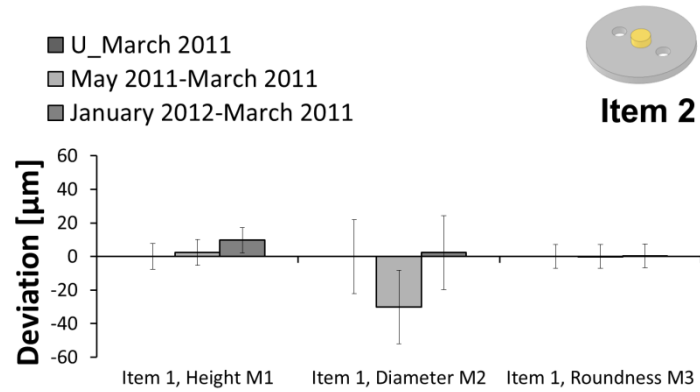

Figure 16: Variation of six reversal measurements. Note that for the three first measurements, Item 2 was not moved (repeatability), when it was moved and fixed again for measurement no. 4, 5 and 6 (reproducibility).

An investigation on the stability of Item 2 was performed through reproduced measurements carried out in March 2011, May 2011 and January 2012. Deviations with respect to the first measurements are computed together with related uncertainties for Item 2 in Figure 17. It was detected that the item changed over a period of time. A maximum deviation of 33 μm was detected for diameter measurement of Item 2. The changes could be due to polymer characteristics, which were affected by temperature, humidity and air pressure.

Remark that a rebuilding was undertaken of the metrology laboratory during the measuring period, see section 1.2.



Measurand

Figure 17: Investigation on the stability of Item 2 performed through reproduced measurements carried out using a tactile CMM in March 2011, May 2011 and January 2012. Deviations with respect to the first measurements were computed together with related uncertainties.

4.5. Item 3 – reference measurements and analysis of stability

Figure 18 shows Item 3 and the measurands.

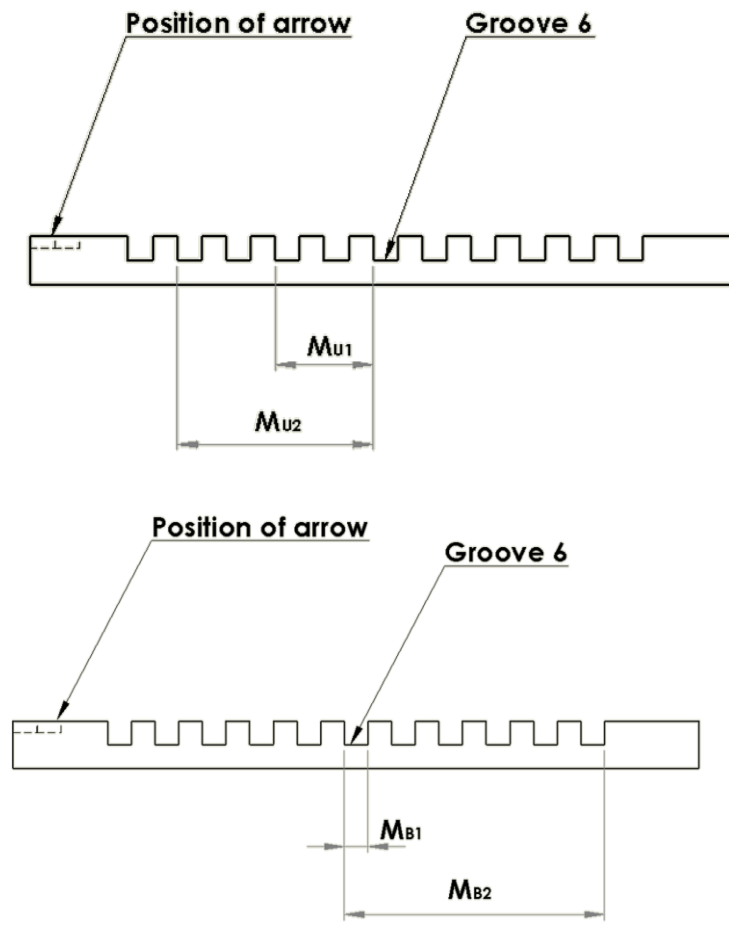

Figure 18: Item 3 with its measurands.

The nominal values of the four measurands for Item 3 are shown in Table 12. The density for Luxabite is 1.5 g/cm^3 , while the thermal expansion coefficient is $94 \cdot 10^{-6} \text{ K}^{-1}$. A detailed description of the material characteristics and measurands are given in [Angel et al., 2011].

Table 12: Measurands on Item 3.

Measurand identifier	Nominal value (mm)	Description
Unidirectional		
M _{U1}	8	Defined from the left side of the sixth groove to the left side of the fourth groove
M _{U2}	16	Defined from the left side of the sixth groove to the left side of the second groove
Bidirectional		
M _{B1}	2	Defined from the left side of the sixth groove to the right side of the six groove
M _{B2}	22	Defined from the left side of the sixth groove to the right side of the eleventh groove

Five reversal measurement and transfer of traceability by comparator measurements were carried out for Item 3. An example of the measurements of Item 3 before the circulation is given in Figure 19. Notice that the deviation of each measurement was based on the deviation between the measured value and the average value of the five measurements. Hence the repeatability shows a maximum deviation of 12.7 μm . The deviation for repeatability seems high due to the MPE for the CMM, which is defined as $MPE = 3+L/250\mu\text{m}$ (L in mm) [Angel et al., 2012].

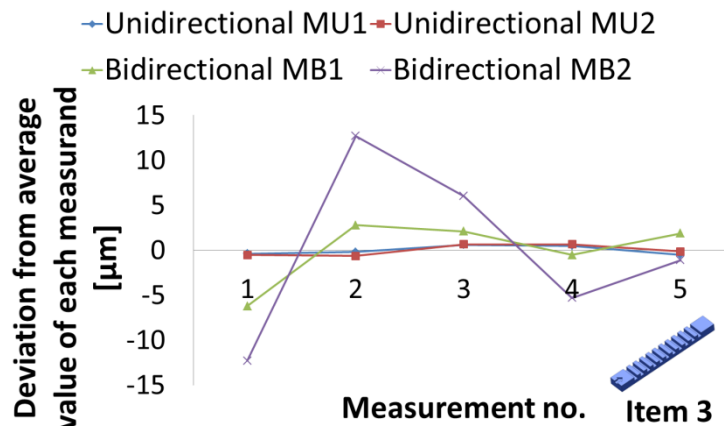

Figure 19: Variation of five reversal measurements. Note that for all the measurements, Item 3 was not moved (repeatability).

It can be seen that it influenced the variation, when measuring bidirectional measurands M_{B1} and M_{B2}, where the variation was bigger for M_{B2}. The reason for the small variations for unidirectional measurands M_{U1} and M_{U2} is that the unidirectional incremental distances compensates for the systematic error. This is not the case for bidirectional measurands M_{B1} and M_{B2}. It can be seen that the variation was bigger for M_{B2} compared to M_{B1}, it was because of the longer distance.

An investigation on the stability of Item 3 was performed through reproduced measurements carried out in February 2011, June 2011 and August 2011. Deviations with respect to the first measurements are computed together with related uncertainties for Item 3 in Figure 20. It was detected that the item changed over a period of time. A maximum deviation of 24.5 μm was detected for the longest bidirectional measurement (M_{B2}) of Item 3.

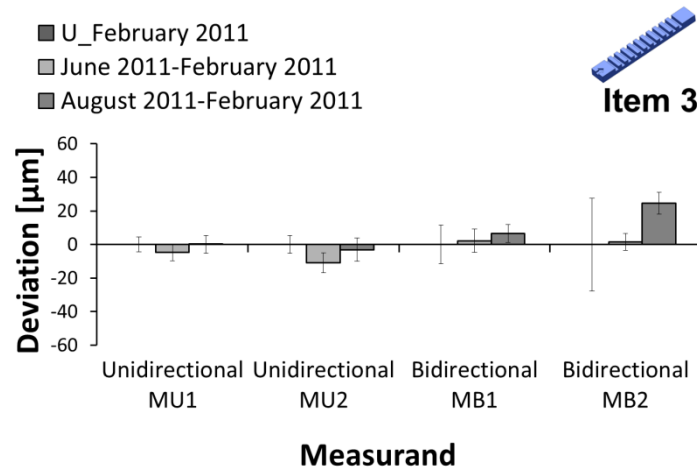

Figure 20: Investigation on the stability of Item 3 performed through reproduced measurements carried out using a tactile CMM in February 2011, June 2011 and August 2011. Deviations with respect to the first measurements were computed together with related uncertainties.

In connection with the discovered deformation of Item 3, the item was withdrawn from the intercomparison and further investigations. Results showed a maximum deviation below 6 μm on incremental distances (over a maximum bi-directional incremental distance equal to 22 mm), with standard deviations on five repeated measurements higher than 30 μm for same measurements. This high standard deviation values pointed out problems associated to repeatability, due to the presence of holes in correspondence to the CMM probing points (average peak to valley height = 16.8 μm and average maximum width = 345.2 μm). The material was not hard and stable enough. This was quite surprisingly, since previous experience using Luxabite had shown good stability over a year [Cantatore et al., 2010]. Most probably, the material properties vary among different production lots, and the new lot was less stable than the precision one.

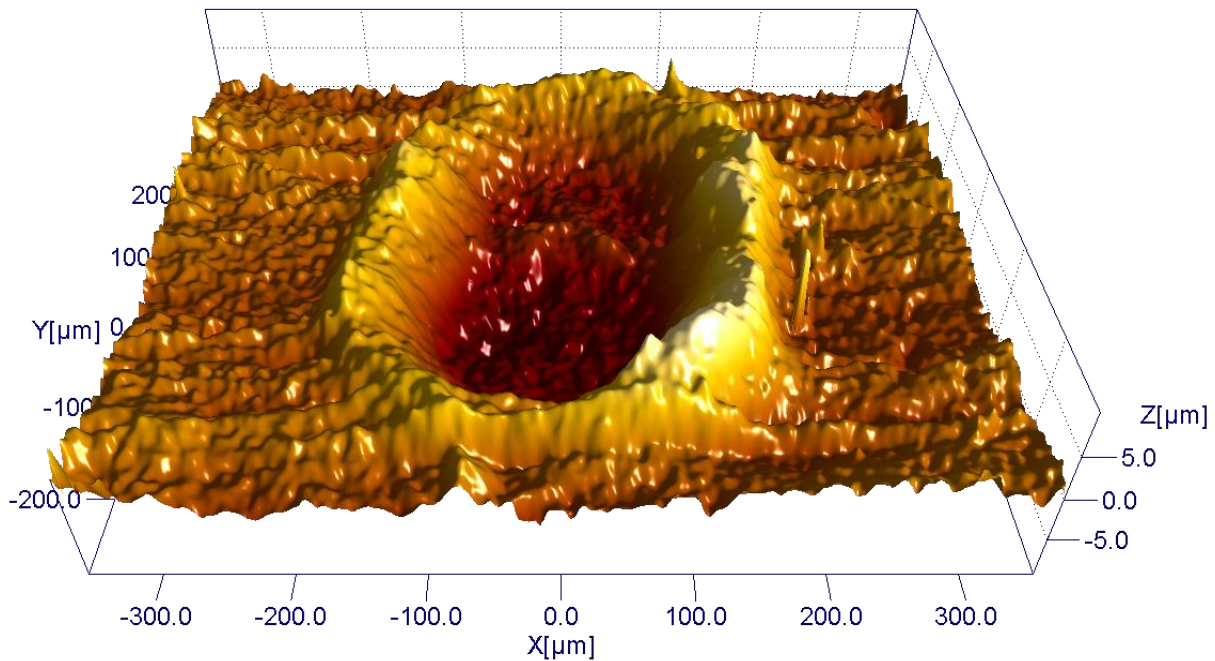

Figure 21: Example of hole present after CMM probing on the surface of Item 3. Holes were measured using Infinite Focus microscope by Alicona at DTU.

4.6. Uncertainty considerations and material changes through time

In order to judge the agreement between measurements through time, the E_n value normalised with respect to the stated uncertainty was computed according to ISO 17043 guidelines [ISO/IEC 17043, 2010], see Equation 5. If $E_n < 1$ the quality of the measurement result is acceptable, while it is not acceptable if $E_n \geq 1$.

$$E_n = \left| \frac{x_{lab} - x_{ref}}{\sqrt{U_{lab}^2 + U_{ref}^2}} \right|$$

Equation 5

Where x_{lab} is the obtained measurement and x_{ref} is the reference value, while U_{lab} and U_{ref} are the corresponding uncertainties.

In connection with the calculation of the E_n values, some of the measurands were not acceptable, because they had a value 1 or above. In this case it was necessary to consider correcting for this. There are two main reasons that the failure rate can exceed the expected level. Either the quoted uncertainty is too low or there is something atypically wrong with the measurement [Nielsen, 2004]. Of course, an interaction of these two problems can be considered in the same measurement. It was assumed that the measurements were ok and the quoted uncertainty has to be increased. The

procedure was performed by increasing the uncertainty related to the maximum difference between the three measurements ((A) before the circulation, (B) during the circulation and (C) after the circulation) to give an E_n value below 1 for the measurands which were not acceptable.

The corrections of the uncertainty were performed assuming that the uncertainties for cases A, B and C were equal ($U_{lab} = U_{ref}$) in Equation 5. Then Equation 5 was used to estimate the necessary uncertainty to give an E_n value below 1 for the non-acceptable measurands. The assumption for the calculations was as follows in three steps:

- First find $|x_{lab} - x_{ref}|$, which was assumed to be the maximum difference between the measured cases A, B and C
 - $|x_{lab} - x_{ref}| = \max(|x_A - x_B|, |x_A - x_C|, |x_B - x_C|)$
- Then calculate the estimated uncertainty U_{calc} , which was given as
 - $U_{lab}^2 + U_{ref}^2 = 2 \cdot U_{calc}^2$
- Then the calculated U_{calc} value should be compared to the original U values (U_A , U_B and U_C) and the following statements were used for the estimation of U :
 - If $U_{calc} \geq \max(U_A, U_B, U_C)$ then $U = U_{calc}$
 - If $\min(U_A, U_B, U_C) \leq U_{calc} \leq \max(U_A, U_B, U_C)$ then $U = \max(U_A, U_B, U_C)$
 - If $U_{calc} \leq \min(U_A, U_B, U_C)$ then no changes should be made

A schematic overview of the items and their acceptable and non-acceptable measurands depending on the E_n values estimated from the maximum difference between the cases A, B and C is given in Table 13.

Table 13: Overview of the items and their acceptable and non-acceptable measurands depending on the E_n values estimated from the maximum difference between the cases A, B and C.

Item no.	Measurand identification	Acceptable E_n value	Non-acceptable E_n value
1	Height, M_1		✗
1	Diameter, M_2		✗
1	Roundness, M_3		✗
2	Height, M_1		✗
2	Diameter, M_2		✗
2	Roundness, M_3	✓	
3	Unidirectional type 1, M_{U1}	✓	
3	Unidirectional type 2, M_{U2}		✗
3	Bidirectional type 1, M_{B1}	✓	
3	Bidirectional type 2, M_{B2}		✗

The estimated uncertainties to ensure that the non-acceptable E_n values will become acceptable are given in Table 14. Likewise, the E_n values after correction of the non-acceptable ones can be read from Table 14.

Table 14: Overview of the estimated uncertainties to ensure that the non-acceptable E_n values will become acceptable estimated from the maximum difference between the cases A, B and C. All values are in μm .

Item no.	Measurand identification	U_A	U_B	U_C	U_{calc}	Corrected estimated uncertainty	Acceptable E_n value
1	Height, M_1	1	0	2	8	8	✓
1	Diameter, M_2	1	1	1	22	22	✓
1	Roundness, M_3	1	1	1	7	7	✓
2	Height, M_1	3	0	4	7	7	✓
2	Diameter, M_2	1	1	1	23	23	✓
2	Roundness, M_3	1	1	1	0	No change	✓
3	Unidirectional type 1, M_{U1}	5	5	5	3	No change	✓
3	Unidirectional type 2, M_{U2}	5	6	7	8	8	✓
3	Bidirectional type 1, M_{B1}	12	7	5	5	No change	✓
3	Bidirectional type 2, M_{B2}	28	5	7	17	28	✓

5. Analysis of participants' data

The used industrial CT scanners and the measurement set-up used by the participants are described in this chapter. The measurements carried out on the industrial CT scanners are presented and data analysis illustrated.

5.1. Used industrial CT scanners, software and conducted measurements

The three items were measured on a total of six industrial CT scanners. Two of them were of the type Phoenix nanotom® m, while four of them were of the type Zeiss Metrotom 1500. Information of the used industrial CT scanners is given Table 15.

Table 15: Information about the industrial CT scanners used in the inter laboratory comparison. All data and information were acquired from the manufacturer's homepage.

Manufacturer, model	ZEISS Metrotom 1500	Phoenix nanotom® m
Max tube power [W]	225	15
Max voltage [kV]	225	180
Detector area [pixels]	Normally applied: 1024 x 1024 Optional: 2048 x 2048	3072 x 2400
Pixel size [µm]	Normally applied: 400 Optional: 200	100
Max object weight [kg]	50	3
Maximum part size [mm ²]	Ø300 x 350	Ø240 x 250
Cabinet size [mm ³]	3100 x 2223 x 2150	1600 x 1420 x 740
Application	Destruction-free testing, dimensional metrology, reverse engineering, comparison of geometries	Electronic devices, material science, turbine blades, casting, material science, sensor technology, 3D dimensioning

4 participants used Calypso software for measurement extraction, while one participant used VG Studio Max and one participant did not handed out any information about software for measurement extraction.

As indicated in Table 16, one of the participants did not measure Item 1. The reason was because of problems with the glue, which was used to bond fixture and industrial item. For further information, see section 5.4.

Table 16: Conducted measurements by the participants.

Item	Number of CT systems that measured	Number of CT systems that did not measure	Total number of CT systems
Item 1	5	1	6
Item 2	6	0	6
Item 3	Cancelled, because of material stability and hardness problems		

5.2. Measurements carried out by participants

The measurement results of each participant in the circulation are reported in separate and confidential participant reports. The following measurement set-up data were provided:

- Anonymous identification number.
- CT scanner.
- Maximum permissible error (MPE).
- Cooling system.
- Number of performed scans.
- Initial temperature and final temperature.
- Scanning parameters.
- Processing parameters.
- Applied uncertainty methods.

Comparisons of participant's results are presented in the following. Some comparisons were performed for the following cases:

- Applied voxel sizes
- Problems detected by the participants
- Main results for Item 1
- Main results for Item 2
- Analysis of the agreement between main results and reference measurement results
- Outline of the applied uncertainties by the participants
- Temperature compensation

5.3. Applied voxel sizes

The smaller voxel size was applied for Item 1 compared to Item 2 as shown in Table 17. The voxel size for Item 1 was smaller, because the voxel size goes with the size of the items. The magnification can be increased and the voxel size decreased by moving the item closer to the X-ray source and reverse. That is why the voxel size is smaller for Item 1 compared to Item 2. The average voxel size for Item 1 was 16.1 μm , while it was 45.5 μm for Item 2. According to the participants it was possible to decrease the voxel size for both items, if the sealing box was removed as explained in section 5.4.

Table 17: Applied voxel sizes by the participants.

Participant no.	Voxel size for Item 1 [μm]	Voxel size for Item 2 [μm]
1	6.0 to 14.0	26.0 to 44.0
2	28.0	34.0
3	19.2	52.4
4	-	-
5	2.8 (no scale correction)	51.0 (no scale correction)
6	20.6	55.2
Average	16.1	45.5

5.4. Problems reported by the participants

Some problems were detected by the participants during the circulation phase. The most general problems were that:

- The definition of the measurement strategy for Item 1 was not obvious.
- A significant form error was obtained on the surface of Item 2, which influences the definition of the datums and the alignment.
- The used glue to fix the items generates beam hardening problems on the datums and surfaces, because the density of the glue was too close to the densities for Item 1 and Item 2. See examples from participant number 6 in Figure 22 and Figure 23 for Item 2.
- The sealing boxes reduced the resolution and scanning quality of the items.
- The interaction of multi materials generated beam hardening problems for Item 2.
- During the circulation Item 2 had gone loose in the connection between expanded polystyrene block and the lid of the plastic container.
- On Item 1 the yellow label on the top of the container had been moved, because it tends to produce artefacts inside the scan.
- On both items the label on the lid stating item number and more was damaged because it was placed where the participants supposed to fixate the items.

The glue which had been used influenced the Datum H1 and H2.

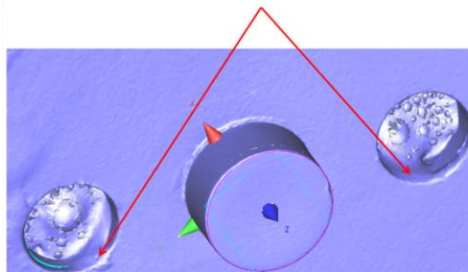

Figure 22: Example from participant number 6, where used glue had influenced the datums on Item 2. For further information of the location of the datums see [Angel et al., 2011].

The glue which had been used influenced the surface Z.

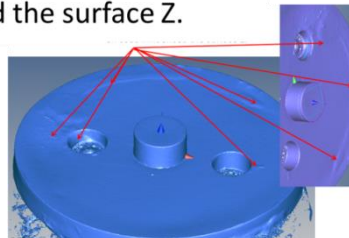

Figure 23: Example from participant number 6, where used glue had influenced the surface on Item 2. For further information of the location of the surface Z see [Angel et al., 2011].

5.5. Main results for Item 1

Main results are acquired and compared among the participants for the measurands; height, diameter and roundness for Item 1 in Figure 24, Figure 25 and Figure 26. It should be remarked that no data are acquired from participant number 4. The data from participant number 1, 3, 5 and 6 are acceptable, while the data from participant number 2 are critical. There is a trend for the case of height for Item 1, where the measured height by the participants seems to be lower compared to the reference value, with a maximum difference of 11 μm . This trend is in contrast to a trend for lengths stated in [Carmignato et al., 2011], where the measured lengths were longer compared to the reference values. Furthermore it is stated that unidirectional sizes are less problematic than bidirectional measurements [Carmignato et al., 2011]. The reason is that unidirectional measurements are not subject to specific uncertainty components such as threshold determination errors. Most of the deviations from reference values are at the scale of the noise which the sealing box can generate as explained in section 3.2.

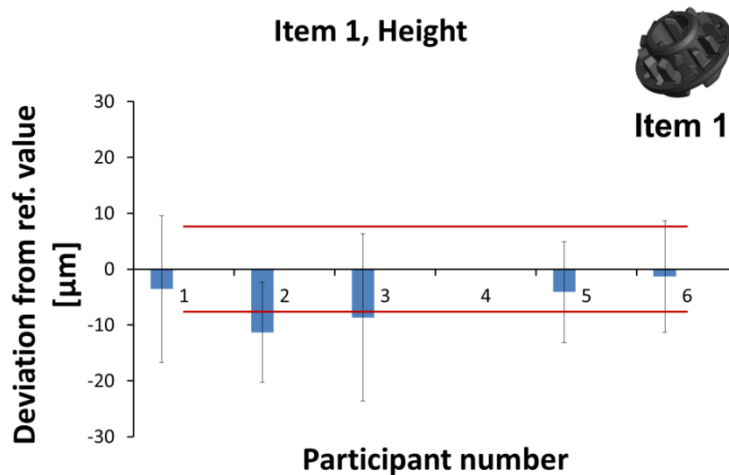

Figure 24: Deviation chart comparing the results obtained from all the participants except from participant no. 4 for Item 1 in the case of height. The red lines indicate the maximum reference uncertainty.

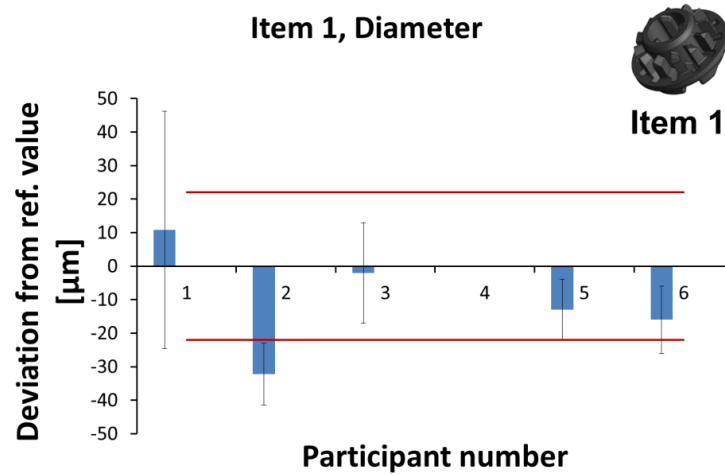

Figure 25: Deviation chart comparing the results obtained from all the participants except from participant no. 4 for Item 1 in the case of outer diameter. The red lines indicate the maximum reference uncertainty.

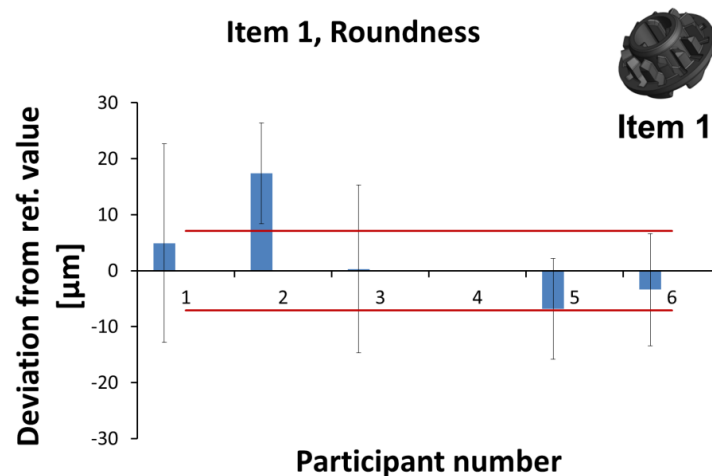

Figure 26: Deviation chart comparing the results obtained from all the participants except from participant no. 4 for Item 1 in the case of outer roundness. The red lines indicate the maximum reference uncertainty.

5.6. Main results for Item 2

Main results are acquired and compared among the participants for the measurands; height, diameter and roundness for Item 2 in Figure 27, Figure 28 and Figure 29. The data from participant number 1 and 3 are acceptable, while the data from participant number 2, 4, 5 and 6 are critical. Note that the case of the diameter is acceptable for participant number 4 and 5. There is a trend regarding Item 2, where the measured roundness by the participants seems to be higher compared to the reference value, with a maximum difference of 30 μm . The reason is that form measurements are more problematic compared to the size measurements since form

measurements are more affected by scatter and noise during the CT scanning process [Carmignato et al., 2011]. This results in an overestimation of the form error values by the participants but, surprisingly, this phenomenon was not observed for Item 1 in section 5.5. It can be due to the smaller voxel size for Item 1. Most of the deviations from reference values are at the scale of the noise which the sealing box can generate as explained in section 3.2.

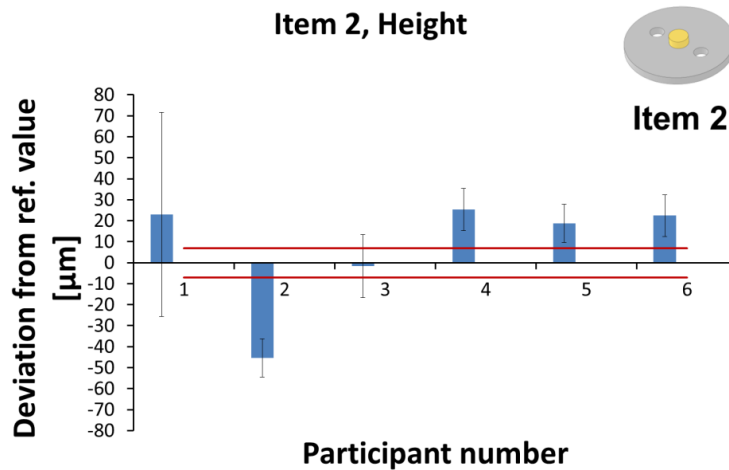

Figure 27: Deviation chart comparing the results obtained from all the participants for Item 2 in the case of height. The red lines indicate the maximum reference uncertainty.

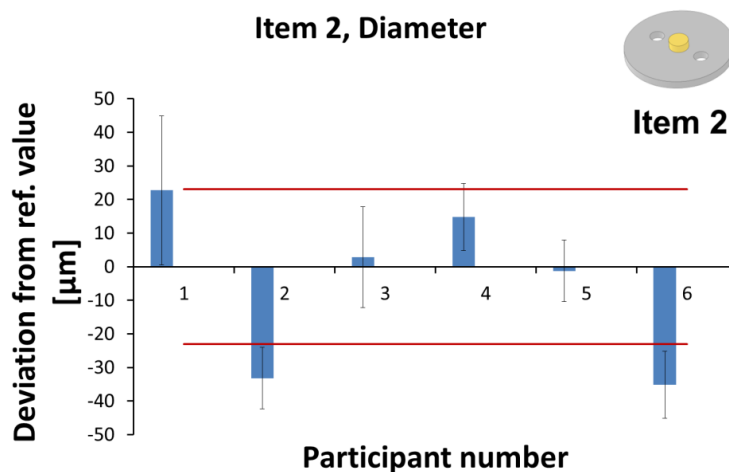

Figure 28: Deviation chart comparing the results obtained from all the participants for Item 2 in the case of outer diameter. The red lines indicate the maximum reference uncertainty.

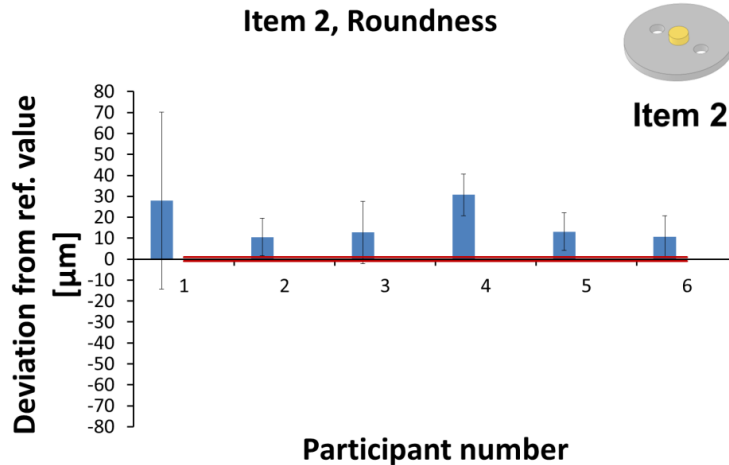

Figure 29: Deviation chart comparing the results obtained from all the participants for Item 2 in the case of outer roundness. The red lines indicate the maximum reference uncertainty.

5.7. Analysis of the agreement between main results and reference measurement results

In order to judge the agreement between measurements performed by each partner E_n values were used, see Equation 5. A value of $E_n < 1$ indicates agreement with reference measurement results. The reference values from March 2011 were used as reference measurement results.

Results are shown in Figure 30. From the intercomparison, Item 1 gives more stable results in comparison with Item 2, which is clear in Figure 31. This could be due to two different reasons: 1) beam hardening problems arising in CT scanning in presence of multi material objects; 2) a significant form error on the surface of Item 2, which influences on the definition of the datums.

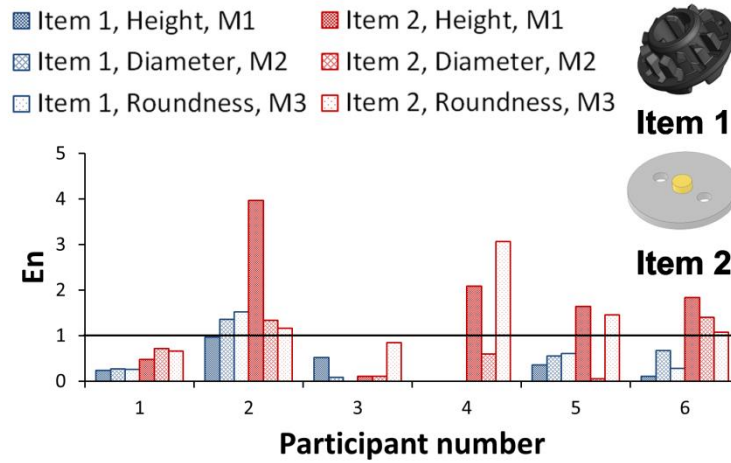

Figure 30: E_n chart comparing the results obtained from all the participants for Item 1 and Item 2 for all cases of measurands. A value of $E_n < 1$ assures agreement with reference measurement results.

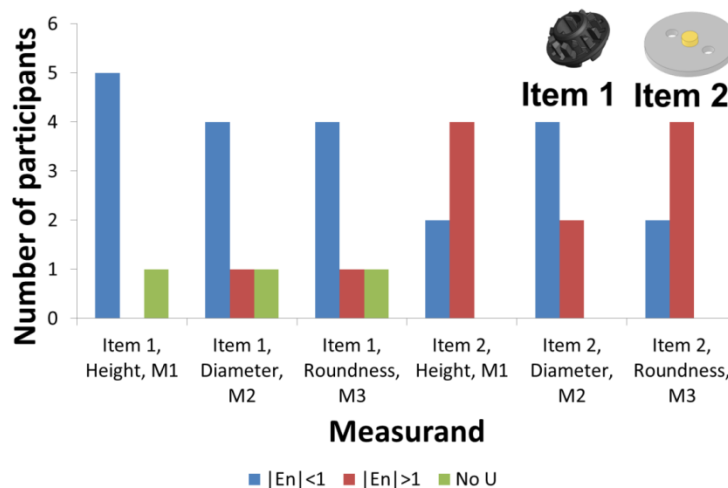

Figure 31: E_n chart showing the distribution of results, which were in agreement with reference measurement results for Item 1 and Item 2.

A histogram showing the distribution of all E_n values acquired from Item 1 and Item 2 is shown in Figure 32 and the distribution in percentage is shown in Table 18. About 58 % of the main results for Item 1 and Item 2 are in agreement with the reference measurement results.

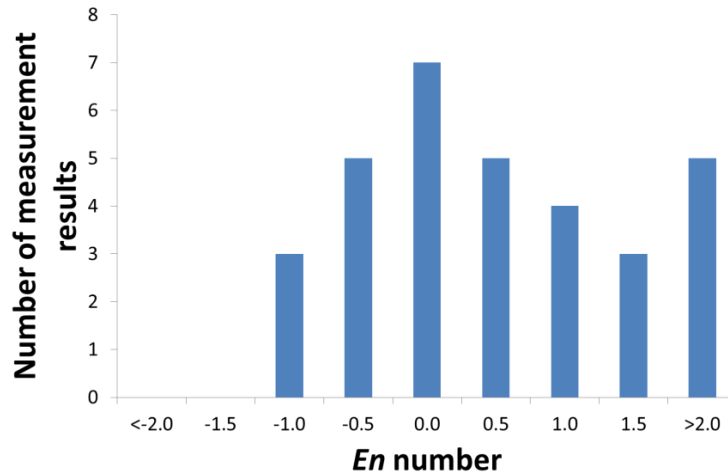

Figure 32: Histogram for the distribution of all E_n values acquired for Item 1 and Item 2.

Table 18: Overview of the distribution of E_n values in percentage.

Type of measurement results	Number of measurement results	Percentage [%]
$ E_n < 1$	21	58.3
$ E_n > 1$	12	33.3
Without uncertainty statement	3	8.3
TOTAL	36	100.0

5.8. Outline of the applied uncertainties by the participants

Outlines of the applied uncertainties by the participants are described in Table 19. Participants number 3, 5 and 6 used ‘Uncertainty evaluation based on the experience of the participant’ (ISO 15530 series under development). Participant number 1 used ‘Uncertainty evaluation based on analytical budget of each uncertainty contribution’ [ISO GUM, 2008]. Participant number 2 used ‘Uncertainty evaluation based on CT machine manufacture directions’ (ISO 15530 series under development). Participant number 4 had indicated an uncertainty value for the measured data for Item 2, but no information of the applied uncertainty was stated and it was therefore indicated as unknown in Table 19. For single polymers (Item 1) ‘Uncertainty evaluation based on the experience of the participant (ISO 15530 series under development) and ‘Uncertainty evaluation based on analytical budget of each uncertainty contribution [ISO GUM, 2008]’ gave the best results related to the agreement with reference measurement results. For multi materials (Item 2) ‘Uncertainty evaluation based on analytical budget of each uncertainty contribution [ISO GUM, 2008]’ gave the best results related to the agreement with reference measurement results.

Table 19: Outline of what uncertainty method was applied by the participants and the frequency of the given uncertainty.

Abbreviation for the applied uncertainty	Used uncertainties evaluation method	Frequency	Participant no.
U _A	Uncertainty evaluation based on the substitution method (ISO 15530 part 3 [ISO/TS 15530, 2003])	0	-
U _B	Uncertainty evaluation based on analytical budget of each uncertainty contribution [ISO GUM, 2008]	1	1
U _C	Uncertainty evaluation based on the experience of the participant (ISO 15530 series under development)	3	3, 5, 6
U _D	Uncertainty evaluation based on CT machine manufacture directions (ISO 15530 series under development)	1	2
U _E	Unknown methods	1	4

The distribution of the selected uncertainties, frequency and their agreement to the reference values are shown in Figure 33 for Item 1 and Figure 34 for Item 2.

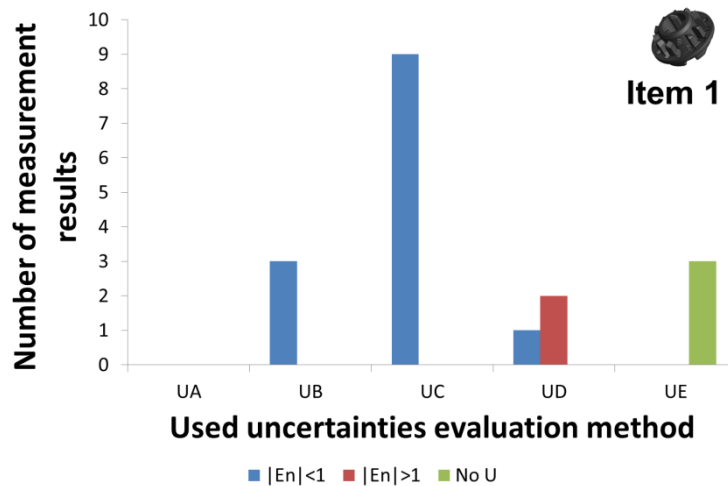

Figure 33: Distribution of the selected uncertainties, frequency and their agreement to the reference values for Item 1.

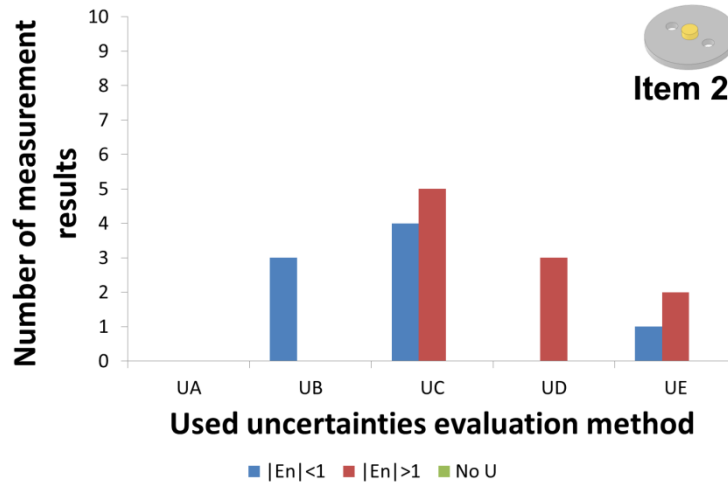

Figure 34: Distribution of the selected uncertainties, frequency and their agreement to the reference values for Item 2.

5.9. Temperature compensation

First at all it is known that the temperature only will influence on the cases of diameters and heights for Item 1 and Item 2. The roundness is not influenced of the thermal expansion. Only participant number 3 and 5 had a temperature approximately to the reference temperature (20.0 °C), see Table 20. It should be stated that participant number 2 had not measured the temperature, but just estimated it. It was clear that it has influenced the main results for the items acquired from participant number 2, as indicated on the graphs in section 5.5 and 5.6. It is due to the thermal expansion and the unknown actual temperature, which contributes to a systematic error of an unknown size. The results in section 5.5 and 5.6 indicate that participant number 2 had underestimated the estimated temperature, where the actual temperature seems to be higher.

Table 20: Participants measuring temperatures.

Participant no.	Temperature [°C]
1	22.8 (calculated average from participant)
2	23.0 (estimated data from participant)
3	20.0
4	-
5	20.3 (calculated average from participant)
6	22.5
Average	21.7

6. Summary and conclusions

- The aim of the Inter laboratory comparison of industrial CT scanners was to collect experience regarding the metrological performance of industrial CT scanning, when measuring small polymers items. The three items had to be considered more similar to industrial parts commonly measured in industry, which are less accurate and stable than reference artefacts.
- The comparison was organized by DTU Department of Mechanical Engineering within the Danish project “CIA-CT: Centre for Industrial Application of CT scanning”.
- The comparison was carried out in the period November 2010 to July 2012 with a concluding workshop planned to be held in September 2012.
- The circulation took place between March 2011 and June 2011.
- The intercomparison involved six participants from Denmark and Germany.
- In this report the participants are anonymous, but each participant has received an identification number.
- The project was based on three items that were sent from one participant to the next one.
- The planning schedules, procedures and reporting instructions were sent to the participants before initiating the circulation.
- Three audit items, similar to common industrial parts, were selected for circulation: a single polymer part with complex geometry (Item 1), a simple geometry part made of two polymers (Item 2) and a miniature step gauge produced using a polymer replica material (Item 3).
- For Item 1 and Item 2 the selected geometrical features were height, diameter and roundness. Item 3 consisted of measurands as bidirectional and unidirectional distances.
- Before, during and at the end of the circulation, the stability of items was investigated and documented.

The main conclusions which were drawn from the project are described in the following:

- Before testing applicability of CT scanning for measurement on the three small polymer items, their stability was investigated. Investigations on the parts’ stability using a tactile Coordinate Measuring Machine (CMM), confirmed that polymers were not stable and change shape and dimensions over time. Stability of Item 1 and Item 2 was verified over a period of eleven months and a maximum deviation of 31 μm was detected for Item 1, when a maximum deviation of 33 μm was detected for Item 2. A significant form error was observed on the surface of Item 2, which influences the definition of the datums and the alignment. A withdrawal of Item 3 was necessary during the proficiency testing, because the material was not hard and stable enough.
- Regarding to the proficiency testing it was important to avoid damages and limit contamination of the items during the circulation phase. Different experiments were made to select the correct sealing box. It was seen that the density of the selected sealing box had an influence on the scanning results. The scanned result becomes better when the density of the sealing box is decreased. This phenomenon is due to the attenuation of the X-rays. The attenuation increases, when the geometrical thickness of the measuring object is increasing. A comparison between with and without sealing box was performed (a low

density sealing box was used, in this case polypropylene) through a scan and the experiment indicates that the difference did not exceed approximately 30 μm .

- Experiences from the participants and testing applicability of CT scanning showed following:
 - The definition of the measurement strategy should be more obvious and protection of the items during the circulation should be improved.
 - Labels on sealing boxes should be considered, because these tend to produce artefacts inside the scan. Therefore it is recommended placing the labels on the sealing boxes, where they cannot generate some noise inside the scan.
 - The used glue to fix the items generates beam hardening problems on the datums and surfaces, because the density of the glue was too close to the densities for Item 1 and Item 2.
 - The sealing boxes reduce the resolution and scanning quality of the items.
 - The interaction of multi materials generates beam hardening problems for Item 2.
- Measurements errors, trends and causes from the participants were the following:
 - There is a trend regarding Item 1, where the measured height by the participants seems to become lower compared to the reference value, with a maximum difference of 11 μm . The reason is that unidirectional measurements are not subject to specific uncertainty components such as threshold determination errors.
 - There is a trend regarding Item 2, where the measured roundness by the participants seems to be higher compared to the reference value, with a maximum difference of 30 μm . The reason was that form measurements were more problematic compared to the size measurements since form measurements are more affected by scatter and noise during the CT scanning process. This results in an overestimation of the form error values by the participants but, surprisingly, this phenomenon was not observed for Item 1. It can be due to the smaller voxel size for Item 1.
 - Most of the deviations from reference values were at the scale of the noise which the sealing box can generate.
- Regarding to the applied uncertainty models, 'Uncertainty evaluation based on the experience of the participant' (ISO 15530 series under development) and 'Uncertainty evaluation based on analytical budget of each uncertainty contribution' gave the best results in terms of agreement with reference measurement results for single polymers (Item 1). For multi materials (Item 2) 'Uncertainty evaluation based on analytical budget of each uncertainty contribution' gave the best results in terms of agreement with reference measurement results.

7. References

- [Angel et al., 2011] J. Angel, A. Cantatore, CIA-CT audit – Inter laboratory comparison of industrial CT scanners, Protocol and measurement procedures, Department of Mechanical Engineering, Technical University of Denmark, 2011.
- [Angel et al., 2012] J. Angel, A. Cantatore, CIA-CT audit – Inter laboratory comparison of industrial CT scanners, Reference measurements report, Department of Mechanical Engineering, Technical University of Denmark, 2012.
- [Bauer et al., 2005] F. Bauer, S. Denner, M. Willert-Porada, Influence of temperature and humidity on the mechanical properties of Nafion® 117 polymer electrolyte membrane, Journal of Polymer Science Part B: Polymer Physics Volume 43, wassue 7, pages 786–795, 1 April 2005, DOI: 10.1002/polb.20367.
- [Cantatore et al., 2010] A. Cantatore, L. De Chiffre, S. Carmignato, Investigation on a replica step gauge for optical 3D scanning of micro parts, Department of Mechanical Engineering, Technical University of Denmark, Proceedings of the euspen International Conference – Delft - June 2010.
- [Carmignato et al., 2011] S. Carmignato, A. Pierobon, E. Savio, CT Audit Interlaboratory Comparison of CT Systems for Dimensional Metrology. Project report, University of Padova, Italy, 2011.
- [De Chiffre et al., 2004] L. De Chiffre, H. N. Hansen, R. E. Morace, CIRP Interlaboratory Comparison of Coordinate Measuring Machines using an Optomechanical Hole Plate, Publication no. IPL.141.04 (MM04.40), DTU, Technical University of Denmark, November 2004.
- [De Chiffre et al., 2009] L. De Chiffre, S. Carmignato, A. Cantatore, J. D. Jensen, Replica calibration artefacts for optical 3D scanning of micro parts, Department of Mechanical Engineering, Technical University of Denmark, Proceedings of the euspen International Conference – San Sebastian - June 2009.
- [De Chiffre, 2011] L. De Chiffre, Geometrical Metrology and Machine Testing, Textbook, Chapter 2 and 4, 2011, Poly Teknisk Forlag, Kgs. Lyngby

-
- [Hansen et al., 1996] H. N. Hansen, L. De Chiffre, Nordic Audit of Coordinate Measuring Machines, EUROMET Project No 330, Nordic Industrial Fund Project No P93046, Technical University of Denmark, May 1996.
- [ISO 14253-2, 2011] ISO 14253-2:2011, Geometrical product specifications (GPS) -- Inspection by measurement of workpieces and measuring equipment -- Part 2: Guidance for the estimation of uncertainty in GPS measurement, in calibration of measuring equipment and in product verification.
- [ISO/IEC 17043, 2010] ISO/IEC 17043:2010, Conformity assessment, General requirements for proficiency testing.
- [ISO TS 15530-3, 2011] ISO TS 15530-3:2011, Geometrical Product Specifications (GPS), Coordinate measuring machines (CMM): Technique for determining the uncertainty of measurement, Part 3: Use of calibrated workpieces or standards.
- [ISO/TS 15530, 2003] ISO/TS 15530 "Geometrical Product Specifications (GPS) – Coordinate measuring machines (CMM) – Part 3 – Techniques for evaluation of measurement uncertainty, 2003.
- [ISO GUM, 2008] ISO (International Organization for Standardization), GUM (Guideline to the Expression of Uncertainty in Measurement), 2008.
- [Ketcham et al., 2001] R. A. Ketcham, W. D. Carlson, Acquisition, optimization and interpretation of X-ray computed tomographic imagery: applications to the geosciences, Computers & Geosciences 27 (2001) 381–400.
- [Kruth, 2010] J. P. Kruth, Invited keynote speech, 14th CMM Danish users' club conference on "Application of CT scanning in industry", DTU, June 8th, (2010).
- [Müller, 2010] P. Müller, Technology, Applications and Limitations of CT Scanning as a Tool for Industrial Measurements, Special course on CT scanning, DTU, (2010).
- [Nielsen, 2004] H. S. Nielsen, Experience Gained from Offering Accredited 3rd Party Proficiency Testing, 2004 NCSL International Workshop & Symposium, HN Proficiency Testing, Inc.
-

-
- [Simon et al., 2007] M. Simon, I. Tiseanu, Ch. Sauerwein, S. M. Yoo, I. S. Cho, Development of multi sensor and multi source computed tomography systems, International Symposium on Digital industrial Radiology and Computed Tomography (June 25-27, 2007) Lyon, France.
- [3D-CT A/S, 2012] J. Angel, A. Cantatore, CIA-CT audit – Inter laboratory comparison of industrial CT scanners, Confidential participant report for 3D-CT A/S, Department of Mechanical Engineering, Technical University of Denmark, 2012.
- [Brock & Michelsen A/S, 2012] J. Angel, A. Cantatore, CIA-CT audit – Inter laboratory comparison of industrial CT scanners, Confidential participant report for Brock & Michelsen A/S, Carl Zeiss Industrielle Messtechnik GmbH, Department of Mechanical Engineering, Technical University of Denmark, 2012.
- [Danish Technological Institute, 2012] J. Angel, A. Cantatore, CIA-CT audit – Inter laboratory comparison of industrial CT scanners, Confidential participant report for Danish Technological Institute, Metrology and Quality Assurance, Department of Mechanical Engineering, Technical University of Denmark, 2012.
- [Novo Nordisk A/S, Device R&D, 2012] J. Angel, A. Cantatore, CIA-CT audit – Inter laboratory comparison of industrial CT scanners, Confidential participant report for Novo Nordisk A/S, Device R&D, Department of Mechanical Engineering, Technical University of Denmark, 2012.
- [Novo Nordisk A/S, DMS Metrology and Calibration, 2012] J. Angel, A. Cantatore, CIA-CT audit – Inter laboratory comparison of industrial CT scanners, Confidential participant report for Novo Nordisk A/S, DMS Metrology and Calibration, Department of Mechanical Engineering, Technical University of Denmark, 2012.
- [Zebicon A/S, 2012] J. Angel, A. Cantatore, CIA-CT audit – Inter laboratory comparison of industrial CT scanners, Confidential participant report for Zebicon A/S, Department of Mechanical Engineering, Technical University of Denmark, 2012.
-

8. Appendix

Analysis of participants' data – Item 3

The analysis of participants' data for Item 3 is collected here.

Used industrial CT scanners, software and conducted measurements

As indicated in Table 21, all the participants measured Item 3.

Table 21: Conducted measurements by the participants.

Item	Number of CT systems that measured	Number of CT systems that did not measure	Total number of CT systems
Item 3	6	0	6

Applied voxel sizes

The average voxel size for Item 3 was 49.7 μm .

Table 22: Applied voxel sizes by the participants.

Participant no.	Voxel size for Item 3 [μm]
1	19.0 to 42.0
2	47.0
3	57.7
4	-
5	54.0 (no scale correction)
6	59.2
Average	49.7

Problems reported by the participants

Some problems were detected by the participants during the circulation phase. The most general problems were that:

- The definition of the measurement strategy should be changed. In CT scanning nobody will take only 8 points on a plane. Instead minimum 500 points is required followed by a filtering with a suitable filter. Single point probing is for CMMs where large radius balls are used (>8mm). The risk of probing on either an insignificant pollution or scratch (see Figure 35) is too big. But if the operator is searching for extreme values, then the filter must not be applied.
- Item 3 can be measured with a better magnification if the part is mounted directly on a Styrofoam without the plastic around the part, see Figure 36. With a better fixture the voxel size can be reduced to 25 or 30 μm . The integration time, the voltage and the current can also be reduced if the beam has to penetrate only one material.

The edges on the ref surface 4 to 6 can influence the result.
The surface A is deformed.

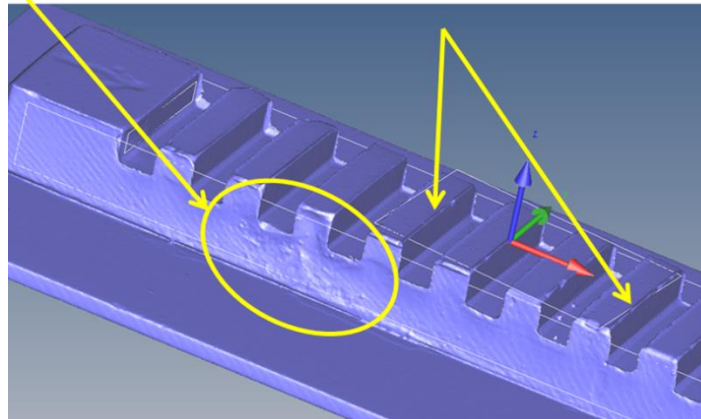
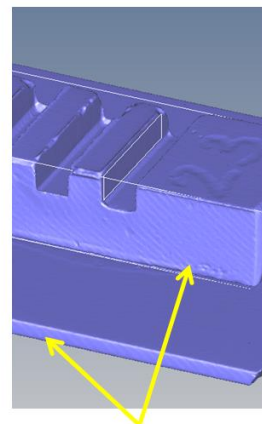
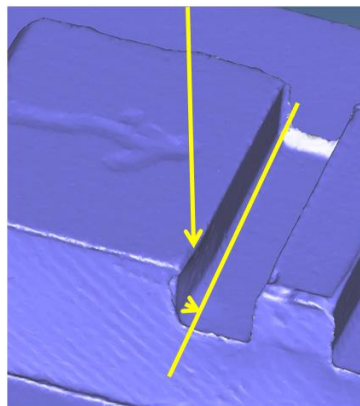

Figure 35: Example from participant number 6, where the edges on the reference surface 4 to 6 can influence the result. Furthermore surface A is deformed. For further information of the location of the surfaces/datums see [Angel et al., 2011].

The surface C is deformed.



The density of the material used to mount the part is higher than the part itself.

Figure 36: Example from participant number 6, where the surface C is deformed. Furthermore the density of the material used to mount Item 3 is higher than the part itself. For further information of the location of the surfaces/datums see [Angel et al., 2011].

Main results for Item 3

Main results are acquired and compared among the participants for the measurands; unidirectional and bidirectional distances for Item 3 in Figure 37, Figure 38, Figure 39 and Figure 40. There is a trend for the case of unidirectional distances for Item 3, where the measured distance by the participants seems to be higher compared to the reference value, with a maximum difference of 12 μm . This trend fits to a trend for lengths stated in [Carmignato et al., 2011], where the measured

lengths were longer compared to the reference values. Furthermore there is a trend for the case of bidirectional distances for Item 3, where the measured distance by the participants seems to be lower compared to the reference value, with a maximum difference of 65 μm . The reason for the bigger difference between the reference values and participants results for bidirectional distances is that unidirectional sizes are less problematic than bidirectional measurements [Carmignato et al., 2011]. It is because unidirectional measurements are not subject to specific uncertainty components such as threshold determination errors.

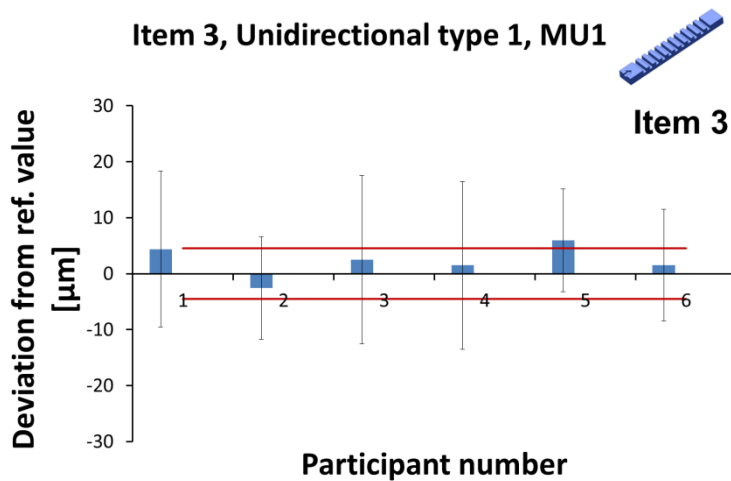

Figure 37: Deviation chart comparing the results obtained from all the participants Item 3 in the case of unidirectional distances (type 1). The red lines indicate the maximum reference uncertainty.

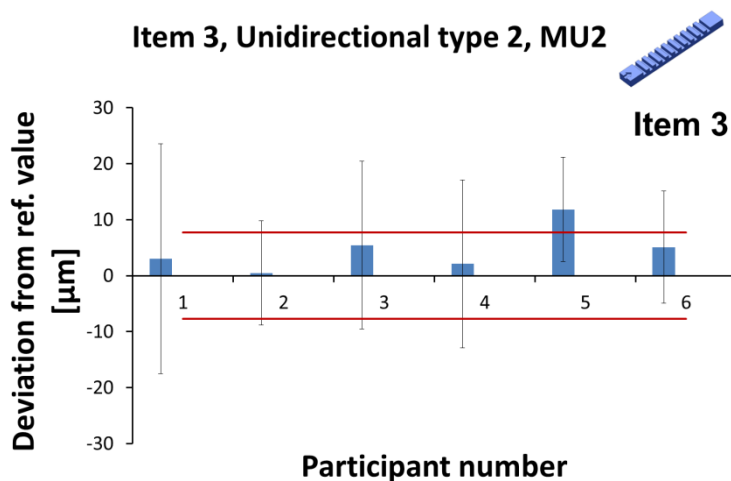

Figure 38: Deviation chart comparing the results obtained from all the participants Item 3 in the case of unidirectional distances (type 2). The red lines indicate the maximum reference uncertainty.

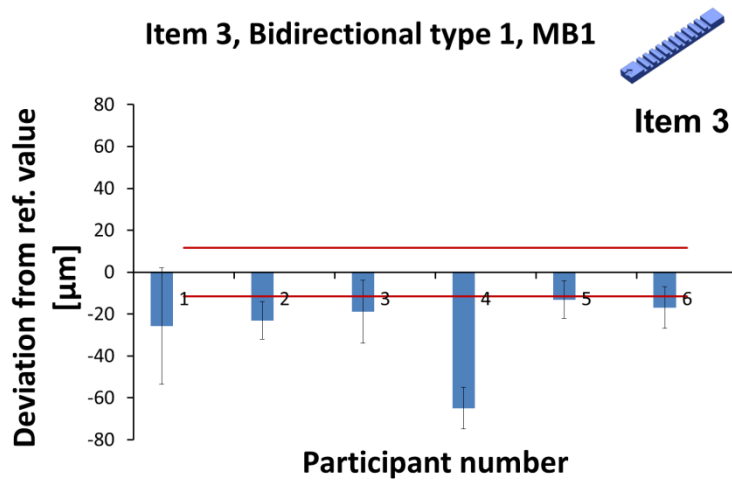

Figure 39: Deviation chart comparing the results obtained from all the participants Item 3 in the case of bidirectional distances (type 1). The red lines indicate the maximum reference uncertainty.

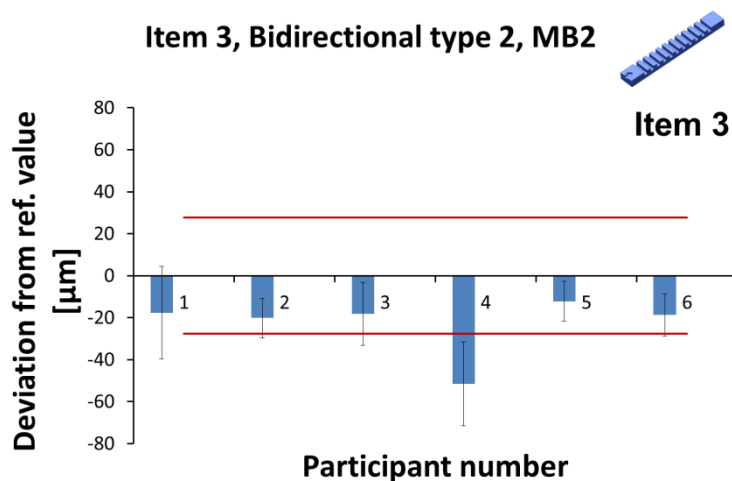

Figure 40: Deviation chart comparing the results obtained from all the participants Item 3 in the case of bidirectional distances (type 2). The red lines indicate the maximum reference uncertainty.

Analysis of the agreement between main results and reference measurement results

The reference values from February 2011 were used as reference measurement results. Results are shown in Figure 41. From the intercomparison, unidirectional sizes are less problematic than bidirectional measurements. It is because unidirectional measurements are not subject to specific uncertainty components such as threshold determination errors.

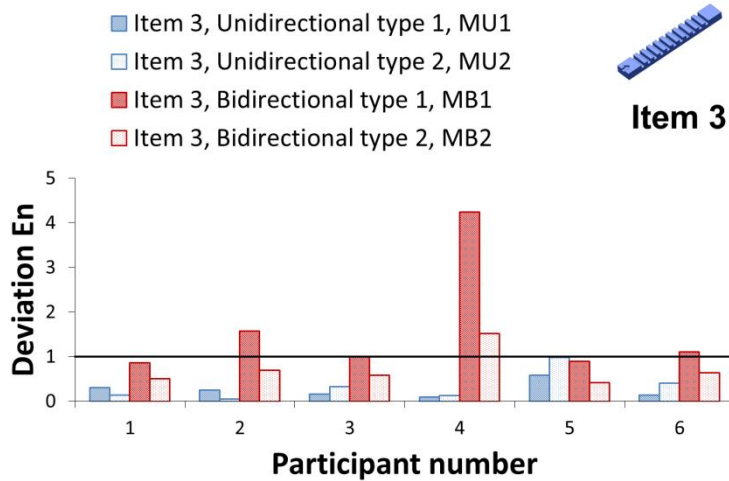

Figure 41: E_n chart comparing the results obtained from all the participants for Item 3 for all cases of measurands. A value of $E_n < 1$ assures agreement with reference measurement results.

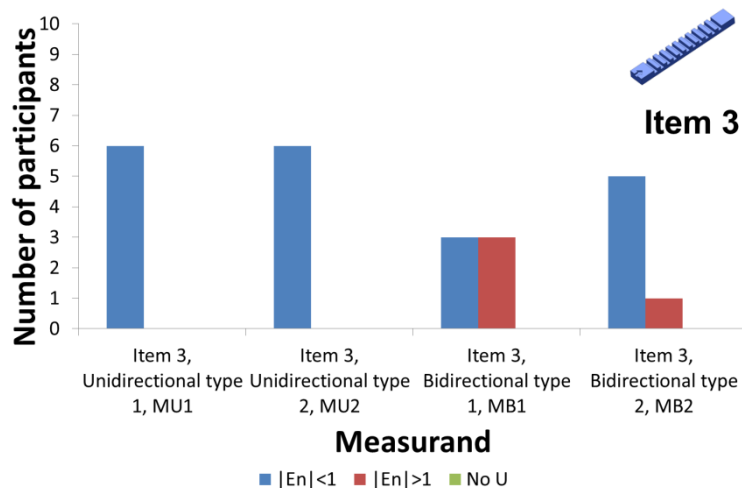

Figure 42: E_n chart showing the distribution of results, which were in agreement with reference measurement results for Item 3.

A histogram showing the distribution of all E_n values acquired from Item 1, Item 2 and Item 3 (when Item 3 is included) is shown in Figure 43 and the distribution in percentage is shown in Table 23 . About 68 % of the main results for Item 1, Item 2 and Item 3 are in agreement with the reference measurement results.

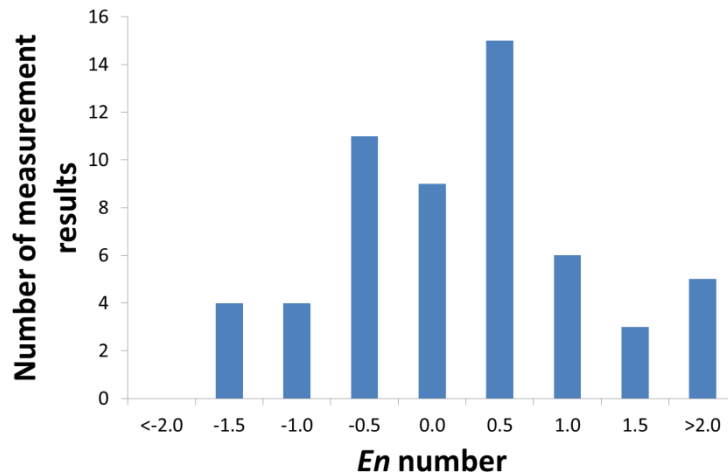

Figure 43: Histogram for the distribution of all E_n values acquired for Item 1, Item 2 and Item 3.

Table 23: Overview of the distribution of E_n values in percentage.

Type of measurement results	Number of measurement results	Percentage [%]
$ E_n < 1$	41	68.3
$ E_n > 1$	16	26.7
Without uncertainty statement	3	5.0
TOTAL	60	100.0

Outline of the applied uncertainties by the participants

Outlines of the applied uncertainties by the participants are described in Table 24 for Item 3. Participants number 3, 5 and 6 used 'Uncertainty evaluation based on the experience of the participant' (ISO 15530 series under development). Participant number 1 used 'Uncertainty evaluation based on analytical budget of each uncertainty contribution' [ISO GUM, 2008]. Participant number 2 used 'Uncertainty evaluation based on CT machine manufacture directions' (ISO 15530 series under development). Participant number 4 had indicated an uncertainty value for the measured data for Item 3, but no information of the applied uncertainty was stated and it was therefore indicated as unknown in Table 24. For Item 3 'Uncertainty evaluation based on the experience of the participant (ISO 15530 series under development) and 'Uncertainty evaluation based on analytical budget of each uncertainty contribution [ISO GUM, 2008]' gave the best results related to the agreement with reference measurement results.

Table 24: Outline of what uncertainty method was applied by the participants and the frequency of the given uncertainty.

Abbreviation for the applied uncertainty	Used uncertainties evaluation method	Frequency	Participant no.
U _A	Uncertainty evaluation based on the substitution method (ISO 15530 part 3 [ISO/TS 15530, 2003])	0	-
U _B	Uncertainty evaluation based on analytical budget of each uncertainty contribution [ISO GUM, 2008]	1	1
U _C	Uncertainty evaluation based on the experience of the participant (ISO 15530 series under development)	3	3, 5, 6
U _D	Uncertainty evaluation based on CT machine manufacture directions (ISO 15530 series under development)	1	2
U _E	Unknown methods	1	4

The distribution of the selected uncertainties, frequency and their agreement to the reference values are shown in Figure 44 for Item 3.

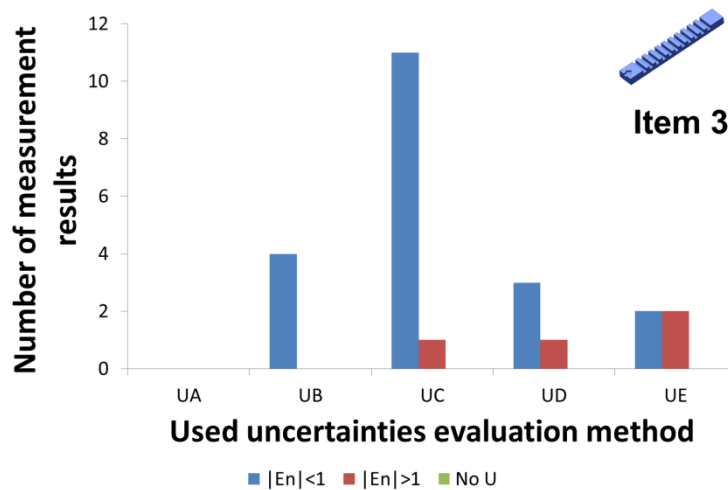

Figure 44: Distribution of the selected uncertainties, frequency and their agreement to the reference values for Item 3.